

**SINGER**  
103W2,W3

# LIST OF PARTS

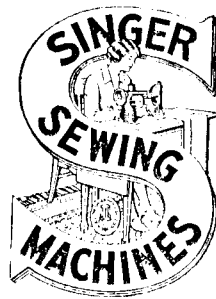

## MACHINES Nos. 103w2 and 103w3

THE SINGER MANUFACTURING COMPANY

### INDEX

	PAGE
ACCESSORIES .....	26
ROBBIN WINDER .....	26
FOOTINGS FOR VARIOUS KINDS OF HATS .....	28
MACHINE No. 103w2 .....	7
"    "    103w3 .....	17
NUMERICAL LIST OF PARTS .....	31
TREADLE .....	27

# Instructions for Ordering

In ordering from this list, use **ONLY** the **PART** number in the **FIRST** column.

The number stamped on a Sewing Machine Part is the number of the Single Part only, except when the part includes Set Screws, Clamping Screws, Studs and Rollers Spun on, Small Wires riveted, or Parts soldered together, etc., which it is necessary to furnish in combination.

Every combination of parts sent out has its specific number which, although not stamped on Parts (except in above case), must be used when ordering the combination.

Each number always indicates the **SAME PART** in whatever list it appears, or for whatever Machine.

The letters after some of the numbers indicate the style of finish only, as follows:

- A. Hardened, Polished and Plated.
- B. Polished and Plated.
- C. Hardened only.
- D. Polished only.
- E. Soft, not polished.
- F. Hardened and Polished.
- H. Blued.
- J. Nickel Plated only.
- R. Merlized.
- Y. Black Nickel Plated only.

These letters **MUST BE USED** when they appear in the list and **AFTER** the number, as in the list.

In this series

- 200001 to 201500 and 350001 to 351500 are Screw Numbers.
- 201501 to 201800 and 351501 to 351800 are Nut Numbers.
- 201801 to 202000 and 350801 to 352000 are Roller Numbers.
- 202001 to 350000 are Numbers of Machine Parts.

The figures in the second column refer only to the plate in which the illustration of the part is shown and are **NOT TO BE USED** in ordering.

Two or more numbers over a cut indicate that the difference between such parts is not visible in an illustration.

Parts marked with an asterisk (\*) are furnished only when repairs are made at the factory.

## LIST OF PARTS COMPLETE

FOR

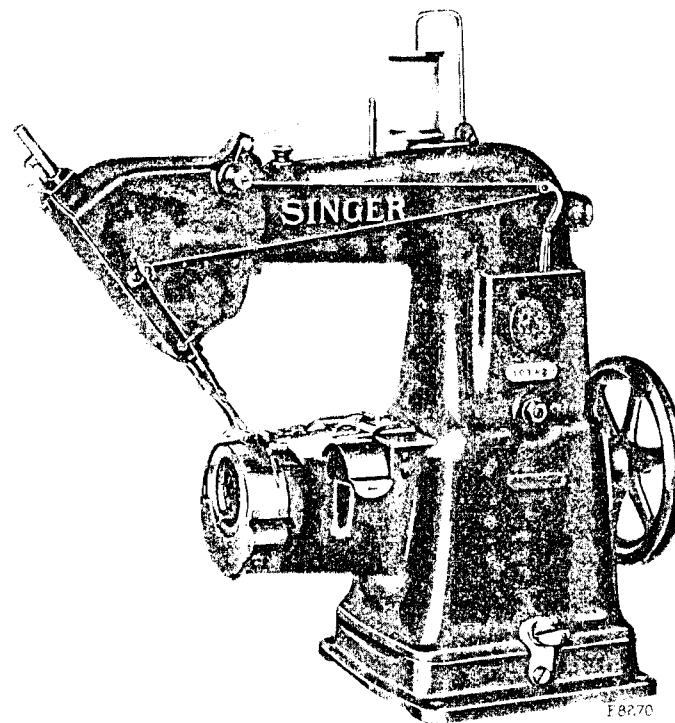

## MACHINE No. 103w2

WHEEL FEED. MOVABLE HEAD

For Sewing a Sweat Leather with Reed or Wire Attached, into Stiff, Soft or Straw Hats

Makes stitches alternately  $\frac{3}{16}$  and  $\frac{1}{8}$  inch long

No.	Plate	Name
*208081		Arm Head .....
208082	12412	" " Collar with 200361c ....
200364c	12413	" " " Set Screw .....
208083	12403	" " Friction Disc (rawhide)
208084	12403	" " " " Follower
208085	12403	" " " " " "
		Spring .....

No.	Plate	Name
200949b	12410	Arm Head Friction Disc Follower Spring Adjusting Screw .....
208232	12412	Arm Head Friction Washer .....
208087	12406	" " Lock Pin .....
208088	12423	" " " " Releasing Bracket with 200051e .....
200051e	12411	Arm Head Lock Pin Releasing Bracket Clamping Screw .....
208089	12412	Arm Head Lock Pin Socket .....
225547	12406	" " " " Spring .....
200372c	12411	" " " " " Retain ing Screw .....
200062n	12411	Arm Head Screw .....
208239	12423	" " Stop with 200986c and 201612c .....
200986c	12413	Arm Head Stop Adjusting Screw ..
201612c	12413	" " " " " Nut
208238	12413	" " " " Plate .....
202602	12423	" " " " Pin (2) .....
200089e	12411	" " " " Screw (2) .....
200157b	12410	" " " " (2) .....
208113	- -	" and Bed (one piece) .....
208114	- -	" " " Base .....
203184	12408	" " " " Clamp .....
200262n	12410	" " " " " Hinge Screw .....
202622	12408	Arm and Bed Base Clamp Hinge Screw Washer .....
208115	12415	Arm and Bed Base Hinge .....
200030n	12408	" " " " " Screw (6)
200728b	12405	" " " " " Wing Screw
203185	12408	" " " " " " " Washer .....
208116	- -	Arm and Bed Side Cover .....
202602	12423	" " " " " Position Pin .....
213710	12408	Bobbin .....
*208075	- -	" Case Body with 2523 and 208134 .....
15141	12423	Bobbin Case Hinge, Nos. 2973, 2974 and 15140 .....
15140	12408	Bobbin Case Latch .....
2973	12408	" " " " Lever .....
2974	12408	" " " " " Fulcrum Pin .....

No.	Plate	Name
210736	12408	Bobbin Case Latch Spring .....
208134	- -	" " " " Position Finger .....
2523	- -	" " " " " Rivet ..
592c	12408	" " " " Stop Screw .....
208135	- -	" " " " Stud .....
15278	12423	" " " " Tension Spring .....
591e	12408	" " " " " Screw
208076	12423	Bobbin Case complete, Nos. 591e, 592c, 15141, 15278, 208075 and 210736 .....
208094	12416	Cylinder End Plate .....
200582n	12410	" " " " Screw (3) .....
208095	12415	Driving Shaft .....
208096	12416	" " " " Bushing .....
200747c	12411	" " " " " Set Screw ..
208059	12424	" " " " Crank with 200335c, 200431c, 200669c and 201530c ..
208098	12415	Driving Shaft Crank Cover .....
200577n	12410	" " " " " " Screw (2) .....
200431c	12411	Driving Shaft Crank Position Screw
200335c	12413	" " " " " Set Screw .....
200669c	12411	" " " " " Stud .....
201530c	12410	" " " " " Nut .....
200062n	12411	" " " " Thrust Screw .....
208099	12419	" " " " Wheel with 200352c and 200363c .....
200352c	12411	Driving Shaft Wheel Position Screw
200363c	12411	" " " " " Set Screw .....
208100	12415	Face Plate .....
200100b	12410	" " " " Screw .....
200669c	12410	" " " " Thumb Screw .....
208101	12423	Feed Cam with 200362c and 200437c
200437c	12411	" " " " Position Screw .....
200362c	12411	" " " " Set Screw .....
208058	12424	" Fork Connection with 200029c
200029c	12423	" " " " Pinch Screw ..
208102	12415	" Rock Shaft with 208106 .....
208104	12403	" " " " Pawl .....
200942b	12410	" " " " " Hinge Screw
201528c	12410	" " " " " " " " Nut .....
208105	12403	Feed Rock Shaft Pawl Spring .....
200271b	12410	" " " " " " Screw
208106	12413	" " " " " " " Stop Pin .....
203244	12406	Feed Rock Shaft Thrust Collar with two 200393c .....
200393c	12413	Feed Rock Shaft Thrust Collar Set Screw .....

No.	Plate	Name
208107	----	Feed Rock Shaft complete, Nos. 200274b, 200942b, 201528e and 208103 to 208105 .....
208108	12416	Feed Wheel .....
208216	----	" " 208108 with 208163 and three 200580c .....
208214	12403	Feed Wheel Friction Spring .....
202062	12412	" " " " Position Pin .....
208109	12403	Feed Wheel Retaining Clutch .....
208110	12403	" " " " Spring .....
200386c	12410	" " " " " Screw .....
208111	12416	Feed Wheel Yoke with 200956c and 202062 .....
208112	----	Feed Wheel complete, Nos. 200386c, 208109 to 208111, 208214 and 208216 .....
200956c	12411	Feed Wheel Yoke Clamping Screw .....
200948c	12410	" " " Hinge Screw .....
200953c	12410	" " " Raising Screw .....
201520n	12410	" " " " Nut .....
200405c	12410	" " " Set Screw .....
201520n	12410	" " " " Nut .....
208118	12416	Foot Lifter Bell Crank .....
200973n	12416	" " " " Hinge Screw .....
200666c	12410	" " " " Stop Screw .....
208119	12415	Guide Bracket with 200334c and 201533n .....
200100e	12410	Guide Bracket Screw (2) .....
208120	12409	" Plate with 208126 and two 208127 .....
200187b	12409	Guide Plate Adjusting Screw .....
228043	12409	" " " " Washer .....
208122	12409	" " Reed Guide (adjustable) .....
208123	12409	" " Stay Guide (adjustable) .....
208124	12409	" " " " Adjusting Lever .....
200305b	12409	Guide Plate Stay Guide Adjusting Lever Hinge Screw .....
201537n	12423	Guide Plate Stay Guide Adjusting Lever Hinge Screw Nut .....
208125	12409	Guide Plate Stay Guide Adjusting Lever Link .....
200952b	12409	Guide Plate Stay Guide Adjusting Lever Link Hinge Screw .....
208126	12423	Guide Plate Stay Guide Adjusting Lever Stop .....
208127	12401	Guide Plate Stay Guide Adjusting Lever Stop Pin .....

No.	Plate	Name
200952b	12409	Guide Plate Stay Guide Screw .....
208128	12409	" " Swing Plate .....
208240	----	Guide complete, Nos. 200187b, 200305b, 201537e, 208120, 208122 to 208125, 208128, 228043 and four 200952b .....
200334c	12411	Guide Swing Plate Adjusting Screw .....
201533n	12423	" " " " " Nut .....
200268b	12410	Guide Swing Plate Hinge Screw .....
226467	12409	" " " " " Washer .....
208130	----	Guide Bracket and Guide complete, Nos. 200268b, 208119, 208240, 226467 and two 200100e .....
208131	12408	Hook with 208135 .....
208132	12407	" Bracket with three each 200386c and 204234 .....
208219	----	Hook Bracket 208132 with 208131, 208144, 208145 and two 208248 .....
200386c	12410	Hook Bracket Adjusting Screw .....
200085c	12410	" " Screw (2) .....
208263	12423	" Cover .....
200581n	12410	" " Screw (2) .....
208255	----	" Driver with 208142 .....
208246	----	" " Crank .....
208247	12408	" " " 208246 with 200348c, 200378c, 200440c, 200662c and 201530e .....
204241	12408	Hook Driver Crank Link .....
200440c	12410	" " " Position Screw .....
200348c	12411	" " " Set Screw (long) .....
200378c	12411	" " " " " (short) .....
200662c	12411	" " " Stud .....
201530e	12410	" " " Nut .....
208256	----	" " Needle Guard .....
204243	12423	" " " " Pin .....
201409f	12423	" " " " Screw .....
208142	12423	" " Washer .....
208257	12424	Hook Driver complete, Nos. 201409f, 208255, 208256 and two 204243 .....
208144	12407	Hook Race .....
208145	12407	" " Cap .....
200802e	12407	" " " Screw (short) .....
208248	----	" " " " 200802e with 208146 (2) .....
208146	12407	Hook Race Cap Screw Spring (short) .....
204234	12412	Hook Race Position Pin .....

No.	Plate	Name
208078	12424	Needle Bar with 200125r
208260	12425	" " Bushing (lower)
200399c	12410	" " " " Set Screw
208079	12425	" " " (upper)
200399c	12410	" " " " Set Screw
208080	12425	" " Connection with 202244 and two 200394e
208153	12408	Needle Bar Connection Guide Roller
208154	12405	" " " Hinge Pin
200368H	12413	" " " " " Set Screw
208155	12425	Needle Bar Connection Link (lower)
208210		" " " " 208155 with 200951c, 201525e and 208156
208156	12425	Needle Bar Connection Link (upper)
200951c	12425	" " " " Hinge Screw
201525E	12425	Needle Bar Connection Link Hinge Screw Nut
202244	12414	Needle Bar Connection Oil Pack- ing (wick)
200394c	12413	Needle Bar Connection Set Screw
200960	12411	" " Disengaging Cam Fol- lower Screw Stud
201542c	12411	Needle Bar Disengaging Cam Fol- lower Screw Stud Nut
208158	12416	Needle Bar Disengaging Cam Fol- lower Shaft
208220		Needle Bar Disengaging Cam Fol- lower Shaft 208158 with 208167, 208169 and two 200670c
208159	12412	Needle Bar Disengaging Cam Fol- lower Shaft Spring
208160	12425	Needle Bar Disengaging Cam Fol- lower Shaft Spring Adjusting Col- lar with 200098b
200098b	12410	Needle Bar Disengaging Cam Fol- lower Shaft Spring Adjusting Col- lar Clamping Screw
208160	12425	Needle Bar Disengaging Cam Fol- lower Shaft Stop Collar with 200098b
200098b	12410	Needle Bar Disengaging Cam Fol- lower Shaft Stop Collar Clamp- ing Screw
208162	12406	Needle Bar Disengaging Cam Fol- lower Shaft Stop Collar Washer (rawhide)

No.	Plate	Name
208163	12416	Needle Bar Disengaging Cam Ring
200580c	12410	" " " " " Screw (3)
208164	12412	Needle Bar Disengaging Clutch with 200373c and 208249
208165	12406	Needle Bar Disengaging Clutch Pin
200373c	12413	" " " " " Set Screw
208166	12406	Needle Bar Disengaging Clutch Stud with 202254
208249	12425	Needle Bar Disengaging Clutch Stud Bushing
202254	12412	Needle Bar Disengaging Clutch Stud Oil Packing (wick)
208167	12419	Needle Bar Disengaging Lever
208168	12412	" " " " Hinge Stud (eccentric)
200338c	12411	Needle Bar Disengaging Lever Hinge Stud Set Screw
208169	12405	Needle Bar Disengaging Lever Link
200670c	12405	" " " " " Hinge Screw
200405c	12410	Needle Bar Disengaging Lever Stop Screw
201520H	12410	Needle Bar Disengaging Lever Stop Screw Nut
208173	12417	Needle Bar Driving Connection with 200027c and 201531H
200027c	12411	Needle Bar Driving Connection Screw
201531H	12425	Needle Bar Driving Connection Screw Jam Nut
208170	12416	Needle Bar Driving Crank with 200404c, 201528c and 208250
208224		Needle Bar Driving Crank 208170 with 208164 and 208166
208250	12425	Needle Bar Driving Crank Bushing
200945c	12414	" " " " Hinge Screw
201517c	12411	Needle Bar Driving Crank Hinge Screw Nut
208171	12417	Needle Bar Driving Eccentric with 200362c and 200437c
208244		Needle Bar Driving Eccentric 208171 with 208172, 208173 and two 200578H
208172	12417	Needle Bar Driving Eccentric Cap
200578H	12401	" " " " " Screw

No.	Plate	Name
200437c	12411	Needle Bar Driving Eccentric Position Screw .....
200362c	12411	Needle Bar Driving Eccentric Set Screw .....
208174	12419	Needle Bar Driving Shaft with two 200368u .....
208176	12415	Needle Bar Driving Shaft Bushing (back) .....
200347c	12411	Needle Bar Driving Shaft Bushing (back) Set Screw .....
208175	12416	Needle Bar Driving Shaft Bushing (front) .....
200440c	12410	Needle Bar Driving Shaft Bushing (front) Set Screw .....
200954c	12410	Needle Bar Driving Shaft Clutch Position Set Screw (frame) ....
201520u	12410	Needle Bar Driving Shaft Clutch Position Set Screw Nut .....
208177	12412	Needle Bar Driving Shaft Collar with two 200364c .....
200364c	12413	Needle Bar Driving Shaft Collar Set Screw .....
208086	12412	Needle Bar Driving Shaft Friction Washer .....
200667c	12411	Needle Bar Driving Shaft Position Stud .....
200401c	12411	Needle Bar Driving Shaft Position Stud Set Screw (crank) .....
201528E	12410	Needle Bar Driving Shaft Position Stud Set Screw Nut .....
200062H	12414	Needle Bar Driving Shaft Thrust Screw .....
208077	----	Needle Bar Driving Shaft complete, Nos. 208080, 208153, 208154, 208165, 208174, 208210 and 208224
200125F	12413	Needle Set Screw .....
208181	12417	Presser Bar with 200074E .....
208260	12425	" " Bushing .....
200383c	12425	" " " Set Screw ....
208184	12401	" " Guide with 200048D ..
200048D	12411	" " " Clamping Screw .....
202671	12425	" " Lifter .....
208186	12425	" " " Bracket with 200051E .....
200051E	12411	Presser Bar Lifter Bracket Clamping Screw .....
200293D	12410	Presser Bar Lifter Bracket Hinge Screw .....

No.	Plate	Name
208190	12403	Presser Bar Lifter Bracket Link
200293D	12410	" " " " "
		Hinge Screw .....
200653c	12410	Presser Bar Lifter Hinge Screw ..
208187	12403	" " Lifting Bell Crank
200262U	12410	" " " " "
		Hinge Screw .....
208188	12417	Presser Bar Lifting Bell Crank Rod
201521c	12410	" " " " " "
		Jam Nut .....
201543c	12410	Presser Bar Lifting Bell Crank Rod Swivel Nut .....
208189	12403	Presser Bar Lifting Bell Crank Spring .....
202378	12425	Presser Bar Spring .....
208192	12425	" " " Plunger .....
200492B	12410	" " Thumb Screw .....
208183	12403	" Foot .....
200074E	12401	" " Screw .....
202068	12401	Spool Holder Base .....
200575U	12410	" " " Screw .....
201296	12401	" " Wire .....
200079U	12401	" " " Hinge Screw ....
201297	12418	Spool Holder complete, Nos. 200079U, 202068 and 204296 .....
203962	12406	Tension Disc .....
208194	12406	" Release Lever .....
200260D	12406	" " " Hinge Screw .....
208195	12406	" " Plunger .....
201271	12406	" " Washer .....
214321	12406	" Spring .....
201572B	10881	" " Thumb Nut .....
200947B	12406	" Stud with 208245 .....
208196	12406	" " Extension .....
208245	12425	" " Washer .....
208197	12406	Tension complete, Nos. 200947B, 201572B, 204271, 214321 and two 203962 .....
202112	12401	Thread Guide .....
202571	12401	" " (on Arm) .....
208199	12401	" " (on Arm Head) .....
200171D	12401	" " " " " Screw .....
208200	12401	" Leader Bracket with 208127
208127	12401	" " " Pin .....
200378U	12401	" " " Screw .....
202098	12401	" " Roller .....
214354	12401	" " " Cap .....
200171D	12401	" " " " Screw .....
202084	12401	" " " " " Washer .....
200315E	12401	" " " " " Screw .....

No.	Plate	Name
208202	-----	Thread Leader complete, Nos. 200171b, 200315c, 202084, 202098, 208200 and 214554 .....
202091	12401	Thread Retainer Sleeve .....
202092	12401	" " Spring .....
204058	12401	" " Stud .....
200397h	12410	" " " Set Screw .....
204059	12401	Thread Retainer complete, Nos. 202091, 202092 and 204058 .....
208203	12415	Thread Take-up Bracket with 200061e and 201531a .....
200965c	12405	Thread Take-up Bracket Hinge Screw .....
201510b	12405	Thread Take-up Bracket Hinge Screw Nut .....
205631	12405	Thread Take-up Bracket Hinge Screw Washer .....
201833	12405	Thread Take-up Bracket Roller .....
215232	12405	" " " " Stud .....
200061e	12411	" " " " " Clamp Screw .....
201531h	12425	Thread Take-up Bracket Roller Stud Clamp Screw Nut .....
208204	-----	Thread Take-up Bracket complete, Nos. 201833, 208203 and 215232 .....
208205	12419	Thread Take-up Cam with 200324c and 200424e .....
200424e	12411	Thread Take-up Cam Position Screw .....
200324c	12411	Thread Take-up Cam Set Screw .....
208212	12405	" " Lever with 200317h, 202098, 214312 and two 200172h .....
200157h	12410	Thread Take-up Lever Screw (2) .....
202098	12401	" " Roller .....
214312	12405	" " " Cap .....
200172h	12410	" " " " Screw .....
200317h	12401	" " " " Screw .....
208207	12414	Throat Plate .....
200577h	12410	" " Screw (4) .....
208208	12403	" " Separating Guide .....
200946e	12410	" " " " Hinge Screw .....
208209	12403	Throat Plate Separating Guide Spring .....
200172h	12410	Throat Plate Separating Guide Spring Screw .....
208211	-----	Throat Plate complete, 53 needle hole, for needle sizes 12 and 13, Nos. 200946e, 208207 to 208209 and two 200172h .....

## LIST OF PARTS COMPLETE

FOR

**MACHINE No. 103w3**

WHEEL FEED. MOVABLE HEAD

For Sewing a Sweat Leather with Reed or Wire Attached,  
into Stiff, Soft and Straw Hats

Makes  $\frac{1}{4}$  inch stitches

No.	Plate	Name
208081		Arm Head .....
208082	12412	" " Collar with 200364c .....
200364c	12413	" " " Set Screw .....
208083	12403	" " Friction Disc (rawhide) .....
208084	12403	" " " " Follower .....
208085	12403	" " " " " Spring .....
200949h	12410	Arm Head Friction Disc Follower Spring Adjusting Screw .....
208232	12412	Arm Head Friction Washer .....
208087	12406	" " Lock Pin .....
208088	12423	" " " " Releasing Bracket with 200054e .....
200054e	12411	Arm Head Lock Pin Releasing Bracket Clamping Screw .....
208089	12412	Arm Head Lock Pin Socket .....
225547	12406	" " " " Spring .....
200372c	12411	" " " " " Retaining Screw .....
200062h	12411	Arm Head Screw .....
208239	12423	" " Stop with 200986c and 201612c .....
200986c	12413	Arm Head Stop Adjusting Screw .....
201612c	12413	" " " " " Nut .....
208233	12413	" " " " Plate .....
202602	12423	" " " " Pin (2) .....
200089e	12411	" " " " Screw (2) .....
200157h	12410	" " " " (2) .....
208113		" and Bed (one piece) .....
208111		" " " Base .....
203181	12408	" " " " Clamp .....
200262h	12410	" " " " " Hinge Screw .....



No.	Plate	Name
202622	12408	Arm and Bed Base Clamp Hinge Screw Washer .....
208115	12415	Arm and Bed Base Hinge .....
200030n	12408	" " " " " Screw (6) .....
200728n	12405	" " " " " Wing Screw .....
203185	12408	" " " " " " " Washer .....
208116	-	Arm and Bed Side Cover .....
202602	12423	" " " " " " Position Pin .....
213710	12408	Bobbin .....
*208075	-	" Case Body with 2523 and 208134 .....
15141	12423	Bobbin Case Hinge, Nos. 2973, 2974 and 15140 .....
15140	12408	Bobbin Case Latch .....
2973	12408	" " " " " Lever .....
2974	12408	" " " " " Fulcrum Pin .....
210736	12408	Bobbin Case Latch Spring .....
208134	-	" " " " " Position Finger .....
2523	-	" " " " " " Rivet .....
592e	12408	" " " " " Stop Screw .....
208135	-	" " " " " Stud .....
15278	12423	" " " " " Tension Spring .....
591e	12408	" " " " " " Screw .....
208076	12423	Bobbin Case complete, Nos. 591e, 592e, 15141, 15278, 208075 and 210736 .....
208094	12416	Cylinder End Plate .....
200582n	12410	" " " " " Screw (3) .....
208095	12415	Driving Shaft .....
208096	12416	" " " " " Bushing .....
200347c	12411	" " " " " Set Screw .....
208259	12424	" " " " " Crank with 200335c, 200431c, 200669c and 201530e .....
208098	12415	Driving Shaft Crank Cover .....
200577n	12410	" " " " " " Screw (2) .....
200431c	12411	" " " " " Position Screw .....
200335c	12413	" " " " " Set Screw .....
200669c	12411	" " " " " Stud .....
201530e	12410	" " " " " Nut .....
200062n	12411	" " " " " Thrust Screw .....
208099	12419	Driving Shaft Wheel with 200352c and 200363c .....
200352c	12411	Driving Shaft Wheel Position Screw .....
200363c	12411	" " " " " Set Screw .....

No.	Plate	Name
208100	12415	Face Plate .....
200400c	12410	" " " " " Screw .....
200469n	12410	" " " " " Thumb Screw .....
208264	12423	Feed Cam with 200362c and 200437c .....
200437c	12411	" " " " " Position Screw .....
200362c	12411	" " " " " Set Screw .....
208258	12424	" " " " " Fork Connection with 200029c .....
200029c	12423	" " " " " Pinch Screw .....
208103	12415	" " " " " Rock Shaft with 208106 .....
208265	12423	" " " " " Pawl .....
200942n	12410	" " " " " Hinge Screw .....
201528n	12410	" " " " " " " Nut .....
208105	12403	Feed Rock Shaft Pawl Spring .....
200274n	12410	" " " " " " Screw .....
208106	12413	" " " " " " " Stop Pin .....
200244	12406	Feed Rock Shaft Thrust Collar with two 200203c .....
200335c	12413	Feed Rock Shaft Thrust Collar Set Screw .....
208267	-	Feed Rock Shaft complete, Nos. 200274n, 200942n, 201528n, 208103, 208105 and 208265 .....
208268	12424	Feed Wheel .....
208244	12403	" " " " " Friction Spring .....
202062	12412	" " " " " " Position Pin .....
208109	12403	Feed Wheel Retaining Clutch .....
208110	12403	" " " " " " Spring .....
200386c	12410	" " " " " " " Screw .....
208111	12416	Feed Wheel Yoke with 200956c and 202062 .....
208269	-	Feed Wheel complete, Nos. 200386c, 208109 to 208111, 208244 and 208268 .....
200956c	12411	Feed Wheel Yoke Clamping Screw .....
200948c	12410	" " " " " Hinge Screw .....
200953c	12410	" " " " " Raising Screw .....
201520n	12410	" " " " " " Nut .....
200405c	12410	" " " " " Set Screw .....
201520n	12410	" " " " " " Nut .....
208118	12416	Foot Lifter Bell Crank .....
200973n	12410	" " " " " Hinge Screw .....
200666c	12410	" " " " " " Stop Screw .....
208119	12415	Guide Bracket with 200331c and 201533n .....
200100n	12410	Guide Bracket Screw (2) .....

No.	Plate	Name
208120	12409	Guide Plate with 208126 and two 208127 .....
200187r	12409	Guide Plate Adjusting Screw .....
228043	12409	" " " " Washer .....
208122	12409	" " Reed Guide (adjustable) .....
208123	12409	" " Stay Guide (adjustable) .....
208124	12409	" " " " Adjusting Lever .....
200305r	12409	Guide Plate Stay Guide Adjusting Lever Hinge Screw .....
201537r	12423	Guide Plate Stay Guide Adjusting Lever Hinge Screw Nut .....
208125	12409	Guide Plate Stay Guide Adjusting Lever Link .....
200952r	12409	Guide Plate Stay Guide Adjusting Lever Link Hinge Screw .....
208126	12423	Guide Plate Stay Guide Adjusting Lever Stop .....
208127	12401	Guide Plate Stay Guide Adjusting Lever Stop Pin .....
200952r	12409	Guide Plate Stay Guide Screw ...
208128	12409	" Swing Plate .....
208240	---	Guide complete, Nos. 200187r, 200305r, 201537r, 208120, 208122 to 208125, 208128, 228043 and four 200952r .....
200334c	12411	Guide Swing Plate Adjusting Screw .....
201533r	12423	" " " " " " Nut .....
200268r	12410	Guide Swing Plate Hinge Screw .....
226467	12409	" " " " " " Washer .....
208130	---	Guide Bracket and Guide complete, Nos. 200268r, 208119, 208210, 226467 and two 200100r .....
208131	12408	Hook with 208135 .....
208132	12407	" Bracket with three each 200386c and 204234 .....
208219	---	Hook Bracket 208132 with 208131, 208144, 208145 and two 208248 .....
200386c	12410	Hook Bracket Adjusting Screw ...
200085c	12410	" " " " " " Screw (2) .....
208263	12423	" Cover .....
200581r	12410	" " " " " " Screw (2) .....
208255	---	" Driver with 208142 .....
208246	---	" " Crank .....
208247	12408	" " " 208246 with 200348c, 200378c, 200440c, 200662c and 201530r .....

No.	Plate	Name
204241	12408	Hook Driver Crank Link .....
200440c	12410	" " " " Position Screw .....
200348c	12411	" " " " Set Screw (long) .....
200378c	12411	" " " " " " (short) .....
200662c	12411	" " " " Stud .....
201530r	12410	" " " " Nut .....
208256	---	" " Needle Guard .....
204243	12423	" " " " Pin .....
201409r	12423	" " " " Screw ...
208112	12423	" " Washer .....
208257	12424	Hook Driver complete, Nos. 201409r, 208255, 208256 and two 204243 ..
208144	12407	Hook Race .....
208145	12407	" " Cap .....
200802r	12407	" " " " Screw (short) ...
208248	---	" " " " 200802r with 208146 (2) .....
208146	12407	Hook Race Cap Screw Spring (short) .....
204234	12412	Hook Race Position Pin .....
208078	12424	Needle Bar with 200125r .....
208260	12425	" " Bushing (lower) ....
200399c	12410	" " " " " " Set Screw .....
208079	12425	Needle Bar Bushing (upper) ....
200399c	12410	" " " " " " Set Screw .....
208080	12425	Needle Bar Connection with 202244 and two 200394c .....
208153	12408	Needle Bar Connection Guide Roller .....
208154	12405	" " " " Hinge Pin ...
200368r	12413	" " " " " " Set Screw .....
208155	12425	Needle Bar Connection Link (lower) .....
208210	---	Needle Bar Connection Link 208155 with 200954c, 20125r and 208156 .....
208156	12425	Needle Bar Connection Link (upper) .....
200954c	12425	Needle Bar Connection Link Hinge Screw .....
201525r	12425	Needle Bar Connection Link Hinge Screw Nut .....
202244	12414	Needle Bar Connection Oil Packing (wick) .....
200394c	12413	Needle Bar Connection Set Screw .....
208173	12417	" " Driving Connection with 200027r and 201531r .....
200027r	12411	Needle Bar Driving Connection Screw .....

No.	Plate	Name
201531n	12425	Needle Bar Driving Connection Screw Jam Nut .....
208270	12424	Needle Bar Driving Crank with 200363c and 200439c .....
200945c	12411	Needle Bar Driving Crank Hinge Screw .....
201517c	12411	Needle Bar Driving Crank Hinge Screw Nut .....
200439c	12425	Needle Bar Driving Crank Position Screw .....
200363c	12411	Needle Bar Driving Crank Set Screw .....
208171	12417	Needle Bar Driving Eccentric with 200362c and 200437c .....
208244	---	Needle Bar Driving Eccentric 208171 with 208172, 208173 and two 200578n .....
208172	12417	Needle Bar Driving Eccentric Cap
200578n	12401	" " " " " " Screw .....
200437c	12411	Needle Bar Driving Eccentric Position Screw .....
200362c	12411	Needle Bar Driving Eccentric Set Screw .....
208271	12424	Needle Bar Driving Shaft with two 200368n .....
208272	12424	Needle Bar Driving Shaft Bushing (back) .....
200347c	12411	Needle Bar Driving Shaft Bushing (back) Set Screw .....
208175	12416	Needle Bar Driving Shaft Bushing (front) .....
200440c	12410	Needle Bar Driving Shaft Bushing (front) Set Screw .....
208177	12412	Needle Bar Driving Shaft Collar with two 200364c .....
200364c	12413	Needle Bar Driving Shaft Collar Set Screw .....
208086	12412	Needle Bar Driving Shaft Friction Washer .....
200062n	12411	Needle Bar Driving Shaft Thrust Screw .....
208273	---	Needle Bar Driving Shaft complete, Nos. 208080, 208153, 208154, 208210 and 208271 .....
200125c	12413	Needle Set Screw .....

No.	Plate	Name
208181	12417	Presser Bar with 200074n .....
208260	12425	" " Bushing .....
200383c	12425	" " Set Screw .....
208184	12401	" " Guide with 200048n .....
200048n	12411	" " Clamping Screw .....
202671	12425	" " Lifter .....
208186	12425	" " Bracket with 200051c .....
200051c	12411	Presser Bar Lifter Bracket Clamping Screw .....
200293n	12410	Presser Bar Lifter Bracket Hinge Screw .....
208190	12403	Presser Bar Lifter Bracket Link
200293n	12410	" " " " " " Hinge Screw .....
200653c	12410	Presser Bar Lifter Hinge Screw .....
208187	12403	" " Lifting Bell Crank .....
200262n	12410	" " " " " " Hinge Screw .....
208188	12417	Presser Bar Lifting Bell Crank Rod
201521c	12410	" " " " " " Jam Nut .....
201543c	12410	Presser Bar Lifting Bell Crank Rod Swivel Nut .....
208189	12403	Presser Bar Lifting Bell Crank Spring .....
202378	12425	Presser Bar Spring .....
208192	12425	" " Plunger .....
200492n	12410	" " Thumb Screw .....
208251	12424	" Foot .....
200074c	12401	" " Screw .....
202068	12401	Spool Holder Base .....
200575n	12410	" " " Screw .....
204296	12401	" " Wire .....
200079n	12401	" " " Hinge Screw .....
204297	12418	Spool Holder complete, Nos. 200079n, 202068 and 204296 .....
203962	12406	Tension Disc .....
208194	12406	" Release Lever .....
200260n	12406	" " " Hinge Screw .....
208195	12406	" " Plunger .....
204271	12406	" " Washer .....
214321	12406	" Spring .....
201572n	10881	" " Thumb Nut .....
200947n	12406	" Stud with 208245 .....
208196	12406	" " Extension .....
208245	12425	" " Washer .....
208197	12406	Tension complete, Nos. 200947n, 201572n, 204271, 214321 and two 203962 .....

No.	Plate	Name
202412	12401	Thread Guide .....
202571	12401	" " (on Arm) .....
208199	12401	" " (on Arm Head) .....
200171D	12401	" " " " Screw .....
208200	12401	" Leader Bracket with 208127 .....
208127	12401	" " " Pin .....
200578H	12401	" " " Screw .....
202098	12401	" " Roller .....
214554	12401	" " " Cap .....
200171D	12401	" " " " Screw .....
202084	12401	" " " " Washer .....
200315E	12401	" " " " Screw .....
208202	---	Thread Leader complete, Nos. 200171D, 200315E, 202084, 202098, 208200 and 214554 .....
202091	12401	Thread Retainer Sleeve .....
202092	12401	" " Spring .....
204058	12401	" " Stud .....
200397D	12410	" " " Set Screw .....
204059	12401	Thread Retainer complete, Nos. 202091, 202092 and 204058 .....
208203	12415	Thread Take-up Bracket with 200061E and 201531H .....
200965C	12405	Thread Take-up Bracket Hinge Screw .....
201510D	12405	Thread Take-up Bracket Hinge Screw Nut .....
205634	12405	Thread Take-up Bracket Hinge Screw Washer .....
201833	12405	Thread Take-up Bracket Roller .....
215232	12405	" " " " Stud .....
200061E	12411	" " " " " " Clamp Screw .....
201531H	12425	Thread Take-up Bracket Roller Stud Clamp Screw Nut .....
208204		Thread Take-up Bracket complete, Nos. 201833, 208203 and 215232 .....
208205	12419	Thread Take-up Cam with 200234C and 200124C .....
200424C	12411	Thread Take-up Cam Position Screw .....
200324C	12411	Thread Take-up Cam Set Screw .....
208212	12405	" " Lever with 200317H, 202098, 214312 and two 200172H .....
200157B	12410	Thread Take-up Lever Screw (2) .....
202098	12401	" " Roller .....
214312	12405	" " " Cap .....
200172H	12410	" " " " Screw .....
200317H	12401	" " " " Screw .....

No.	Plate	Name
208274	---	Throat Plate .....
200577H	12410	" " Screw (4) .....
208208	12403	" " Separating Guide .....
200946E	12410	" " " " Hinge Screw .....
208209	12403	Throat Plate Separating Guide Spring .....
200172H	12410	Throat Plate Separating Guide Spring Screw .....
208275	12424	Throat Plate complete, 53 needle hole, for needle sizes 16 and 18, Nos. 200946E, 208208, 208209, 208274 and two 200172H .....

## ACCESSORIES

FOR MACHINE No. 103w2

No.	Plate	Name
213710	12408	Bobbin .....
*225482	-----	" Case Screw Driver Blade ..
*225483	-----	" " " " Handle ..
225497	12418	Bobbin Case Screw Driver com- plete, Nos. 225482 and 225483 ..
126 x3	-----	Needles, six, size 18 .....
41564	12418	Machine Rest Pin (wood) .....
120342	12418	Oiler (copper plated) with 120343
120343	12418	" Spout, 3½ in. long .....
*225484	-----	Screw Driver Blade .....
*225485	-----	" " Handle .....
225498	12418	Screw Driver complete (7¼ in. long), Nos. 225484 and 225485 ..
25537	12418	Screw Driver (machine) .....
202511	12418	Wrench .....
225554	12418	" (steel) .....
126 x7	-----	Needles, six, size 22 (when fitted for straw hats) .....

### BOBBIN WINDER

Swing Automatic, Right Hand

225453	10884	Frame with 202277 and 225438 ..
225454	10884	" Hinge Pin .....
202277	-----	" Oil Packing (wick) .....
225438	10884	" " Well Cap .....
225455	10884	" Spring .....
225456	10884	" " Plunger .....
202473	10885	Pulley with 200380c .....
200380c	12413	" Set Screw .....
225381	10884	Spindle .....
225444	10884	Stop Latch .....
200056E	10884	" " Screw .....
225458	10884	" " Thumb Lever .....
225459	10884	" " " " Hinge Stud
225459	10884	" " " " Joint Stud
202478	10884	" " Trip Lever .....
200299H	10884	" " " " Hinge Screw

No.	Plate	Name
225461	10881	Tension Bracket with 201499b ....
200082b	10881	" " Screw .....
228026	10884	" " " Washer .....
2102	10881	" Disc .....
202407	10881	" Spring .....
201499b	10881	" Stud .....
201572b	10881	" " Thumb Nut .....
225462	10881	Bobbin Winder Tension Bracket complete, Nos. 201572b, 202407, 225461 and two 2102 .....
225433	10885	Bobbin Winder and Tension Bracket Base .....
225382	10885	Universal Bobbin Winder complete, Nos. 200056E, 200082b, 200299H, 202473, 202478, 225381, 225433, 225444, 225453 to 225456, 225458, 225462, 228026, two each 225459 and wood screws ¾ in., No. 12, R.H.B. ....

### TREADLE, SINGLE FOOT (RIGHT)

227610	12419	Treadle, single foot (right) with 200526c .....
227779	12419	Treadle Chain, 48 in. long, with two 202784 .....
227612	12419	Treadle Chain Eye Pin .....
202784	12413	" " " " Hook ....
200526c	12411	" " " " Set Screw
227613	12419	" Shaft .....
227614	12419	" Spring .....
227620	12419	" Stand with four wood screws ¾ in., No. 12 .....
227621	-----	Treadle, single foot (right) and Stand complete, Nos. 227610, 227612 to 227614, 227620 and 227779 .....

### FOR MACHINE No. 103w3

Same as Machine No. 103w2 with the following  
exception:

126 x7	-----	Needle, six, size 22, in place of 126x3 .....
--------	-------	--

## FITTINGS FOR VARIOUS KINDS OF HATS

### FOR STIFF HATS

#### FOR MACHINE No. 103w2

No.	Plate	Name
208108	12416	Feed Wheel .....
208240	---	Guide complete, Nos. 200187a, 200305a, 201537e, 208120, 208122 to 208125, 208128, 228043 and four 200952b .....
208183	12403	Presser Foot .....

#### FOR MACHINE No. 103w3

208268	12424	Feed Wheel .....
208240	---	Guide complete, Nos. 200187a, 200305a, 201537e, 208120, 208122 to 208125, 208128, 228043 and four 200952b .....
208251	12424	Presser Foot .....

### FOR STIFF HATS WITH WIRE REEDED SWEAT

Permits Placing Line of Stitching Higher on Crown

#### FOR MACHINE No. 103w2

208108	12416	Feed Wheel .....
208240	--	Guide complete, Nos. 200187a, 200305a, 201537e, 208120, 208122 to 208125, 208128, 228043 and four 200952b .....
208251	12424	Presser Foot .....
208252	12425	Throat Plate Separating Guide, used in place of 208208 .....

### FOR SOFT HATS

#### FOR MACHINE No. 103w2

No.	Plate	Name
208108	12416	Feed Wheel .....
208243	12414	Presser Foot .....
208242	12414	Stay Guide .....
200466a	12413	" " Screw .....

#### FOR MACHINE No. 103w3

208276	12424	Feed Wheel .....
208277		Feed Wheel complete, Nos. 200386a, 208109 to 208114, 208214 and 208276 .....
208251	12424	Presser Foot .....
208242	12414	Stay Guide .....
200466a	12413	" " Screw .....

### FOR PANAMA HATS

#### FOR MACHINE No. 103w2

208225	12416	Feed Wheel .....
208226	"	" " 208225 with 208163 and three 200580c .....
208240	"	Guide complete, Nos. 200187a, 200305a, 201537e, 208120, 208122 to 208125, 208128, 228043 and four 200952b .....
208183	12403	Presser Foot .....

#### FOR MACHINE No. 103w3

208268	12424	Feed Wheel .....
208240	--	Guide complete, Nos. 200187a, 200305a, 201537e, 208120, 208122 to 208125, 208128, 228043 and four 200952b .....
208183	12403	Presser Foot .....

## FOR STRAW HATS

## FOR MACHINE No. 103w2

No.	Plate	Name
208225	12416	Feed Wheel .....
208226	- -	" " 208225 with 208163 and three 200580c .....
208240	-	Guide complete, Nos. 200187b, 200305g, 201537e, 208120, 208122 to 208125, 208128, 228043 and four 200952b .....
208251	12424	Presser Foot .....

## FOR MACHINE No. 103w3

208268	12424	Feed Wheel .....
208240	-	Guide complete, Nos. 200187b, 200305g, 201537e, 208120, 208122 to 208125, 208128, 228043 and four 200952b .....
208251	12424	Presser Foot .....

## NUMERICAL LIST OF PARTS

### FOR MACHINES

**Nos. 103w2 and 103w3**

## NUMERICAL LIST OF PARTS

No.	Plate	Name
591i	12408	Bobbin Case Tension Spring Screw, for 208076 .....
592i	12408	Bobbin Case Stop Screw, for 208076
2102	10881	" Winder Tension Disc, for 225462 .....
2523		Bobbin Case Position Finger Rivet, for 208075 .....
2973	12408	Bobbin Case Latch Lever, for 45141
2974	12408	" " " Fulcrum Pin, for 45141 .....
45140	12408	Bobbin Case Latch, for 45141 .....
45141	12423	" " Hinge, Nos. 2973, 2974 and 45140, for 208076 .....
45278	12423	Bobbin Case Tension Spring, for 208076 .....
25537	12418	Screw Driver (machine) .....
41564	12418	Machine Rest Pin (wood) .....
120342	12418	Oiler (copper plated) with 120343
120343	12418	" Spout, 3½ in. long, for 120342
200027i	12411	Needle Bar Driving Connection Screw, for 208173 .....
200029i	12423	Feed Fork Connection Pinch Screw, for 208258 .....
200030ii	12408	Arm and Bed Base Hinge Screw, ..
200048ii	12411	Presser Bar Guide Clamping Screw, for 208184 .....
200051i	12411	Arm Head Lock Pin Releasing Bracket Clamping Screw, for 208088 .....
200051ii	12411	Presser Bar Lifter Bracket Clamp ing Screw, for 208186 .....
200056i	10884	Bobbin Winder Stop Latch Screw, for 225382 .....
200061i	12411	Thread Take-up Bracket Roller Stud Clamp Screw, for 208203 ..
200062ii	12411	Arm Head Screw .....
200062ii	12411	Driving Shaft Thrust Screw .....
200062ii	12411	Needle Bar Driving Shaft Thrust Screw .....
200074i	12401	Presser Foot Screw, for 208181 .....
200079ii	12401	Spool Holder Wire Hinge Screw, for 204297 .....
200082ii	10881	Bobbin Winder Tension Bracket Screw, for 225382 .....



No.	Plate	Name
200085c	12410	Hook Bracket Screw .....
200089E	12411	Arm Head Stop Screw .....
200098b	12410	Needle Bar Disengaging Cam Fol- lower Shaft Spring Adjusting Col- lar Clamping Screw, for 208160, ..
200098b	12410	Needle Bar Disengaging Cam Fol- lower Shaft Stop Collar Clamping Screw, for 208160 .....
200100b	12410	Face Plate Screw .....
200100E	12410	Guide Bracket Screw, for 208130 ..
200125F	12413	Needle Set Screw, for 208078 .....
200157B	12410	Arm Head Stop Screw .....
200157B	12410	Thread Take-up Lever Screw ....
200171b	12401	" Guide (on Arm Head) Screw
200171b	12401	" Leader Roller Cap Screw, for 208202 .....
200172u	12410	Thread Take-up Roller Cap Screw, for 208212 .....
200172u	12410	Throat Plate Separating Guide Spring Screw, for 208211 and 208275 .....
200187B	12409	Guide Plate Adjusting Screw, for 208240 .....
200260b	12406	Tension Release Lever Hinge Screw
200262u	12410	Arm and Bed Base Clamp Hinge Screw .....
200262u	12410	Presser Bar Lifting Bell Crank Hinge Screw .....
200268B	12410	Guide Swing Plate Hinge Screw, for 208130 .....
200274b	12410	Feed Rock Shaft Pawl Spring Screw, for 208107 and 208267 .....
200293b	12410	Presser Bar Lifter Bracket Hinge Screw .....
200293b	12410	Presser Bar Lifter Bracket Link Hinge Screw .....
200299u	10884	Bobbin Winder Trip Lever Hinge Screw, for 225382 .....
200305B	12409	Guide Plate Stay Guide Adjusting Lever Hinge Screw, for 208210 ..
200315E	12401	Thread Leader Roller Screw, for 208202 .....
200317u	12401	Thread Take-up Roller Screw, for 208212 .....
200324c	12411	Thread Take-up Cam Set Screw, for 208205 .....
200334c	12411	Guide Swing Plate Adjusting Screw, for 208119 .....
200335c	12413	Driving Shaft Crank Set Screw, for 208259 .....

No.	Plate	Name
200338c	12411	Needle Bar Disengaging Lever Hinge Stud Set Screw, for Ma- chine No. 103w2 .....
200347c	12411	Driving Shaft Bushing Set Screw, ..
200347c	12411	Needle Bar Driving Shaft Bushing (back) Set Screw .....
200348c	12411	Hook Driver Crank Set Screw (long), for 208247 .....
200352c	12411	Driving Shaft Wheel Position Screw, for 208099 .....
200362c	12411	Feed Cam Set Screw, for 208101 and 208264 .....
200362c	12411	Needle Bar Driving Eccentric Set Screw, for 208171 .....
200363c	12411	Driving Shaft Wheel Set Screw, for 208099 .....
200363c	12411	Needle Bar Driving Crank Set Screw, for 208270 .....
200364c	12413	Arm Head Collar Set Screw, for 208082 .....
200364c	12413	Needle Bar Driving Shaft Collar Set Screw, for 208177 .....
200368u	12413	Needle Bar Connection Hinge Pin Set Screw, for 208174 and 208271
200372c	12411	Arm Head Lock Pin Spring Retain- ing Screw .....
200373c	12413	Needle Bar Disengaging Clutch Set Screw, for 208164 .....
200378c	12411	Hook Driver Crank Set Screw (short), for 208247 .....
200380c	12413	Bobbin Winder Pulley Set Screw, for 202473 .....
200383c	12425	Presser Bar Bushing Set Screw ..
200386c	12410	Feed Wheel Retaining Clutch Spring Screw, for 208112, 208269 and 208277 .....
200386c	12410	Hook Bracket Adjusting Screw, for 208132 .....
200392c	12413	Feed Rock Shaft Thrust Collar Set Screw, for 203244 .....
200394c	12413	Needle Bar Connection Set Screw, for 208080 .....
200397u	12410	Thread Retainer Stud Set Screw ..
200399c	12410	Needle Bar Bushing (lower) Set Screw .....
200399c	12410	Needle Bar Bushing (upper) Set Screw .....
200404c	12411	Needle Bar Driving Shaft Position Stud Set Screw (crank), for 208170 .....

No.	Plate	Name
200405c	12410	Feed Wheel Yoke Set Screw .....
200405c	12410	Needle Bar Disengaging Lever Stop Screw, for Machine No. 103w2 ..
200424c	12411	Thread Take-up Cam Position Screw, for 208205 .....
200431c	12411	Driving Shaft Crank Position Screw, for 208259 .....
200437c	12411	Feed Cam Position Screw, for 208101 and 208264 .....
200437c	12411	Needle Bar Driving Eccentric Position Screw, for 208171 .....
200439c	12425	Needle Bar Driving Crank Position Screw, for 208270 .....
200440c	12410	Hook Driver Crank Position Screw, for 208247 .....
200440c	12410	Needle Bar Driving Shaft Bushing (front) Set Screw .....
200466b	12413	Stay Guide Screw .....
200469b	12410	Face Plate Thumb Screw .....
200492b	12410	Presser Bar Thumb Screw .....
200526c	12411	Treadle Chain Eye Pin Set Screw, for 227610 .....
200575h	12410	Spool Holder Base Screw .....
200577h	12410	Driving Shaft Crank Cover Screw .....
200577h	12410	Throat Plate Screw .....
200578h	12401	Needle Bar Driving Eccentric Cap Screw, for 208244 .....
200578h	12401	Thread Leader Bracket Screw ....
200580c	12410	Needle Bar Disengaging Cam Ring Screw, for 208216 and 208226 ...
200581h	12410	Hook Cover Screw .....
200582h	12410	Cylinder End Plate Screw .....
200653c	12410	Presser Bar Lifter Hinge Screw ..
200662c	12411	Hook Driver Crank Stud, for 208247 .....
200666c	12410	Foot Lifter Bell Crank Stop Screw ..
200667c	12411	Needle Bar Driving Shaft Position Stud, for Machine No. 103w2 ..
200669c	12411	Driving Shaft Crank Stud, for 208259 .....
200670c	12405	Needle Bar Disengaging Lever Link Hinge Screw, for 208220 .....
200728b	12405	Arm and Bed Base Wing Screw ..
200802E	12407	Hook Race Cap Screw (short), for 208248 .....
200942d	12410	Feed Rock Shaft Pawl Hinge Screw, for 208107 and 208267 .....
200945c	12411	Needle Bar Driving Crank Hinge Screw .....

No.	Plate	Name
200946c	12410	Throat Plate Separating Guide Hinge Screw, for 208211 and 208275 .....
200947b	12406	Tension Stud with 208245, for 208197 .....
200948c	12410	Feed Wheel Yoke Hinge Screw ..
200949b	12410	Arm Head Friction Disc Follower Spring Adjusting Screw .....
200951c	12425	Needle Bar Connection Link Hinge Screw, for 208210 .....
200952b	12409	Guide Plate Stay Guide Adjusting Lever Link Hinge Screw, for 208240 .....
200952b	12409	Guide Plate Stay Guide Screw, for 208240 .....
200953c	12410	Feed Wheel Yoke Raising Screw ..
200954c	12410	Needle Bar Driving Shaft Clutch Position Set Screw (frame), for Machine No. 103w2 .....
200956c	12411	Feed Wheel Yoke Clamping Screw, for 208111 .....
200960	12411	Needle Bar Disengaging Cam Follower Screw Stud, for Machine No. 103w2 .....
200965c	12405	Thread Take-up Bracket Hinge Screw .....
200973h	12410	Foot Lifter Bell Crank Hinge Screw .....
200986c	12413	Arm Head Stop Adjusting Screw, for 208239 .....
201409E	12423	Hook Driver Needle Guard Screw, for 208257 .....
201499b	10881	Bobbin Winder Tension Stud, for 225461 .....
201510b	12405	Thread Take-up Bracket Hinge Screw Nut .....
201517E	12411	Needle Bar Driving Crank Hinge Screw Nut .....
201520h	12410	Feed Wheel Yoke Raising Screw Nut .....
201520h	12410	Feed Wheel Yoke Set Screw Nut ..
201520h	12410	Needle Bar Disengaging Lever Stop Screw Nut, for Machine No. 103w2 ..
201520h	12410	Needle Bar Driving Shaft Clutch Position Set Screw Nut, for Machine No. 103w2 .....
201521c	12410	Presser Bar Lifting Bell Crank Rod Jam Nut .....
201525c	12425	Needle Bar Connection Link Hinge Screw Nut, for 208210 .....

No.	Plate	Name
201528e	12410	Feed Rock Shaft Pawl Hinge Screw Nut, for 208107 and 208267 .....
201528e	12410	Needle Bar Driving Shaft Position Stud Set Screw Nut, for 208170 .....
201530e	12410	Driving Shaft Crank Stud Nut, for 208259 .....
201530e	12410	Hook Driver Crank Stud Nut, for 208247 .....
201531u	12425	Needle Bar Driving Connection Screw Jam Nut, for 208173 .....
201531u	12425	Thread Take-up Bracket Roller Stud Clamp Screw Nut, for 208203 .....
201533u	12423	Guide Swing Plate Adjusting Screw Nut, for 208119 .....
201537u	12423	Guide Plate Stay Guide Adjusting Lever Hinge Screw Nut, for 208210 .....
201542c	12411	Needle Bar Disengaging Cam Follower Screws Nut, for Machine No. 103w2 .....
201543c	12410	Presser Bar Lifting Bell Crank Rod Swivel Nut .....
201572b	10881	Bobbin Winder Tension Stud Thumb Nut, for 225462 .....
201572b	10881	Tension Spring Thumb Nut, for 208197 .....
201612c	12413	Arm Head Stop Adjusting Screw Nut, for 208239 .....
201833	12405	Thread Take-up Bracket Roller, for 208204 .....
202062	12412	Feed Wheel Friction Spring Position Pin, for 208114 .....
202068	12401	Spool Holder Base, for 204297 .....
202084	12401	Thread Leader Roller Cap Screw Washer, for 208292 .....
202091	12401	Thread Retainer Sleeve, for 204059 .....
202092	12401	" " Spring, for 204059 .....
202098	12401	" Leader Roller, for 208202 .....
202098	12401	" Take-up Roller, for 208212 .....
202244	12414	Needle Bar Connection Oil Packing (wick), for 208080 .....
202254	12412	Needle Bar Disengaging Clutch Stud Oil Packing (wick), for 208166 .....
202277	-	Bobbin Winder Frame Oil Packing (wick), for 225453 .....
202378	12425	Presser Bar Spring .....
202407	10881	Bobbin Winder Tension Spring, for 225462 .....
202412	12401	Thread Guide .....

No.	Plate	Name
202473	10885	Bobbin Winder Pulley with 200380c, for 225382 .....
202478	10884	Bobbin Winder Stop Latch Trip Lever, for 225382 .....
202511	12418	Wrench .....
202571	12401	Thread Guide (on Arm) .....
202602	12423	Arm Head Stop Plate Pin .....
202602	12423	" and Bed Side Cover Position Pin .....
202622	12408	Arm and Bed Base Clamp Hinge Screw Washer .....
202671	12425	Presser Bar Lifter .....
202784	12413	Treadle Chain Eye Pin Hook, for 227779 .....
203184	12408	Arm and Bed Base Clamp .....
203185	12408	" " " " Wing Screw Washer .....
203244	12406	Feed Rock Shaft Thrust Collar with two 200393c .....
203962	12406	Tension Disc, for 208197 .....
204058	12401	Thread Retainer Stud, for 204059 .....
204059	12401	Thread Retainer complete, Nos. 202091, 202092 and 204058 .....
204231	12412	Hook Race Position Pin, for 208132 .....
204241	12408	" Driver Crank Link .....
204243	12423	" " Needle Guard Pin, for 208257 .....
204271	12406	Tension Release Washer, for 208197 .....
204296	12401	Spool Holder Wire, for 204297 .....
204297	12418	Spool Holder complete, Nos. 200079u, 202068 and 204296 .....
205631	12405	Thread Take-up Bracket Hinge Screw Washer .....
*208075	-	Bobbin Case Body with 2523 and 208134, for 208076 .....
208076	12423	Bobbin Case complete, Nos. 5914c, 592e, 15141, 15278, 208075 and 210736 .....
208077	-	Needle Bar Driving Shaft complete, Nos. 208080, 208153, 208154, 208165, 208174, 208210 and 208224, for Machine No. 103w2 .....
208078	12424	Needle Bar with 200125F .....
208079	12425	" " Bushing (upper) .....
208080	12425	" " Connection with 202244 and two 200394c, for 208077 and 208273 .....
*208081	-	Arm Head .....

No.	Plate	Name
208082	12412	Arm Head Collar with 200361c
208083	12403	" " Friction Disc (rawhide)
208084	12403	" " " " Follower
208085	12403	" " " " " "
		Spring
208086	12412	Needle Bar Driving Shaft Friction Washer
208087	12406	Arm Head Lock Pin
208088	12423	" " " " Releasing Bracket with 200051c
208089	12412	Arm Head Lock Pin Socket
208094	12416	Cylinder End Plate
208095	12415	Driving Shaft
208096	12416	" " Rushing
208098	12415	" " Crank Cover
208099	12419	" " Wheel with 200352c and 200363c
208100	12415	Face Plate
208101	12423	Feed Cam with 200362c and 200437c
208103	12415	" Rock Shaft with 208106, for 208107 and 208267
208104	12403	Feed Rock Shaft Pawl, for 208107
208105	12403	" " " " Spring, for 208107 and 208267
208106	12413	Feed Rock Shaft Pawl Spring Stop Pin, for 208103
208107	- - -	Feed Rock Shaft complete, Nos. 200274b, 200942c, 201528E and 208103 to 208105, for Machine No. 103w2
208108	12416	Feed Wheel, for 208216
208109	12403	" " Retaining Clutch, for 208112, 208269 and 208277
208110	12403	Feed Wheel Retaining Clutch Spring, for 208112, 208269 and 208277
208111	12416	Feed Wheel Yoke with 200956c and 202062, for 208112, 208269 and 208277
208112	- -	Feed Wheel complete, Nos. 200386c, 208109 to 208111, 208214 and 208216, for Machine No. 103w2
208113	-	Arm and Bed (one piece)
208114	-	" " " Base
208115	12415	" " " Hinge
208116	-	" " " Side Cover
208118	12416	Foot Lifter Bell Crank
208119	12415	Guide Bracket with 200334c and 201533n, for 208130

No.	Plate	Name
208120	12409	Guide Plate with 208126 and two 208127, for 208240
208122	12409	Guide Plate Reed Guide (adjustable), for 208240
208123	12409	Guide Plate Stay Guide (adjustable), for 208240
208124	12409	Guide Plate Stay Guide Adjusting Lever, for 208240
208125	12409	Guide Plate Stay Guide Adjusting Lever Link, for 208240
208126	12423	Guide Plate Stay Guide Adjusting Lever Stop, for 208120
208127	12401	Guide Plate Stay Guide Adjusting Lever Stop Pin, for 208120
208127	12401	Thread Leader Bracket Pin, for 208290
208128	12409	Guide Swing Plate, for 208240
208130	-	Guide Bracket and Guide complete, Nos. 200268b, 208119, 208240, 226467 and two 200100E
208131	12408	Hook with 208135, for 208219
208132	12407	" Bracket, with three each 200386c and 204234, for 208219
208134	- -	Bobbin Case Position Finger, for 208075
208135	-	Bobbin Case Stud, for 208131
208142	12423	Hook Driver Washer, for 208255
208144	12407	" Race, for 208219
208145	12407	" " Cap, for 208219
208146	12407	" " " Screw Spring (short), for 208248
208153	12408	Needle Bar Connection Guide Roller, for 208077 and 208273
208154	12405	Needle Bar Connection Hinge Pin, for 208077 and 208273
208155	12425	Needle Bar Connection Link (lower), for 208210
208156	12425	Needle Bar Connection Link (upper), for 208210
		Nos. 208158 to 208160, for Machine No. 103w2
208158	12416	Needle Bar Disengaging Cam Follower Shaft, for 208220
208159	12412	Needle Bar Disengaging Cam Follower Shaft Spring
208160	12425	Needle Bar Disengaging Cam Follower Shaft Spring Adjusting Collar with 200098b

No.	Plate	Name
208160	12425	Needle Bar Disengaging Cam Follower Shaft Stop Collar with 200098d .....
208162	12406	Needle Bar Disengaging Cam Follower Shaft Stop Collar Washer (rawhide), for Machine No. 103w2 .....
208163	12416	Needle Bar Disengaging Cam Ring, for 208216 and 208226 .....
208164	12412	Needle Bar Disengaging Clutch with 200373c and 208249, for 208224 ..
208165	12406	Needle Bar Disengaging Clutch Pin, for 208077 .....
208166	12406	Needle Bar Disengaging Clutch Stud with 20225t, for 208224 .....
208167	12419	Needle Bar Disengaging Lever, for 208220 .....
208168	12412	Needle Bar Disengaging Lever Hinge Stud (eccentric), for Machine No. 103w2 .....
208169	12405	Needle Bar Disengaging Lever Link, for 208220 .....
208170	12416	Needle Bar Driving Crank with 200404c, 201528e and 208250, for 208224 .....
208171	12417	Needle Bar Driving Eccentric with 200362c and 200437c, for 208244 .....
208172	12417	Needle Bar Driving Eccentric Cap, for 208244 .....
208173	12417	Needle Bar Driving Connection with 200027e and 201531u, for 208244 .....
208174	12419	Needle Bar Driving Shaft with two 200368d, for 208077 .....
208175	12416	Needle Bar Driving Shaft Bushing (front) .....
208176	12415	Needle Bar Driving Shaft Bushing (back), for Machine No. 103w2 ..
208177	12412	Needle Bar Driving Shaft Collar with two 200364c .....
208181	12417	Presser Bar with 200074e .....
208183	12403	" Foot, for Machine No. 103w2 .....
208184	12401	" Bar Guide with 200048d .....
208186	12425	" " Lifter Bracket with 200051e .....
208187	12403	Presser Bar Lifting Bell Crank ..
208188	12417	" " " " " Rod .....
208189	12403	" " " " " Spring .....
208190	12403	" " Lifter Bracket Link ..
208192	12425	" " Spring Plunger .....

No.	Plate	Name
208194	12406	Tension Release Lever .....
208195	12406	" " Plunger .....
208196	12406	" Stud Extension .....
208197	12406	Tension complete, Nos. 200947b, 201572b, 204271, 214321 and two 203962 .....
208199	12401	Thread Guide (on Arm Head) .....
208200	12401	" Leader Bracket with 208127, for 208202 .....
208202		Thread Leader complete, Nos. 200171b, 200315e, 202084, 202098, 208200 and 214554 .....
208203	12415	Thread Take-up Bracket with 200061e and 201531u, for 208204 ..
208204		Thread Take-up Bracket complete, Nos. 201833, 208203 and 215232 ..
208205	12419	Thread Take-up Cam with 200324c and 200424c .....
208207	12414	Throat Plate, for 208211 .....
208208	12403	" " Separating Guide, for 208211 and 208275 .....
208209	12403	Throat Plate Separating Guide Spring, for 208211 and 208275 ..
208210		Needle Bar Connection Link 208155 with 200951c, 201525e and 208156, for 208077 and 208273 .....
208211		Throat Plate complete, 53 needle hole, for needle sizes 12 and 13, Nos. 200946e, 208207 to 208209 and two 200172b, for Machine No. 103w2 .....
208212	12405	Thread Take up Lever with 200317b, 202098, 214312 and two 200172b ..
208214	12403	Feed Wheel Friction Spring, for 208112, 208269 and 208277 .....
208216		Feed Wheel 208108 with 208163 and three 200580c, for 208112 .....
208219		Hook Bracket 208132 with 208131, 208144, 208145 and two 208248 ..
208220		Needle Bar Disengaging Cam Follower Shaft 208158 with 208167, 208169 and two 200670c, for Machine No. 103w2 .....
208224		Needle Bar Driving Crank 208170 with 208164 and 208166, for 208077 .....
208225	12416	Feed Wheel, for 208226 .....
208226		" " 208225 with 208163 and three 200580c .....

No.	Plate	Name
208232	12412	Arm Head Friction Washer .....
208238	12413	" " Stop Plate .....
208239	12423	" " " with 200986c and 201612c .....
208240	---	Guide complete, Nos. 200187c, 200305a, 201537c, 208120, 208127 to 208125, 208128, 228013 and four 200952a, for 208130 .....
208242	12414	Stay Guide .....
208243	12414	Presser Foot .....
208244	---	Needle Bar Driving Eccentric 208171 with 208172, 208173 and two 200578a .....
208245	12425	Tension Stud Washer, for 200947c
208246	---	Hook Driver Crank, for 208247
208247	12408	" " " 208246 with 200348c, 200378c, 200440c, 200662c and 201630c .....
208248	---	Hook Race Cap Screw 200892c with 208146, for 208249 .....
208249	12425	Needle Bar Disengaging Clutch Stud Bushing, for 208164 .....
208250	12425	Needle Bar Driving Crank Bushing, for 208170 .....
208251	12424	Presser Foot .....
208252	12425	Throat Plate Separating Guide ...
208255	---	Hook Driver with 208142, for 208257
208256	---	" " Needle Guard, for 208257
208257	12424	Hook Driver complete, Nos. 201409c, 208255, 208256 and two 204243 ...
208258	12424	Feed Fork Connection with 200029c
208259	12424	Driving Shaft Crank with 200335c, 200431c, 200669c and 201530c ...
208260	12425	Needle Bar Bushing (lower) .....
208260	12425	Presser Bar Bushing .....
208263	12423	Hook Cover .....
208264	12423	Feed Cam with 200362c and 200437c, for Machine No. 103w3 .....
208265	12423	Feed Rock Shaft Pawl, for 208267...
Nos. 208267 to 208277, for Machine No. 103w3		
208267	---	Feed Rock Shaft complete, Nos. 200274d, 200942b, 201528c, 208103, 208105 and 208265 .....
208268	12424	Feed Wheel, for 208269 .....
208269	---	Feed Wheel complete, Nos. 200386c, 208109 to 208111, 208214 and 208268 .....

No.	Plate	Name
208270	12424	Needle Bar Driving Crank with 200363c and 200439c .....
208271	12424	Needle Bar Driving Shaft with two 200368a, for 208273 .....
208272	12424	Needle Bar Driving Shaft Bushing (back) ... ..
208273	---	Needle Bar Driving Shaft complete, Nos. 208080, 208153, 208154, 208210 and 208271 .....
208274	---	Throat Plate, for 208275 .....
208275	12424	Throat Plate complete, 53 needle hole, for needle sizes 16 and 18, Nos. 200946c, 208208, 208209, 208274 and two 200172a .....
208276	12424	Feed Wheel, for 208277 .....
208277	---	Feed Wheel complete, Nos. 200386c, 208109 to 208111, 208214 and 208276 .....
210736	12408	Robbin Case Latch Spring, for 208076 .....
213710	12408	Robbin .....
214312	12405	Thread Take-up Roller Cap, for 208212 .....
214321	12406	Tension Spring, for 208197 .....
214554	12401	Thread Leader Roller Cap, for 208202 .....
215232	12405	Thread Take-up Bracket Roller Stud, for 208204 .....
215381	10884	Bobbin Winder Spindle, for 225382
225382	10885	Universal Bobbin Winder complete, Nos. 200056c, 200082b, 200299a, 202473, 202478, 225381, 225433, 225444, 225452 to 225456, 225458, 225462, 228026, two each 225459 and wood screws $\frac{1}{4}$ in., No. 12, R.H.B., for 225453 .....
225433	10885	Bobbin Winder and Tension Bracket Base, for 225382 .....
225438	10884	Bobbin Winder Frame Oil Well Cap, for 225453 .....
225444	10884	Bobbin Winder Stop Latch, for 225382 .....
225453	10884	Bobbin Winder Frame with 202277 and 225438, for 225382 .....
225454	10884	Bobbin Winder Frame Hinge Pin, for 225382 .....
225455	10884	Bobbin Winder Frame Spring, for 225382 .....
225456	10884	Bobbin Winder Frame Spring Plunger, for 225382 .....

## Numerical List of Parts

No.	Plate	Name
225458	10884	Bobbin Winder Stop Latch Thumb Lever, for 225382 .....
225459	10884	Bobbin Winder Stop Latch Thumb Lever Hinge Stud, for 225382 ..
225459	10884	Bobbin Winder Stop Latch Thumb Lever Joint Stud, for 225382 ...
225461	10881	Bobbin Winder Tension Bracket with 201499c, for 225462 .....
225462	10881	Bobbin Winder Tension Bracket complete, Nos. 201572c, 202107, 225461 and two 2102, for 225382
*225482	----	Bobbin Case Screw Driver Blade, for 225497 .....
*225483	----	Bobbin Case Screw Driver Handle, for 225497 .....
*225484	----	Screw Driver Blade, for 225498 ...
*225485	----	" " Handle, for 225498 ...
225497	12418	Bobbin Case Screw Driver complete, Nos. 225482 and 225483 ..
225498	12418	Screw Driver complete (7 $\frac{1}{2}$ in. long), Nos. 225484 and 225485 ...
225547	12406	Arm Head Lock Pin Spring .....
225554	12418	Wrench (steel) .....
226467	12409	Guide Swing Plate Hinge Screw Washer, for 208130 .....
227610	12419	Treadle, single foot (right), with 200526c, for 227621 .....
227612	12419	Treadle Chain Eye Pin, for 227621
227613	12419	" Shaft, for 227621 .....
227614	12419	" Spring, for 227621 .....
227620	12419	Treadle Stand with four wood screws $\frac{3}{4}$ in., No. 12, for 227621 ...
227621	----	Treadle, single foot (right) and Stand complete, Nos. 227610, 227612 to 227614, 227620 and 227779 .....
227779	12419	Treadle Chain, 48 in. long, with two 202784, for 227621 .....
228026	10884	Bobbin Winder Tension Bracket Screw Washer, for 225382 .....
228043	12409	Guide Plate Adjusting Screw Washer, for 208240 .....

225461

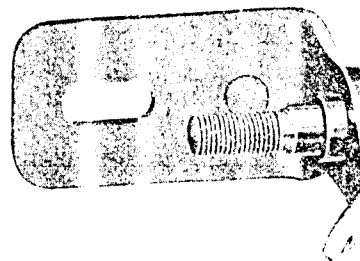

200082 202104



2102

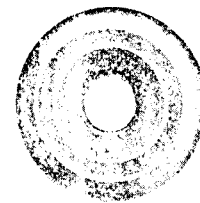

225462

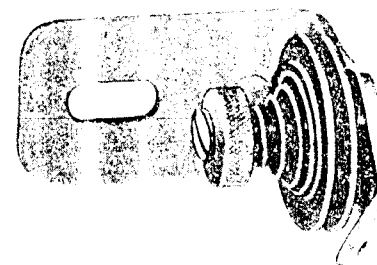

202407



201499



201572



**ILLUSTRATIONS OF PARTS  
FOR  
MACHINES  
Nos. 103w2 and 103w3**



PLATE 10881—FULL SIZE

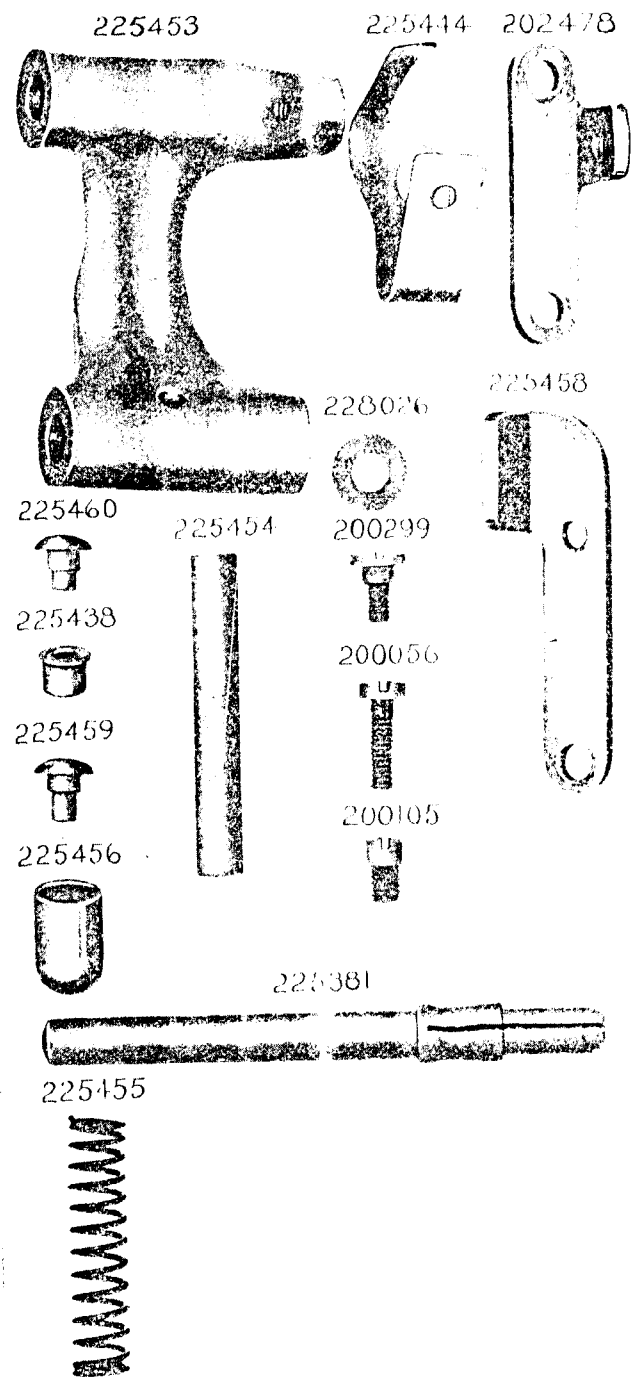

PLATE 10885—ONE-FOURTH SIZE

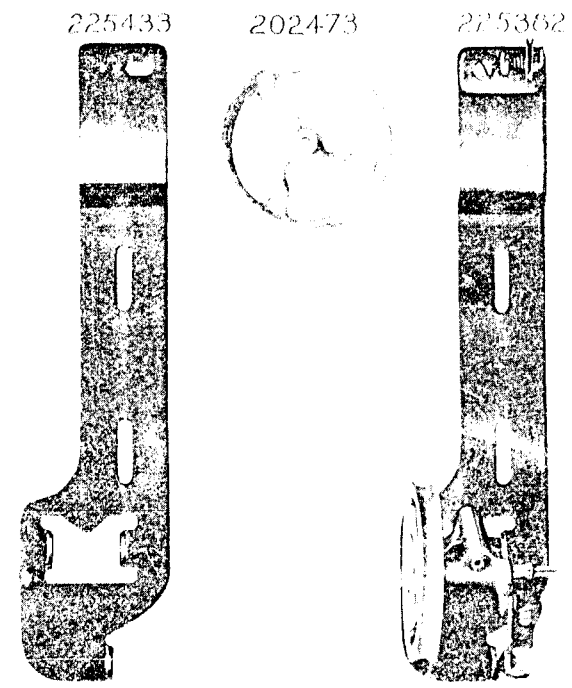

PLATE 12401—FULL SIZE

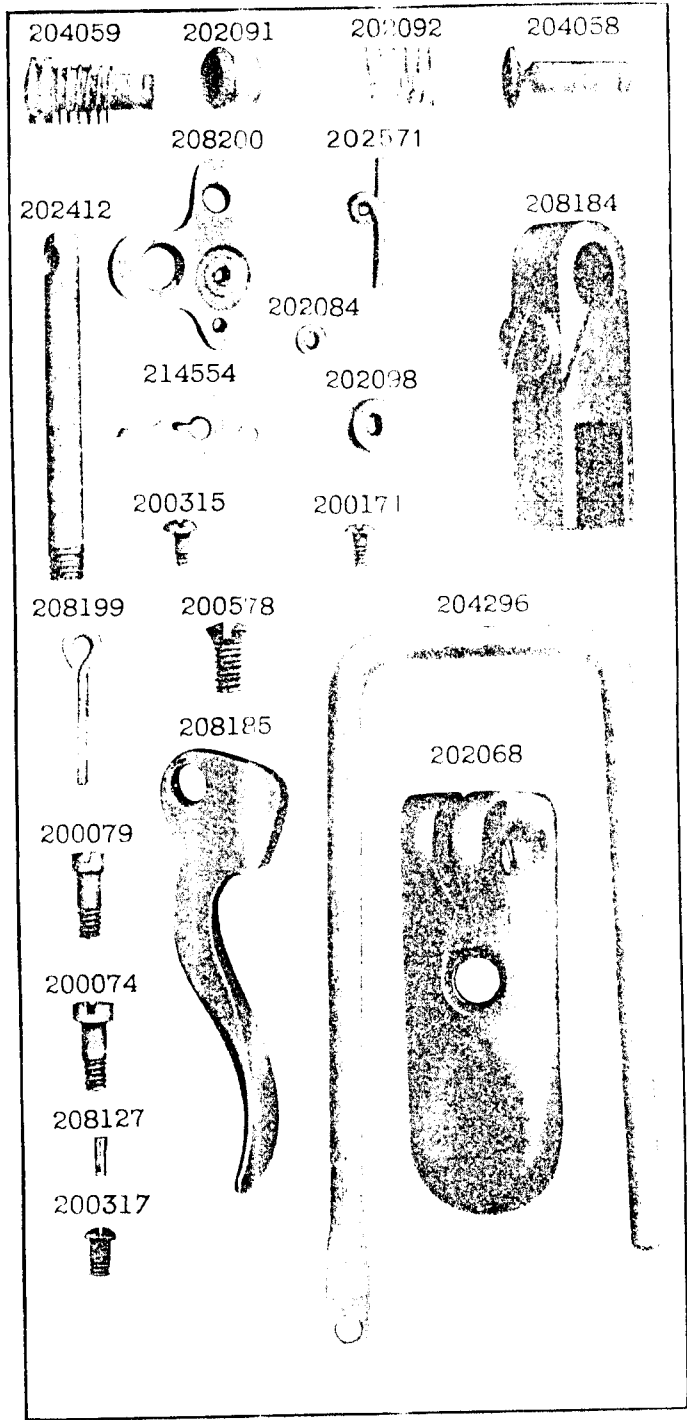

PLATE 12403—FULL SIZE

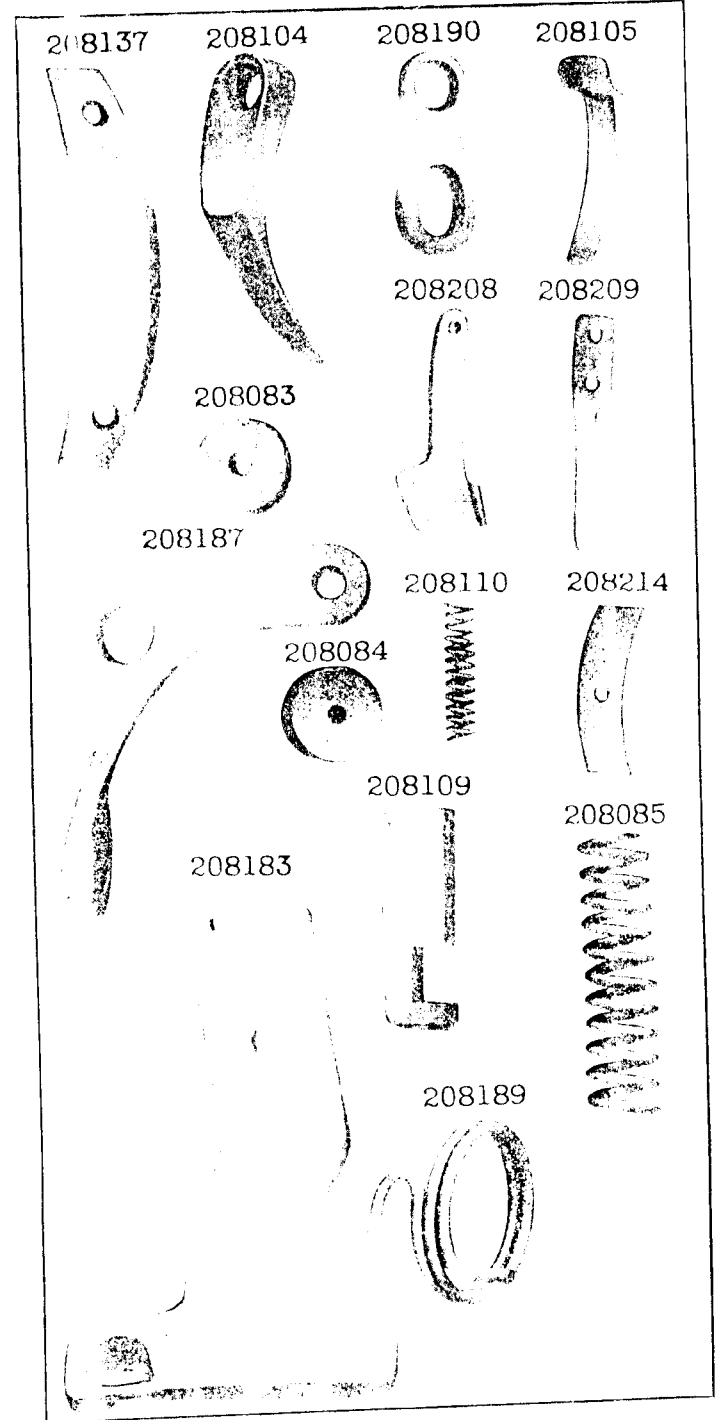

PLATE 12405 FULL SIZE

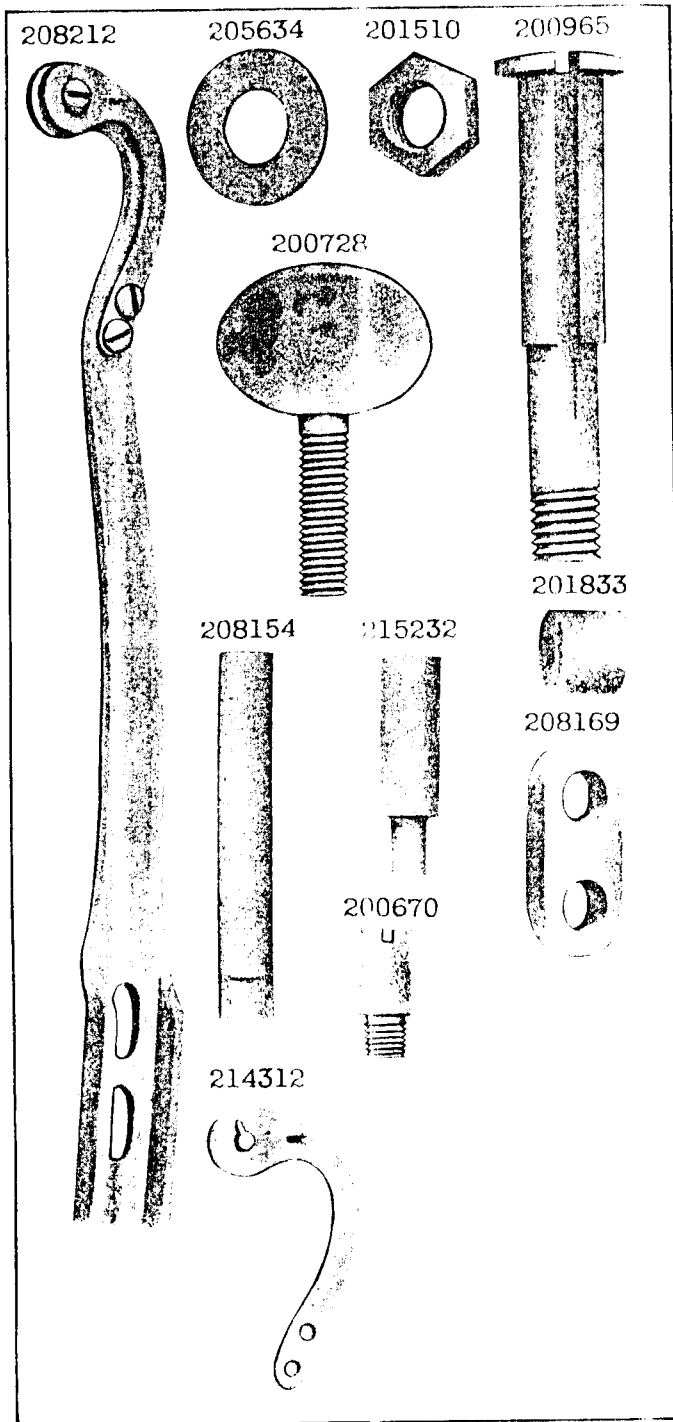

PLATE 12406 FULL SIZE

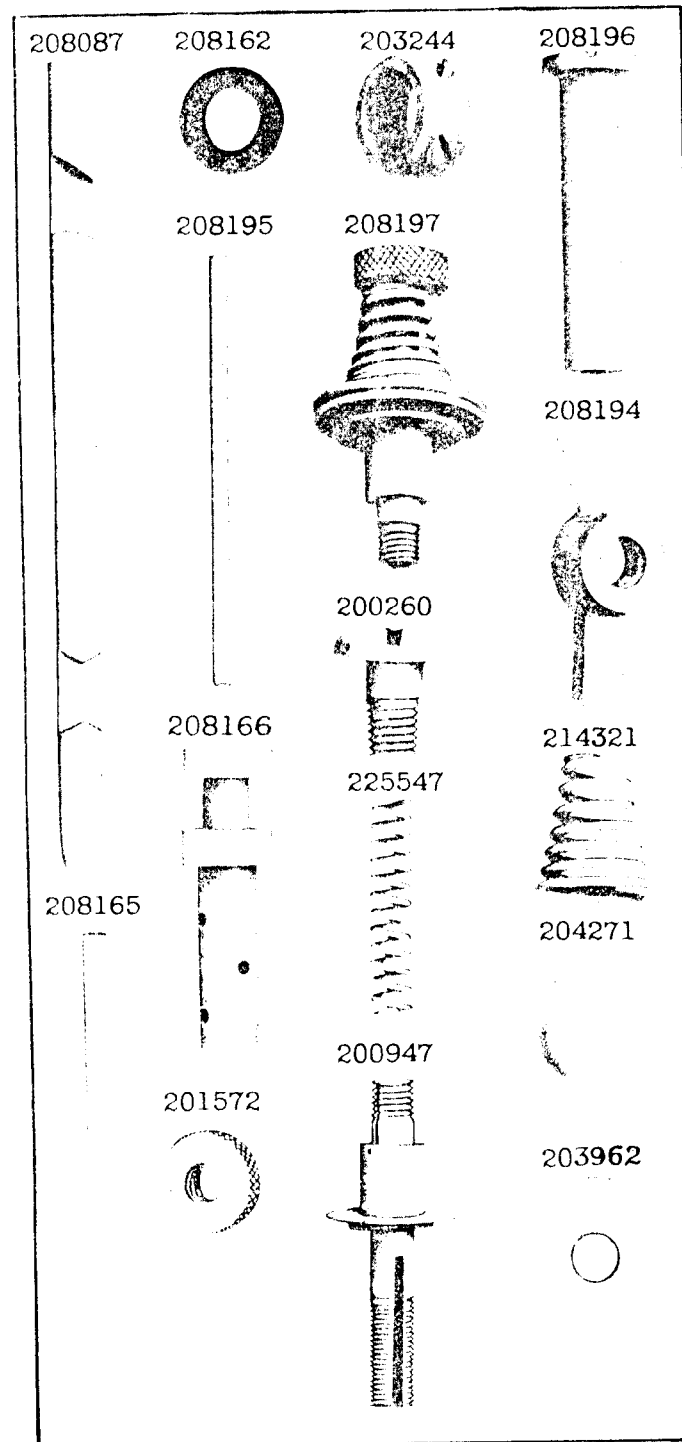

PLATE 12407—FULL SIZE

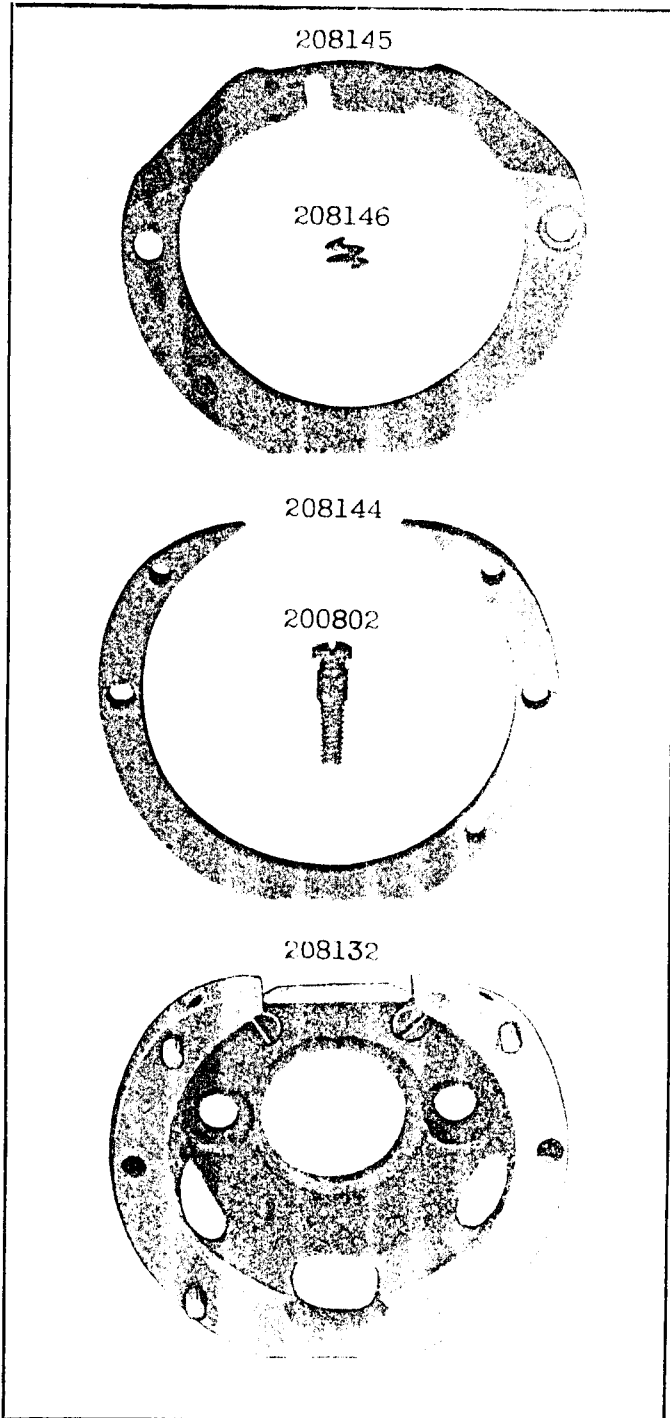

PLATE 12408—FULL SIZE

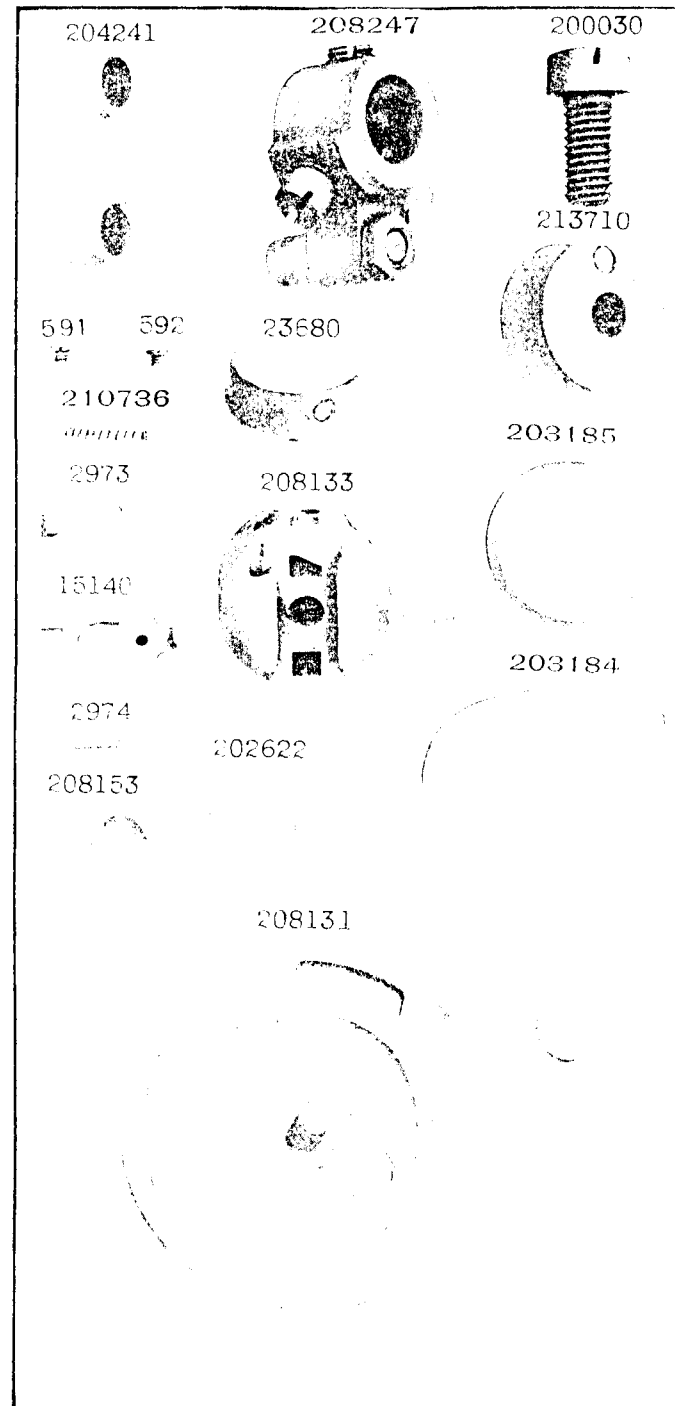

PLATE 12409 FULL SIZE

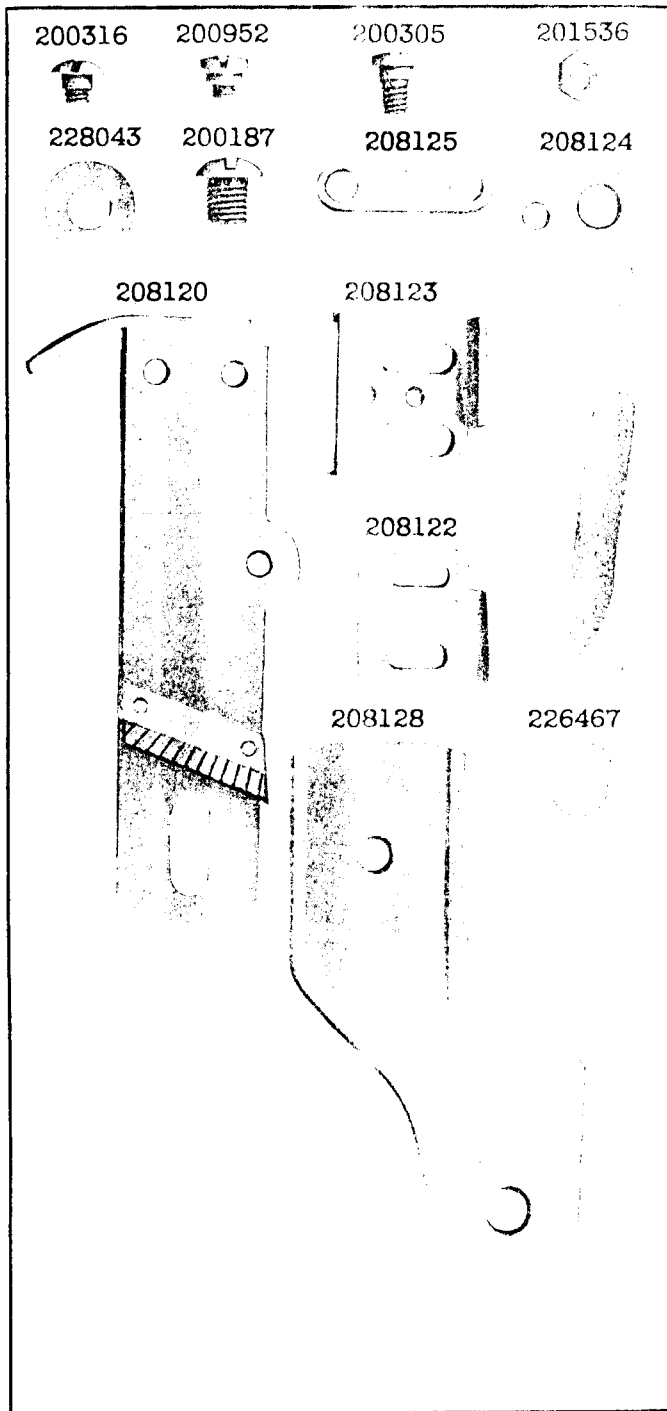

PLATE 12410—FULL SIZE

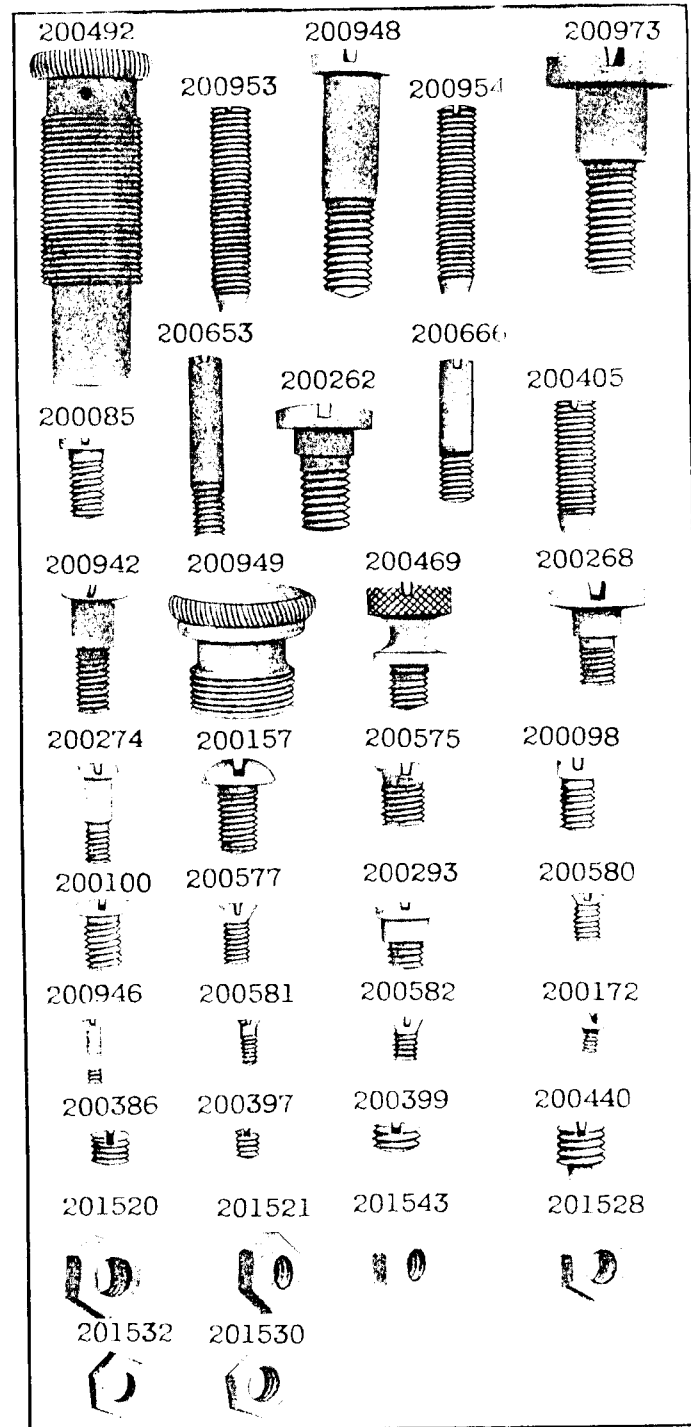

PLATE 12411-FULL SIZE

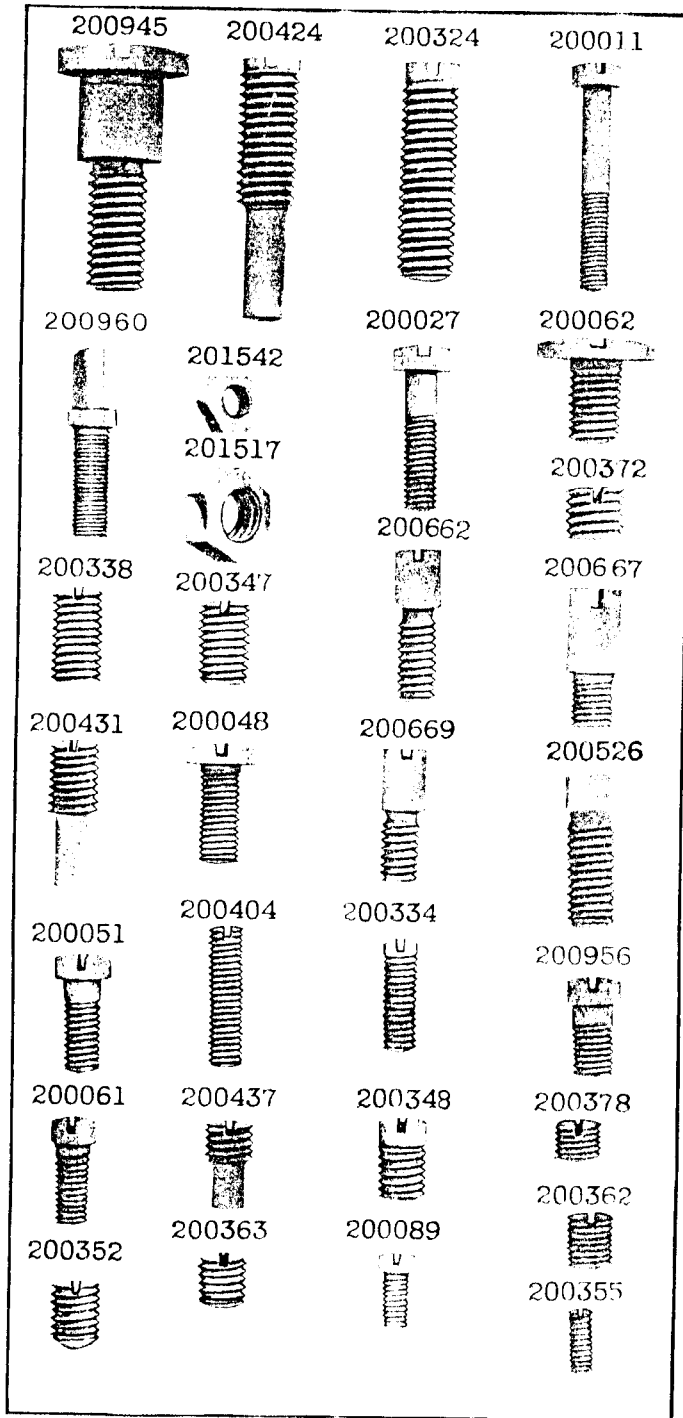

PLATE 12412-FULL SIZE

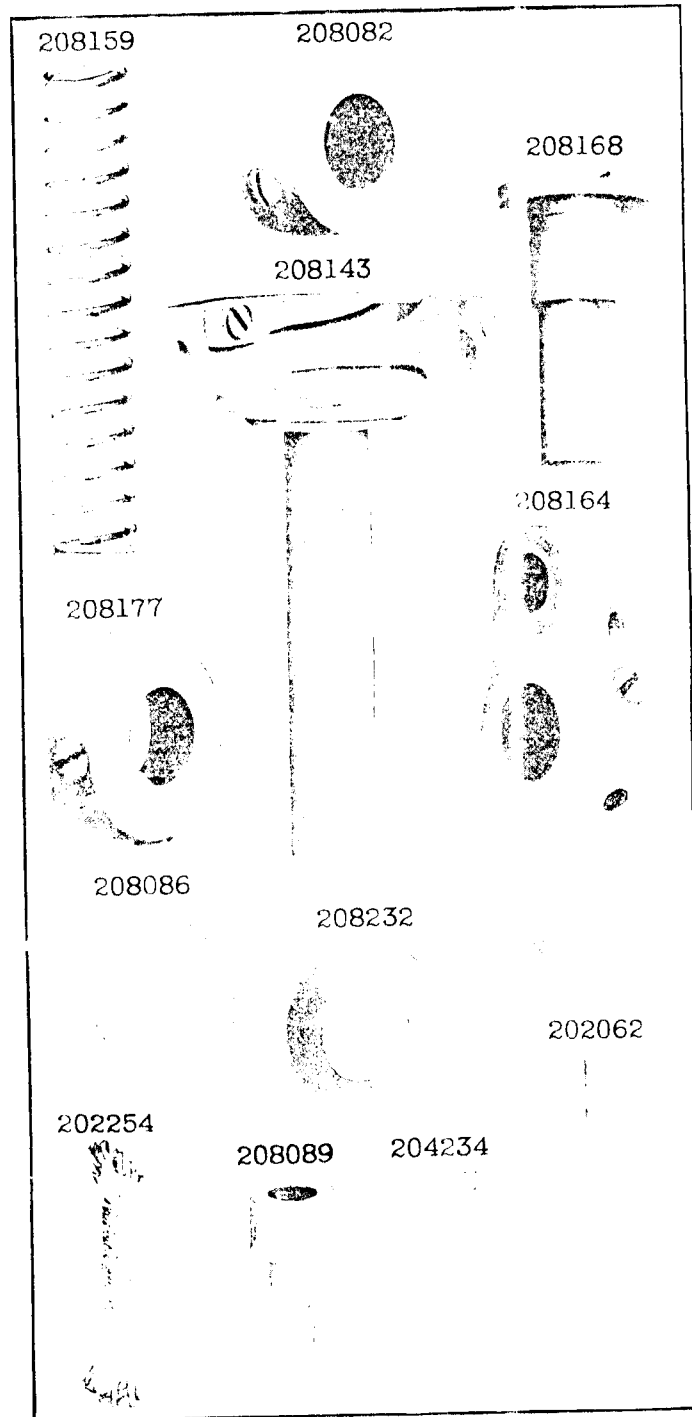

PLATE 12413--FULL SIZE

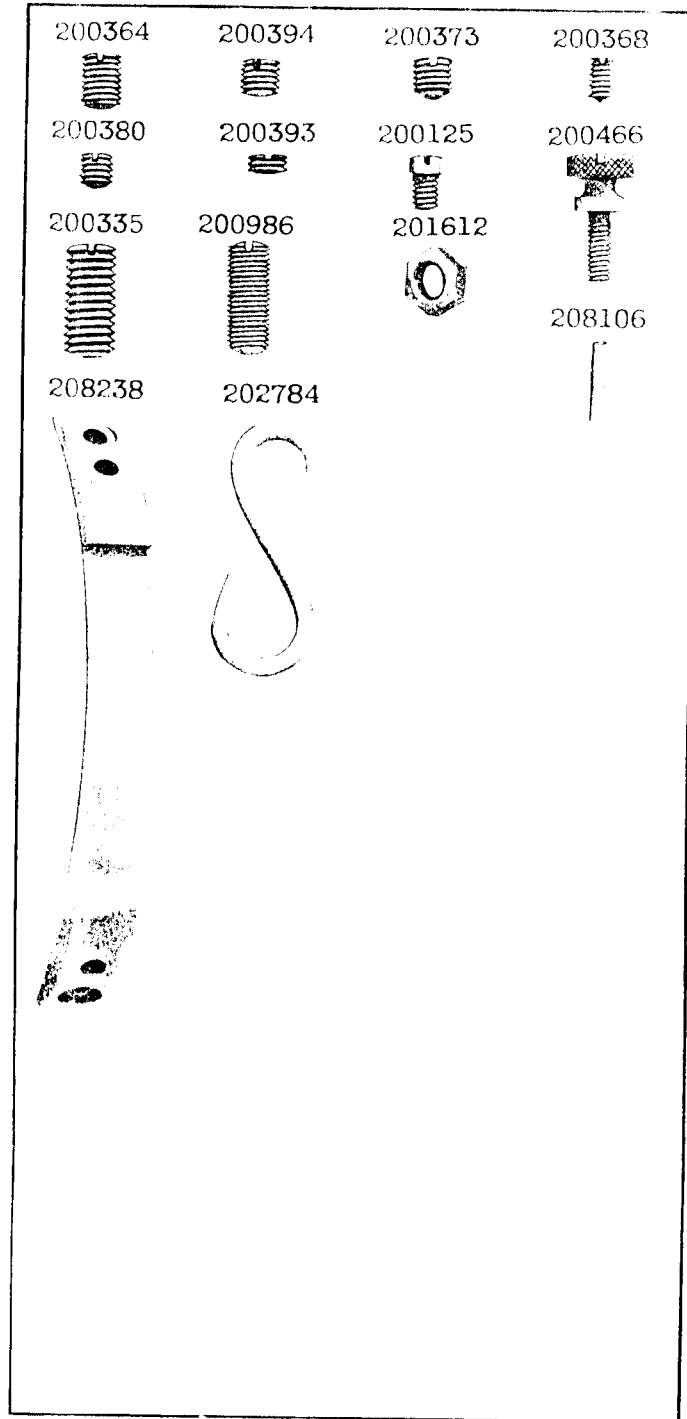

PLATE 12414--FULL SIZE

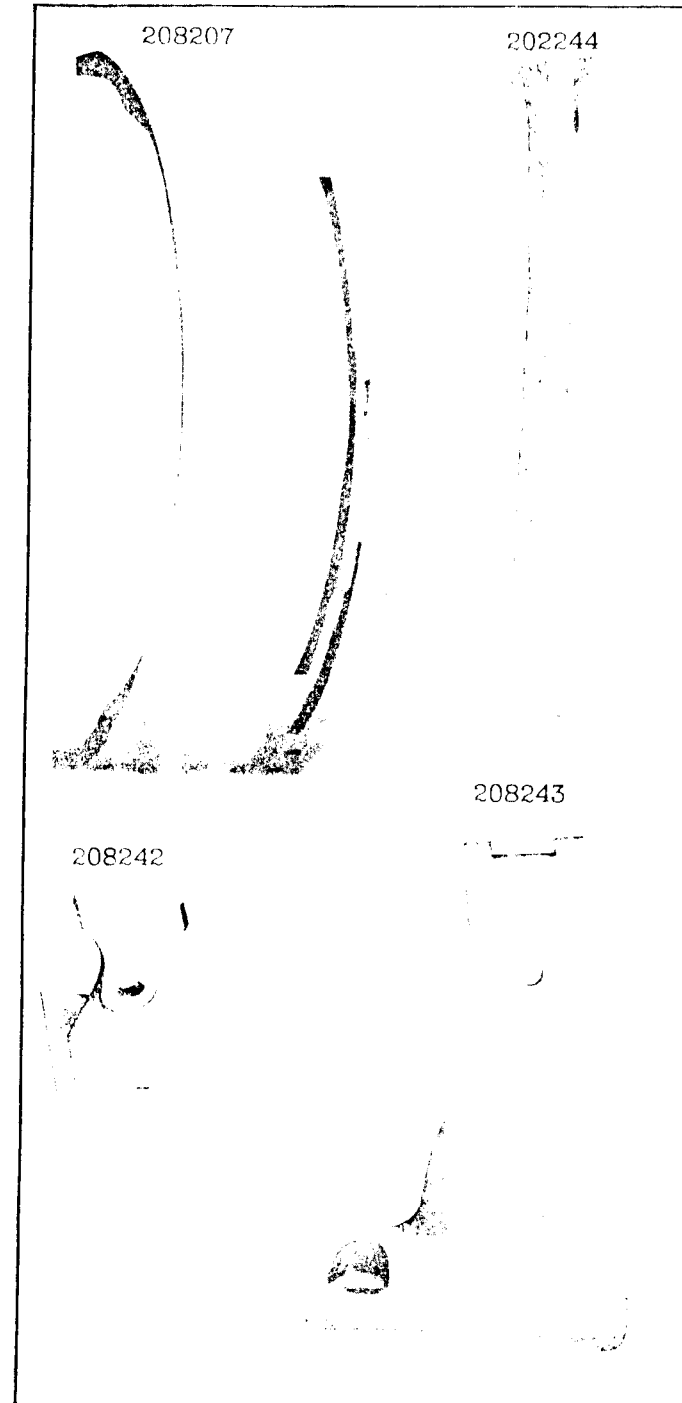

PLATE 12415--ONE-HALF SIZE

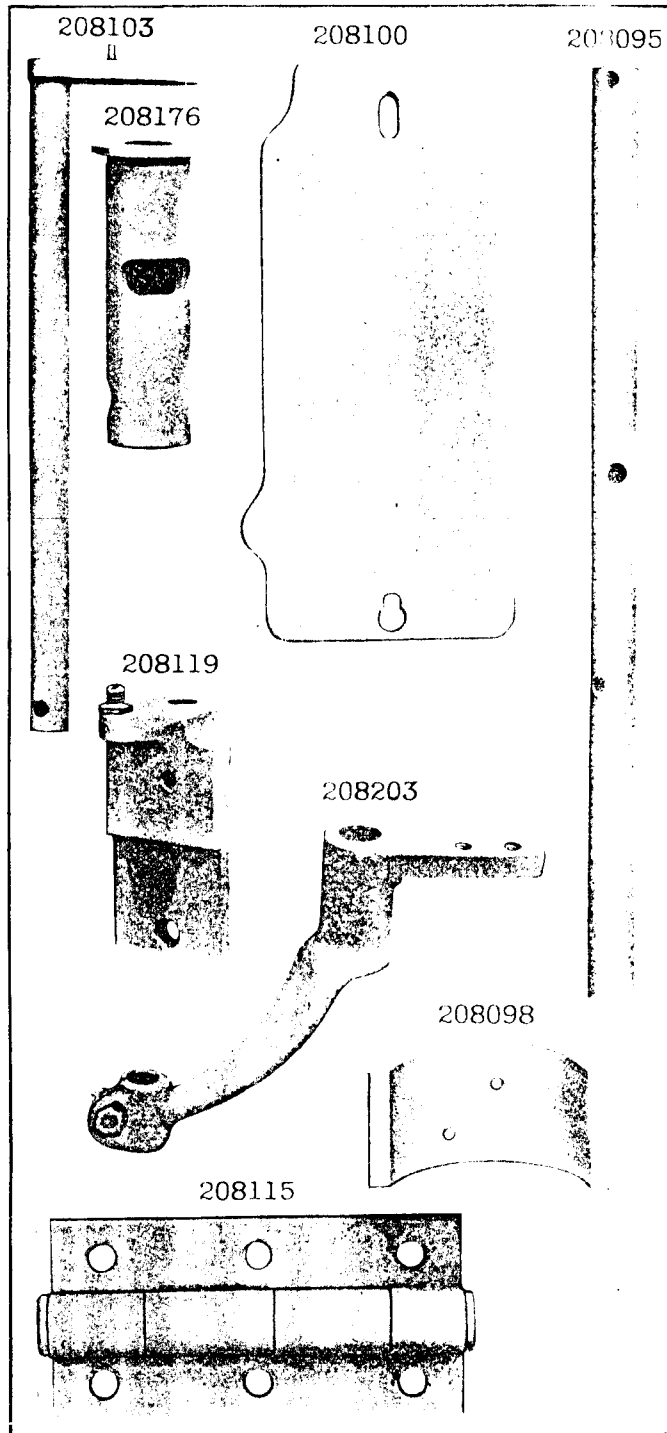

PLATE 12416--ONE-HALF SIZE

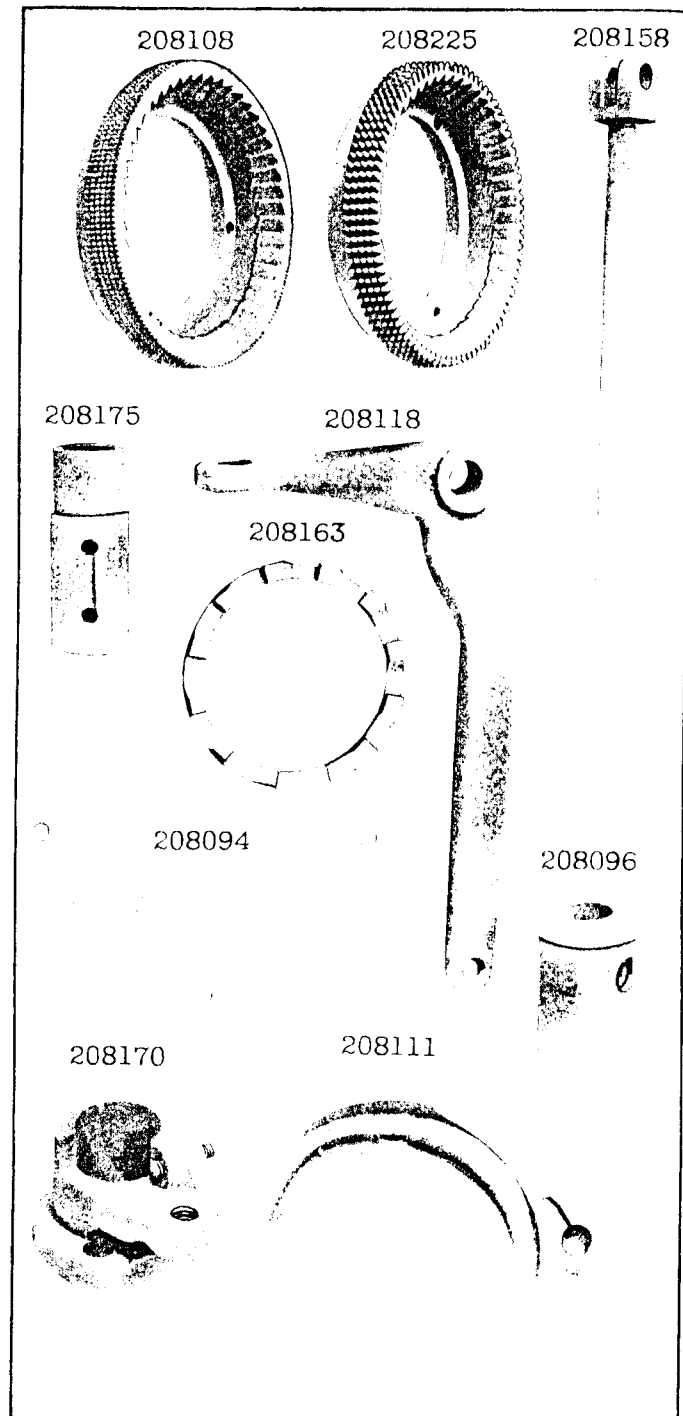



PLATE 12417—ONE-HALF SIZE

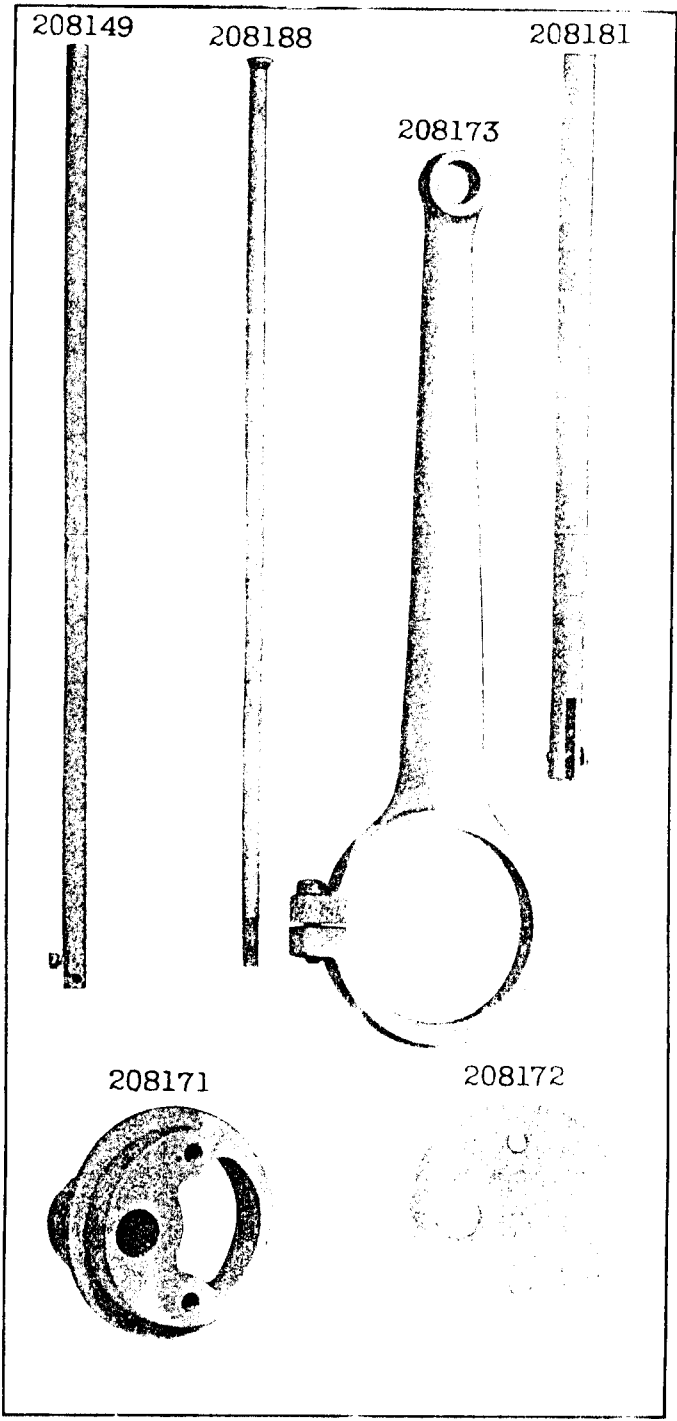

PLATE 12418—ONE-HALF SIZE

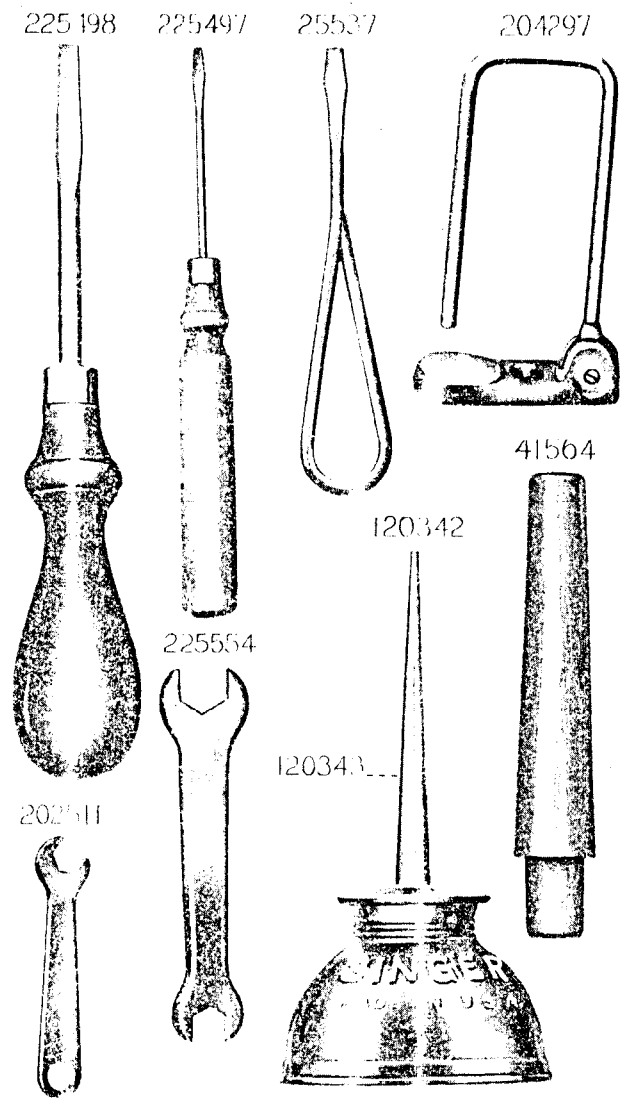

PLATE 12419—ONE-FOURTH SIZE

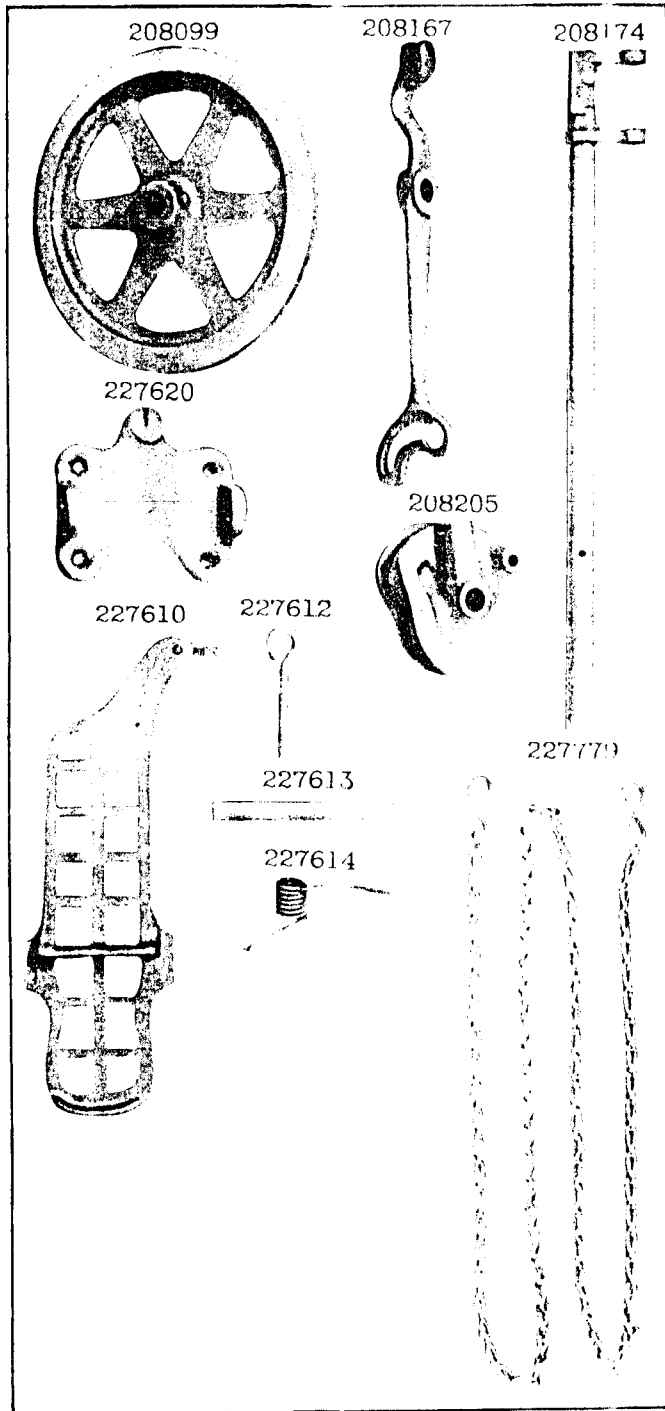

PLATE 12423—FULL SIZE

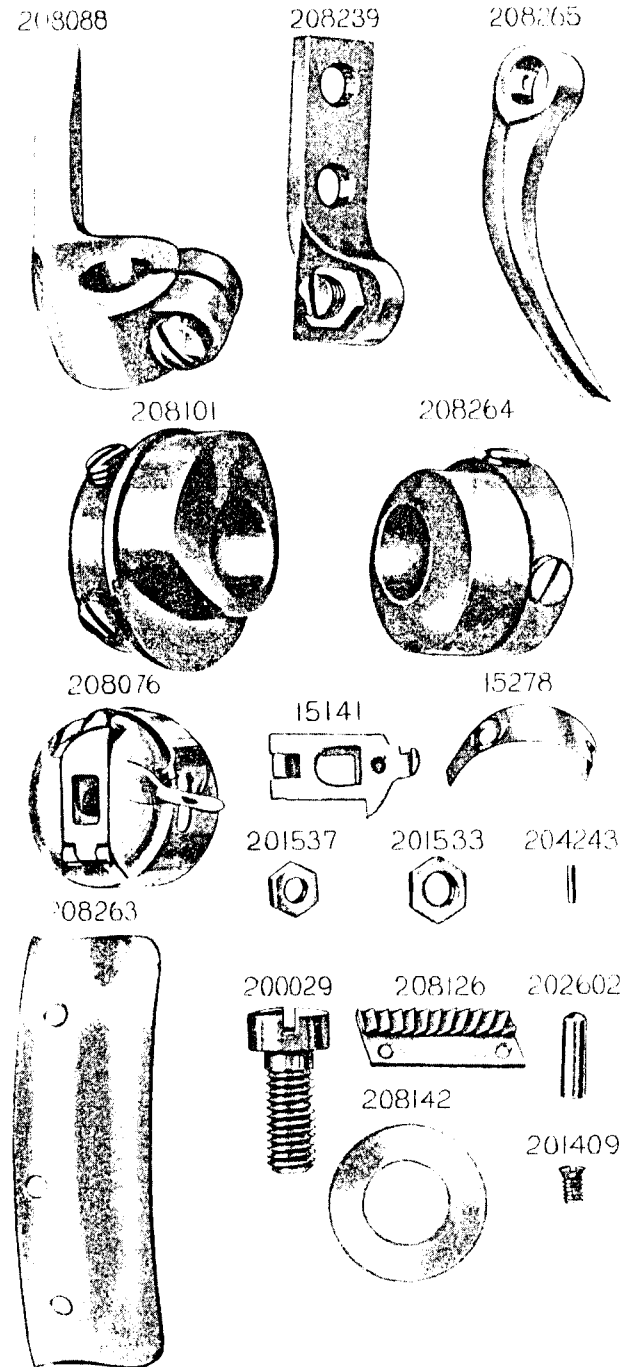

PLATE 12424—ONE-HALF SIZE

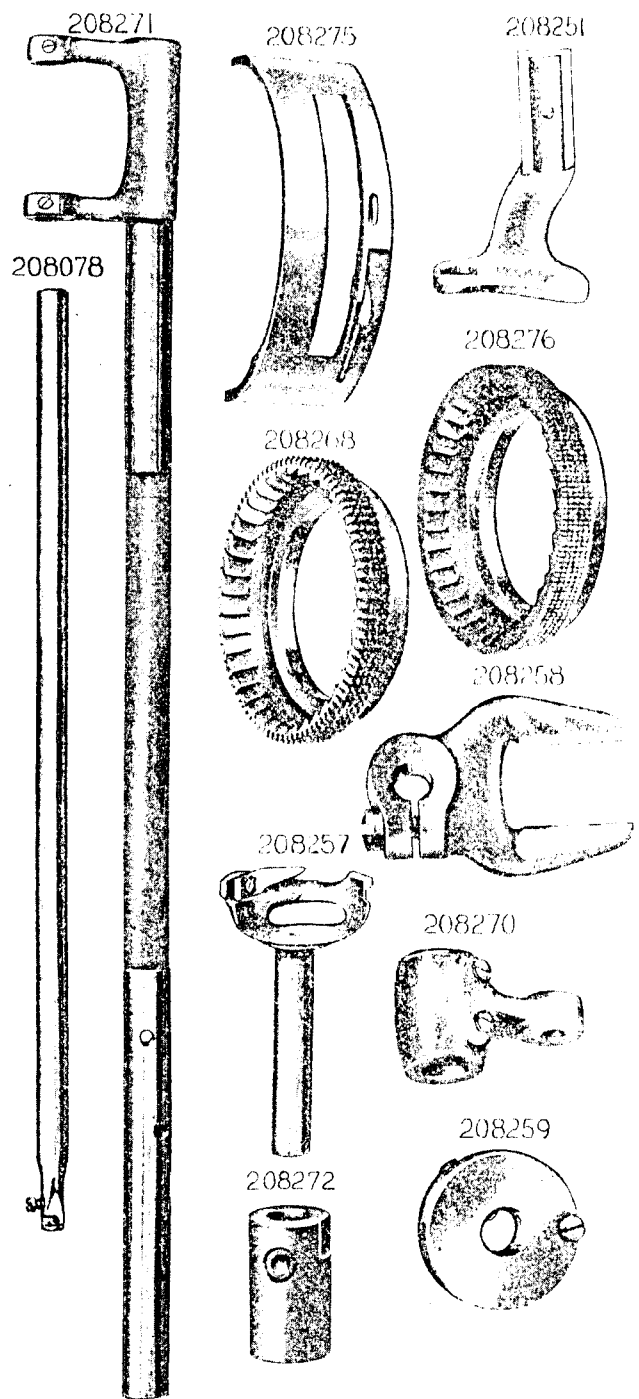

PLATE 12425—FULL SIZE

