

SINGER
110W115,W120

Form 1850 w
October, 1923

PRINTED IN U. S. A.

LIST OF PARTS



MACHINES

Nos. 110w115 and 110w120

THE SINGER MANUFACTURING COMPANY

COPYRIGHT, U. S. A., 1919, 1922 AND 1923,
BY THE SINGER MANUFACTURING CO.
ALL RIGHTS RESERVED FOR ALL COUNTRIES

INDEX

| | PAGE |
|-------------------------------|------|
| ACCESSORIES | 28 |
| BOBBIN WINDER | 28 |
| FEED GEARS | 31 |
| " WHEELS | 32 |
| GUIDES | 32 |
| KNEE LIFTER | 29 |
| MACHINE No. 110w115 | 7 |
| " " 110w120 | 18 |
| NUMERICAL LIST OF PARTS | 35 |
| OBSOLETE PARTS | 34 |
| THROAT PLATES | 33 |

Instructions for Ordering

In ordering from this list, use **ONLY** the **PART** number in the **FIRST** column.

The number stamped on a Sewing Machine Part is the number of the Single Part only, except when the part includes Set Screws, Clamping Screws, Studs and Rollers Spun on, Small Wires riveted, or Parts soldered together, etc., which it is necessary to furnish in combination.

Every combination of parts sent out has its specific number which, although not stamped on Parts (except in above cases) must be used when ordering the combination.

Each number always indicates the **SAME PART** in whatever list it appears, or for whatever Machine.

The letters after some of the numbers indicate the style of finish only, as follows:

- A. Hardened, Polished and Plated.
- B. Polished and Plated.
- C. Hardened only.
- D. Polished only.
- E. Soft, not polished.
- F. Hardened and Polished.
- H. Blued.

These letters **MUST BE USED** when they appear in the list and **AFTER** the number, as in the list.

In this series

- 200001 to 201500 are Screw Numbers.
- 201501 to 201800 are Nut Numbers.
- 201801 to 202000 are Roller Numbers.
- 202001 and upward are numbers of Machine Parts.

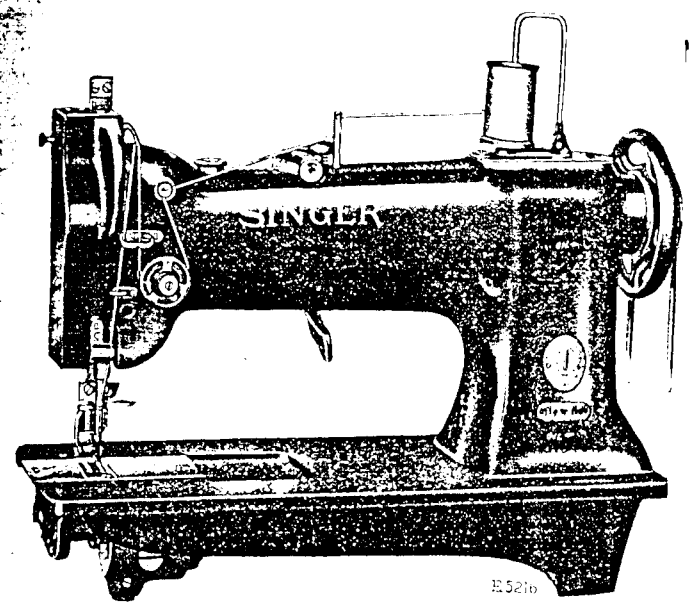
The figures in the second column refer only to the plate in which the illustration of the part is shown and are **NOT TO BE USED** in ordering.

Two or more numbers over a cut indicate that the difference between such parts is not visible in an illustration.

Parts marked with an asterisk (*) are furnished only when repairs are made at the factory.

LIST OF PARTS COMPLETE

FOR



MACHINE No. 110w115

VERTICAL HOOK. ROLLER PRESSER.

CONTINUOUS WHEEL FEED.

VERTICAL TRIMMER

For Leather Work

| No. | Plate | Name |
|---------|-------|---|
| *237801 | — | Arm |
| 203091 | 14186 | " Cap |
| 200273H | 14176 | " " Screw |
| 202248 | 14176 | " " " Washer |
| 203089 | 14186 | " " Spool Holder Base |
| 203090 | 14186 | " " " " " 203089 with 200079H and 204296 |
| 200585H | 14187 | Arm Cap Spool Holder Base Screw |
| 204296 | 14186 | " " " " Wire |
| 200079H | 14187 | " " " " " Hinge Screw |

| No. | Plate | Name |
|---------|-------|--|
| 203092 | — | Arm Cap and Spool Holder complete, Nos. 203090, 203091 and two 200585H |
| 204235 | 14187 | Arm Position Pin (2) |
| 200004E | 14176 | " Screw |
| 200010E | 14176 | " " (2) |
| 202005 | 14176 | " " Washer (3) |
| 202632 | 14186 | " Side Plate |
| 200462B | 14176 | " " Thumb Screw |
| 237802 | 14189 | " Shaft with 200357E and 203100 |
| 237748 | 14186 | " " Bushing (back) with 202299 |
| 202299 | — | Arm Shaft Bushing (back) Oil Packing (wick) |
| 200071E | 14176 | Arm Shaft Bushing (back) Screw (3) |
| 202245 | 14186 | Arm Shaft Bushing (front) with 202036 and 202260 |
| 202260 | — | Arm Shaft Bushing (front) Oil Packing (wick) |
| 200502B | 14176 | Arm Shaft Bushing (front) Oil Packing Thumb Screw |
| 202036 | 14176 | Arm Shaft Bushing (front) Position Pin |
| 200338C | 14176 | Arm Shaft Bushing (front) Set Screw |
| 203100 | — | Arm Shaft Oil Packing (wick) |
| 200357E | 14176 | " " " " Stop Screw |
| 223842 | 14189 | Balance Wheel (belt groove 2 3/4 in. diam.) with 200328c and 200335c |
| 200062H | 14176 | Balance Wheel Adjusting Screw |
| 200328c | 14176 | " " Position Screw |
| 200335c | 14176 | " " Set Screw |
| *237803 | — | Bed |
| 202258 | 12345 | " Hinge Connection (2) |
| 200570E | 14176 | " " " Screw (4) |
| 237901 | 14186 | " Slide (back) |
| 237706 | 14186 | " " (front) |
| 203470 | 14176 | Bobbin |
| *203520 | — | " Case |
| 203648 | 14176 | " " Latch |
| *202056 | — | " " " Pin |
| 203473 | 14176 | " " " Plunger |
| 203474 | 14176 | " " " Spring |
| 236078 | 14176 | " " Lever |
| 203476 | 14176 | " " " Eccentric |
| 204243 | 14176 | " " " " Position Pin |
| 235751 | 14176 | " " " Fulcrum |
| 200056D | 10884 | " " " " Screw |
| 203478 | 14176 | " " " Slide Stud |

| No. | Plate | Name |
|---------|-------|--|
| 203214 | 14176 | Bobbin Case Tension Spring |
| 200984c | 14176 | " " " " Regulating Screw |
| 200594c | 14176 | Bobbin Case Tension Spring Screw |
| 203216 | — | " " Washer (cloth) |
| 203521 | 14176 | Bobbin Case complete, Nos. 200594c, 200984c, 202056, 203214, 203216, 203473, 203474, 203520 and 203648 |
| 237804 | 14186 | Face Plate |
| 202135 | 14176 | " " Position Pin |
| 200473B | 14176 | " " Thumb Screw |
| 237707 | 14190 | Feed Wheel |
| 350085F | 14179 | " " Adjusting Screw |
| 237708 | 14179 | " " " " Block |
| 237709 | 14180 | " " Bracket |
| 237710 | 14179 | " " " Spring |
| 237713 | 14179 | " " Driving Gear with 200382c and 201220c (for 16 stitches) |
| 201220c | 14187 | Feed Wheel Driving Gear Position Screw |
| 200382c | 14179 | Feed Wheel Driving Gear Set Screw |
| 237718 | 14179 | " " " Pinion with 200382c and 201220c (for 16 stitches) |
| 201220c | 14187 | Feed Wheel Driving Pinion Position Screw |
| 200382c | 14179 | Feed Wheel Driving Pinion Set Screw |
| 237721 | 14189 | Feed Wheel Driving Shaft |
| 237722 | 14179 | " " " " Bushing (back) |
| 237723 | 14179 | Feed Wheel Driving Shaft Bushing (front) |
| 200362c | 14179 | Feed Wheel Driving Shaft Bushing Set Screw |
| 221743 | 14179 | Feed Wheel Driving Shaft Collar with two 200380c |
| 200380c | 14179 | Feed Wheel Driving Shaft Collar Set Screw |
| 237724 | 14179 | Feed Wheel Driving Shaft Gear with 200378c and 201220c |
| 201220c | 14187 | Feed Wheel Driving Shaft Gear Position Screw |
| 200378c | 14179 | Feed Wheel Driving Shaft Gear Set Screw |
| 237725 | 14179 | Feed Wheel Stud |
| 201697c | 14179 | " " " Nut |

| No. | Plate | Name |
|---------|-------|--|
| *203482 | — | Hook (sewing) |
| 237726 | 14181 | " 203482 with 201253F, 201376F and 221148 |
| 237727 | — | Hook and Bobbin Case complete, Nos. 203521 and 237726 |
| 235755 | 14181 | Hook Bevel Gear Socket, 18 teeth |
| 235527 | 14181 | " " " " Bushing (lower) (brass) |
| 200362c | 14179 | Hook Bevel Gear Socket Bushing (lower) Set Screw |
| 235756 | 14181 | Hook Bevel Gear Socket Bushing (upper) (brass) |
| 449c | 14181 | Hook Bevel Gear Socket Bushing (upper) Set Screw |
| 200555H | 14181 | Hook Bevel Gear Socket Screw .. |
| 235635 | 14181 | " " " " Thrust Washer |
| 235529 | 14181 | Hook Driving Bevel Gear with two 350089c |
| 350089c | 14181 | Hook Driving Bevel Gear Set Screw |
| 237728 | 14190 | " " Shaft |
| 235857 | 14181 | " " " Bevel Gear with 200374c and 200396c |
| 237729 | 14180 | Hook Driving Shaft Bevel Gear Housing with 200346c and three 200362c |
| 237730 | 14180 | Hook Driving Shaft Bevel Gear Housing Cap (bottom) |
| 237731 | 14180 | Hook Driving Shaft Bevel Gear Housing Cap (bottom) Gasket .. |
| 237732 | 14180 | Hook Driving Shaft Bevel Gear Housing Cap (side) |
| 237733 | 14180 | Hook Driving Shaft Bevel Gear Housing Cap (side) Gasket |
| 200053c | 14181 | Hook Driving Shaft Bevel Gear Housing Cap Screw (4) |
| 201082E | 14181 | Hook Driving Shaft Bevel Gear Housing Screw (long) |
| 225532 | 14187 | Hook Driving Shaft Bevel Gear Housing Screw (long) Washer.. |
| 201308E | 14181 | Hook Driving Shaft Bevel Gear Housing Screw (short) |
| 200396c | 11607 | Hook Driving Shaft Bevel Gear Po- sition Screw |
| 200374c | 14181 | Hook Driving Shaft Bevel Gear Set Screw |
| 237734 | 14181 | Hook Driving Shaft Bushing (back) |
| 200362c | 14179 | " " " " " Set Screw |

| No. | Plate | Name |
|---------|-------|--|
| 235531 | 14181 | Hook Driving Shaft Bushing (front) |
| 200347c | 14181 | " " " " " Set Screw |
| 221743 | 14179 | Hook Driving Shaft Collar with two 200380c |
| 200380c | 14179 | Hook Driving Shaft Collar Set Screw |
| 221148 | 14181 | Hook Gib |
| 201376F | 14181 | " " Hinge Screw |
| 201253F | 14181 | " " Screw |
| 237735 | 14180 | " Saddle with 449c, 200347c and three 200362c |
| 235534 | 14182 | Hook Saddle Oil Cover |
| 201185D | 14182 | " " " " Screw (2) |
| 201318E | 14182 | " " " Stop Screw (2) |
| 235535 | — | " " Oiling Felt |
| 202260 | — | " " Wick |
| 235649 | 14182 | " " " " Cover |
| 200169H | 14182 | " " " " " Screw |
| 201308E | 14181 | " " Screw (2) |
| 213018 | — | " Washer |
| 203507 | 14182 | " " 213018 with 203476 and two 204243 |
| 208490 | 14190 | Knee Lifter Connection Lever |
| 200262H | 14182 | " " " " Hinge Screw |
| 237766 | 14190 | Knee Lifter Connection Lever Lift- ing Rod with 202302 |
| 202302 | 14182 | Knee Lifter Connection Lever Lift- ing Rod Cotter Pin |
| 237805 | 14189 | Knee Lifter Lifting Lever |
| 200262H | 14182 | " " " " Hinge Screw |
| 207805 | 14187 | Knife |
| 200397H | 11610 | " Adjusting Screw |
| 237806 | 14190 | " Bar |
| 237807 | 14187 | " " Angle Extension |
| 200126E | 14187 | " " " " Screw (2) |
| 221417 | 14190 | " " Driving Eccentric with 200382c and 200437c |
| 202890 | 14190 | Knife Bar Driving Eccentric Fork with 200382c and 201464c |
| 201464c | 14187 | Knife Bar Driving Eccentric Fork Position Screw |
| 200382c | 14179 | Knife Bar Driving Eccentric Fork Set Screw |
| 200437c | 14187 | Knife Bar Driving Eccentric Posi- tion Screw |
| 200382c | 14179 | Knife Bar Driving Eccentric Set Screw |

| No. | Plate | Name |
|---------|-------|--|
| 202891 | 14192 | Knife Bar Driving Shaft Crank with 200694F and 201525E |
| 203244 | 14187 | Knife Bar Driving Shaft Crank Collar with two 200393c |
| 200393c | 14187 | Knife Bar Driving Shaft Crank Collar Set Screw |
| 200694F | 14187 | Knife Bar Driving Shaft Crank Screw Stud |
| 201525E | 14187 | Knife Bar Driving Shaft Crank Screw Stud Nut |
| 237808 | 14187 | Knife Bar Guide Block |
| 200011E | 14187 | " " " " Screw (2) .. |
| 200337c | 14187 | " " " " Screw |
| 201531E | 14187 | " " " " Nut |
| 237829 | 14187 | " " Lifting Spring |
| 202346 | 14187 | " " " " Plunger .. |
| 237809 | 14191 | " " Position Bracket |
| 201387F | — | " " " " Screw (2) |
| 237810 | 14191 | " Holder with 200397H |
| 200898D | 14191 | " " Screw |
| 237811 | 14191 | " " Switch-in Handle |
| 200076D | 14191 | " Screw (2) |
| 237812 | 14192 | " Switch-out Handle with two 200373c |
| 200373c | 14191 | Knife Switch-out Handle Set Screw |
| 202899 | 14192 | " " " Shaft |
| 202900 | 14191 | " " " Spring (spiral) |
| 237822 | 14192 | Needle Bar with 200389c |
| 202552 | 11607 | " " Connecting Link |
| 223687 | — | " " " " Oil Guard |
| 200161D | 11607 | Needle Bar Connecting Link Oil Guard Screw |
| 202333 | 11607 | Needle Bar Connecting Link Stud with 202254 |
| 202254 | — | Needle Bar Connecting Link Stud Oil Packing (wick) |
| 200374c | 11181 | Needle Bar Connecting Link Stud Set Screw |
| 200383c | 14182 | Needle Bar Connecting Link Stud Set Screw |
| *206891 | — | Needle Bar Connecting Stud |
| 202329 | 11607 | " " " " 206891 with 200086c and 202330 |
| 202330 | — | Needle Bar Connecting Stud Oil Packing (wick) |
| 200086c | 11607 | Needle Bar Connecting Stud Pinch Screw |

| No. | Plate | Name |
|---------|-------|---|
| 202692 | 14192 | Needle Bar Crank with 200335c, 200374c, 200383c, 200428c and 202333 |
| 237737 | — | Needle Bar Crank 202692 with 202329, 202399, 202400, 202552 and 237762 |
| 203172 | 11607 | Needle Bar Crank Friction Washer |
| 200428c | 11607 | " " " Position Screw.. |
| 200335c | 14176 | " " " Set Screw |
| 237813 | 14192 | " " Rock Frame |
| 237814 | — | " " " 237813 with 237822 |
| *38127 | — | Needle Bar Rock Frame Driving Eccentric |
| *237749 | — | Needle Bar Rock Frame Driving Eccentric Body |
| 350107c | 14191 | Needle Bar Rock Frame Driving Eccentric Body Position Screw.. |
| 443c | 14182 | Needle Bar Rock Frame Driving Eccentric Body Set Screw |
| 21331 | 14182 | Needle Bar Rock Frame Driving Eccentric Pressure Spring |
| 21332 | 14182 | Needle Bar Rock Frame Driving Eccentric Pressure Spring Cap.. |
| 934D | 14182 | Needle Bar Rock Frame Driving Eccentric Pressure Spring Cap Screw |
| 1103c | 14182 | Needle Bar Rock Frame Driving Eccentric Regulating Screw |
| 217D | 14191 | Needle Bar Rock Frame Driving Eccentric Set Screw |
| 7071 | 14191 | Needle Bar Rock Frame Driving Eccentric Set Screw Washer ... |
| 237750 | — | Needle Bar Rock Frame Driving Eccentric complete, Nos. 217D, 443c, 934D, 1103c, 7071, 21331, 21332, 38127, 237749 and 350107c |
| 237739 | 14192 | Needle Bar Rock Frame Driving Fork Lever with 200029E |
| 200029E | 14182 | Needle Bar Rock Frame Driving Fork Lever Pinch Screw |
| 237740 | 14182 | Needle Bar Rock Frame Driving Fork Lever Slide Block (two pieces) |
| 210910 | 11607 | Needle Bar Rock Frame Hinge Stud with 202277 |
| 202277 | — | Needle Bar Rock Frame Hinge Stud Oil Packing (wick) |
| 200347c | 14181 | Needle Bar Rock Frame Hinge Stud Set Screw |

| No. | Plate | Name |
|---------|-------|--|
| 202667 | 14192 | Needle Bar Rock Frame Rock Shaft |
| 210978 | — | “ “ “ “ “ “ |
| | | 202667 with 200386c and 210920.. |
| 237815 | 14191 | Needle Bar Rock Frame Position Bracket with 200337c and 201531E |
| 350129E | 14191 | Needle Bar Rock Frame Position Bracket Screw (2) |
| 202668 | 11607 | Needle Bar Rock Frame Slide Block |
| 210920 | — | “ “ “ “ “ “ |
| | | 202668 with 201141c |
| 201141c | 14182 | Needle Bar Rock Frame Slide Block Screw Stud |
| 200386c | 11607 | Needle Bar Rock Frame Slide Block Screw Stud Set Screw |
| 200389c | 11610 | Needle Set Screw |
| 207072 | 11607 | Presser Bar Bushing (2) |
| 200352c | 14182 | “ “ “ Set Screw (2) |
| 202671 | 14182 | “ “ Lifter |
| 200653c | 14182 | “ “ “ Hinge Screw .. |
| 202672 | 14191 | “ “ Lifting Releasing Lever Bracket |
| 200975F | 14191 | Presser Bar Lifting Releasing Lever Bracket Guide Screw |
| 237765 | 14191 | Presser Bar Lifting Releasing Lever Bracket Spring (spiral) |
| 237820 | 14191 | Presser Bar Position Guide |
| 202338 | 14191 | “ “ “ “ Lever with 200086F |
| 200086F | 11607 | Presser Bar Position Guide Lever Pinch Screw |
| 200352c | 14182 | Presser Bar Position Guide Set Screw |
| 237821 | 14189 | Presser Bar Spring (flat) |
| 210949 | 14193 | Presser Bar Spring Bracket with 200086c |
| 200086c | 11607 | Presser Bar Spring Bracket Pinch Screw |
| 200538c | 14193 | Presser Bar Spring Regulating Screw |
| 200948F | 14193 | Presser Bar Spring Support Screw |
| 201954 | — | Roller Presser, $\frac{3}{8}$ in. diam., $\frac{1}{8}$ in. face |
| 201955 | 14193 | Roller Presser 201954 with 1528J, 201699J, 350104c and twenty-eight 206417 |
| 203422 | 14193 | Roller Presser Arm |
| 237816 | — | “ “ “ 203422 with 201955 |
| 237817 | — | Roller Presser Arm Bracket 202560 with 200096D and 237816 |

| No. | Plate | Name |
|---------|-------|---|
| 200675c | 14193 | Roller Presser Arm Bracket Position Screw Stud |
| 202558 | 14193 | Roller Presser Arm Bracket Spring |
| 202559 | 14193 | “ “ “ “ “ “ |
| | | Stop |
| 200141F | 11607 | Roller Presser Arm Bracket Spring Stop Screw |
| 202560 | 14193 | Roller Presser Arm Bracket (swing) |
| 200096D | 14193 | Roller Presser Arm Screw |
| 206417 | 14193 | “ “ Ball, $\frac{1}{8}$ in. diameter.. |
| 201699c | 14193 | “ “ “ Cone |
| 202557 | 14192 | “ “ Bar |
| 350104c | 14193 | “ “ Hinge Screw |
| 1528J | 14193 | “ “ “ “ Nut |
| 237818 | — | Roller Presser and Bar complete, Nos. 200675c, 202557 to 202559, 237817 and two 200141F |
| 237762 | 14193 | Take-up Lever |
| 202399 | 14193 | “ “ Driving Stud with 202277 |
| 202277 | — | Take-up Lever Driving Stud Oil Packing (wick) |
| 202400 | 14193 | Take-up Lever Hinge Stud with 202423 |
| 202423 | — | Take-up Lever Hinge Stud Oil Packing (wick) |
| 200363c | 14193 | Take-up Lever Hinge Stud Set Screw |
| 202401 | — | Take-up Lever Oiling Felt |
| 200132E | 14193 | “ “ “ “ Screw .. |
| 202402 | 11610 | “ Disc (back) |
| 210967 | 11610 | “ “ (front) |
| 210950 | 14193 | Tension Release Driving Lever with 200394c and 202676 |
| 202676 | 14193 | Tension Release Driving Lever Pin |
| 237819 | 14193 | “ “ “ “ “ “ |
| | | Slide Bar |
| 237828 | — | Tension Release Driving Lever Pin Slide Bar 237819 with 200167E and 210952 |
| 202678 | 14193 | Tension Release Driving Lever Pin Slide Bar Spring |
| 200394c | 14194 | Tension Release Driving Lever Set Screw |
| 210951 | 14194 | Tension Release Washer |
| 202407 | 10881 | “ Spring |
| 200625F | 11610 | “ Stud with 204925 |
| 200061c | 14194 | “ Stud Set Screw |

| No. | Plate | Name |
|---------|-------|---|
| 204925 | 11610 | Tension Stud Washer |
| 201572B | 10881 | " " Thumb Nut |
| 210953 | 11610 | Tension complete, Nos. 200625F, 201572B, 202402, 202407, 202682, 210951 and 210967 |
| 202682 | 11610 | Thread Controller Spring |
| 210952 | 11610 | " " " Stop |
| 200167E | 11610 | " " " " Screw |
| 202412 | 14194 | " Guide |
| 210954 | 11610 | " " (lower) |
| 210955 | 11610 | " " (upper) |
| 200582H | 11610 | " " Screw (3) |
| 210956 | 11610 | " Retainer Bracket with 200397H |
| 200582H | 11610 | " " " Screw (2) .. |
| 202091 | 14194 | " " Sleeve |
| 210993 | 11610 | " " " |
| 202092 | 14194 | " " Spring |
| 223844 | 14194 | " " " |
| 204058 | 14194 | " " Stud |
| 210957 | 11610 | " " " |
| 210958 | 11610 | " " " Collar |
| 200366H | 14194 | " " " Set Screw |
| 200397H | 11610 | " " " " " |
| 210959 | 11610 | Thread Retainer (lower) complete, Nos. 210956 to 210958, 210993 and 223844 |
| 204059 | — | Thread Retainer (upper) complete, Nos. 202091, 202092 and 204058 .. |
| 237823 | 14194 | Throat Plate, 53 elongated needle hole, for needle sizes 14 and 15, with 200178D, 200587D, 211416 and 211424, trims opposite the needle and .045, .060 and .085 in. to right of seam |
| 211424 | 14194 | Throat Plate Knife Follower |
| 200587D | 14194 | " " " " Screw .. |
| 211416 | 14194 | " " " " Spring |
| 200178D | 14194 | " " " " " |
| 691F | 14194 | Throat Plate Screw (2) |
| 237744 | 14192 | Vertical Shaft |
| 237745 | 14194 | " " Bevel Gear (lower) |
| 205508 | 14194 | " " " " " |
| 235857 | 14181 | Position Pin |
| 200396c | 11607 | Vertical Shaft Bevel Gear (upper) with 200374c and 200396c |
| 200374c | 14181 | Vertical Shaft Bevel Gear (upper) Position Screw |
| | | Set Screw |

| No. | Plate | Name |
|---------|-------|---|
| 237734 | 14181 | Vertical Shaft Bushing (lower) .. |
| 200346c | 14194 | " " " " Set Screw |
| 237746 | 14192 | Vertical Shaft Bushing (upper) .. |
| 200362c | 14179 | " " " " Set Screw |
| 237747 | 14194 | Vertical Shaft Driving Gear with 200374c and 200396c |
| 200396c | 11607 | Vertical Shaft Driving Gear Posi- tion Screw |
| 200374c | 14181 | Vertical Shaft Driving Gear Set Screw |
| 237754 | 14194 | Vertical Shaft Oil Leader (lower) (brass) |
| 237755 | 14194 | Vertical Shaft Oil Leader (upper) (brass) |

LIST OF PARTS COMPLETE
FOR
MACHINE No. 110w120

VERTICAL HOOK. ROLLER PRESSER.

CONTINUOUS WHEEL FEED.

UNDEREDGE TRIMMER

For Leather Work

| No. | Plate | Name |
|---------|-------|--|
| *237801 | — | Arm |
| 203091 | 14186 | " Cap |
| 200278H | 14176 | " " Screw |
| 202248 | 14176 | " " Washer |
| 203089 | 14186 | " " Spool Holder Base |
| 203090 | 14186 | " " " " " 203089 with 200079H and 204296 |
| 200585H | 14187 | Arm Cap Spool Holder Base Screw |
| 204296 | 14186 | " " " " Wire |
| 200079H | 14187 | " " " " " Hinge Screw |
| 203092 | — | Arm Cap and Spool Holder complete, Nos. 203090, 203091 and two 200585H |
| 204235 | 14187 | Arm Position Pin (2) |
| 200004E | 14176 | " Screw |
| 200010E | 14176 | " " (2) |
| 202005 | 14176 | " " Washer (3) |
| 202632 | 14186 | " Side Plate |
| 200462B | 14176 | " " Thumb Screw |
| 237802 | 14189 | " Shaft with 200357E and 203100 |
| 237748 | 14186 | " " Bushing (back) with 202299 |
| 202299 | — | Arm Shaft Bushing (back) Oil Packing (wick) |
| 200071E | 14176 | Arm Shaft Bushing (back) Screw (3) |
| 202245 | 14186 | Arm Shaft Bushing (front) with 202036 and 202260 |
| 202260 | — | Arm Shaft Bushing (front) Oil Packing (wick) |
| 200502B | 14176 | Arm Shaft Bushing (front) Oil Packing Thumb Screw |

| No. | Plate | Name |
|---------|-------|---|
| 202036 | 14176 | Arm Shaft Bushing (front) Position Pin |
| 200338c | 14176 | Arm Shaft Bushing (front) Set Screw |
| 203100 | — | Arm Shaft Oil Packing (wick) |
| 200357E | 14176 | " " " " Stop Screw |
| 223842 | 14189 | Balance Wheel (belt groove 2 3/8 in. diam.) with 200328c and 200335c |
| 200062H | 14176 | Balance Wheel Adjusting Screw |
| 200328c | 14176 | " " Position Screw |
| 200335c | 14176 | " " Set Screw |
| *237803 | — | Bed |
| 202258 | 12345 | " Hinge Connection (2) |
| 200570E | 14176 | " " " Screw (4) |
| 237901 | 14186 | " Slide (back) |
| 237706 | 14186 | " " (front) |
| 203470 | 14176 | Bobbin |
| *203520 | — | " Case |
| 203648 | 14176 | " " Latch |
| *202056 | — | " " " Pin |
| 203473 | 14176 | " " " Plunger |
| 203474 | 14176 | " " " Spring |
| 236078 | 14176 | " " Lever |
| 203476 | 14176 | " " " Eccentric |
| 204243 | 14176 | " " " " Position Pin |
| 235751 | 14176 | " " " Fulcrum |
| 200056D | 10884 | " " " " Screw |
| 203478 | 14176 | " " " Slide Stud |
| 203214 | 14176 | " " Tension Spring |
| 200984c | 14176 | " " " " Regulat- ing Screw |
| 200594c | 14176 | Bobbin Case Tension Spring Screw |
| 203216 | — | " " Washer (cloth) |
| 203521 | 14176 | Bobbin Case complete, Nos. 200594c, 200984c, 202056, 203214, 203216, 203473, 203474, 203520 and 203648 |
| 237804 | 14186 | Face Plate |
| 202135 | 14176 | " " Position Pin |
| 200473B | 14176 | " " Thumb Screw |
| 237707 | 14190 | Feed Wheel |
| 350085F | 14179 | " " Adjusting Screw |
| 237708 | 14179 | " " " " Block |
| 237709 | 14180 | " " Bracket |
| 237710 | 14179 | " " " Spring |
| 237713 | 14179 | " " Driving Gear with 200382c and 201220c (for 16 stitches) |
| 201220c | 14187 | Feed Wheel Driving Gear Position Screw |

| No. | Plate | Name |
|---------|-------|---|
| 200382c | 14179 | Feed Wheel Driving Gear Set Screw |
| 237718 | 14179 | " " " Pinion with 200382c and 201220c (for 16 stitches) |
| 201220c | 14187 | Feed Wheel Driving Pinion Position Screw |
| 200382c | 14179 | Feed Wheel Driving Pinion Set Screw |
| 237721 | 14189 | Feed Wheel Driving Shaft |
| 237722 | 14179 | " " " " Bushing (back) |
| 237723 | 14179 | Feed Wheel Driving Shaft Bushing (front) |
| 200362c | 14179 | Feed Wheel Driving Shaft Bushing Set Screw |
| 221743 | 14179 | Feed Wheel Driving Shaft Collar with two 200380c |
| 200380c | 14179 | Feed Wheel Driving Shaft Collar Set Screw |
| 237724 | 14179 | Feed Wheel Driving Shaft Gear with 200378c and 201220c |
| 201220c | 14187 | Feed Wheel Driving Shaft Gear Position Screw |
| 200378c | 14179 | Feed Wheel Driving Shaft Gear Set Screw |
| 237725 | 14179 | Feed Wheel Stud |
| 201697c | 14179 | " " " Nut |
| *203482 | — | Hook (sewing) |
| 237726 | 14181 | " 203482 with 201253F, 201376F and 221148 |
| 237727 | — | Hook and Bobbin Case complete, Nos. 203521 and 237726 |
| 235755 | 14181 | Hook Bevel Gear Socket, 18 teeth |
| 235527 | 14181 | " " " " Bushing (lower) (brass) |
| 200362c | 14179 | Hook Bevel Gear Socket Bushing (lower) Set Screw |
| 235756 | 14181 | Hook Bevel Gear Socket Bushing (upper) (brass) |
| 449c | 14181 | Hook Bevel Gear Socket Bushing (upper) Set Screw |
| 200555H | 14181 | Hook Bevel Gear Socket Screw .. |
| 235635 | 14181 | " " " " Thrust Washer |
| 235529 | 14181 | Hook Driving Bevel Gear with two 350089c |
| 350089c | 14181 | Hook Driving Bevel Gear Set Screw |
| 237728 | 14190 | " " Shaft |
| 235857 | 14181 | " " " Bevel Gear with 200374c and 200396c |

| No. | Plate | Name |
|---------|-------|--|
| 237729 | 14180 | Hook Driving Shaft Bevel Gear Housing with 200346c and three 200362c |
| 237730 | 14180 | Hook Driving Shaft Bevel Gear Housing Cap (bottom) |
| 237731 | 14180 | Hook Driving Shaft Bevel Gear Housing Cap (bottom) Gasket .. |
| 237732 | 14180 | Hook Driving Shaft Bevel Gear Housing Cap (side) |
| 237733 | 14180 | Hook Driving Shaft Bevel Gear Housing Cap (side) Gasket |
| 200053c | 14181 | Hook Driving Shaft Bevel Gear Housing Cap Screw (4) |
| 201082E | 14181 | Hook Driving Shaft Bevel Gear Housing Screw (long) |
| 225532 | 14187 | Hook Driving Shaft Bevel Gear Housing Sirew (long) Washer .. |
| 201308E | 14181 | Hook Driving Shaft Bevel Gear Housing Screw (short) |
| 200396c | 11607 | Hook Driving Shaft Bevel Gear Position Screw |
| 200374c | 14181 | Hook Driving Shaft Bevel Gear Set Screw |
| 237734 | 14181 | Hook Driving Shaft Bushing (back) |
| 200362c | 14179 | " " " " " Set Screw |
| 235531 | 14181 | Hook Driving Shaft Bushing (front) |
| 200347c | 14181 | " " " " " Set Screw |
| 221743 | 14179 | Hook Driving Shaft Collar with two 200380c |
| 200380c | 14179 | Hook Driving Shaft Collar Set Screw |
| 221148 | 14181 | Hook Gib |
| 201376F | 14181 | " " Hinge Screw |
| 201253F | 14181 | " " Screw |
| 237735 | 14180 | " Saddle with 449c, 200347c and three 200362c |
| 235534 | 14182 | Hook Saddle Oil Cover |
| 201185D | 14182 | " " " " Screw (2) .. |
| 201318E | 14182 | " " " " Stop Screw (2) .. |
| 235535 | — | " " Oiling Felt |
| 202260 | — | " " " Wick |
| 235649 | 14182 | " " " " Cover |
| 200169H | 14182 | " " " " " Screw |
| 201308E | 14181 | " " " " " Screw (2) |
| 213018 | — | " Washer |
| 203507 | 14182 | " " 213018 with 203476 and two 204243 |

| No. | Plate | Name |
|---------|-------|--|
| 208490 | 14190 | Knee Lifter Connection Lever |
| 200262H | 14182 | " " " " Hinge Screw |
| 237766 | 14190 | Knee Lifter Connection Lever Lift- ing Rod with 202302 |
| 202302 | 14182 | Knee Lifter Connection Lever Lift- ing Rod Cotter Pin |
| 237805 | 14189 | Knee Lifter Lifting Lever |
| 200262H | 14182 | " " " " Hinge Screw |
| 207807 | 14187 | Knife |
| 200368H | 14187 | " Adjusting Screw |
| 237932 | 14190 | " Bar |
| 237807 | 14187 | " Angle Extension |
| 200126E | 14187 | " " " " Screw (2) |
| 221417 | 14190 | " " Driving Eccentric with 200382c and 200437c |
| 202890 | 14190 | Knife Bar Driving Eccentric Fork with 200382c and 201464c |
| 201464c | 14187 | Knife Bar Driving Eccentric Fork Position Screw |
| 200382c | 14179 | Knife Bar Driving Eccentric Fork Set Screw |
| 200437c | 14187 | Knife Bar Driving Eccentric Posi- tion Screw |
| 200382c | 14179 | Knife Bar Driving Eccentric Set Screw |
| 202891 | 14192 | Knife Bar Driving Shaft Crank with 200694F and 201525E |
| 203244 | 14187 | Knife Bar Driving Shaft Crank Collar with two 200393c |
| 200393c | 14187 | Knife Bar Driving Shaft Crank Collar Set Screw |
| 200694F | 14187 | Knife Bar Driving Shaft Crank Screw Stud |
| 201525E | 14187 | Knife Bar Driving Shaft Crank Screw Stud Nut |
| 237907 | 14187 | Knife Bar Guide Block |
| 200011E | 14187 | " " " " Screw (2) .. |
| 200404c | 14187 | " " " " Screw |
| 201531E | 14187 | " " " " Nut |
| 237829 | 14187 | " " Lifting Spring |
| 202346 | 14187 | " " " " Plunger .. |
| 237908 | 14191 | " " Position Bracket |
| 201387F | — | " " " " Screw (2) .. |
| 237933 | — | " Holder with 200368H |
| 200898D | 14191 | " " Screw |
| 237939 | — | " " Switch-in Handle |
| 200076D | 14191 | " Screw (2) |

| No. | Plate | Name |
|---------|-------|--|
| 237812 | 14192 | Knife Switch-out Handle with two 200373c |
| 200373c | 14191 | Knife Switch-out Handle Set Screw |
| 202899 | 14192 | " " " Shaft |
| 202900 | 14191 | " " " Spring (spiral) |
| 237736 | 14182 | Needle Bar with 200141r |
| 202552 | 11607 | " " Connecting Link |
| 223687 | — | " " " " Oil Guard |
| 200161D | 11607 | Needle Bar Connecting Link Oil Guard Screw |
| 202333 | 11607 | Needle Bar Connecting Link Stud with 202254 |
| 202254 | — | Needle Bar Connecting Link Stud Oil Packing (wick) |
| 200374c | 11181 | Needle Bar Connecting Link Stud Set Screw |
| 200383c | 14182 | Needle Bar Connecting Link Stud Set Screw |
| *206891 | — | Needle Bar Connecting Stud |
| 202329 | 11607 | " " " " 206891 with 200086c and 202330 |
| 202330 | — | Needle Bar Connecting Stud Oil Packing (wick) |
| 200086c | 11607 | Needle Bar Connecting Stud Pinch Screw |
| 202692 | 14192 | Needle Bar Crank with 200335c, 200374c, 200383c, 200428c and 202333 |
| 237737 | — | Needle Bar Crank 202692 with 202329, 202399, 202400, 202552 and 237762 |
| 203172 | 11607 | Needle Bar Crank Friction Washer |
| 200428c | 11607 | " " " Position Screw .. |
| 200335c | 14176 | " " " Set Screw |
| 237813 | 14192 | " " Rock Frame |
| 237931 | — | " " " " 237813 with 237736 |
| *38127 | — | Needle Bar Rock Frame Driving Eccentric |
| *237749 | — | Needle Bar Rock Frame Driving Eccentric Body |
| 350107c | 14191 | Needle Bar Rock Frame Driving Eccentric Body Position Screw.. |
| 443c | 14182 | Needle Bar Rock Frame Driving Eccentric Body Set Screw |
| 21331 | 14182 | Needle Bar Rock Frame Driving Eccentric Pressure Spring |

| No. | Plate | Name |
|---------|-------|---|
| 21332 | 14182 | Needle Bar Rock Frame Driving Eccentric Pressure Spring Cap.. |
| 934D | 14182 | Needle Bar Rock Frame Driving Eccentric Pressure Spring Cap Screw |
| 1103C | 14182 | Needle Bar Rock Frame Driving Eccentric Regulating Screw |
| 217D | 14191 | Needle Bar Rock Frame Driving Eccentric Set Screw |
| 7071 | 14191 | Needle Bar Rock Frame Driving Eccentric Set Screw Washer ... |
| 237750 | — | Needle Bar Rock Frame Driving Eccentric complete, Nos. 217D, 443C, 934D, 1103C, 7071, 21331, 21332, 38127, 237749 and 350107C |
| 237739 | 14192 | Needle Bar Rock Frame Driving Fork Lever with 200029E |
| 200029E | 14182 | Needle Bar Rock Frame Driving Fork Lever Pinch Screw |
| 237740 | 14182 | Needle Bar Rock Frame Driving Fork Lever Slide Block (two pieces) |
| 210910 | 11607 | Needle Bar Rock Frame Hinge Stud with 202277 |
| 202277 | — | Needle Bar Rock Frame Hinge Stud Oil Packing (wick) |
| 200347C | 14181 | Needle Bar Rock Frame Hinge Stud Set Screw |
| 202667 | 14192 | Needle Bar Rock Frame Rock Shaft |
| 210978 | — | " " " " " " |
| | | 202667 with 200386C and 210920.. |
| 237910 | 14191 | Needle Bar Rock Frame Position Bracket with 200404C and 201531E |
| 350129E | 14191 | Needle Bar Rock Frame Position Bracket Screw (2) |
| 202668 | 11607 | Needle Bar Rock Frame Slide Block |
| 210920 | — | " " " " " " |
| | | 202668 with 201141C |
| 201141C | 14182 | Needle Bar Rock Frame Slide Block Screw Stud |
| 200386C | 11607 | Needle Bar Rock Frame Slide Block Screw Stud Set Screw |
| 200141F | 11607 | Needle Set Screw |
| 207072 | 11607 | Presser Bar Bushing (2) |
| 200352C | 14182 | " " " Set Screw (2).. |
| 202671 | 14182 | " " Lifter |
| 200653C | 14182 | " " " Hinge Screw .. |
| 202672 | 14191 | " " Lifting Releasing Lever Bracket |

| No. | Plate | Name |
|---------|-------|---|
| 200975F | 14191 | Presser Bar Lifting Releasing Lever Bracket Guide Screw |
| 237765 | 14191 | Presser Bar Lifting Releasing Lever Bracket Spring (spiral) |
| 237820 | 14191 | Presser Bar Position Guide |
| 202338 | 14191 | " " " " Lever with 200086F |
| 200086F | 11607 | Presser Bar Position Guide Lever Pinch Screw |
| 200352C | 14182 | Presser Bar Position Guide Set Screw |
| 237821 | 14189 | Presser Bar Spring (flat) |
| 210949 | 14193 | " " " Bracket with 200086C |
| 200086C | 11607 | Presser Bar Spring Bracket Pinch Screw |
| 200538C | 14193 | Presser Bar Spring Regulating Screw |
| 200948F | 14193 | Presser Bar Spring Support Screw |
| 201954 | — | Roller Presser, $\frac{3}{8}$ in. diam., $\frac{1}{4}$ in. face |
| 201955 | 14193 | Roller Presser 201954 with 1528J, 201699C, 350104C and twenty-eight 206417 |
| 203422 | 14193 | Roller Presser Arm |
| 237816 | — | " " " 203422 with 201955 |
| 237817 | — | Roller Presser Arm Bracket 202560 with 200096D and 237816 |
| 200675C | 14193 | Roller Presser Arm Bracket Position Screw Stud |
| 202558 | 14193 | Roller Presser Arm Bracket Spring |
| 202559 | 14193 | " " " " " " |
| | | Stop |
| 200141F | 11607 | Roller Presser Arm Bracket Spring Stop Screw |
| 202560 | 14193 | Roller Presser Arm Bracket (swing) |
| 200096D | 14193 | Roller Presser Arm Screw |
| 206417 | 14193 | " " Ball, $\frac{1}{8}$ in. diameter.. |
| 201699C | 14193 | " " " Cone |
| 202557 | 14192 | " " Bar |
| 350104C | 14193 | " " Hinge Screw |
| 1528J | 14193 | " " " " Nut |
| 237818 | — | Roller Presser and Bar complete, Nos. 200675C, 202557 to 202559, 237817 and two 200141F |
| 237762 | 14193 | Take-up Lever |
| 202399 | 14193 | " " Driving Stud with 202277 |

| No. | Plate | Name |
|---------|-------|--|
| 202277 | — | Take-up Lever Driving Stud Oil Packing (wick) |
| 202400 | 14193 | Take-up Lever Hinge Stud with 202423 |
| 202423 | — | Take-up Lever Hinge Stud Oil Packing (wick) |
| 200363c | 14193 | Take-up Lever Hinge Stud Set Screw |
| 202401 | — | Take-up Lever Oiling Felt |
| 200132E | 14193 | " " " " Screw .. |
| 202402 | 11610 | Tension Disc (back) |
| 210967 | 11610 | " " (front) |
| 210950 | 14193 | " Release Driving Lever with 200394c and 202676 |
| 202676 | 14193 | Tension Release Driving Lever Pin |
| 237819 | 14193 | " " " " " |
| | | Slide Bar |
| 237828 | — | Tension Release Driving Lever Pin Slide Bar 237819 with 200167E and 210952 |
| 202678 | 14193 | Tension Release Driving Lever Pin Slide Bar Spring |
| 200394c | 14194 | Tension Release Driving Lever Set Screw |
| 210951 | 14194 | Tension Release Washer |
| 202407 | 10881 | " Spring |
| 200625F | 11610 | " Stud with 204925 |
| 200061c | 14194 | " " Set Screw |
| 204925 | 11610 | " " Washer |
| 201572B | 10881 | " Thumb Nut |
| 210953 | 11610 | Tension complete, Nos. 200625F, 201572B, 202402, 202407, 202682, 210951 and 210967 |
| 202682 | 11610 | Thread Controller Spring |
| 210952 | 11610 | " " " Stop |
| 200167E | 11610 | " " " " Screw |
| 202412 | 14194 | " Guide |
| 210954 | 11610 | " " (lower) |
| 210955 | 11610 | " " (upper) |
| 200582H | 11610 | " " Screw (3) |
| 210956 | 11610 | " Retainer Bracket with 200397H .. |
| 200582H | 11610 | " " " Screw (2) .. |
| 202091 | 14194 | " " Sleeve |
| 210993 | 11610 | " " " |
| 202092 | 14194 | " " Spring |
| 223844 | 14194 | " " " |
| 204058 | 14194 | " " Stud |
| 210957 | 11610 | " " " |
| 210958 | 11610 | " " " Collar |
| 200366H | 14194 | " " " Set Screw |

| No. | Plate | Name |
|---------|-------|---|
| 200397H | 11610 | Thread Retainer Stud Set Screw.. |
| 210959 | 11610 | Thread Retainer (lower) complete, Nos. 210956 to 210958, 210993 and 223844 |
| 204059 | — | Thread Retainer (upper) complete, Nos. 202091, 202092 and 204058.. |
| 237934 | — | Throat Plate Body, for trimming opposite the needle and .040 and .050 in. to right of seam |
| 237935 | — | Throat Plate Knife Cutting Bar, 56 elongated needle hole, for needle sizes 12 and 13, trims opposite the needle and .040 in. to right of seam |
| 200583H | 14194 | Throat Plate Knife Cutting Bar Screw |
| 691F | 14194 | Throat Plate Screw (2) |
| 237936 | 14194 | Throat Plate complete, 56 elongated needle hole, for needle sizes 12 and 13, trims opposite the needle and .040 in. to right of seam, Nos. 237934, 237935 and two 200583H |
| 237744 | 14192 | Vertical Shaft |
| 237745 | 14194 | " " Bevel Gear (lower) |
| 205508 | 14194 | " " " " " " |
| | | Position Pin |
| 235857 | 14181 | Vertical Shaft Bevel Gear (upper) with 200374c and 200396c |
| 200396c | 11607 | Vertical Shaft Bevel Gear (upper) Position Screw |
| 200374c | 14181 | Vertical Shaft Bevel Gear (upper) Set Screw |
| 237734 | 14181 | Vertical Shaft Bushing (lower) ... |
| 200346c | 14194 | " " " " Set Screw |
| 237746 | 14192 | Vertical Shaft Bushing (upper) ... |
| 200362c | 14179 | " " " " Set Screw |
| 237747 | 14194 | Vertical Shaft Driving Gear with 200374c and 200396c |
| 200396c | 11607 | Vertical Shaft Driving Gear Position Screw |
| 200374c | 14181 | Vertical Shaft Driving Gear Set Screw |
| 237754 | 14194 | Vertical Shaft Oil Leader (lower) (brass) |
| 237755 | 14194 | Vertical Shaft Oil Leader (upper) (brass) |

ACCESSORIES

FOR MACHINE No. 110w115

| No. | Plate | Name |
|---------|-------|---|
| 203470 | 14176 | Bobbin (5) |
| *225482 | — | " Case Screw Driver Blade ... |
| *225483 | — | " " " " Handle |
| 225497 | 12345 | Bobbin Case Screw Driver complete, Nos. 225482 and 225483 .. |
| 237714 | — | Feed Wheel Driving Gear with 200382c and 201220c (for 17½ stitches) |
| 237715 | — | Feed Wheel Driving Gear with 200382c and 201220c (for 19 stitches) |
| 237719 | — | Feed Wheel Driving Pinion with 200382c and 201220c (for 17½ stitches) |
| 237720 | — | Feed Wheel Driving Pinion with 200382c and 201220c (for 19 stitches) |
| 207805 | 14187 | Knife (3) |
| 4822 | 14195 | Roller Presser Hinge Screw Nut Wrench |
| 16 x 4 | — | Needles, two each, sizes 12, 14 and 16 |
| 237757 | — | Drip Pan with four wood screws ½ in., No. 5 |
| 41400 | 12345 | Machine Rest Pin (wood) |
| 36578 | 12345 | Oiler with 36579 |
| 36579 | 12345 | " Spout, 3½ in. long, with 120117 |
| 120117 | — | " " Washer (leather) |
| *225484 | — | Screw Driver Blade |
| *225485 | — | " " Handle |
| 225498 | 12345 | Screw Driver complete, (7¼ in. long), Nos. 225484 and 225485 .. |
| 225554 | 12345 | Wrench (steel) |

BOBBIN WINDER

Swing Automatic, Right Hand

| | | |
|--------|-------|----------------------------------|
| 225453 | 10884 | Frame with 202277 and 225438 ... |
| 225454 | 10884 | " Hinge Pin |
| 202277 | — | " Oil Packing (wick) |

| No. | Plate | Name |
|---------|-------|--|
| 225438 | 10884 | Frame Oil Well Cap |
| 225455 | 10884 | " Spring |
| 225456 | 10884 | " " Plunger |
| 202473 | 10885 | Pulley with 200105c |
| 200105c | 10884 | " Set Screw |
| 225381 | 10884 | Spindle |
| 225444 | 10884 | Stop Latch |
| 200056E | 10884 | " " Screw |
| 225458 | 10884 | " " Thumb Lever |
| 225459 | 10884 | " " " " Hinge Stud |
| 225460 | 10884 | " " " " Joint Stud |
| 202478 | 10884 | " " Trip Lever |
| 200299H | 10884 | " " " " Hinge Screw |
| 225461 | 10881 | Tension Bracket with 201499B |
| 200082D | 10881 | " " Screw |
| 228026 | 10884 | " " " Washer |
| 2102 | 10881 | " Disc |
| 202407 | 10881 | " Spring |
| 201499B | 10881 | " Stud |
| 201572B | 10881 | " " Thumb Nut |
| 225462 | 10881 | Bobbin Winder Tension Bracket complete, Nos. 201572B, 202407, 225461 and two 2102 |
| 225433 | 10885 | Bobbin Winder and Tension Bracket Base |
| 225382 | 10885 | Universal Bobbin Winder complete, Nos. 200056E, 200082D, 200299H, 202473, 202478, 225381, 225433, 225444, 225453 to 225456, 225458 to 225460, 225462, 228026 and two wood screws ¾ in., No. 13, R.H.B. |

KNEE LIFTER

| | | |
|---------|-------|---|
| 227781 | 14189 | Knee Lifter Rock Lever with 200522c and 200529c |
| 227782 | — | Knee Lifter Rock Lever 227781 with two each 202451 and 202452 ... |
| 227787 | 14189 | Knee Lifter Rock Lever 227782 with 202203 and 227784 |
| 202453 | 14189 | Knee Lifter Rock Lever Knee Plate with 200526c |
| 202203 | — | Knee Lifter Rock Lever Knee Plate 202453 with 202454 |
| 202454 | 14189 | Knee Lifter Rock Lever Knee Plate Arm |
| 200522c | 14195 | Knee Lifter Rock Lever Knee Plate Arm Set Screw |

| No. | Plate | Name |
|---------|-------|--|
| 200526c | 14195 | Knee Lifter Rock Lever Knee Plate Set Screw |
| 202451 | 14189 | Knee Lifter Rock Lever Lug with two wood screws $\frac{3}{4}$ in., No. 13H |
| 202452 | 14195 | Knee Lifter Rock Lever Lug Hinge Pin |
| 227784 | 14189 | Knee Lifter Rock Lever Rod, 3 in. long, with 227785 |
| *227785 | --- | Knee Lifter Rock Lever Rod Cap or Oil Guard |
| 200529c | 14195 | Knee Lifter Rock Lever Rod Set Screw |

(Other Knee Lifter parts are listed with parts of machine head)

FOR MACHINE No. 110w120

Same as for No. 110w115 with the following exceptions:

| | | |
|--------|-------|---|
| 207807 | 14187 | Knife (3), in place of 207805 |
| 16 x 4 | --- | Needles, three each, sizes 12 and 14, in place of two each, sizes 12, 14 and 16 |

FEED GEARS

| No. | Plate | Name |
|--------|-------|--|
| 237763 | 14195 | Feed Wheel Driving Gear with 200382c and 201220c (for 12 stitches) |
| 237711 | --- | Feed Wheel Driving Gear with 200382c and 201220c (for 14 stitches) |
| 237712 | --- | Feed Wheel Driving Gear with 200382c and 201220c (for 15 stitches) |
| 237713 | 14179 | Feed Wheel Driving Gear with 200382c and 201220c (for 16 stitches) |
| 237714 | --- | Feed Wheel Driving Gear with 200382c and 201220c (for 17 $\frac{1}{2}$ stitches) |
| 237715 | --- | Feed Wheel Driving Gear with 200382c and 201220c (for 19 stitches) |
| 237751 | --- | Feed Wheel Driving Gear with 200382c and 201220c (for 23 stitches) |
| 237764 | 14195 | Feed Wheel Driving Pinion with 200382c and 201220c (for 12 stitches) |
| 237716 | --- | Feed Wheel Driving Pinion with 200382c and 201220c (for 14 stitches) |
| 237717 | --- | Feed Wheel Driving Pinion with 200382c and 201220c (for 15 stitches) |
| 237718 | 14179 | Feed Wheel Driving Pinion with 200382c and 201220c (for 16 stitches) |
| 237719 | --- | Feed Wheel Driving Pinion with 200382c and 201220c (for 17 $\frac{1}{2}$ stitches) |
| 237720 | --- | Feed Wheel Driving Pinion with 200382c and 201220c (for 19 stitches) |
| 237752 | --- | Feed Wheel Driving Pinion with 200382c and 201220c (for 23 stitches) |

Throat Plates

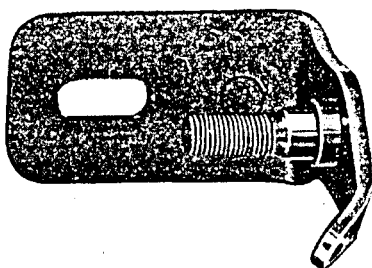
| No. | Plate | Name |
|--------|-------|---|
| 237935 | — | Throat Plate Knife Cutting Bar, 56 elongated needle hole, for needle sizes 12 and 13, trims opposite the needle and .040 in. to right of seam, for 237936 |
| 237929 | — | Throat Plate complete, 56 elongated needle hole, for needle sizes 12 and 13, trims back of needle and .040 in. to right of seam, Nos. 237922, 237925 and two 200583H.. |
| 237936 | 14194 | Throat Plate complete, 56 elongated needle hole, for needle sizes 12 and 13, trims opposite the needle and .040 in. to right of seam, Nos. 237934, 237935 and two 200583H.. |

OBSELETE PARTS

| | | |
|--------|-------|--|
| 237758 | — | Knee Lifter Connection Lever Lifting Rod with 202302 |
| 237906 | — | Knife Bar, for Machine No. 110w120 |
| 237909 | 14191 | " Holder with 200368H, for Machine No. 110w120 |

PLATE 10881—FULL SIZE

225461



200082



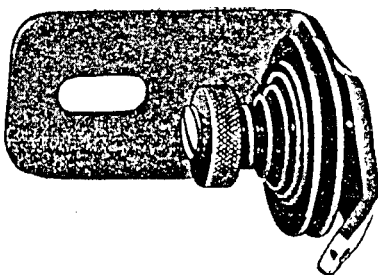
202104



2102



225462



202407



201499

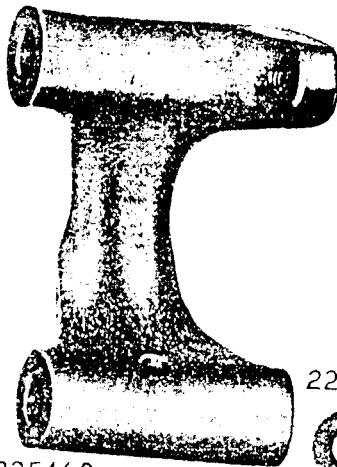


201572

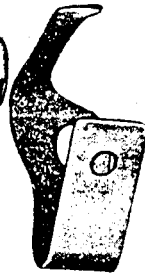


PLATE 10884—FULL SIZE

225453



225444 202478



228026



225458



225460



225454



200299



225438



200056



225459



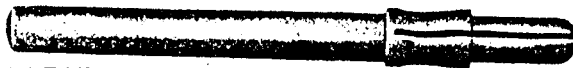
200105



225456



225381



225455

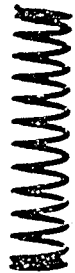


PLATE 10885—ONE-FOURTH SIZE

225433



202473



225382



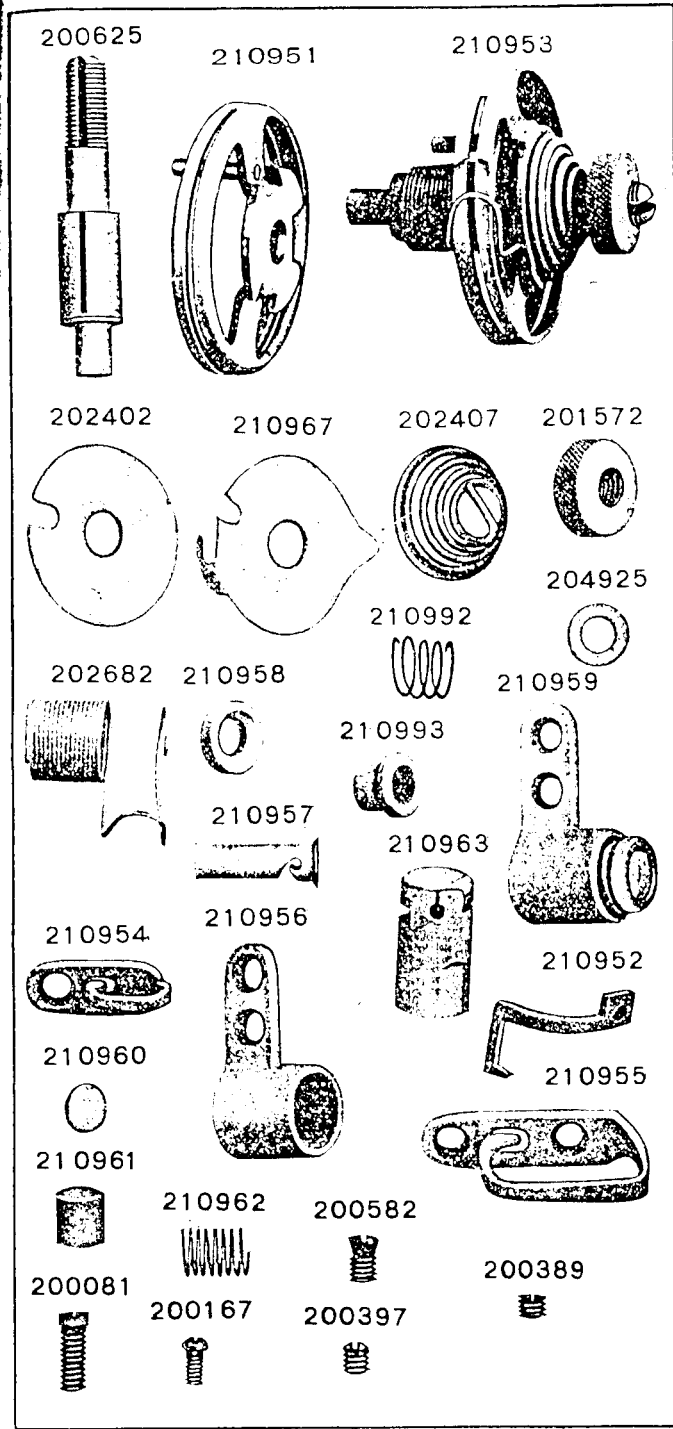
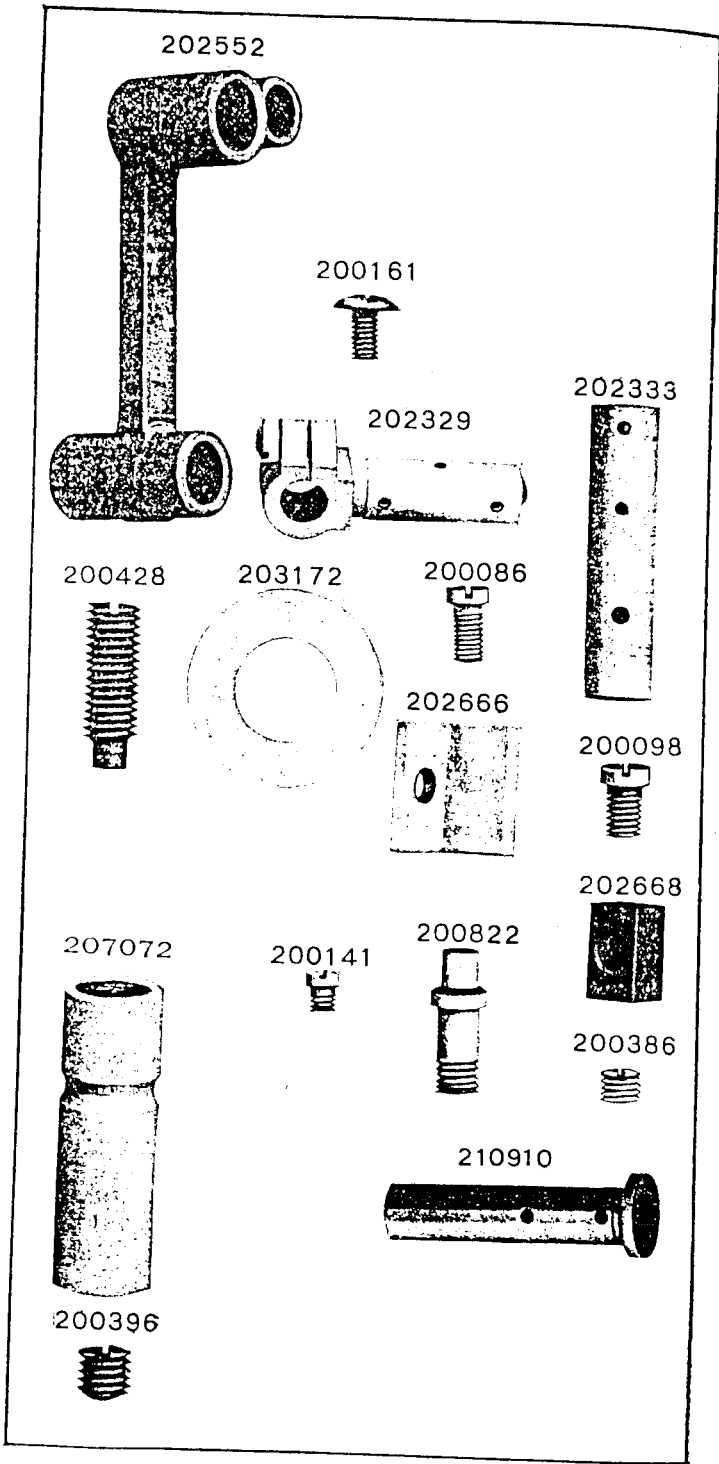


PLATE 12345—ONE-HALF SIZE

PLATE 14176—FULL SIZE

41400



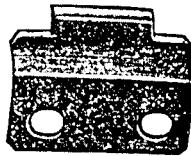
225498



225497



202258



36578

225554



36579



200278 202248 200071 202036 200338



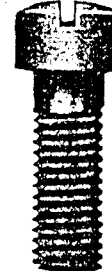
8582



200010



200004



200570



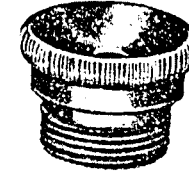
202005



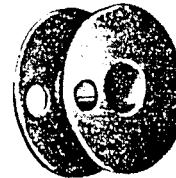
204243



200502



203470



203648

203474



203476



235751



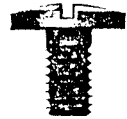
203478



200357



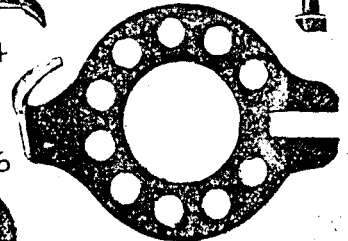
200062



200335



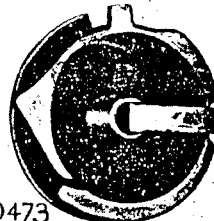
236078



203214

200984

200594



203521

200473



202135

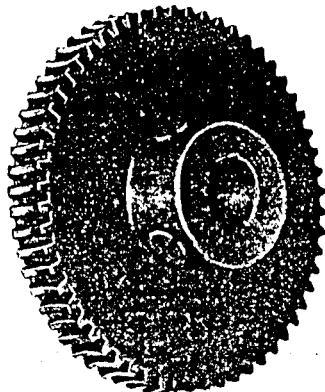


PLATE 14179—FULL SIZE

237723



237724



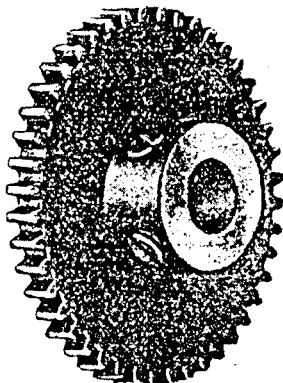
200378



200382



237713



201220



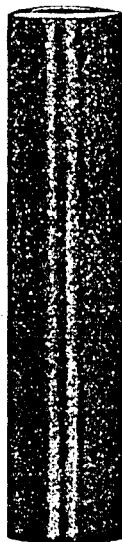
200362



200380



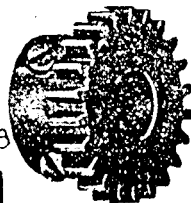
237722



221743



237718



237725

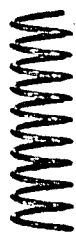


237708



350085

237710

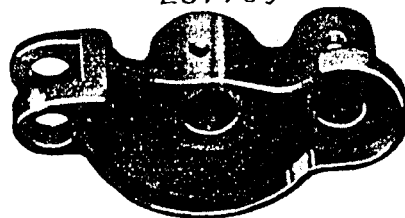


201697

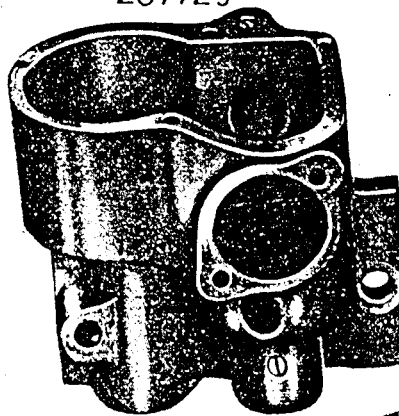


PLATE 14180—ONE-HALF SIZE

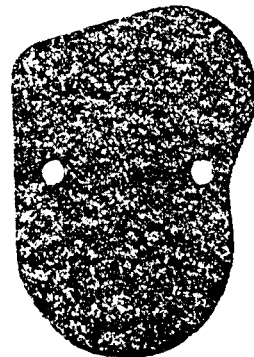
237709



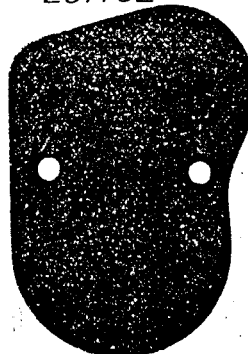
237729



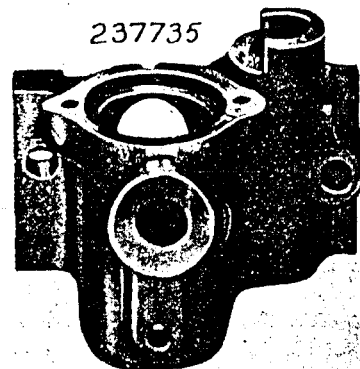
237733



237732



237735



237730

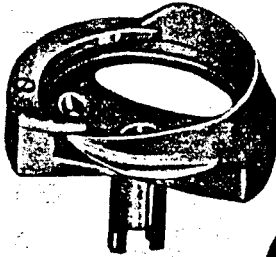


237731



PLATE 14181—FULL SIZE

237726

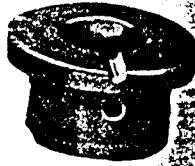


235527



235635

235756

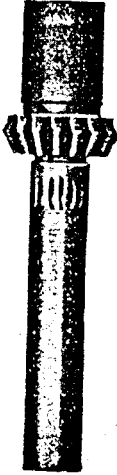


200485

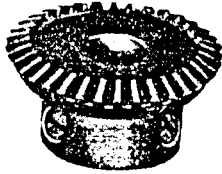
449



235755



235529



201308



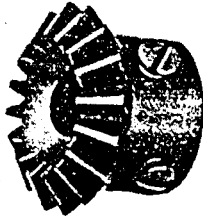
350089



200053



235857



201082



237734

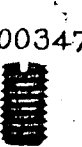


200374



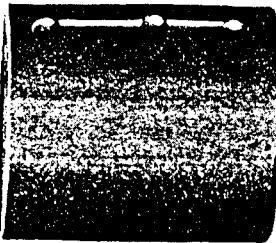
201376

201253



200347

235531



200555

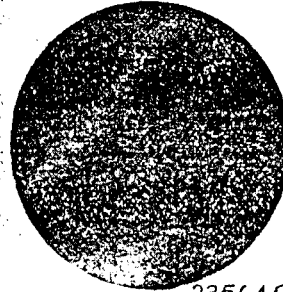


221148



PLATE 14182—FULL SIZE

235534



201185

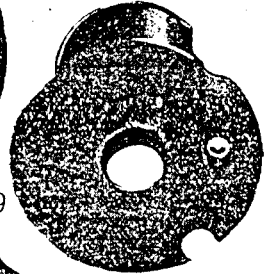


200169



237736

203507



201318



235649



21331

934

202302



202671



200262

21332



202446



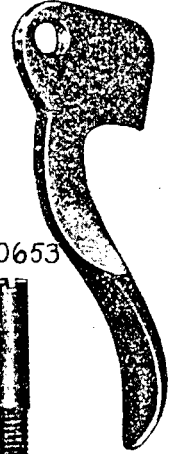
200224



1103

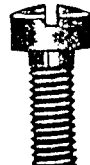


200653



200383 200029

1285



196



237740

443



201141



200352

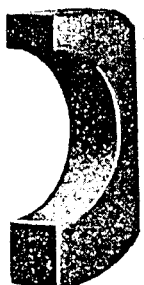
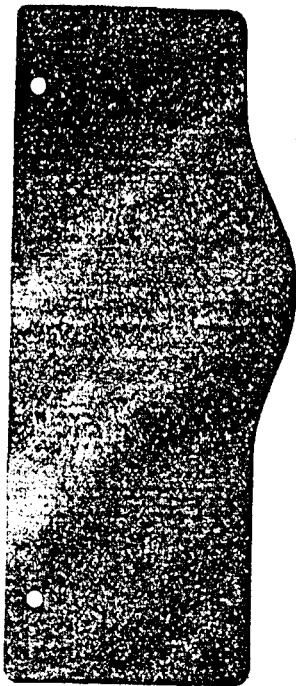
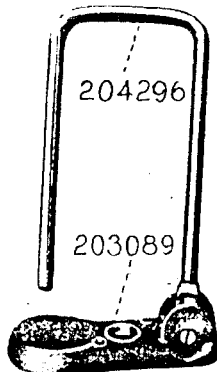


PLATE 14186—ONE-HALF SIZE

237804

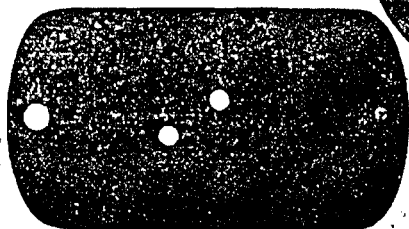


203090



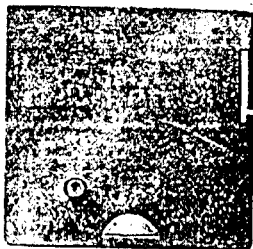
204296

203089

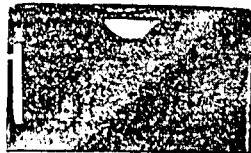


203091

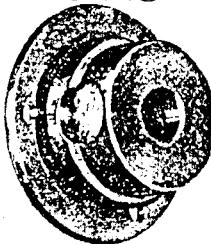
237901



237706



237748



202245



202632

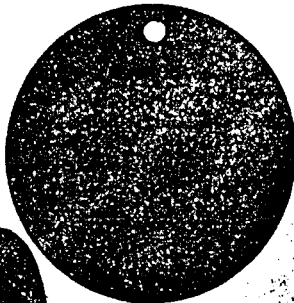


PLATE 14187—FULL SIZE

200585



200079



204235



201220



200246



200368



200126



201464



200437



200393



200694



225708



225532



2023



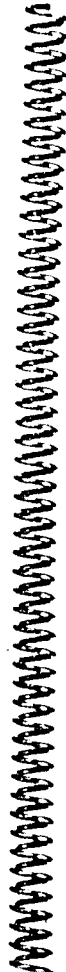
200337



207807



237807 237829



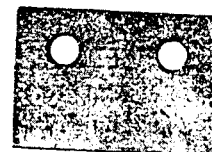
200404



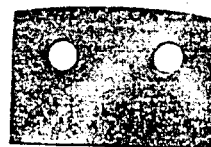
201525



237808



237907



203244



200011



201531



207805



PLATE 14188—FULL SIZE

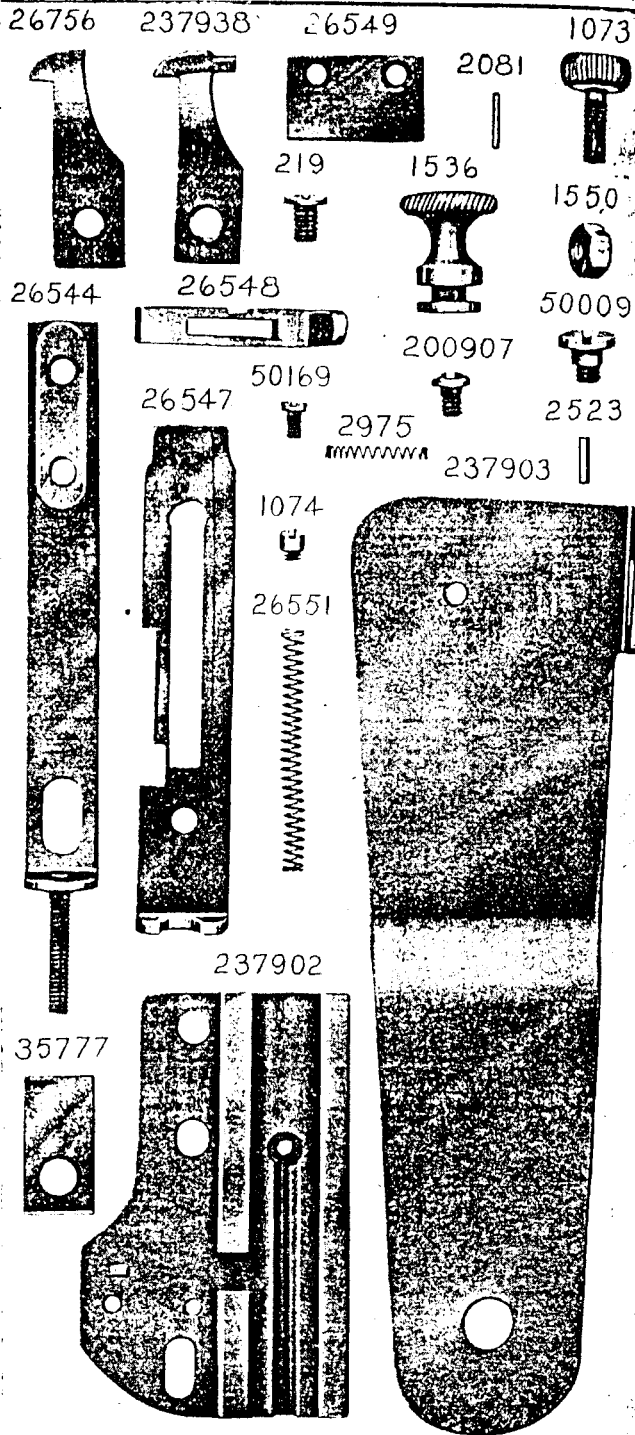


PLATE 14189—ONE-FOURTH SIZE

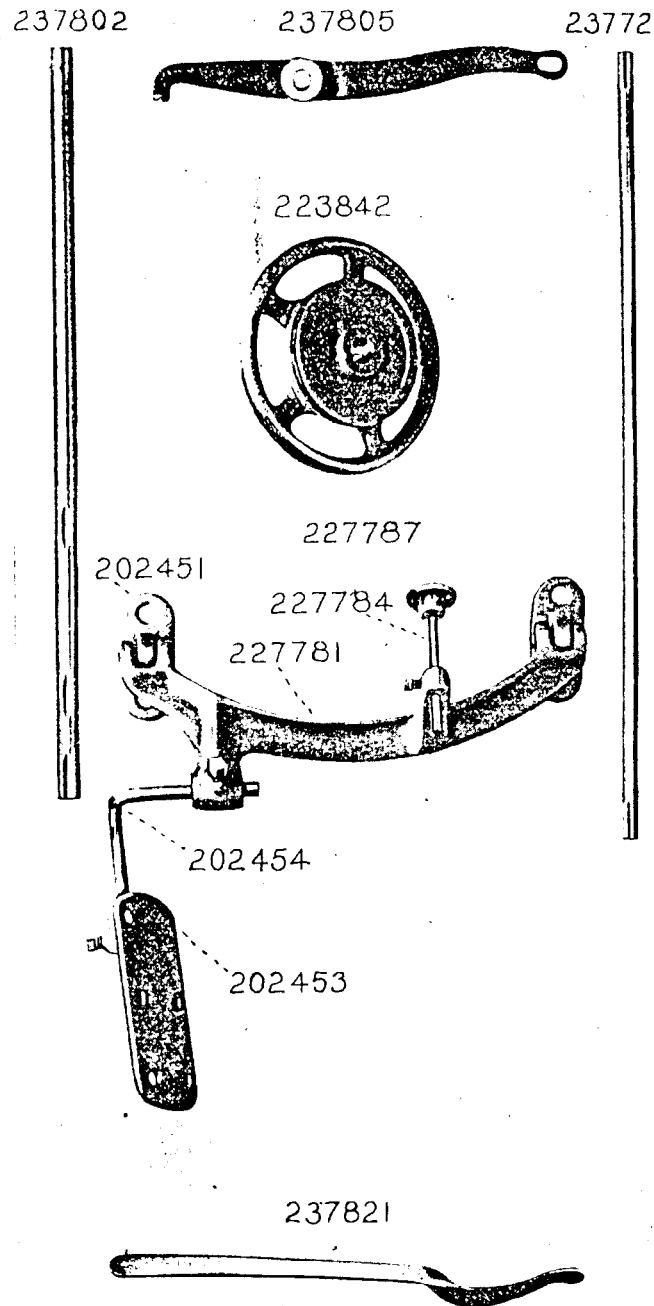
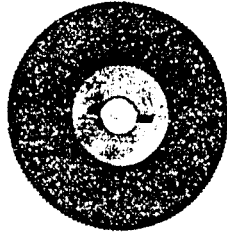


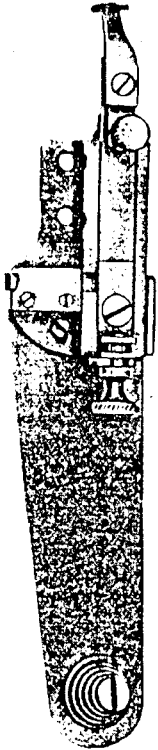
PLATE 14190—ONE-HALF SIZE

237707
237767 237728

237766



237905



221417



237806



237932



208490



202890

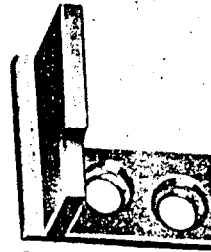


PLATE 14191—FULL SIZE

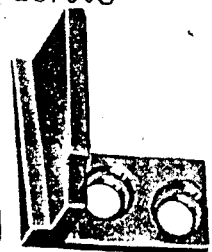
237809

237908

237811



200084



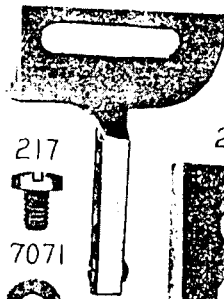
237810



237909



200898



217

237815

200076

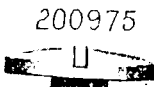


7071



200373

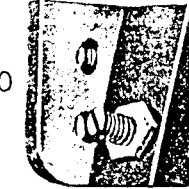
237910



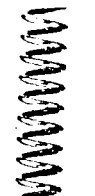
200975



202900



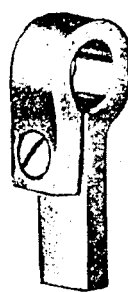
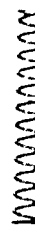
237765



350107

202672

202338



350129



237820

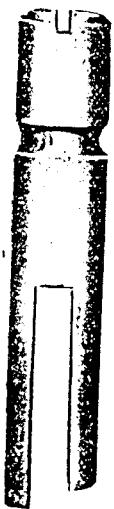


PLATE 14192—ONE-HALF SIZE

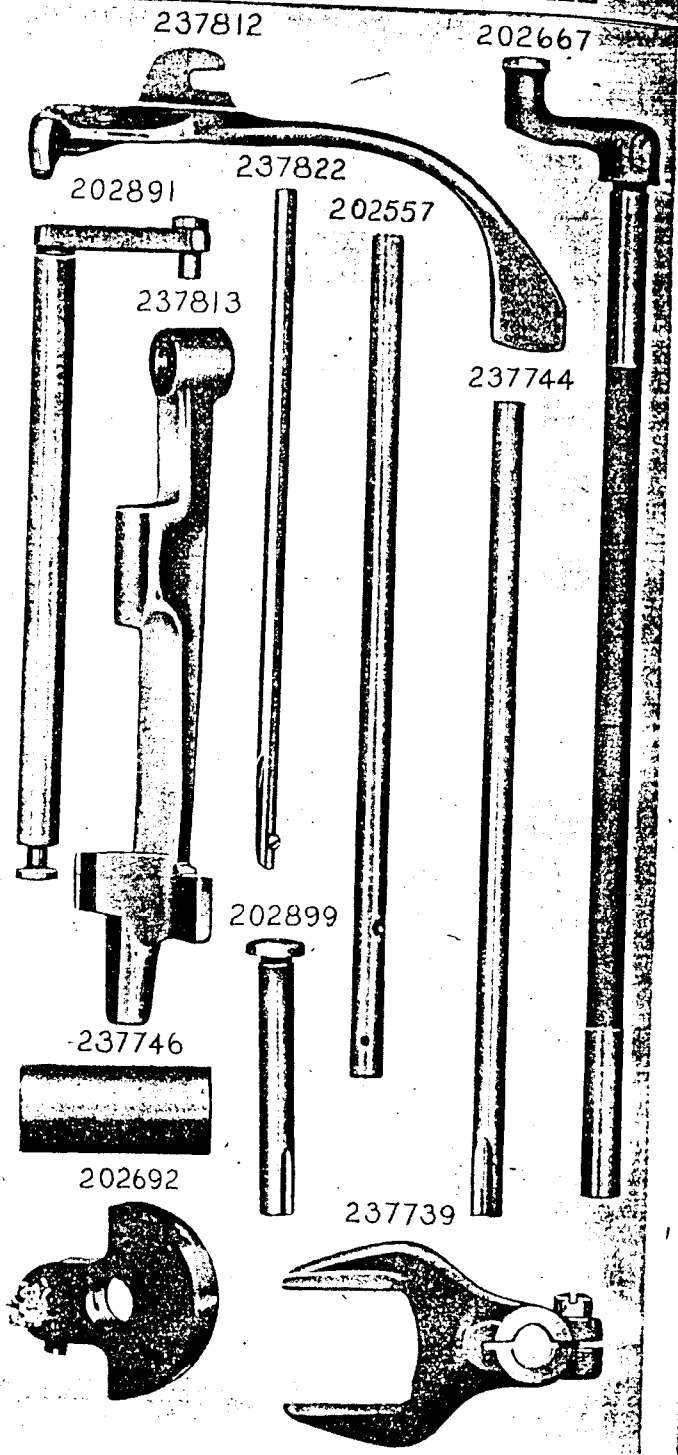


PLATE 14193—FULL SIZE

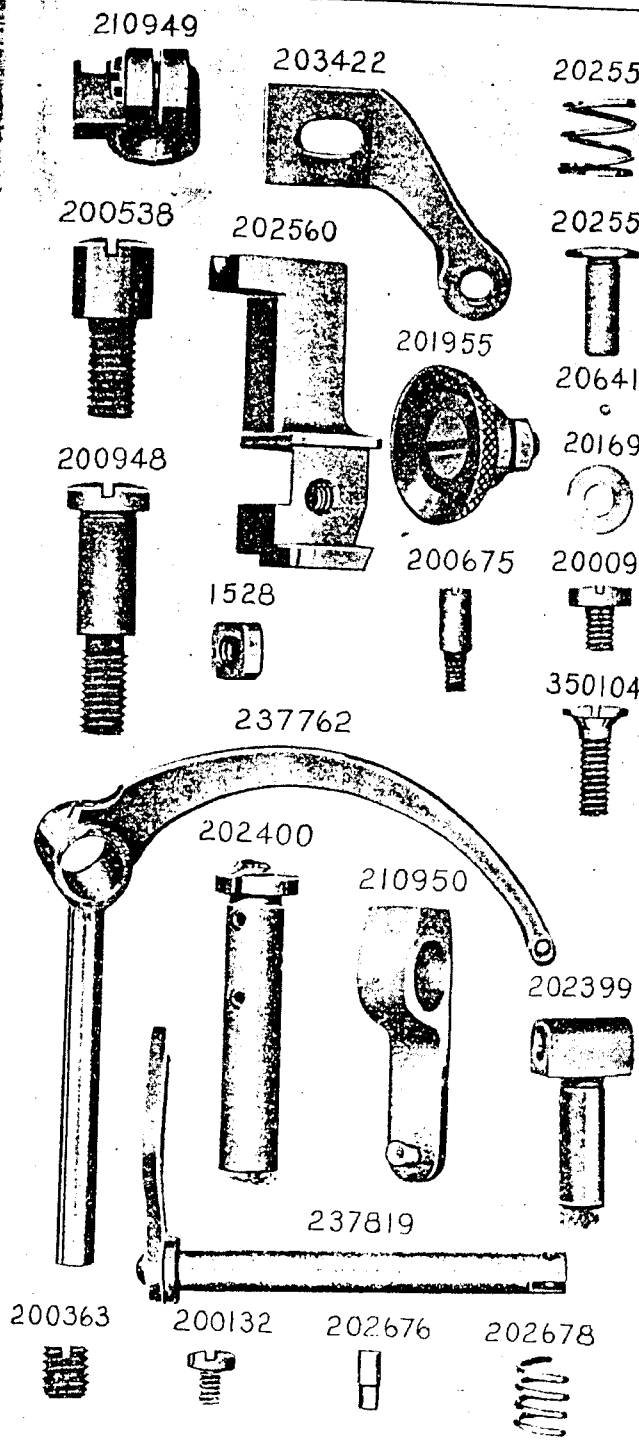
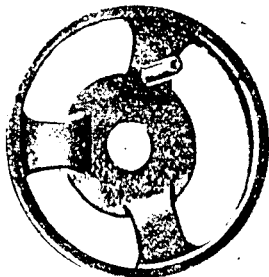


PLATE 14194—FULL SIZE

202412

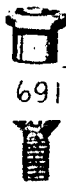


210951



237823

202091

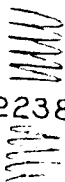


691

200587



202092



223844

204058



200394



200061



200366



200583



211424



211416



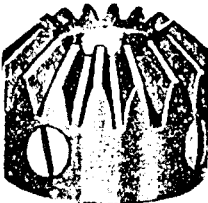
200178



237745



237747



237936



237755



237754

205508



200346

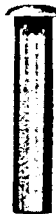


PLATE 14195—FULL SIZE

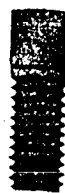
4822



202452



200522



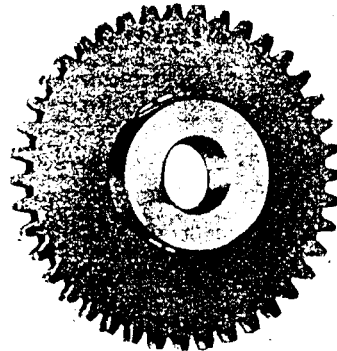
200526



200528



237763



237764

