

Singer 114-36

INSTRUCTIONS FOR OILING

To ensure easy running and prevent unnecessary wear of the parts which are in movable contact, the machine requires oiling and when in continuous use, "TYPE B" or "TYPE D" OIL, sold by Singer Sewing Machine Company, should be applied at least twice each day to all oil holes marked "OIL", as instructed in Form 8428.

"TYPE D" OIL should be used when an oil is desired which will produce a minimum of stain on fabrics, even after a long period of storage.

Copyright, U. S. A., 1917, 1932, 1935 and 1937
by The Singer Manufacturing Company
All Rights Reserved for all Countries

INDEX

	Page
Attachments and Accessories.....	17
Foot Lifter Parts.....	17
Foot Lifter Chain Guide.....	18
Machine No. 114-36.....	5
Numerical List of Parts.....	21
Starting Lever.....	18
Table Belt Guide.....	18
Thread Unwinder.....	19

INSTRUCTIONS FOR ORDERING

In ordering from this list, use **ONLY** the part **NUMBER** in the **FIRST** column.

The number stamped on a Sewing Machine Part is in every case the number of the single part only.

Every combination of parts sent out as such has its specific number, which, although not stamped on the parts, must be used when ordering the combination.

Each number always indicates the **SAME PART** in whatever list it appears, or for whatever machine.

The letters after some of the numbers indicate the style of finish only, as follows:

- A-Hardened, Polished, Nickel Plated and Buffed
- B-Polished, Nickel Plated and Buffed
- C-Hardened Only
- D-Polished Only
- E-Soft, Not Polished
- F-Hardened and Polished

- F,J-Hardened, Polished and Nickel Plated
- G-Bright Rumbled and Nickel Plated
- H-Blued
- J-Nickel Plated Only
- K-Hardened and Nickel Plated
- L-Brass Plated
- M-Oxidized
- N-Japanned, Dull
- P-Japanned, Bright
- R-Merlized

- S-Cadmium Plating
- T-Copper Plated

- T.A-Hardened, Polished, Copper and Nickel Plated and Buffed
- T.B-Copper and Nickel Plated and Polished
- T.J-Copper and Nickel Plated Only
- T.K-Hardened, Copper and Nickel Plated
- T.M-Copper Plated and Oxidized
- T.L-Copper and Brass Plated
- U-Zinc Plated
- V-Silver Plated
- W-Polished and Nickel Plated
- Y-Black Nickel Plated Only
- Z-Chromium Plated
- Z.B-Polished, Nickel Plated, Buffed and Chromium Plated
- Z.J-Nickel and Chromium Plated

These letters **MUST BE USED** when they appear in the list; and **AFTER** the number as in the list.

In this series:

- 1 to 1500, 50001 to 51500 and 140001 to 142000 are Screw Numbers
- 1501 to 1800 and 51501 to 51800 are Nut Numbers
- 1801 to 2000 and 51801 to 52000 are Roller Numbers
- 2001 to 50000 and 52001 to 140000 and 142001 to 190000 are Sewing Machine Parts, 190001 and upward are numbers of Electrical Parts.

The figures in the second column refer only to the plates, illustrating the parts, and are **NOT TO BE USED** in ordering.

Parts marked with an asterisk (*) are furnished only when repairs are made at factory.

LIST OF PARTS COMPLETE

FOR

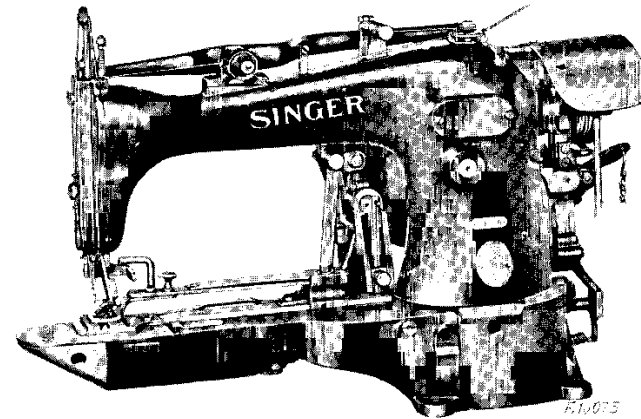

MACHINE No. 114-36

For Covering the Ends of Insulated Electric Conductor Wire.
 Makes thirty-two stitches, including the fastening stitches. The machine is fitted with a special mechanism located on the top of the arm and which is actuated by a special tripping point attached to the feed cam. The purpose of this mechanism is to retard the movement of the needle thread on the last two strokes of the needle so as to draw the last stitch taut. For convenience in changing for the different sizes, the wire holder is made to slide into the feed plate. The machine will tack wire up to and including 1/4 inch in diameter. The machine is fitted with improved thread controlling mechanism and thread nipping device to hold the end of thread until the first stitch is made. Stop motion and mechanism to cut the thread at the completion of the operation.
 Speed 1000 R. P. M.

No.	Plate	Name
*124989	----	Arm.....
*124990	----	" 124989 with 4449, 15404, 124839 and two each 164E and 15405.....
16532	6976	Arm Dowel Pin.....
4448	6976	" Oil Tube for intermediate bearing...

PARTS FOR MACHINE No. 114-36

No.	Plate	Name
58015	6976	Arm Oil Tube, for oiling 59705 and 59706
880E	9555	" Screw.....
59702	9575	" Shaft (horizontal).....
*138541	----	" " " 59702 with 59774, 62235 and 68717.....
17703	9553	Arm Shaft (horizontal) Bushing (back)...
50333C	9555	" " " " Ad- justing Screw.....
1520J	9555	Arm Shaft (horizontal) Bushing (back) Adjusting Screw Nut.....
*4449	----	Arm Shaft (horizontal) Bushing (front)..
59703	6976	" " " Gear with two 1036C.....
1036C	6976	Arm Shaft (horizontal) Gear Set Screw...
59704	6976	" " (upright).....
59705	6976	" " " Bushing (lower).....
448C	9555	" " " " Set Screw.....
59708	6976	Arm Shaft (upright) Bushing (upper).....
448C	9555	" " " " Set Screw.....
59707	6976	Arm Shaft (upright) Gear (lower) with two 1253C.....
1253C	6976	Arm Shaft (upright) Gear (lower) Set Screw.....
59708	6976	Arm Shaft (upright) Gear (upper) with two 1253C.....
1253C	6976	Arm Shaft (upright) Gear (upper) Set Screw.....
124874	9574	Arm Side Cover.....
190J	9555	" " " Screw.....
18498	9575	Belt Cover.....
59804	----	" " 18498 with 59795 and two 217J
59795	9574	" " Bracket with 184E and 59796..
184E	9555	" " " Screw Stud.....
59796	9585	" " " Stud.....
217J	9555	" " " Screw.....
39222	9573	" Shifter.....
63978	9585	" " Clamp.....
1255J	6976	" " " Screw.....
124991	9585	Clamp with 1220E and 17928.....
124993	9570	" Arm.....
124994	----	Clamp Arm complete, Nos. 1664J, 17714, 124993 and 124995.....
17710	9565	Clamp Arm Hinge Plate.....
1178J	9555	" " " " Screw.....
124995	9585	" " Hook.....
1664J	9555	" " " Nut.....
124996	9585	" " Packing.....
62281	9585	" Lifter.....
190J	9555	" " Screw.....
124711	9585	" Locking Device Latch with two 1057J

PARTS FOR MACHINE No. 114-36

No.	Plate	Name
1057J	9555	Clamp Locking Device Latch Clamping Screw.....
124678	9570	Clamp Locking Device Latch Shaft.....
124696	----	" " " " " 124678 with 124679 and 124823.....
124879	9585	Clamp Locking Device Latch Shaft Crank..
124680	9553	" " " " " " Connection.....
1282C	9555	Clamp Locking Device Latch Shaft Crank Connection Hinge Screw (lower).....
1282C	9555	Clamp Locking Device Latch Shaft Crank Connection Hinge Screw (upper).....
124823	9553	Clamp Locking Device Latch Shaft Crank Pin.....
17928	9553	Clamp Position Stud.....
17712	9570	" Pressure Spring.....
17713	9553	" " " Bracket.....
1177D	9555	" " " " Screw.....
17714	9553	" " " Guide Block.....
1178D	9555	" " " " Screw.....
20437	9553	" " " Washer.....
1220E	9555	" Screw Stud.....
1656J	9558	" Thumb Nut.....
124998	----	Clamp complete, Nos. 1656J, 124991 and 124994.....
*124800	----	Cylinder.....
62189	9570	" Bottom Cover.....
124742	9570	" End Cover.....
124743	----	" " " 124742 with 1034J, 62111, 62113, 62185, 62189, 124744 and four 1477J.....
62185	9553	Cylinder End Cover Bracket.....
62111	9553	" " " " Hinge Pin....
1477J	9555	" " " " Screw.....
124744	9553	" " " " Hinge.....
1477D	9555	" " " " Screw.....
62113	9553	" " " " Spring.....
1034J	9555	" " " " Screw.....
124745	9553	" Oil Well Cover.....
230E	9555	" " " " Screw.....
59711	9570	Face Plate.....
59712	----	Face Plate complete, Nos. 208J, 9544, 9545 59711 and two each 229J, 2107 and 9543.....
164J	9555	Face Plate Screw.....
2107	9553	" " Thread Guard.....
229J	9555	" " " " Screw.....
9543	9553	" " " Nipper Disc.....
9544	9553	" " " " Cover....
208J	9555	" " " " " Screw
9545	9553	" " " " " Spring (light).....

No.	Plate	Name
83940	9554	Feed Across Connection (lever end) with two 896E.....
83941	----	Feed Across Connection (lever end) 63940 with 55381.....
55381	9554	Feed Across Connection (lever end) Ball Stud.....
641C	9555	Feed Across Connection (lever end) Ball Stud Set Screw.....
63942	9554	Feed Across Connection (regulator end) with two 896E.....
63943	----	Feed Across Connection (regulator end) 63942 with 63944.....
63944	9554	Feed Across Connection (regulator end) Ball Stud.....
62115	9554	Feed Across Connection Adjusting Stud...
1649C	9558	" " " " Nut (left).....
1650C	9558	Feed Across Connection Adjusting Stud Nut (right).....
896E	9555	Feed Across Connection Cap Screw.....
124999	9571	" " Lever with 641C and 1952....
125000	----	" " " 124999 with 136501....
136501	9554	" " " Hinge Stud.....
690J	9555	" " " " Clamping Screw.....
62118	9554	Feed Across Lever Plate with 17741.....
124860	9554	" " " " Cover.....
1094F	9555	" " " " Screw.....
55300	9556	" " " " Steady Pin.....
1952	9556	" " " Roller and Stud.....
124847	9571	" " Regulator.....
124848	----	" " " 124847 with 1188D, 1655E, 14017 and 50324E.....
50599D	9555	Feed Across Regulator Adjusting Screw Stud.....
1678C	9558	Feed Across Regulator Adjusting Screw Stud Nut.....
48244	9556	Feed Across Regulator Adjusting Screw Stud Nut Washer (fibre).....
17738	9556	Feed Across Regulator Adjusting Screw Stud Nut Washer (steel).....
1188D	9555	Feed Across Regulator Hinge Screw.....
62152	9556	" " " Link.....
50324E	9558	" " " " Screw Stud...
1655E	9558	" " " " " Nut
14017	9558	" " " " " Washer.....
17741	9556	Feed Across Regulator Link Stud.....
136502	9575	" Cam with 190J, 17874, 136514, two each 1192C, 124973 and six 335J.....
136503	9572	Feed Cam Driving Worm with 1441C and 1442C.....

No.	Plate	Name
1442C	9558	Feed Cam Driving Worm Position Screw....
1441C	9558	" " " " Set Screw.....
136504	9572	" " " " Wheel with 453C...
3012	9556	" " " " Pin.....
453C	9558	" " " " Set Screw...
18384	9558	" " " Pin.....
1192C	9558	" " Set Screw.....
62155	9571	" " Shaft.....
136505	----	" " 62155 with 1653C and 136504.....
1653C	9558	Feed Cam Shaft Nut.....
136506	9572	" Plate.....
*18445	9571	" Carrier Bar.....
136507	----	Feed Plate Carrier Bar 18445 with 934J, 1094F, 1195E, 17743, 18368, 62118, 124860 two 55300 and four 17806.....
59730	9556	Feed Plate Carrier Bar Pivot Block.....
50306D	9558	" " " " Screw.
18368	9556	" " " " Plate.....
934J	9558	" " " " Screw.....
1654C	9558	" " Nut.....
17806	9556	" " Position Stud.....
1195E	9558	" " Screw Stud.....
136508	9571	" Regulator with 1953.....
136537	----	" " 136508 with 39313 and 136509.....
136509	9571	Feed Regulator Bracket with 690J and two 160J.....
160J	9558	Feed Regulator Bracket Cap Screw.....
8589	9556	" " " Dowel Pin.....
1177J	9555	" " " Screw.....
17744	9556	" " Hinge Stud.....
17743	9556	" " Post.....
1953	9556	" " Roller and Screw Stud with 1655C and 14017.....
1655C	9558	Feed Regulator Roller and Screw Stud Nut
14017	9556	" " " " " Washer.....
1190C	9558	Feed Regulator Stop Screw.....
39313	9556	" " Swivel.....
1191W	9558	" " Thumb Screw.....
136511	9557	Knife.....
665J	9558	" Screw.....
136512	9557	" Thread Puller.....
62124	9575	" " " Bar with 62130 and two 3021.....
124933	9557	Knife Thread Puller Bar Check.....
124934	9557	" " " " " Plunger...
124935	9557	" " " " " Case
1186J	9558	" " " " " Screw.....
1722J	9558	Knife Thread Puller Bar Check Plunger Lock Nut.....

No.	Plate	Name
1722J	9558	Knife Thread Puller Bar Check Plunger Nut.....
124938	9557	Knife Thread Puller Bar Check Plunger Spring.....
51120J	9558	Knife Thread Puller Bar Check Regulating Screw.....
51591J	9558	Knife Thread Puller Bar Check Regulating Screw Lock Nut.....
50152J	9558	Knife Thread Puller Bar Check Screw.....
124938	----	Knife Thread Puller Bar Check complete, Nos. 51120J,51591J,124933 to 124935, 124938 and two 1722J.....
62126	9557	Knife Thread Puller Bar Connection with 17917.....
17915	9557	Knife Thread Puller Bar Connection Slide Block.....
17917	----	Knife Thread Puller Bar Connection Slide Block 17915 with 17916.....
17916	9557	Knife Thread Puller Bar Connection Slide Block Stud.....
59734	9572	Knife Thread Puller Bar Driving Lever with 223F and 59735.....
*59805	----	Knife Thread Puller Bar Driving Lever 59734 with 1382F.....
1382F	9558	Knife Thread Puller Bar Driving Lever Hinge Screw.....
1681C	9558	Knife Thread Puller Bar Driving Lever Hinge Screw Nut.....
59735	9557	Knife Thread Puller Bar Driving Lever Lock Stud.....
223F	9558	Knife Thread Puller Bar Driving Lever Lock Stud Screw.....
124787	9557	Knife Thread Puller Bar Guide.....
1235F	9558	" " " " " Screw.....
124908	9559	" " " " Holder with 59739...
62129	9559	" " " " Cap with 59739.....
50018F	9567	Knife Thread Puller Holder Cap Screw....
1547J	9558	" " " " " Nut
59739	9559	" " " " " Stud.....
62130	9559	" " " " " Connection...
3021	9559	" " " " " Rivet.
59739	9559	" " " " " Stud.....
236F	9555	" " " " " Screw.....
124849	9559	Loop Guard.....
208J	9555	" " " " " Screw.....
136513	9559	Looper.....
124761	9559	" Driving Shaft.....
124762	9559	" " " " Bushing.....
52045	9559	" " " " " Packing (cotton).....
1148C	9558	Looper Driving Shaft Bushing Set Screw..

No.	Plate	Name
59707	6976	Looper Driving Shaft Gear with two 1253C
59747	9572	" " " " " Cover.....
190J	9555	" " " " " Screw...
1253C	6976	" " " " " Set Screw....
50274C	9558	" Set Screw.....
124763	9572	" Shaft.....
124764	9559	" " Bushing.....
50189C	9558	" " " " Set Screw.....
124765	9559	" " Coupling with four 50150C..
50150C	9562	" " " " Set Screw.....
62299	9572	Needle Bar with 1072F.....
*39203	9560	" " " " Connecting Link.....
62283	----	" " " " " 39203 with 377C,1518E and 2052.....
377C	9558	Needle Bar Connecting Link Hinge Screw..
1518E	9558	" " " " " Nut
2052	9560	" " " " " Stud with 155C....
155C	9562	" " " " " Set Screw....
62235	9572	" " Crank Wheel with 446C and 1293C.....
1293C	9562	Needle Bar Crank Wheel Position Screw...
446C	9555	" " " " " Set Screw.....
124794	9560	" " Thread Retainer.....
124795	----	Needle Bar Thread Retainer complete,Nos. 1449H,124794,124796 and 124821.....
124796	9560	Needle Bar Thread Retainer Bracket with 853C and two 42639.....
853C	9562	Needle Bar Thread Retainer Bracket Set Screw.....
42639	9560	Needle Bar Thread Retainer Position Pin.
1449H	9562	" " " " " Screw.....
124821	9560	" " " " " Spring.....
124766	9560	" Guard.....
124601	9560	" " " " " Cam with two 465C.....
465C	9562	" " " " " Set Screw.....
2273	9560	" " " " " Pin.....
124767	9575	" " " " " Shaft.....
124792	----	" " " " " 124767 with 2273 and 124766.....
59761	9560	Needle Guard Shaft Collar with two 465C.
465C	9562	" " " " " Set Screw.....
124602	9560	" " " " " Crank with 124974 and two 1253C.....
51857	9560	Needle Guard Shaft Crank Roller.....
124974	----	Needle Guard Shaft Crank Roller complete Nos.51857,124698 and 124699.....
124698	9560	Needle Guard Shaft Crank Roller Bushing.
124699	9560	" " " " " Stud
1253C	6976	" " " " " Set Screw.....
59765	9560	" " " " " Spring.....
59766	9560	" " " " " Collar with 624C.....

No.	Plate	Name
624C	9562	Needle Guard Shaft Spring Collar Set Screw.....
233J	9562	Needle Guard Shaft Spring Screw.....
124768	9560	" " Spreader.....
233J	9562	" " " Screw.....
1072F	9562	" Set Screw.....
2058	9572	Presser Bar.....
17841	9561	" " Collar with two 196C.....
196C	9562	" " " Set Screw.....
17842	9561	" " Guide Bracket with 453C.....
453C	9558	" " " Set Screw.....
124790	9575	" " Lifting Lever.....
124839	9572	" " " Bracket.....
164E	9555	" " " Screw..
1201D	9562	" " " Hinge Screw...
17845	9572	" " " Rod.....
39408	----	" " " " 17845 with 17846.....
17846	----	Presser Bar Lifting Lever Rod Chain....
32675	9561	" " Spring.....
68712	20337	Pulley (loose) 2 3/4 in. diam. with 200584D.....
68713	----	Pulley (loose) 68712 with 68714.....
68714	20337	" " Ball Bearing.....
68715	9561	" " Bushing.....
51387R	9562	" " Cap Screw.....
200584D	9562	" " Oil Plug Screw.....
68716	20337	" (tight) 2 7/8 in. diam.....
68720	----	" " 68716 with 1206C and 17854.....
2022	9561	Pulley (tight) Pin.....
68717	----	Pulleys (ball bearing) complete, Nos. 51387R, 68713, 68715 and 68720.....
17853	9561	Starting Lever.....
1262C	9562	" " Hinge Screw.....
1662C	9562	" " " Nut.....
17854	9561	Stop Cam.....
17855	9561	" " Interlocking Rod.....
124784	9573	" " " Case.....
124985	----	" " " " 124784 with 124774 and two 193J.....
124986	----	Stop Cam Interlocking Rod Case 124985 with 1318D, 17855, 17863, 17864, 39222, 63976 and two 1255J.....
124772	9573	Stop Cam Interlocking Rod Case Bracket..
124987	----	Stop Cam Interlocking Rod Case Bracket complete, Nos. 1182E, 1196C, 1204E, 1254C, 1262C, 1508J, 1662C, 17853, 17859, 17861, 17862, 17872, 17873, 124772, 124986 and two 898J.....
21828	6976	Stop Cam Interlocking Rod Case Bracket Dowel Pin.....

No.	Plate	Name
50372J	9562	Stop Cam Interlocking Rod Case Bracket Screw.....
1204E	9562	Stop Cam Interlocking Rod Case Hinge Screw.....
17859	9561	Stop Cam Interlocking Rod Case Socket Joint.....
898J	9562	Stop Cam Interlocking Rod Case Socket Joint Cap Screw.....
11822	9561	Stop Cam Interlocking Rod Case Spring...
19894	9563	" " " " " " Hook
1695E	9562	" " " " " " Lock Nut.....
17861	9563	Stop Cam Interlocking Rod Case Stop Stud
1254C	9562	" " " " " " Screw Bushing.....
1508J	9562	Stop Cam Interlocking Rod Case Stop Stud Screw Bushing Lock Nut.....
17862	9563	Stop Cam Interlocking Rod Case Stop Stud Spring.....
124774	9563	Stop Cam Interlocking Rod Case Wearing Block.....
193J	9562	Stop Cam Interlocking Rod Case Wearing Block Screw.....
17863	9563	Stop Cam Interlocking Rod Spring.....
17864	9563	" " " " Stop.....
1318D	9562	" " " " " Screw....
3012	9556	" " Pin.....
1206C	9562	" " Screw.....
2102	9563	Tension Disc.....
1560C	9562	" Regulating Thumb Nut.....
1274C	9567	" Screw Stud.....
62506	----	" " " 1274C with 1560C....
13710	9563	" Spring.....
10145	9563	" Thread Guide.....
50370J	9562	" " " Set Screw.....
124809	9563	Thread Controller Sleeve.....
124607	9563	" " " Spring
124808	9563	" " " Collar with 1477F.....
1477F	9555	Thread Controller Spring Collar Set Screw.....
124810	9563	Thread Controller Stud with 56549 and 124831.....
124831	9563	Thread Controller Stud Collar.....
56549	9563	" " " " Pin.....
457C	9562	" " " " Set Screw.....
124811	----	Thread Controller complete, Nos. 124807 to 124810.....
124812	----	Thread Nipper (lower) Blade.....
124813	----	" " " " Carrier with 124819.....
124814	9563	Thread Nipper (lower) Blade Carrier 124813 with 124812 and two 6037.....

No.	Plate	Name
665J	9558	Thread Nipper (lower) Blade Carrier Cap Screw.....
124615	9564	Thread Nipper (lower) Blade Carrier Hinge Stud.....
6037	9564	Thread Nipper (lower) Blade Rivet.....
136514	9573	" " " " Cam.....
335J	9562	" " " " Screw.....
124653	9573	" " " " Connection.....
124618	9564	" " " " Extension
99K	9562	" " " " "
		Hinge Screw.....
208J	9562	Thread Nipper (lower) Connection Extension Screw.....
124619	9564	Thread Nipper (lower) Connection Hinge Stud.....
124620	9573	Thread Nipper (lower) Driving Arm.....
8554	9564	" " " " " Pin...
124621	9564	" " " " Lever with 237K...
124973	9573	" " " " Guide.....
335J	9562	" " " " " Screw.
8554	9564	" " " " " Pin.....
237K	9567	" " " " " Set Screw...
124623	9564	" " " " " Shaft.....
124957	9573	" " " " " Bracket
51188J	9567	" " " " " "
		Screw.....
17738	9556	Thread Nipper (lower) Lever Shaft Bracket Screw Washer (steel).....
1743D	9567	Thread Nipper (upper) Adjusting Thumb Nut.....
59773	9564	Thread Nipper (upper) Body.....
447C	9567	" " " " " Set Screw....
59774	9564	" " " " " Cam with two 50150C.....
50150C	9562	Thread Nipper (upper) Cam Set Screw....
2921	9564	" " " " " Disc.....
12182	9564	" " " " " Guide Pin....
62169	9564	" " " " " Spring.....
59775	9564	" " " " " Eyelet.....
1527J	9567	" " " " " Lock Nut.....
136515	9564	" " " " " Retainer.....
136516	9564	" " " " " Holder
		with 452C.....
136517	9573	Thread Nipper (upper) Retainer Holder Bracket.....
134J	9567	Thread Nipper (upper) Retainer Holder Bracket Screw.....
136518	9573	Thread Nipper (upper) Retainer Holder Driving Arm with 1057E.....
136519	9566	Thread Nipper (upper) Retainer Holder Driving Arm Cam.....
190J	9555	Thread Nipper (upper) Retainer Holder Driving Arm Cam Screw.....

No.	Plate	Name
1057E	9555	Thread Nipper (upper) Retainer Holder Driving Arm Clamping Screw.....
452C	9567	Thread Nipper (upper) Retainer Set Screw
59776	9566	" " " " Stud with 13538...
13538	9566	" " " " " Position Pin.
13539	9566	" " " " " Roller.....
13540	9566	" " " " " " Pin....
2026	9566	" " " " " Spring.....
59777	----	Thread Nipper (upper) Stud complete, Nos. 13539, 13540 and 59776.....
59778	----	Thread Nipper (upper) complete, Nos. 1527J 1743D, 2026, 59773, 59775, 59777, 62169 and two 2921.....
136525	9566	Thread Puller and Wiper Body.....
136526	----	" " " " " 136525 with 707J, 2273, 9309, 49241, 50303K, 136529, 136530 and 136535.....
		1175K
1175K	9567	Thread Puller and Wiper Hinge Screw....
132527	9566	" " " " " Holder.....
136528	----	" " " " " 136527 with 234K, 136531 to 136534 and two 68313.....
136529	9566	Thread Puller and Wiper Jaw (movable)...
50303K	9567	" " " " " Hinge Screw.....
49241	9566	Thread Puller and Wiper Jaw (movable) Releasing Pin.....
136530	9566	Thread Puller and Wiper Jaw (movable) Spring.....
707J	9567	Thread Puller and Wiper Jaw (movable) Spring Screw.....
136535	9566	Thread Puller and Wiper Releasing Lever with 68313.....
9309	9566	Thread Puller and Wiper Releasing Lever Spring.....
68313	9566	Thread Puller and Wiper Releasing Lever Spring Position Pin.....
2273	9560	Thread Puller and Wiper Releasing Lever Hinge Pin.....
136531	9566	Thread Puller and Wiper Switch Plate....
68313	9566	" " " " " " Pin.
136532	9566	" " " " " " Shank
136533	9566	" " " " " " "
		Collar with 239K.....
239K	9567	Thread Puller and Wiper Switch Plate Shank Collar Set Screw.....
136534	9566	Thread Puller and Wiper Switch Plate Spring
234K	9567	Thread Puller and Wiper Switch Plate Spring Screw.....
136536	----	Thread Puller and Wiper complete, Nos. 1175K, 136526 and 136528.....
124625	----	Thread Take-up Body with 62172.....

No.	Plate	Name
42808	9566	Thread Take-up Roller.....
62171	9566	" " " Cap.....
337J	9567	" " " Screw.....
62172	9566	" " " Pin.....
124626	9566	Thread Take-up complete, Nos. 337J, 42808 62171 and 124625.....
691F	9568	Thread Take-up Screw.....
7335	9566	" " Spring.....
32578	9566	" " Regulator.....
453C	9558	" " Set Screw
124844	9568	" " Thread Guide
50370J	9562	" " " " Set Screw.....
136520	9568	Throat Plate with 124615.....
124778	9568	" " Needle Guard.....
206J	9562	" " " " Screw.....
136521	----	Throat Plate complete, Nos. 208J, 208J, 1547J, 50018F, 62129, 124778, 124849, 124908, 136511, 136512, 136520 and two each 236F and 665J.....
691F	9568	Throat Plate Screw.....
*15404	----	Trade Mark.....
15405	----	" " Rivet.....
17872	9556	Trip Lever.....
1196C	9567	" " Hinge Screw.....
17873	9568	" " Spring.....
1183E	9567	" " Screw.....
17874	9568	Tripping Point.....
190J	9555	" " Screw.....
136522	9569	Wire Holder (medium groove).....
136523	9569	" " (narrow groove).....
136524	9569	" " (wide groove).....
51224W	9567	" " Thumb Screw.....

SINGER Needles should be used
in SINGER Machines
These Needles and their Containers
are marked with the
Company's Trade Mark "SIMANCO.**" 1

Needles in Containers marked
"FOR SINGER MACHINES"
are NOT SINGER made needles. 2

ATTACHMENTS AND ACCESSORIES

No.	Plate	Name
124958	9576	Cylinder Base Plate with two 453C.....
18420	9576	" " " Hinge Connection....
18423	9576	" " " " " Hinge Pin.....
453C	9558	Cylinder Base Plate Hinge Connection Hinge Pin Set Screw.....
134E	9567	Cylinder Base Plate Screw.....
124959	----	Cylinder Base Plate (hinged) complete, Nos. 124958, two each 18420, 18423, three wood screws 1 1/4 in. No. 12 and four 134E.....
124975	----	Cylinder Base Plate 124959 with 124966..
124960	9576	Machine Supporting Bracket (lower).....
178J	9569	" " " " Screw.
124961	9576	" " " (upper).....
1396J	9569	" " " " Screw.
124962	9576	" " Link (lower).....
124963	9576	" " " (upper).....
124964	9569	" " Hinge Rivet.....
124965	9576	" " Lock Plate.....
190333	9569	" " " " Lock Stud.....
124964	9569	Machine Supporting Link Lock Plate Rivet
124966	9576	Machine Support complete, Nos. 178J, 1396J 124960 to 124963, 124965, 190333 and four 124964.....
120348	7007	Oiler (copper plated) with 120347.....
120347	7007	" Spout, 8 1/2 in. long.....
11831	7007	Screw Driver (machine).....
28026	7007	" " (shuttle tension).....
4822	7007	Wrench for 1547.....
10875	7007	" " 1518, 1520, 1649, 1650 and 1662.
17905	7007	" " 1176, 1178, 1654, 1855 and 1878.
25200	7007	" " 1527.....
27682	7007	" " 1254 and 1508.....

FOOT LIFTER PARTS

No.	Plate	Name
17876	9575	Treadle with 443C.....
17877	9575	" Pitman Rod (lower).....
17878	9575	" " " (upper).....
17879	9575	" " " Clamp with two 161D..
161D	9587	" " " " Screw.....
17880	9575	Treadle Pitman complete, Nos. 17877 to 17879.....
17881	9574	Treadle Shaft.....
443C	9587	" " Set Screw.....

FOOT LIFTER PARTS

No.	Plate	Name
17882	9574	Treadle Spring.....
17883	9575	" Stand.....
17884	9575	Treadle complete, Nos. 17876, 17881 to 17883 and two wood screws 1 in. No. 10.....
17885	----	Treadle and Pitman complete Nos. 17880 and 17884.....

FOOT LIFTER CHAIN GUIDE

No.	Plate	Name
65883	9574	Chain Guide Bracket.....
2461	9569	" " Pulley.....
65884	9569	" " " Pin.....
65885	----	Foot Lifter Chain Guide complete, Nos. 2461, 65883, 65884 and four wood screws 1 in. No. 10 R.H.B.....

STARTING LEVER

No.	Plate	Name
13351	----	Chain, 46 in. to 55 in. long, with 56864 and 56865.....
Note: When ordering No. 13351, give length required.		
56864	7007	Chain Hook (large).....
56865	9569	" " (small).....
17876	9575	Treadle with 443C.....
17881	9574	" Shaft.....
443C	9567	" " Set Screw.....
17882	9574	" Spring.....
17883	9575	" Stand.....
17884	9575	Treadle complete, Nos. 17876, 17881 to 17883 and two wood screws 1 in. No. 10.....

TABLE BELT GUIDE

No.	Plate	Name
39218	9574	Belt Guide with two 168E.....
168E	9567	" " Set Screw.....
17892	9575	Bracket with two 153E.....
17893	9574	Pulley.....
39219	9574	" Shaft (long) with 17896 and 63973
63973	9574	" " " Wick (braided cotton)
39220	9574	" " (short) with 17896 and 63974
63974	9574	" " " Wick (braided cotton)

TABLE BELT GUIDE

No.	Plate	Name
17896	9569	Pulley Shaft Plug.....
153E	9567	" " Set Screw.....
39221	----	Table Belt Guide complete, Nos. 17892, 39219, 39220, two each 17893, 39218 and three wood screws 1 1/4 in. No. 12..

THREAD UNWINDER

FOR ONE LARGE SPOOL OR ONE LARGE CONE OF THREAD

No.	Plate	Name
225259	8405	Spool Rest with 201018C.....
150203	8405	" " Cushion (felt).....
225388	8405	" " Rod.....
200383C	9567	" " " Set Screw.....
201018C	9567	" " Set Screw.....
202490	8405	" Stand with 200383C.....
225391	8405	Thread Guide.....
60771	9569	" Guide.....
60772	----	" " 60771 with 41635.....
41635	9569	" " Bracket with 175E.....
175E	9569	" " " Set Screw.....
201696J	9567	" " Lock Nut.....
225326	9569	" " Position Cup.....
225324	8405	" " Rod with 208E and 225322...
208E	9555	" " " Screw.....
225322	9567	" " " Washer.....
225260	8405	Thread Unwinder complete, Nos. 150203 201696J, 202490, 225259, 225324, 225326, 225388, 225391 and three wood screws 7/8 in. No. 12.....
27739	20337	Thread Cone (wood) for large cones.....
225390	20337	" " Holder for inverted cones...
Note: Nos. 27739 and 225390 are used with, but not included in 225260.		
60773	----	Thread Unwinder with Thread Guide complete, Nos. 60772 and 225260.....

PLATE 7007—ONE-HALF SIZE

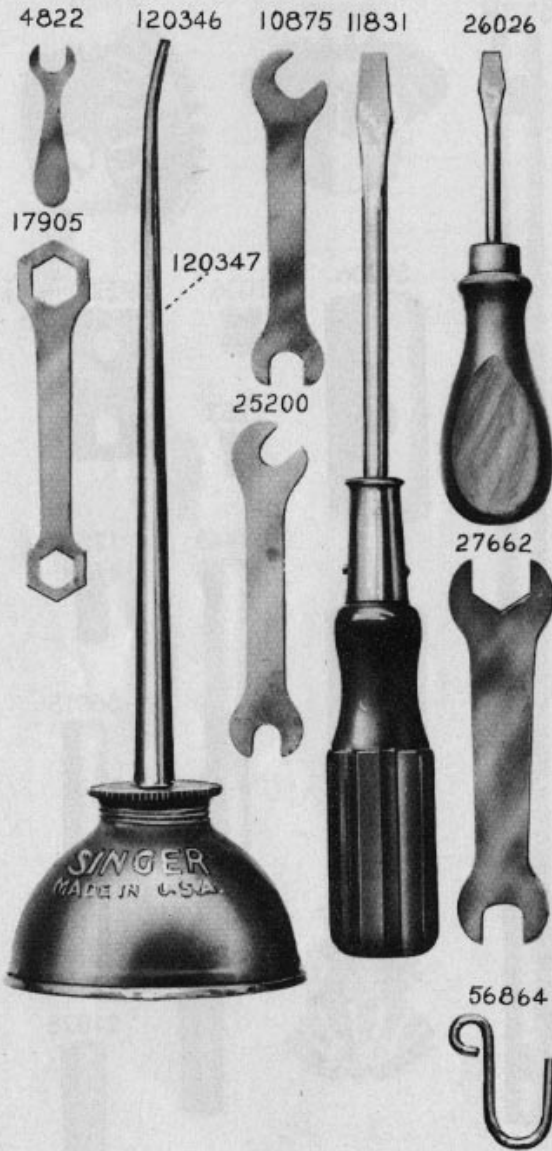

PLATE 8405—ONE-FOURTH SIZE

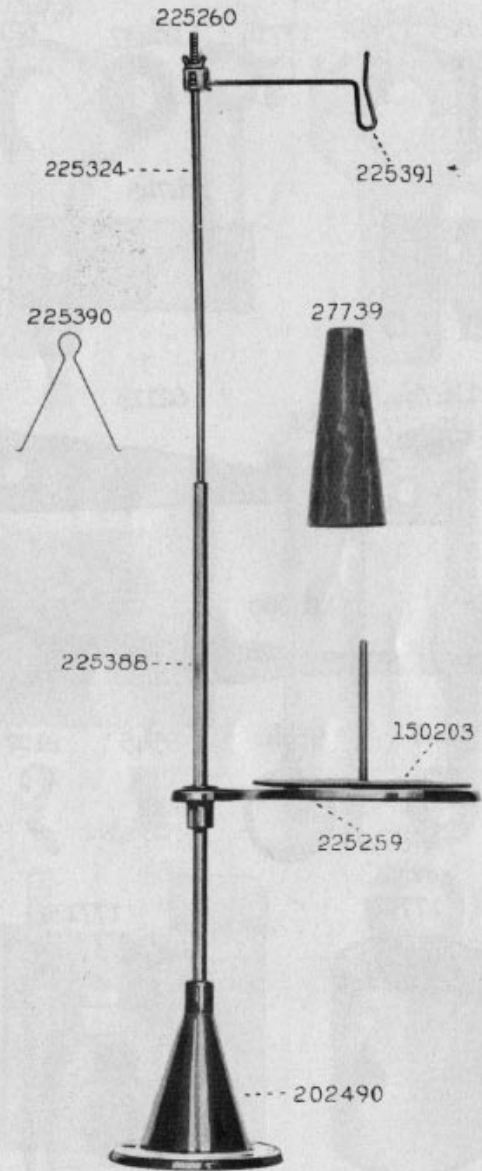

PLATE 9553 - FULL SIZE

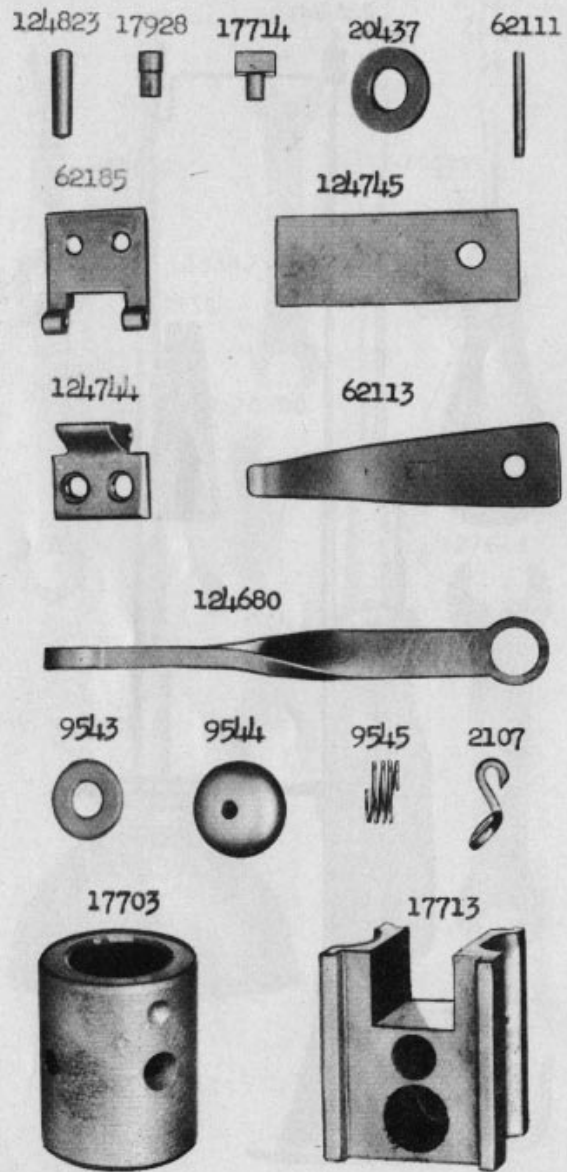

PLATE 9554 - FULL SIZE

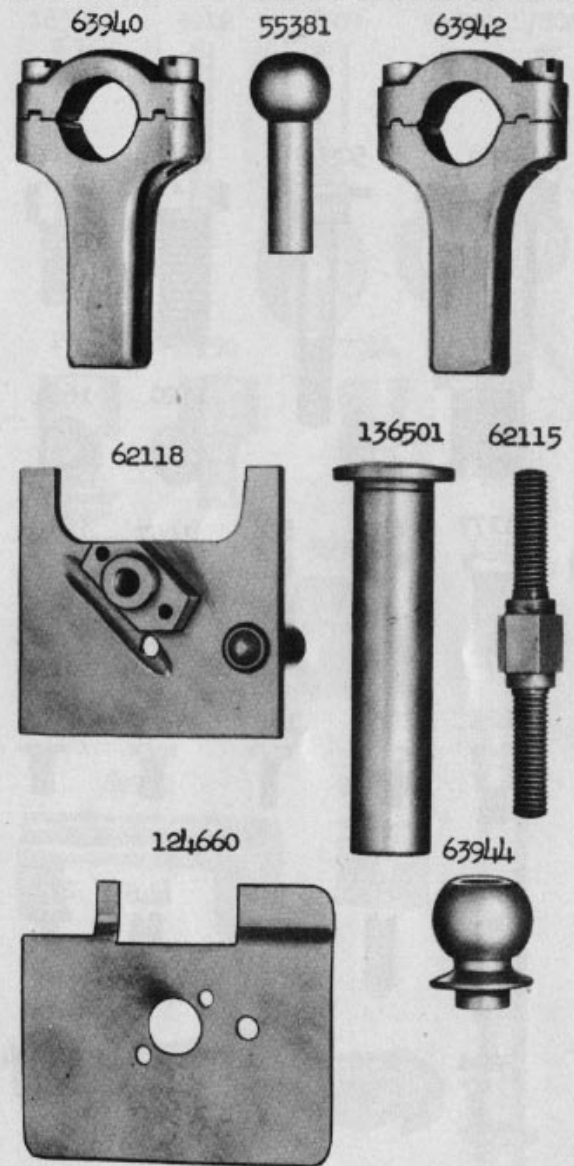

PLATE 9555 - FULL SIZE

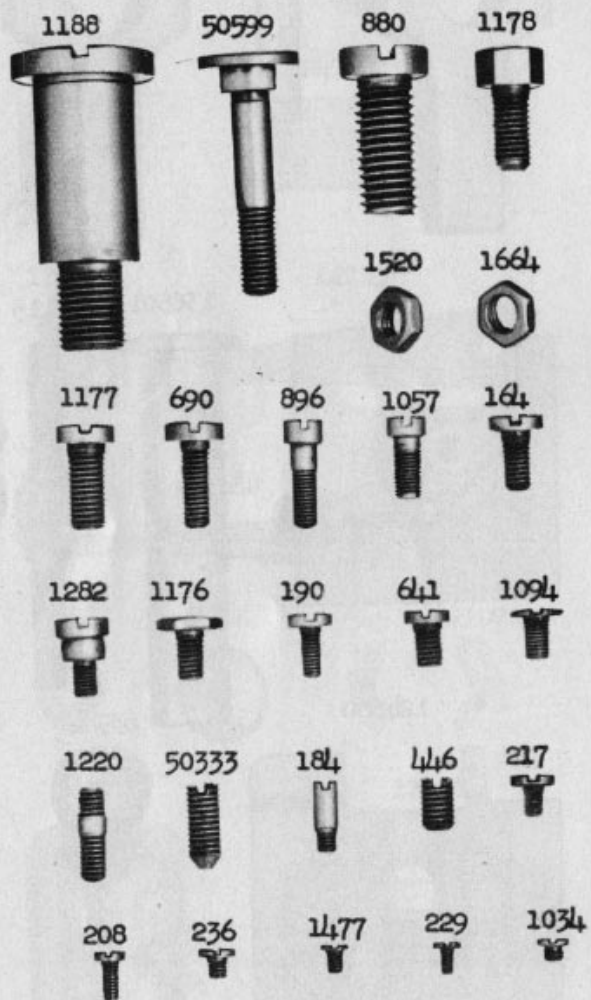

PLATE 9556 - FULL SIZE

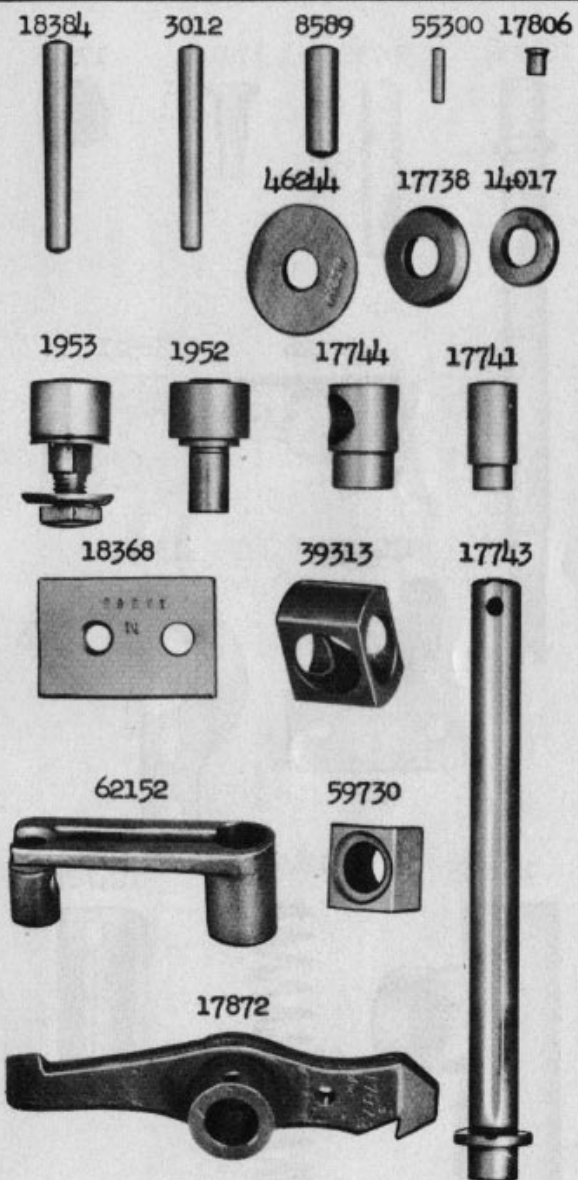

PLATE 9557 - FULL SIZE

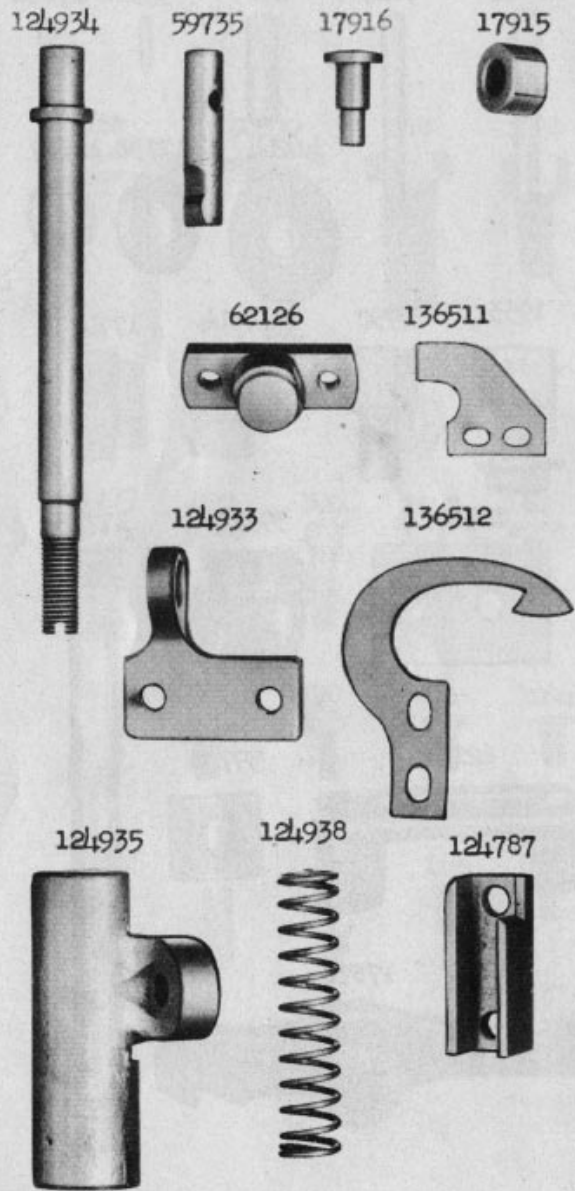

PLATE 9558 - FULL SIZE

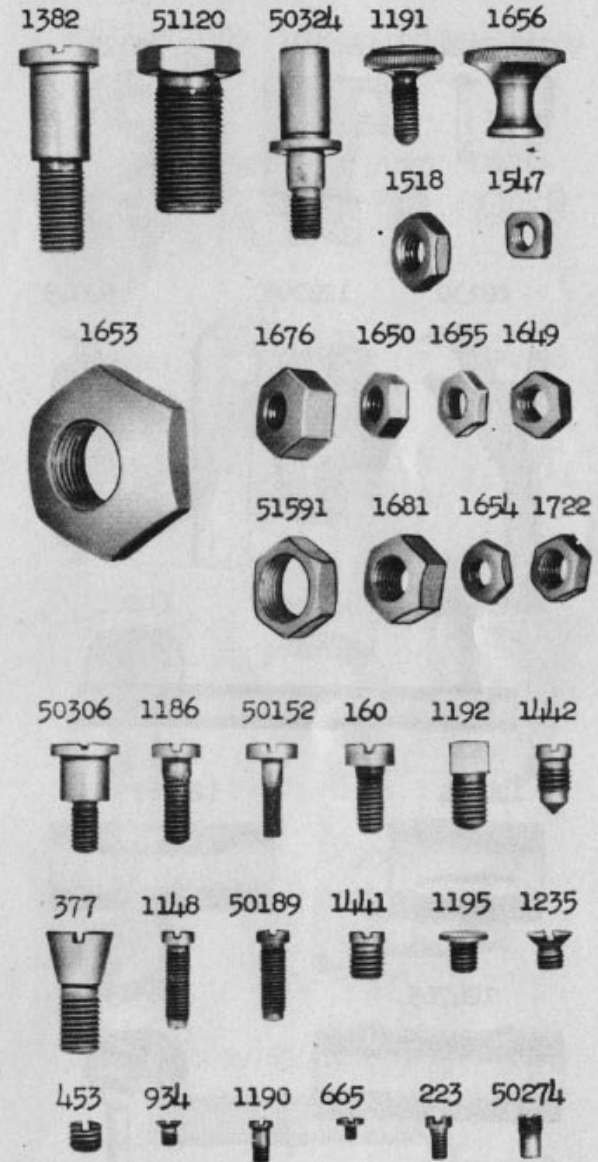

PLATE 9559 - FULL SIZE

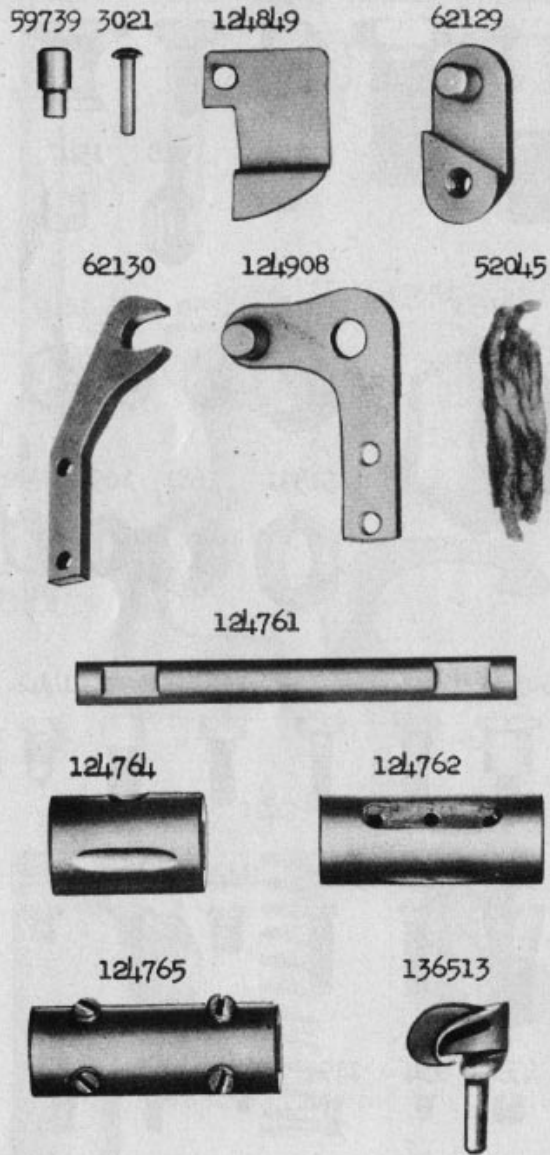

PLATE 9560 - FULL SIZE

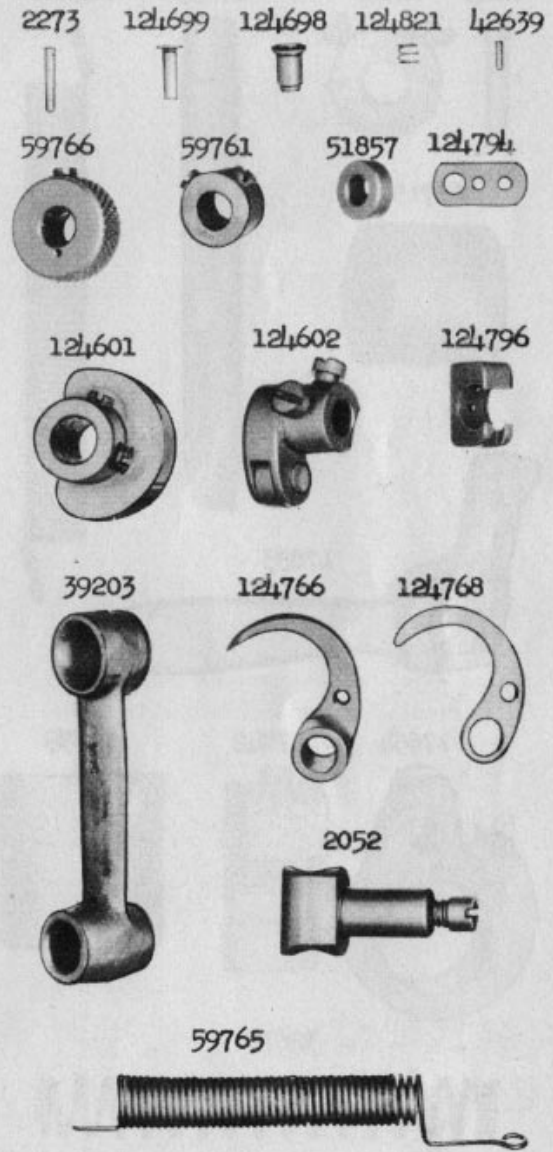

PLATE 9561 - FULL SIZE

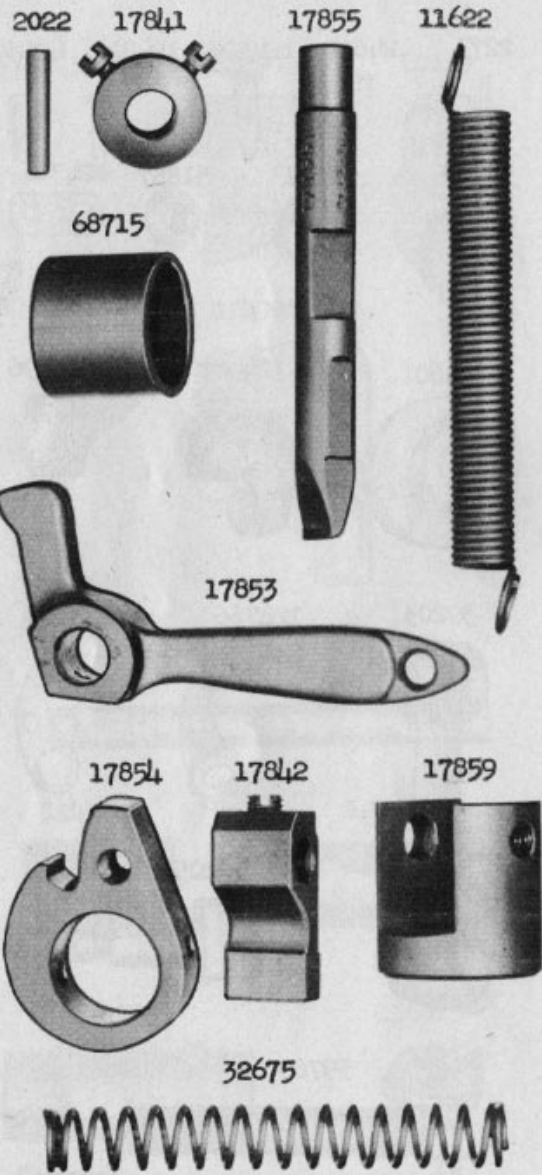
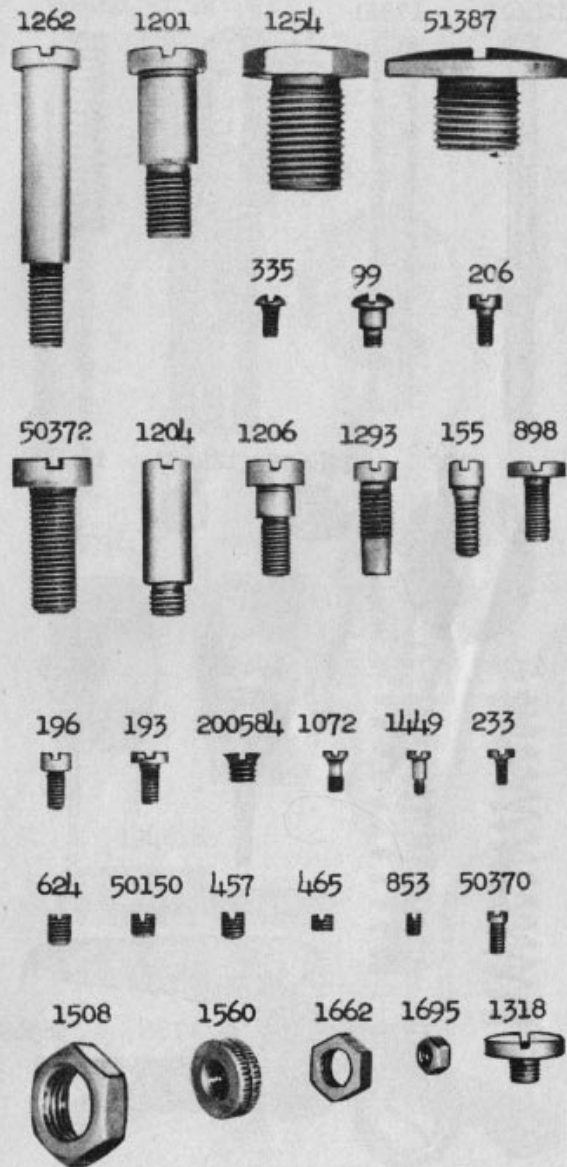

PLATE 9562 - FULL SIZE



1905250

PLATE 9563 - FULL SIZE

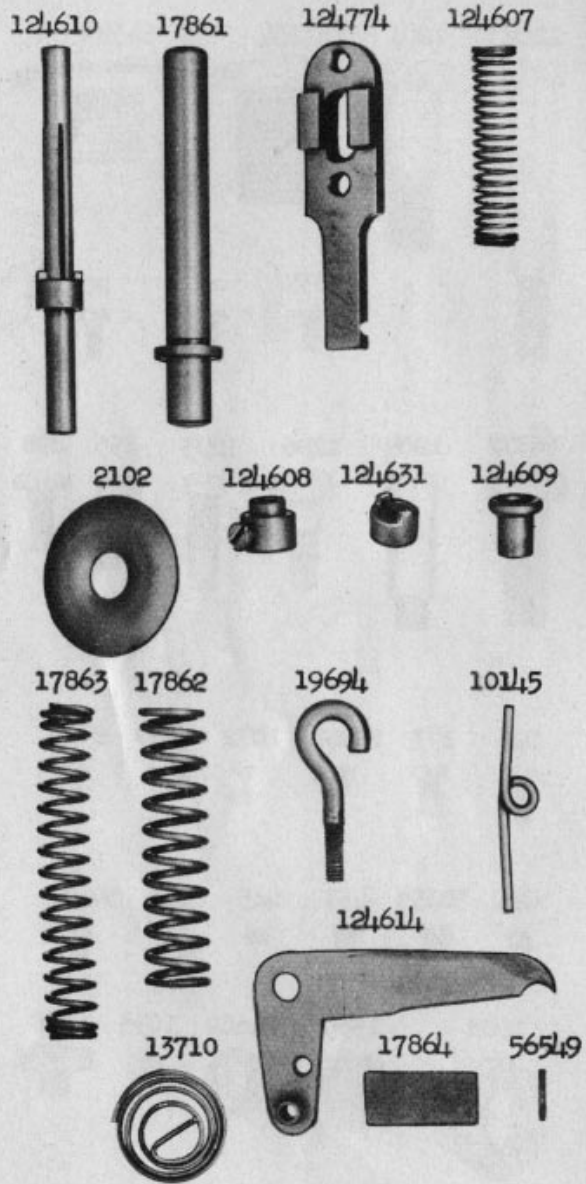

PLATE 9564 - FULL SIZE

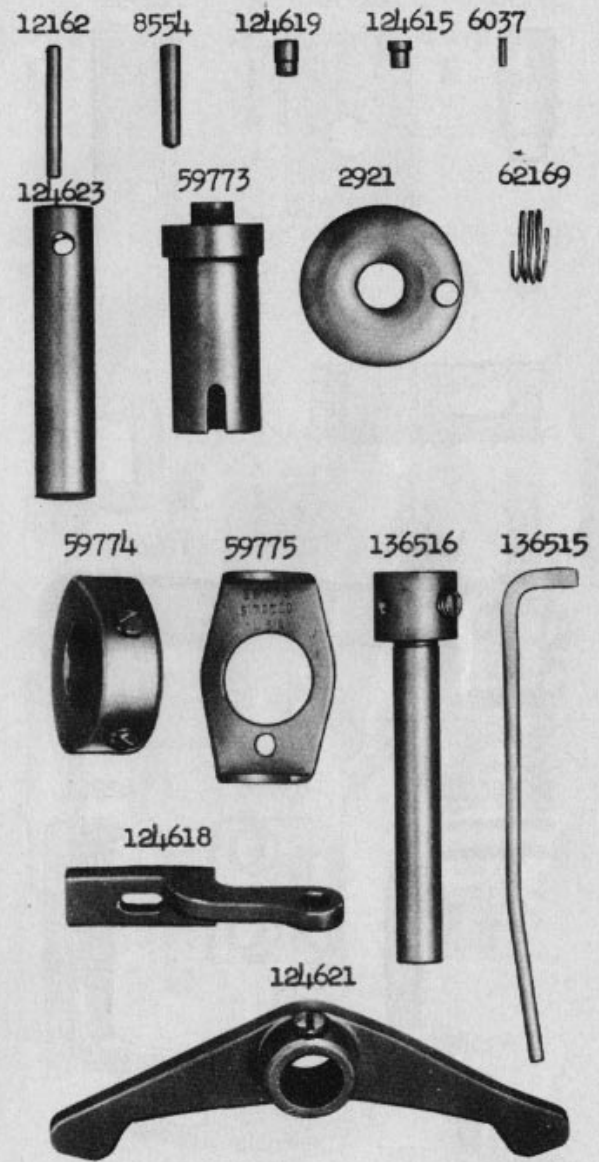

PLATE 9565 - FULL SIZE

59796



124996



124991



17710

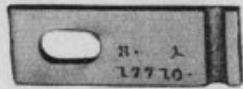

124711

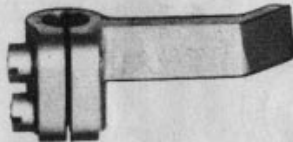

124679



124995

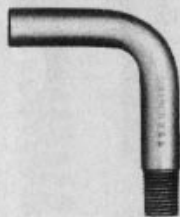

63976



62261

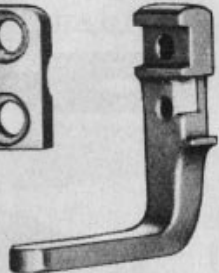
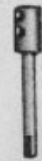

PLATE 9566 - FULL SIZE

136532



13540



13538



49241



62172



68313



2026

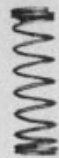

136530

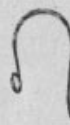

9309



136534



42808



136533



13539



62171



136531



136535



136529



59776



136527

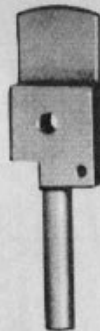

136525



32576



124995

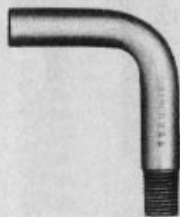

63976



62261

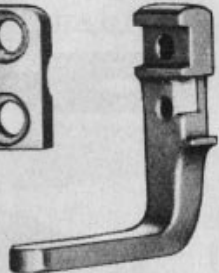

7335



136519



124626



PLATE 9567 - FULL SIZE

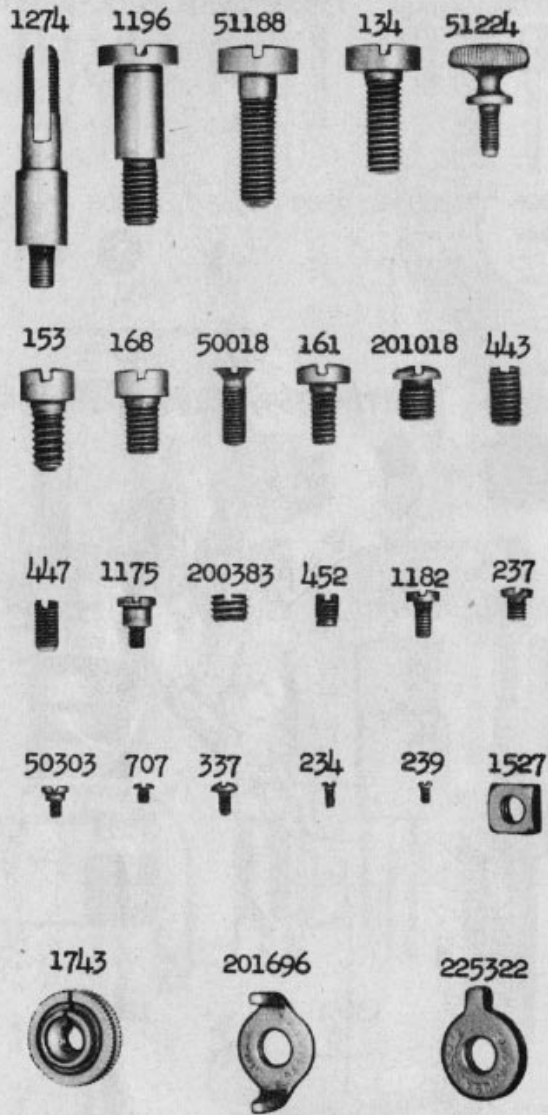

PLATE 9568 - FULL SIZE

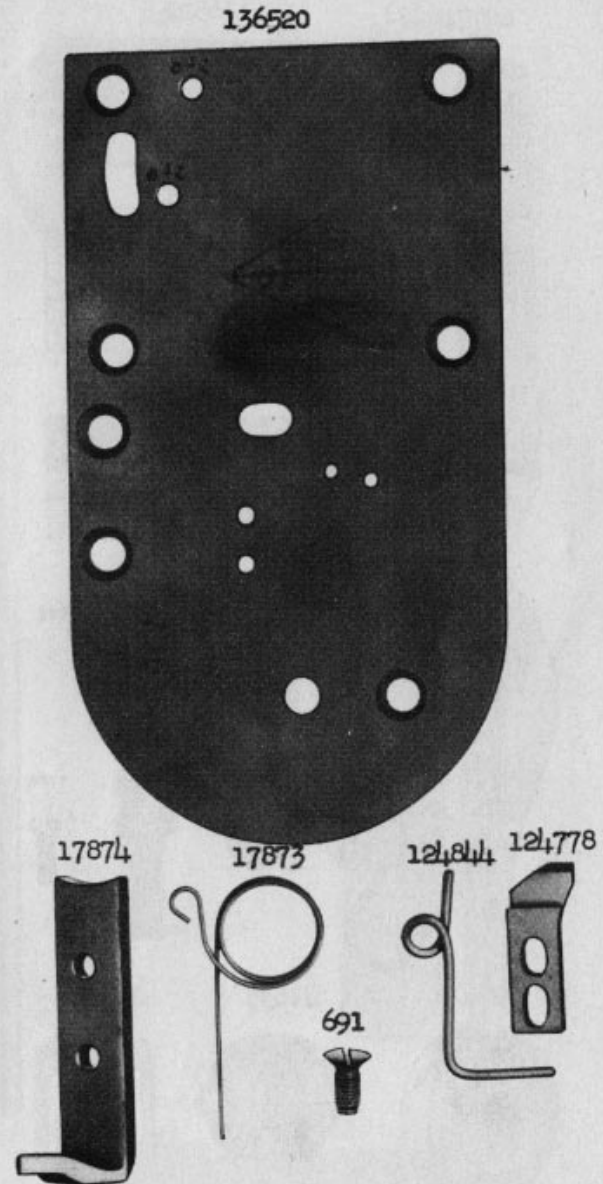

PLATE 9569 - FULL SIZE

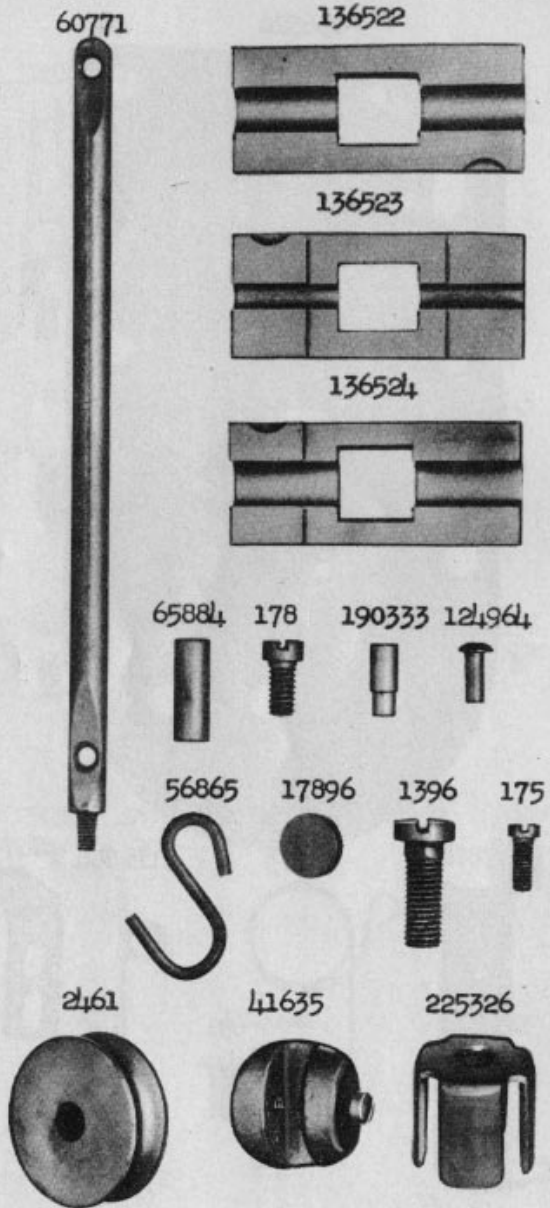

PLATE 9570 - ONE-HALF SIZE

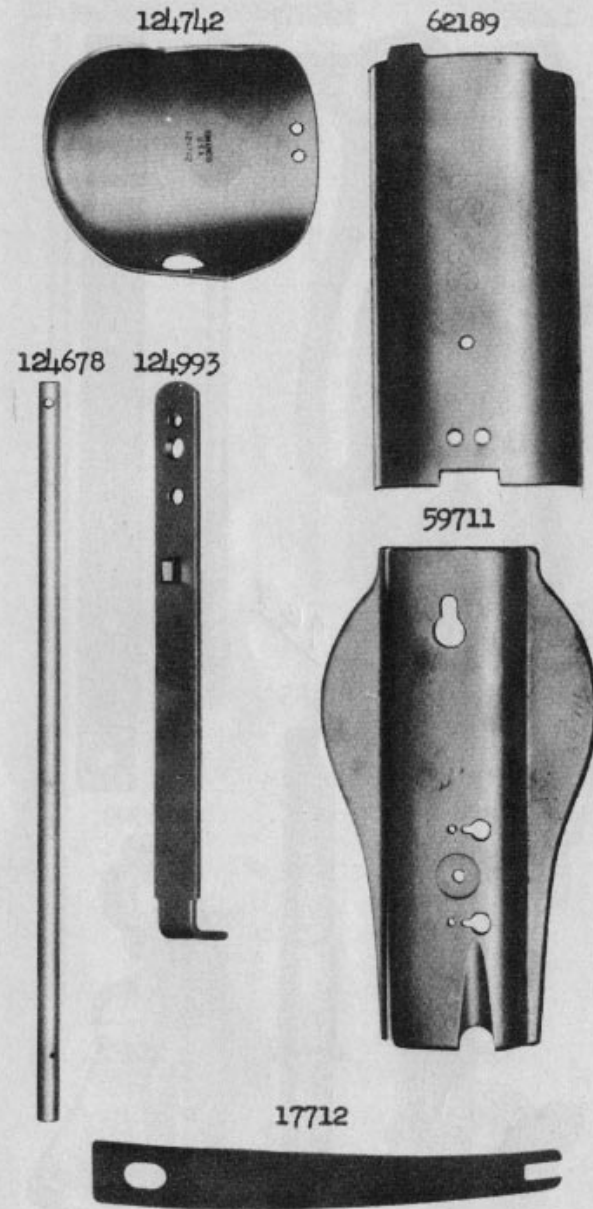

PLATE 9571 - ONE-HALF SIZE

124999



124847



18445



136508

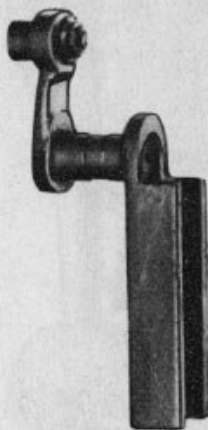

62155



1908

136509

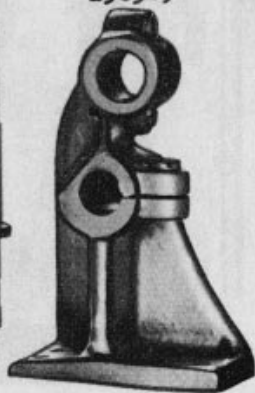

PLATE 9572 - ONE-HALF SIZE

124763



62299



2058



17845



136504

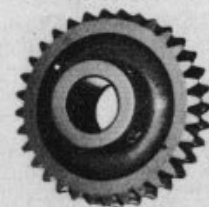

136503



62235

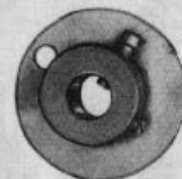

59734



124839



59747



136506

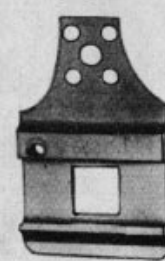
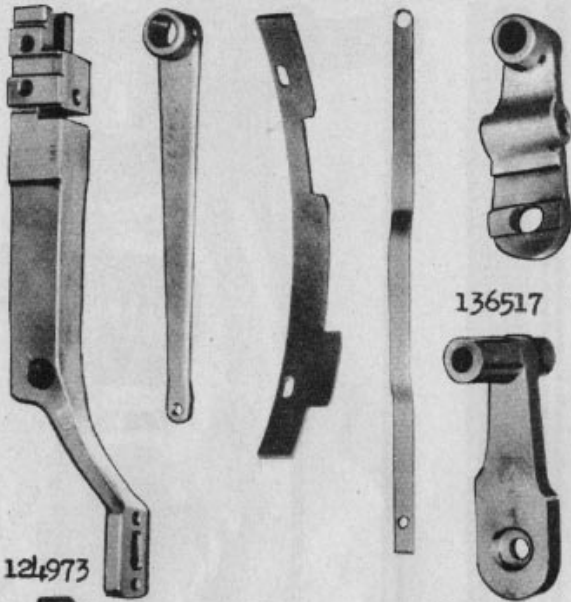

PLATE 9573 - ONE-HALF SIZE

124784 124620 136514 124653 124957



136517



124973



136518



124772

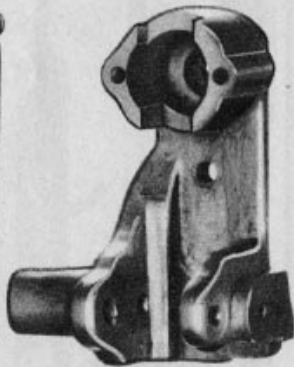

39222



PLATE 9574 - ONE-HALF SIZE

39219 63973 63974 124674 17881

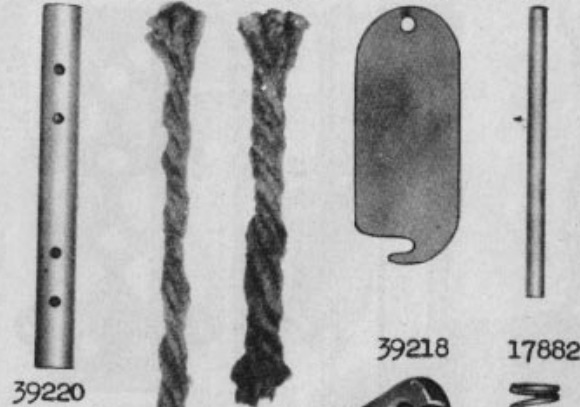

39220



39218



17882



65883

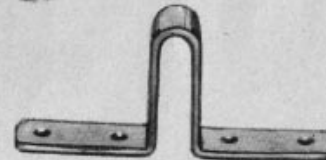

17893

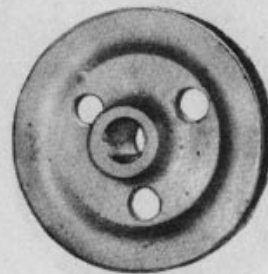

59795

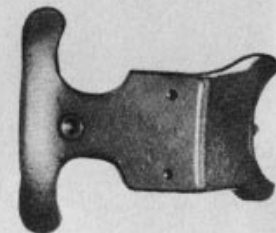
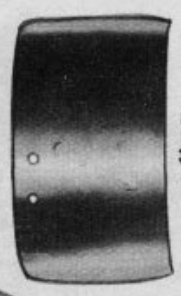
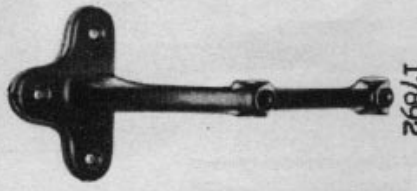
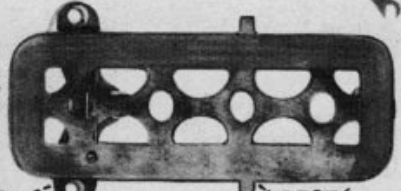
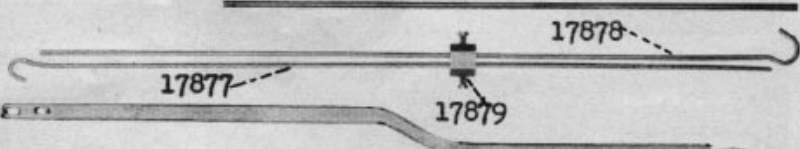
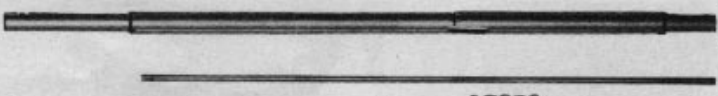

PLATE 9575 - ONE-FOURTH SIZE

121790 59702 121767 17880 62121 17881



18198

136502

17883

17876

17878

17877

17879

17892

121767

PLATE 9576 - ONE-HALF SIZE

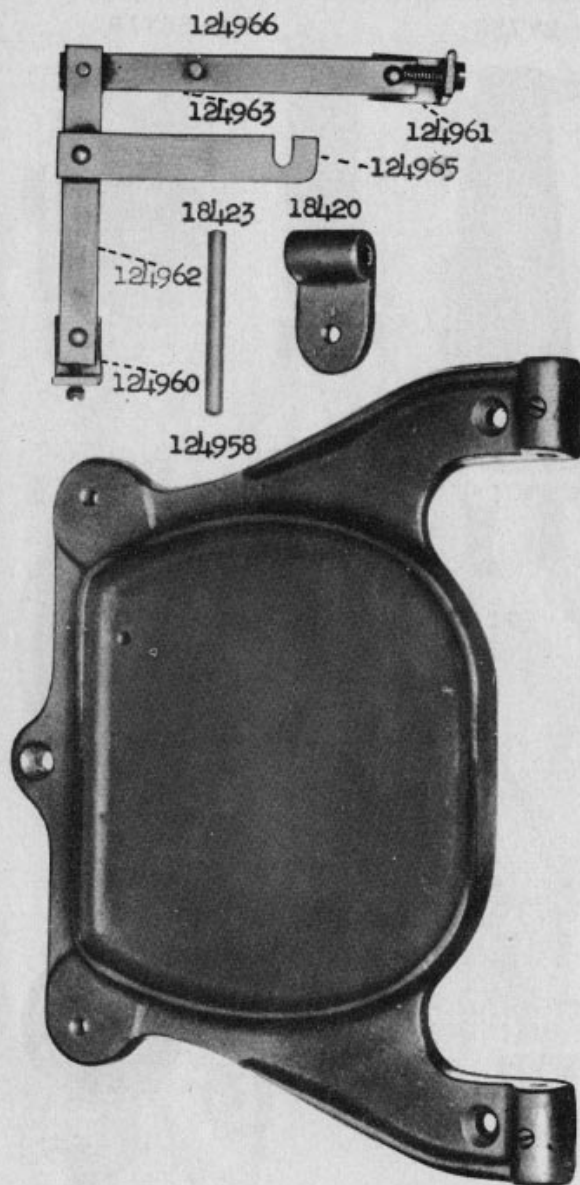
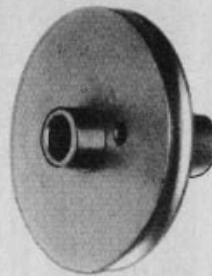

PLATE 20337-ONE-HALF SIZE

27739



68716



68712

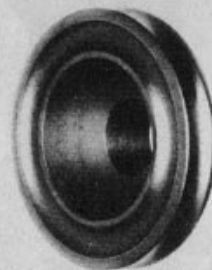

225390

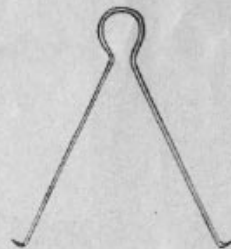

68714

