

Form 18421  
February, 1930  
PRINTED IN U. S. A.

# LIST OF PARTS

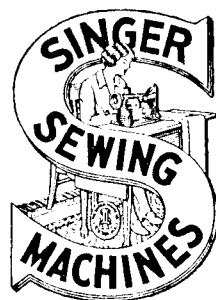

**MACHINE No. 147-35**

---

**THE SINGER MANUFACTURING COMPANY**

COPYRIGHT, U. S. A., 1925, 1927, 1928 AND 1930  
BY THE SINGER MANUFACTURING CO.  
ALL RIGHTS RESERVED FOR ALL COUNTRIES

## INDEX

---

	PAGE
ACCESSORIES .....	17
BELT GUARD .....	17
BENCH STAND .....	17
FOOT LIFTER PARTS .....	18
KNEE LIFTER PARTS .....	18
MACHINE BASE .....	18
MACHINE NO. 147-35 .....	7
NUMERICAL LIST OF PARTS .....	21
OBSOLETE PARTS .....	20
TAPE HOLDER (5 IN. DIAM.) .....	19
THREAD UNWINDER .....	19

## INSTRUCTIONS FOR ORDERING

In ordering from this list, use **ONLY** the part NUMBER in the **FIRST** column.

The number stamped on a Sewing Machine part is in every case the number of the single part only.

Every combination of parts sent out as such has its specific number, which, although not stamped on the parts, must be used when ordering the combination.

Each number always indicates the **SAME PART** in whatever list it appears, or for whatever machine.

The letters after some of the numbers indicate the style of finish only, as follows:

- A—Hardened, Polished, Nickel Plated and Buffed
- B—Polished, Nickel Plated and Buffed
- C—Hardened Only
- D—Polished Only
- E—Soft, Not Polished
- F—Hardened and Polished
- H—Blued
- J—Nickel Plated Only
- K—Hardened and Nickel Plated
- L—Brass Plated
- M—Oxidized
- N—Japanned, Dull
- P—Japanned, Bright
- R—Merlized
- T—Copper Plated
- T. A.—Hardened, Polished, Copper and Nickel Plated and Buffed
- T. B.—Copper and Nickel Plated and Polished
- T. J.—Copper and Nickel Plated Only
- T. K.—Hardened, Copper and Nickel Plated
- T. M.—Copper Plated and Oxidized
- T. L.—Copper and Brass Plated
- U—Zinc Plated
- V—Silver Plated
- W—Polished and Nickel Plated
- Z—Chromium Plated
- Z. B.—Polished, Nickel Plated, Buffed and Chromium Plated
- Z. J.—Nickel and Chromium Plated

These letters **MUST BE USED** when they appear in the list; and **AFTER** the number **as** in the list.

In this series:

- 1 to 1500 and 50001 to 51500 are Screw Numbers
- 1501 to 1800 and 51501 to 51800 are Nut Numbers
- 1801 to 2000 and 51801 to 52000 are Roller Numbers
- 2001 to 50000 and 52001 and upward are numbers of Machine Parts

The figures in the second column refer only to the plates, illustrating the parts, and are **NOT TO BE USED** in ordering.

Parts marked with an asterisk (\*) are furnished only when repairs are made at factory.

When ordering parts which differ as to **Gauge** (the distance between seams) the Gauge, as well as the **Number must be given** on order.

## LIST OF PARTS COMPLETE

FOR

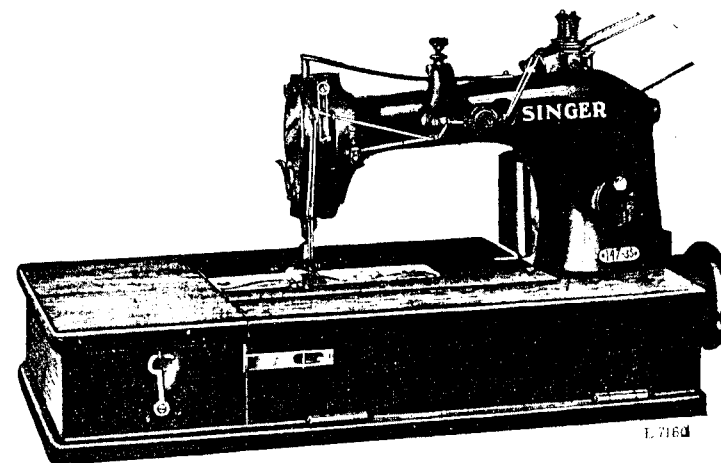

## MACHINE No. 147-35

**FOR STAYING SHOES. TWO NEEDLES, TWO LOOPERS. TWO  
THREAD CHAIN STITCH. GAUGES  $\frac{3}{8}$  IN. TO  $\frac{3}{8}$  IN.  
THREAD NIPPING DEVICE. FOOT LIFTER. SPEED UP TO  
3500 ACCORDING TO THE MATERIAL BEING STITCHED.**

NO.	PLATE	NAME
*54182	---	Arm, upper and lower (solid) with 948s and 54034.....
42366	8901	Arm Oil Pad (braided cotton) for oiling Arm Rock Shaft Front Bearing.....
56006	8901	Arm Oil Pad (braided cotton) for oiling Arm Rock Shaft Intermediate Bearing
56003	8985	Arm Oil Tube with 52045 for oiling 54326
52045	8901	" " " Packing (braided cotton) ..
54183	8938	" Rock Shaft.....
54192	---	" " " 54183 with 46383, 54004, 54184 and 64255.....
64386	8901	Arm Rock Shaft Bushing (back).....
446c	8901	" " " " " Set Screw
64388	8901	" " " " (intermediate)
423c	8901	" " " " "
		Set Screw.....

NO.	PLATE	NAME
52045	8901	Arm Rock Shaft Bushing Oil Pad (braided cotton).....
54004	8901	Arm Rock Shaft Collar with two 453c....
453c	8901	“ “ “ “ Set Screw.....
54184	8985	“ “ “ Crank (back) with two 50083c.....
50083c	8901	Arm Rock Shaft Crank (back) Set Screw
64255	9882	“ “ “ “ (front) with 453c
2117	8901	“ “ “ “ “ Pin.....
453c	8901	“ “ “ “ “ Set Screw
54105	8901	“ “ “ Flanged Bushing (front)
453c	8901	“ “ “ “ “ “
		Set Screw.....
52045	8901	Arm Rock Shaft Flanged Bushing (front) Oil Pad (braided cotton).....
*54006	8938	Arm Rotary Shaft.....
NOTE: When No. 54006 is required for repairs, the Looper Driving Shaft and Feed Lifting Eccentric must be returned to the factory to be adjusted to the new part.		
54448	—	Arm Rotary Shaft 54006 with 640b, 54008, 54088, 54113, 54447, 64351 and 64355.
54081	8901	Arm Rotary Shaft Bushing (front).....
52045	8901	“ “ “ “ “ Oil Pad (braided cotton).....
761E	8901	Arm Rotary Shaft Bushing (front) Set Screw.....
54007	8902	Arm Rotary Shaft Bushing (intermediate)
54089	—	“ “ “ “ “ “
		54007 with 64508 and 64805.....
64508	8902	Arm Rotary Shaft Bushing (intermediate) Oil Pad, long (braided cotton).....
64805	8985	Arm Rotary Shaft Bushing (intermediate) Oil Pad, short (braided cotton).....
422c	8901	Arm Rotary Shaft Bushing (intermediate) Set Screw (long).....
50084c	8901	Arm Rotary Shaft Bushing (intermediate) Set Screw (short).....
54008	8901	Arm Rotary Shaft Collar with three 1259c
1259c	8958	“ “ “ “ Set Screw.....
54009	8902	“ “ “ Flanged Bushing.....
54090	—	“ “ “ “ “ 54009 with 58039 and 64805.....
58039	8902	Arm Rotary Shaft Flanged Bushing Oil Pad, long (braided cotton).....
64805	8985	Arm Rotary Shaft Flanged Bushing Oil Pad, short (braided cotton).....

NO.	PLATE	NAME
159F	8901	Arm Rotary Shaft Flanged Bushing Screw
49013	8904	“ “ “ Front Bearing Oil Pad (braided cotton).....
144D	8901	Arm Rotary Shaft Screw.....
15196	8902	“ Side Cover (back).....
286D	8904	“ “ “ “ Thumb Screw....
54010	8904	“ “ “ (front).....
286D	8904	“ “ “ “ Thumb Screw....
54210	9889	Balance Wheel, 2 $\frac{3}{8}$ in. pulley with two 430c.....
430c	8904	Balance Wheel Set Screw.....
54199	8938	Cloth Plate.....
54012	8902	“ “ Slide (left).....
38419	8904	“ “ “ “ Spring.....
725J	8904	“ “ “ “ “ Screw....
54013	—	Cloth Plate Slide (left) complete, Nos. 38419, 54012 and two 725J.....
54055	9889	Cloth Plate Slide (right) for 54056.....
68191	—	“ “ “ “ “ 68192.....
38419	8904	“ “ “ “ Spring.....
725J	8904	“ “ “ “ “ Screw..
54056	—	Cloth Plate Slide (right) complete for 54200, Nos. 38419, 54055 and two 725J
54200	—	Cloth Plate complete, for $\frac{3}{8}$ in. to $\frac{3}{16}$ in. gauges, for 68014, Nos. 54013, 54056 and 54199.....
68268	—	Cloth Plate complete, for $\frac{3}{8}$ in. to $\frac{3}{16}$ in. gauges, for 54338, Nos. 54013, 54199 and 68192.....
1011F	8904	Cloth Plate Screw (left).....
50473F	8904	“ “ “ (right).....
54104	8938	“ “ Thread Guard.....
1235D	8904	“ “ “ “ Screw.....
54017	8902	Crank Connecting Rod with 6575, 54018, 54218, 54897, 57222 and two each 896E and 1057E.....
54088	—	Crank Connecting Rod 54017 with 50069c
50069c	8904	“ “ “ Ball Screw Stud
1516E	8904	“ “ “ “ “ “
		Nut.....
64268	8904	Crank Connecting Rod Ball Screw Stud Washer.....
*57222	—	Crank Connecting Rod Cap (lower).....
896E	8904	“ “ “ “ “ Screw
*54018	—	“ “ “ “ “ (upper).....
1057E	8904	“ “ “ “ “ Screw
54897	8904	“ “ “ “ Oil Cup.....

NO.	PLATE	NAME
54218	8904	Crank Connecting Rod Oil Pad (braided cotton).....
6575	8904	Crank Connecting Rod Oil Pad Stop Pin
64269	9889	Face Plate.....
46111	9888	" " Pin.....
286D	8904	" " Thumb Screw.....
54019	8902	Feed Bar with 50429c and two 453c.....
54020	8902	" " Connection.....
57225	8904	" " Hinge Pin.....
453c	8901	" " " " Set Screw.....
54111	8902	" Connecting Rod with 1057E, 54112 and two 896E.....
54113	---	Feed Connecting Rod 54111 with 54025..
*54112	---	" " " Cap.....
896E	8904	" " " " Screw.....
1057E	8904	" " " Clamping Screw...
54023	9882	" " " Hinge Pin.....
21506	8904	" " " " Collar with 457c.....
457c	8904	Feed Connecting Rod Hinge Pin Collar Set Screw.....
68011	9881	Feed Dog, 16 teeth (16 teeth to the inch) for 68014.....
54337	9881	Feed Dog, 17 teeth (16 teeth to the inch) for 54338.....
NOTE: When ordering Nos. 54337 or 68011 state gauge required.		
157w	8904	Feed Dog Screw.....
50429c	8904	" " Stop Screw.....
*54024	---	Feed Eccentric.....
*23729	---	" " Body.....
51061c	8958	" " " Set Screw.....
7071	8904	" " Clamping Washer.....
217D	8904	" " " " Screw...
54025	8985	Feed Eccentric (adjustable) complete, Nos. 217D, 1103c, 7071, 23729, 54024 and two 51061c.....
1103c	8904	Feed Regulating Screw.....
54026	9873	" Rocking Frame with two 453c.....
54077	---	" " " 54026 with 21506, 54019, 54020, 54023 and 57225.....
57234	9882	Feed Rocking Frame Hinge Pin.....
57235	8985	" " " " " Bushing
453c	8901	" " " " " " Set Screw.....
453c	8901	Feed Rocking Frame Hinge Pin Set Screw

NO.	PLATE	NAME
54106	9883	Looper (back) closed eye.....
NOTE: When ordering No. 54106, state gauge of machine for which required.		
1147c	9883	Looper (back) Set Screw.....
54107	9883	Looper (front) closed eye.....
NOTE: When ordering No. 54107, state gauge of machine for which required.		
1120c	8958	Looper (front) Set Screw.....
54027	9883	" Carrier with two 171D.....
171D	8958	" " Adjusting Screw.....
54227	9883	" " Connection.....
54228	9883	" " " Shaft.....
54229	9883	" " " " Bushing
446c	8901	" " " " " " Set Screw.....
49013	8904	Looper Carrier Connection Shaft Oil Pad (braided cotton).....
54230	9883	Looper Carrier Driver with 54032 and four 175E.....
*54032	---	Looper Carrier Driver Cap.....
175E	8958	" " " " " Screw.....
*54440	8990	" Driving Shaft and Feed Lifting Eccentric with 227D and two 64315....
NOTE: When No. 54440 is required for repairs, the Arm Rotary Shaft must be returned to the factory to be adjusted to the new part.		
54447	---	Looper Driving Shaft and Feed Lifting Eccentric 54440 with 54027, 54227, 54228 and 54230.....
*54034	---	Looper Driving Shaft and Feed Lifting Eccentric Bracket with 761E.....
54080	8990	Looper Driving Shaft and Feed Lifting Eccentric Bracket Bushing.....
761E	8901	Looper Driving Shaft and Feed Lifting Eccentric Bracket Bushing Set Screw
948D	8958	Looper Driving Shaft and Feed Lifting Eccentric Bracket Screw.....
64315	8990	Looper Driving Shaft and Feed Lifting Eccentric Oil Hole Plug.....
227D	8958	Looper Driving Shaft and Feed Lifting Eccentric Oil Hole Screw.....
40326	8990	Looper Driving Shaft and Feed Lifting Eccentric Oil Pad (braided cotton)....
640D	8958	Looper Driving Shaft and Feed Lifting Eccentric Screw.....

NO.	PLATE	NAME
54061	8990	Looper Holder with 1120c and 1147c....
704w	8958	" " Screw.....
64319	9884	Needle Bar (hollow).....
51062	---	Needle Bar complete, for $\frac{3}{32}$ in. to $\frac{1}{4}$ in. gauges, Nos. 54064, 54065 and 64319..
51063	---	Needle Bar complete, for $\frac{3}{32}$ in. to $\frac{3}{8}$ in. gauges, Nos. 54064, 54066 and 64319..
38456	9882	Needle Bar Bushing (lower).....
1133e	8958	" " " " Set Screw...
64320	9882	" " " (upper).....
1133e	8958	" " " " Set Screw...
54326	9882	" " Connecting Link.....
51329	---	" " " " 54326 with 51327 and 51328.....
51327	9882	Needle Bar Connecting Link Hinge Stud
1520j	9888	" " " " " " "
		Nut.....
54328	9882	Needle Bar Connecting Stud with 241f and two 187e.....
187e	8958	Needle Bar Connecting Stud Clamping Screw.....
54064	9884	Needle Clamp with two 1498e.....
54065	9884	" " Thread Guard, for $\frac{3}{32}$ in. to $\frac{1}{4}$ in. gauges.....
54066	9884	Needle Clamp Thread Guard, for $\frac{3}{32}$ in. to $\frac{3}{8}$ in. gauges.....
54067	9884	Needle Guard for $\frac{1}{32}$ in. to $\frac{5}{32}$ in. gauges.
54068	9884	" " " $\frac{3}{16}$ in. to $\frac{9}{32}$ in. gauges.
54069	9884	" " " $\frac{5}{16}$ in. to $\frac{3}{8}$ in. gauges.
54038	9884	" Guard Holder.....
176d	8958	" " " Screw.....
217f	8901	" " " Screw.....
1498f	8958	" " " Set Screw.....
64330	9873	Presser Bar with 25303.....
25303	8990	" " Ball, size $\frac{1}{4}$ in.....
64331	9882	" " Bushing (lower).....
1133e	8958	" " " " Set Screw...
38456	9882	" " " (upper).....
1133e	8958	" " " " Set Screw...
54039	8985	" " Guide Bracket with 453c, 640w and 1963.....
610w	8958	Presser Bar Guide Bracket Adjusting Screw.....
11173	8985	Presser Bar Guide Bracket Guide....
447c	8958	" " " " " " Set Screw.....

NO.	PLATE	NAME
1963	8985	Presser Bar Guide Bracket Roller and Stud.....
453c	8901	Presser Bar Guide Bracket Set Screw....
57257	9882	" " Lifter.....
57258	9882	" " " Hinge Pin.....
447c	8958	" " " " " Set Screw...
1872	8985	" " " Roller and Stud.....
1250c	9884	" " " Stop Screw.....
61047	9884	" " Lifting Bracket with 460c and 1872.....
68208	9873	Presser Bar Lifting Lever.....
61075	9884	" " " " Connecting Stud
460c	9888	" " " " " " "
		Set Screw.....
68184	9873	Presser Bar Lifting Lever Extension.....
161d	8958	" " " " " " Screw
802d	8958	" " " " Hinge Screw...
54040	9873	" " Spring (flat).....
38468	8990	" " " Stud.....
68012	9881	" Foot Needle Guard.....
906c	9881	" " " " Adjusting Screw.....
240w	9881	Presser Foot Needle Guard Screw.....
68013	9881	" " with 240w, 68012 and two 906c, for $\frac{3}{32}$ in. to $\frac{3}{16}$ in. gauges.....
		NOTE: When ordering No. 68013 state gauge required.
26276	9881	Presser Foot Hinge Pin.....
68244	9881	" " Needle Guard.....
337w	9881	" " " " Screw.....
68245	---	" " Plate.....
46087	---	" " Shank.....
68246	9881	Presser Foot (hinged) complete, for $\frac{7}{32}$ in. to $\frac{3}{8}$ in. gauges, Nos. 26276, 46087, 68245 and two each 337w and 68244...
		NOTE: When ordering No. 68246, state gauge required.
190d	8958	Presser Foot Screw.....
574w	8958	Pressure Regulating Thumb Screw.....
1539w	9888	" " " " " Lock Nut.....
54381	9884	Slack Thread Controller.....
54242	8990	Slack Thread Controller Clamp.....
190d	8958	" " " " Screw...
64337	9884	" " Regulator.....
54042	8990	" " " Holder with 175e and two 50150c.....

NO.	PLATE	NAME
175e	8958	Slack Thread Regulator Holder Clamping Screw.....
54043	8990	Slack Thread Regulator Holder Shaft
24292	8990	“ “ “ “ “
		Collar with 1019c.....
1019c	8958	Slack Thread Regulator Holder Shaft
		Collar Set Screw.....
54044	8990	Slack Thread Regulator Holder Shaft
		Crank (forked) with 1253c.....
1253c	8958	Slack Thread Regulator Holder Shaft
		Crank Set Screw.....
50150c	8958	Slack Thread Regulator Set Screw.....
35717	9888	Stay Guide (lower).....
35718	9888	“ “ (upper).....
35719	—	Stay Guide complete, Nos. 35717 and 35718.....
1499d	9888	Stay Guide Screw.....
2102	9885	Tension (under thread) Disc.....
51570c	9885	“ “ “ “ Regulating Thumb Nut.....
32572	9885	Tension (under thread) Releasing Disc...
50326c	9885	“ “ “ “ Screw Stud.....
59539	—	“ “ “ “ “ 50326c with 51570c.....
59534	9885	Tension (under thread) Spring.....
59537	9885	“ “ “ “ Bushing (large).....
59538	9885	Tension (under thread) Spring Bushing (small).....
17547	9885	Tension (under thread) Thread Guide...
54216	9886	“ (upper thread, automatic) Body
1508j	9886	“ “ “ “ “ Nut.....
54333	9886	Tension (upper thread, automatic) Body Releasing Pin.....
46383	9886	Tension (upper thread, automatic) Cam with two 1253c.....
1253c	8958	Tension (upper thread, automatic) Cam Set Screw.....
2102	9885	Tension (upper thread, automatic) Disc..
1560c	9885	“ “ “ “ “ Regu- lating Thumb Nut.....
32572	9885	Tension (upper thread, automatic) Releas- ing Disc.....
50106c	9885	Tension (upper thread, automatic) Screw Stud.....

NO.	PLATE	NAME
53213	—	Tension (upper thread, automatic) Screw Stud 50106c with 1560c.....
46385	9885	Tension (upper thread, automatic) Screw Stud Releasing Pin.....
46387	9885	Tension (upper thread, automatic) Spring
54244	9886	“ “ “ “ Thread Guide.....
54070	8996	Tension (upper thread) Bracket.....
376d	8958	“ “ “ “ Screw...
2102	9885	“ “ “ “ Disc.....
51570c	9885	“ “ “ “ Regulating Thumb Nut.....
32572	9885	Tension (upper thread) Releasing Disc...
54988	9885	“ “ “ “ Pin....
54071	9889	“ “ “ “ Shaft
54047	9886	“ “ “ “ “ Crank with 624c.....
54048	9886	Tension (upper thread) Releasing Shaft Crank Link.....
624c	8958	Tension (upper thread) Releasing Shaft Crank Set Screw.....
54990	9886	Tension (upper thread) Releasing Shaft Spring.....
316f	8958	Tension (upper thread) Releasing Shaft Stop Screw.....
1547j	9885	Tension (upper thread) Releasing Shaft Stop Screw Nut.....
50326c	9885	Tension (upper thread) Screw Stud.....
59539	—	“ “ “ “ “ 50326c with 51570c.....
59535	9885	Tension (upper thread) Spring.....
59537	9885	“ “ “ “ Bushing (large).....
59538	9885	Tension (upper thread) Spring Bushing (small).....
57076	9885	Tension (upper thread) Thread Guide (double).....
68234	9887	Thread Oil Cup.....
68235	9887	“ “ “ “ Cover.....
54515	9887	“ “ “ “ Hinge Pin.....
68236	9887	“ “ “ “ Latch Spring
50411d	9887	“ “ “ “ “ Screw.....
68237	9887	Thread Oil Cup Cover Oil Pad (felt)....
665d	9887	“ “ “ “ “ Screw....
68238	9887	“ “ “ “ Oil Pad (felt) for Cup...
49092	9887	“ “ “ “ “ “ Tube..

NO.	PLATE	NAME
68239	9887	Thread Oil Cup and Oil Tube complete, for oiling upper thread and crank connecting rod (upper bearing), Nos. 49092, 50411b, 54515, 68234 to 68238 and two 665d.....
53225	9886	Thread (under) Eyelet (back).....
190b	8958	" " " " Screw.....
54072	9886	" " " (front).....
64351	9886	" " Nipper Cam with 465c..
465c	8958	" " " " Set Screw..
38210	9885	" " " Spring (lower)...
38211	9885	" " " " (upper)
46247	9885	" " " " "
		Stop.....
176d	8958	Thread (under) Nipper Spring Screw....
38475	9886	" " Take-up with 465c.....
465c	8958	" " " Set Screw.....
54435	9886	" " " Staple with 5900 and 38481.....
54049	9873	Thread (under) Take-up Staple Bracket with 460c.....
965d	9888	Thread (under) Take-up Staple Bracket Screw.....
46041	9885	Thread (under) Take-up Staple Spring
190d	8958	" " " " " " Screw.....
38481	9886	Thread (under) Take-up Staple Thread Guard.....
590d	8958	Thread (under) Take-up Staple Thread Guard Screw.....
38482	9885	Thread (under) Take-up Stripper.....
207d	9888	" " " " Screw.
64355	9886	" " " Thread Guard (brass).....
64356	9886	Thread (under) Take-up Thread Guard Steady Pin.....
460c	9888	Thread (under) Take-up Thread Guard Steady Pin Set Screw.....
54330	9886	Thread (upper) Controller.....
207d	9888	" " " Screw.....
46009	9886	" " Eyelet.....
190d	8958	" " " Screw.....
54094	9888	" " Take-up.....
54095	9888	" " " Plate.....
68164	9888	" " " " Spring
1449d	9888	" " " " " Screw.....

NO.	PLATE	NAME
54096	—	Thread (upper) Take-up complete, Nos. 1449b, 54094, 54095 and 68164.....
211f	8958	Thread (upper) Take-up Set Screw.....
68014	9881	Throat Plate, for $\frac{3}{32}$ in. to $\frac{3}{16}$ in. gauges, for 68011.....
54338	9881	Throat Plate, for $\frac{1}{32}$ in. to $\frac{3}{8}$ in. gauges, for 54337.....
NOTE: When ordering 54338 or 68014, state gauge required.		
742f	9884	Throat Plate Screw.....

## ACCESSORIES

NO.	PLATE	NAME
120344	8941	Oiler (copper plated) with 120345.....
120345	8941	" Spout, 5 in. long.....
26026	8941	Screw Driver (large).....
26485	8941	" " (small).....
38487	8941	Threading Wire.....
120341	8941	Tweezers (curved).....
8908	8941	Wrench for 1520.....
19221	8941	" " 1516.....
4822	8941	" " 1547.....

## BELT GUARD

NO.	PLATE	NAME
68222	9879	Belt Guard with two wood screws 1 in. No. 12.....

## BENCH STAND

NO.	PLATE	NAME
79611	—	Bench Stand with 5604, 9370, two 41538, three wood screws $1\frac{1}{4}$ in. No. 14, four 60656 and sixteen wood screws $\frac{5}{8}$ in. No. 7.....
41538	—	Flush Bolt with Plate complete, Nos. 126247, 126248 and four brass wood screws $\frac{5}{8}$ in. No. 4.....
126247	8952	Flush Bolt.....
126248	8952	" " Plate.....
60656	8952	Hinge.....
9370	8952	Slide Spring.....
5604	8952	" " Pin.....



## FOOT LIFTER PARTS

NO.	PLATE	NAME
6439	-----	Chain, 36 in. to 45 in., with 56864 and 56865.....
NOTE: When ordering No. 6439, state length required.		
4879	8941	Chain Connecting Link.....
56864	8941	" Hook (large).....
56865	8985	" " (small).....
126249	8980	Treadle.....
4882	8941	" Shaft.....
126250	8941	" Spring.....
126251	8980	" Stand.....
126252	8980	Treadle complete, Nos. 4882, 126249 to 126251 and two wood screws 1 in. No. 16

## KNEE LIFTER PARTS

NO.	PLATE	NAME
37563	----	Chain, length 15 in., with 56864 and 56865
56864	8941	" Hook (large).....
56865	8985	" " (small).....
2763	8980	Rock Shaft.....
12242	8980	" " Hanger with two wood screws 1 in. No. 10.....
6335	8980	Rock Shaft Knee Arm.....
6336	---	Rock Shaft Knee Arm complete, Nos. 2766, 2767 and 6335.....
2766	8980	Rock Shaft Knee Arm Hub with 356c....
356c	8985	" " " " " Set Screw....
2767	8980	" " " " " Plate with 356c.....
356c	8985	" " " " " Set Screw.....
6337	8980	" " " " " Lifting Bracket with two 356c
7125	8980	" " " " " H o o k.....
356c	8985	" " " " " S e t Screw.....
356c	8985	Rock Shaft Lifting Bracket Set Screw....
2770	8980	" " " " " Stop Dog with 356c.....
356c	8985	" " " " " Set Screw.....
23767	8980	Rock Shaft complete, Nos. 2763, 2770, 6336, 6337, 7125 and two 12242.....

## MACHINE BASE

NO.	PLATE	NAME
68223	9879	Machine Base.....
51072E	9888	" " Bolt with 51581E.....

## MACHINE BASE

NO.	PLATE	NAME
51581E	9888	Machine Base Bolt Nut.....
6055	8990	" " " " Washer.....
49123	8996	" " Oil Pipe.....
60884	8985	" " " Plug.....
57285	8996	" Cushion (felt).....
948E	8958	" Screw, to fasten machine to base
68224	----	Machine Base complete, Nos. 49123, 60884, 68223, three each 6055, 51072E and four each 948E and 57285.....

## TAPE HOLDER (5 In. Diam.)

### FOR UNDER THE BENCH

NO.	PLATE	NAME
36795	8938	Tape Holder Body.....
36796	8938	" " Cover.....
55D	9884	" " " Hinge Screw.....
28994	8938	Tape Holder (5 in. diam.) complete, Nos. 55D, 36795, 36796 and two wood screws 1 1/4 in. No. 10.....

## THREAD UNWINDER

### FOR FOUR SPOOLS

NO.	PLATE	NAME
225395	8953	Spool Rest (for two spools) with 201018c
225388	8953	" " Rod.....
200383c	8985	" " " Set Screw.....
201018c	8985	" " " Set Screw.....
202490	8953	" " Stand with 200383c.....
225391	8953	Thread Guide.....
201696J	9888	" " Lock Nut.....
225392	8953	" " Rod with 208E and 225393
208E	8985	" " " Screw.....
225393	9888	" " " Washer.....
225398	8953	Thread Unwinder complete, Nos. 201696J, 202490, 225388, 225392, two 225395, four 225391 and three wood screws 1/2 in. No. 12.....
27739	8996	Thread Cone (wood) for large cones....
225390	8996	" " Holder, for inverted cones..

NOTE: Nos. 27739 and 225390 are used with, but not included in 225398

## OBSOLETE PARTS

NO.	PLATE	NAME
54356	8980	Belt Guard with 1192c.....
27347	8985	“ “ Hinge Pin.....
1192c	8985	“ “ “ “ Set Screw.....
1192c	8985	“ “ Set Screw.....
54357	8980	Machine Base with 1192c.....
54358	—	Machine Base with Belt Guard complete, Nos. 27347, 49123, 54356, 54357, 60884, three each 6055, 51072e and four each 948e and 57285.....
54188	9888	Oil Cup.....
1284b	9888	“ “ Regulating Screw.....
2026	9888	“ “ “ “ Spring.....
38100	9888	“ “ Packing (felt).....
54189	—	Oil Cup complete, for oiling upper thread, Nos. 1284b, 2026, 38100 and 54188, use 68239.....
1423w	9888	Oil Cup Screw.....
54108	—	“ Tube.....
54109	—	“ “ Bracket.....
49092	8990	“ “ Packing (felt).....
54110	8990	Oil Tube complete, for oiling crank con- necting rod (upper bearing), Nos. 49092, 54108 and 54109.....
64362	8996	Presser Bar Lifting Lever.....
54103	9873	“ “ “ “ Extension....

<p style="text-align: center;"><b>Genuine Singer Needles and their Con- tainers are marked with the Company's Trade Mark "SIMANCO." 1</b></p>
---

<p style="text-align: center;"><b>Needles in Containers marked "For Singer Machines" are <u>not</u> Singer made needles. 2</b></p>
--

**NUMERICAL LIST OF PARTS**  
**FOR**  
**MACHINE No. 147-35**

**NUMERICAL LIST OF PARTS**

NO. PLATE	NAME
55D 9884	Tape Holder Cover Hinge Screw for 28994
144D 8901	Arm Rotary Shaft Screw.....
157W 8904	Feed Dog Screw.....
159F 8901	Arm Rotary Shaft Flanged Bushing Screw
161D 8958	Presser Bar Lifting Lever Extension Screw
171D 8958	Looper Carrier Adjusting Screw for 54027
175E 8958	“ “ Driver Cap Screw for 54230
175E 8958	Slack Thread Regulator Holder Clamping Screw for 54042.....
176D 8958	Needle Guard Holder Screw.....
176D 8958	Thread (under) Nipper Spring Screw....
187E 8958	Needle Bar Connecting Stud Clamping Screw for 54328.....
190D 8958	Presser Foot Screw.....
190D 8958	Slack Thread Controller Clamp Screw....
190D 8958	Thread (under) Eyelet (back) Screw....
190D 8958	“ “ Take-up Staple Spring Screw.....
190D 8958	Thread (upper) Eyelet Screw.....
207D 9888	“ (under) Take-up Stripper Screw..
207D 9888	“ (upper) Controller Screw.....
208E 8985	“ Unwinder Thread Guide Rod Screw for 225392.....
211F 8958	Thread (upper) Take-up Set Screw for 54328.....
217D 8904	Feed Eccentric Clamping Washer Screw for 54025.....
217F 8904	Needle Guard Screw.....
227D 8958	Looper Driving Shaft and Feed Lifting Eccentric Oil Hole Screw for 54440....
240W 9881	Presser Foot Needle Guard Screw for 68013.....
286D 8904	Arm Side Cover (back) Thumb Screw....
286D 8904	“ “ “ (front) Thumb Screw....
286D 8904	Face Plate Thumb Screw.....
316F 8958	Tension (upper thread) Releasing Shaft Stop Screw.....
337W 9881	Presser Foot Needle Guard Screw for 68246.....
356C 8985	Rock Shaft Knee Arm Hub Set Screw for 2766.....
356C 8985	Rock Shaft Knee Plate Set Screw for 2767
356C 8985	“ “ Lifting Bracket Hook Set Screw for 6337.....

NO. PLATE	NAME
356c 8985	Rock Shaft Lifting Bracket Set Screw for 6337.....
356c 8985	Rock Shaft Stop Dog Set Screw for 2770.....
376d 8958	Tension (upper thread) Bracket Screw.....
422c 8901	Arm Rotary Shaft Bushing (intermediate) Set Screw (long).....
423c 8901	Arm Rock Shaft Bushing (intermediate) Set Screw.....
430c 8904	Balance Wheel Set Screw for 54210.....
446c 8901	Arm Rock Shaft Bushing (back) Set Screw.....
446c 8901	Looper Carrier Connecting Shaft Bushing Set Screw.....
447c 8958	Presser Bar Guide Bracket Guide Set Screw.....
447c 8958	Presser Bar Lifter Hinge Pin Set Screw.....
453c 8901	Arm Rock Shaft Collar Set Screw for 51004.....
453c 8901	Arm Rock Shaft Crank (front) Set Screw for 61255.....
453c 8901	Arm Rock Shaft Flanged Bushing (front) Set Screw.....
453c 8901	Feed Bar Hinge Pin Set Screw for 54019.....
453c 8901	" Rocking Frame Hinge Pin Bushing Set Screw.....
453c 8901	Feed Rocking Frame Hinge Pin Set Screw for 54026.....
453c 8901	Presser Bar Guide Bracket Set Screw for 54039.....
457c 8904	Feed Connecting Rod Hinge Pin Collar Set Screw for 21506.....
460c 9888	Presser Bar Lifting Lever Connecting Stud Set Screw for 61047.....
460c 9888	Thread (under) Take-up Thread Guard Steady Pin Set Screw for 54049.....
465c 8958	Thread (under) Nipper Cam Set Screw for 64351.....
465c 8958	Thread (under) Take-up Set Screw for 38475.....
574w 8958	Pressure Regulating Thumb Screw.....
590d 8958	Thread (under) Take-up Staple Thread Guard Screw for 54435.....
624c 8958	Tension (upper thread) Releasing Shaft Crank Set Screw for 54047.....
640d 8958	Looper Driving Shaft and Feed Lifting Eccentric Screw for 54448.....
640w 8958	Presser Bar Guide Bracket Adjusting Screw for 54039.....

NO. PLATE	NAME
665d 9887	Thread Oil Cup Cover Oil Pad Screw for 68239.....
704w 8958	Looper Holder Screw.....
725j 8904	Cloth Plate Slide (left) Spring Screw for 54013.....
725j 8904	Cloth Plate Slide (right) Spring Screw for 54056 and 68192.....
742F 9884	Throat Plate Screw.....
761E 8901	Arm Rotary Shaft Bushing (front) Set Screw.....
761E 8901	Looper Driving Shaft and Feed Lifting Eccentric Bracket Bushing Set Screw for 54034.....
802d 8958	Presser Bar Lifting Lever Hinge Screw.....
896E 8904	Crank Connecting Rod Cap (lower) Screw for 54017.....
896E 8904	Feed Connecting Rod Cap Screw for 54111.....
906c 9881	Presser Foot Needle Guard Adjusting Screw for 68013.....
948d 8958	Looper Driving Shaft and Feed Lifting Eccentric Bracket Screw for 54182.....
948E 8958	Machine Screw, to fasten machine to base, for 54358 and 68224.....
965d 9888	Thread (under) Take-up Staple Bracket Screw.....
1011F 8904	Cloth Plate Screw (left).....
1019c 8958	Slack Thread Regulator Holder Collar Set Screw for 24292.....
1057E 8904	Crank Connecting Rod Cap (upper) Screw for 54017.....
1057E 8904	Feed Connecting Rod Clamping Screw for 54111.....
1103 8904	Feed Regulating Screw for 54025.....
1120c 8958	Looper (front) Set Screw for 54061.....
1133E 8958	Needle Bar Bushing (lower) Set Screw.....
1133E 8958	" " " (upper) Set Screw.....
1133E 8958	Presser Bar Bushing (lower) Set Screw.....
1133E 8958	" " " (upper) Set Screw.....
1147c 9883	Looper (back) Set Screw for 54061.....
1192c 8985	Belt Guard Hinge Pin Set Screw for 54357, obsolete.....
1192c 8985	Belt Guard Set Screw for 54356, obsolete.....
1235d 8904	Cloth Plate Thread Guard Screw.....
1250c 9884	Presser Bar Lifter Stop Screw.....
1253c 8958	Slack Thread Regulator Holder Shaft Crank Set Screw for 54044.....

NO.	PLATE	NAME
1253c	8958	Tension (upper thread, automatic) Cam Set Screw for 46383.....
1259c	8958	Arm Rotary Shaft Collar Set Screw for 54008.....
1284d	9888	Oil Cup Regulating Screw for 54189, obsolete.....
1423w	9888	Oil Cup Screw, obsolete.....
1449d	9888	Thread (upper) Take-up Plate Spring Screw for 54096.....
1498f	8958	Needle Set Screw for 54064.....
1499d	9888	Stay Guide Screw.....
1508j	9886	Tension (upper thread, automatic) Body Nut.....
1516i	8904	Crank Connecting Rod Ball Screw Stud Nut.....
1520j	9888	Needle Bar Connecting Link Hinge Stud Nut.....
1539w	9888	Pressure Regulating Thumb Screw Lock Nut.....
1547j	9885	Tension (upper thread) Releasing Shaft Stop Screw Nut.....
1560c	9885	Tension (upper thread, automatic) Regulating Thumb Nut for 53213.....
1872	8985	Presser Bar Lifter Roller and Stud for 61047.....
1963	8985	Presser Bar Guide Bracket Roller and Stud for 54039.....
2026	9888	Oil Cup Regulating Screw Spring for 54189, obsolete.....
2102	9885	Tension (under thread) Disc.....
2102	9885	" (upper thread, automatic) Disc..
2102	9885	" " " Disc.....
2117	8904	Arm Rock Shaft Crank (front) Pin.....
2763	8989	Rock Shaft for 23767.....
2766	8980	" " Knee Arm Hub with 356c, for 6336.....
2767	8980	Rock Shaft Knee Plate with 356c, for 6336
2770	8980	" " Stop Dog with 356c for 23767
4822	8941	Wrench for 1517 (Accessories).....
4879	8941	Chain Connecting Link.....
4882	8941	Treadle Shaft for 126252.....
5604	8952	Bench Stand Slide Spring Pin for 79611..
6055	8990	Machine Base Bolt Nut Washer for 54358 and 68224.....
6335	8980	Rock Shaft Knee Arm for 6336.....
6336	—	Rock Shaft Knee Arm complete for 23767, Nos. 2766, 2767 and 6335.....

NO.	PLATE	NAME
6337	8980	Rock Shaft Lifting Bracket with two 356c, for 23767.....
6439	—	Chain, 36 in. to 45 in., with 56864 and 56865.....
6575	8904	Crank Connecting Rod Oil Pad Stop Pin for 54017.....
7071	8904	Feed Eccentric Clamping Washer for 54025.....
7125	8980	Rock Shaft Lifting Bracket Hook, for 23767.....
8908	8941	Wrench for 1520 (Accessories).....
9370	8952	Bench Stand Slide Spring for 79611.....
11173	8985	Presser Bar Guide Bracket Guide.....
12242	8980	Rock Shaft Hanger with two wood screws 1 in. No. 10, for 23767.....
15196	8902	Arm Side Cover (back).....
17547	9885	Tension (under thread) Thread Guide....
19224	8941	Wrench for 1516 (Accessories).....
24506	8904	Feed Connecting Rod Hinge Pin Collar with 457c, for 54077.....
*23729	—	Feed Eccentric Body for 54025.....
23767	8980	Rock Shaft complete, Nos. 2763, 2770, 6336, 6337, 7125 and two 12242.....
24292	8990	Slack Thread Regulator Holder Shaft Collar with 1019c.....
25303	8990	Presser Bar Ball, size ¼ in., for 64330...
26026	8941	Screw Driver, large (Accessories).....
26276	9881	Presser Foot Hinge Pin for 68246.....
26485	8941	Screw Driver, small (Accessories).....
27347	8985	Belt Guard Hinge Pin for 54358, obsolete
27739	8996	Thread Unwinder Thread Cone (wood) for large cones, for 225398.....
28994	8938	Tape Holder (5 in. diam.) complete, for under the bench, Nos. 55b, 36795, 36796 and two wood screws 1½ in. No. 10...
32572	9885	Tension (under thread) Releasing Disc...
32572	9885	" (upper thread, automatic) Releasing Disc.....
32572	9885	Tension (upper thread) Releasing Disc...
35717	9888	Stay Guide (lower) for 35719.....
35718	9888	" " (upper) for 35719.....
35719	—	Stay Guide complete, Nos. 35717 and 35718.....
36795	8938	Tape Holder Body for 28994.....
36796	8938	" " Cover for 28994.....
37563	—	Chain, length 15 in., with 56864 and 56865
38100	9888	Oil Cup Packing (felt) for 54189, obsolete

NO.	PLATE	NAME
38210	9885	Thread (under) Nipper Spring (lower)...
38211	9885	“ “ “ (upper)...
38419	8904	Cloth Plate Slide (left) Spring for 54013.
38419	8904	“ “ “ (right) Spring for 54056 and 68192.....
38456	9882	Needle Bar Bushing (lower).....
38456	9882	Presser Bar Bushing (upper).....
38468	8990	“ “ Spring Stud.....
38475	9886	Thread (under) Take-up with 465c.....
38481	9886	Thread (under) Take-up Staple Thread Guard for 54435.....
38482	9885	Thread (under) Take-up Stripper.....
38487	8941	Threading Wire (Accessories).....
40326	8990	Looper Driving Shaft and Feed Lifting Eccentric Oil Pad (braided cotton).....
41538	—	Bench Stand Flush Bolt with Plate com- plete, for 79614, Nos. 126247, 126248 and four brass wood screws $\frac{5}{8}$ in. No. 4
42366	8901	Arm Oil Pad (braided cotton) for oiling Arm Rock Shaft Front Bearing .....
46009	9886	Thread (upper) Eyelet.....
46041	9885	“ (under) Take-up Staple Spring...
46087	—	Presser Foot Shank for 68246.....
46111	9888	Face Plate Pin.....
46247	9885	Thread (under) Nipper Spring (upper) Stop.....
46383	9886	Tension (upper thread, automatic) Cam with two 1253c, for 54192.....
46385	9885	Tension (upper thread, automatic) Screw Stud Releasing Pin.....
46387	9885	Tension (upper thread, automatic) Spring
49013	8904	Arm Rotary Shaft Front Bearing Oil Pad (braided cotton).....
49013	8901	Looper Carrier Connection Shaft Oil Pad (braided cotton).....
49092	9887	Oil Packing (felt) for 54110, obsolete.....
49092	9887	Thread Oil Cup Oil Pad (felt) for tube, for 68239.....
49123	8996	Machine Base Oil Pipe for 54358 and 68224.....
50069c	8901	Crank Connecting Rod Ball Screw Stud for 54088.....
50083c	8901	Arm Rock Shaft Crank (back) Set Screw for 54184.....
50084c	8901	Arm Rotary Shaft Bushing (intermediate) Set Screw (short).....

NO.	PLATE	NAME
50106c	9885	Tension (upper thread, automatic) Screw Stud for 53213.....
50150c	8958	Slack Thread Regulator Holder Set Screw for 54042.....
50326c	9885	Tension (under thread) Screw Stud for 59539.....
50326c	9885	Tension (upper thread) Screw Stud for 59539.....
50411d	9887	Thread Oil Cup Cover Latch Spring Screw for 68239.....
50429c	8904	Feed Dog Stop Screw for 54019.....
50473F	8904	Cloth Plate Screw (right).....
51061c	8958	Feed Eccentric Body Set Screw for 54025
51072E	9888	Machine Base Bolt with 51581E, for 54358 and 68224.....
51570c	9885	Tension (under thread) Regulating Thumb Nut for 59539.....
51570c	9885	Tension (upper thread) Regulating Thumb Nut for 59539.....
51581E	9888	Machine Base Bolt Nut for 51072.....
52045	8901	Arm Oil Tube Packing (braided cotton) for 56003.....
52045	8901	Arm Rock Shaft Bushing Oil Pad (braided cotton).....
52045	8901	Arm Rock Shaft Flanged Bushing (front) Oil Pad (braided cotton).....
52045	8901	Arm Rotary Shaft Bushing (front) Oil Pad (braided cotton).....
53213	—	Tension (upper thread, automatic) Screw Stud 50106c with 1560c.....
53225	9886	Thread (under) Eyelet (back).....
54004	8901	Arm Rock Shaft Collar with two 453c, for 54192.....
*54006	8938	Arm Rotary Shaft for 54448.....
NOTE: When No. 54006 is required for repairs, the Looper Driving Shaft and Feed Lifting Eccen- tric must be returned to the factory to be adjusted to the new part.		
54007	8902	Arm Rotary Shaft Bushing (intermediate) for 54089.....
54008	8901	Arm Rotary Shaft Collar with three 1259c, for 54448.....
54009	8902	Arm Rotary Shaft Flanged Bushing for 54090.....
54010	8904	Arm Side Cover (front).....
54012	8902	Cloth Plate Slide (left) for 54013.....

NO.	PLATE	NAME
54013	—	Cloth Plate Slide (left) complete for 54200, and 68268, Nos. 38419, 54012 and two 7251.....
54017	8902	Crank Connecting Rod with 6575, 54018, 54218, 54897, 57222 and two each 896E and 1057E, for 54088.....
*54018	—	Crank Connecting Rod Cap (upper) for 54017.....
54019	8902	Feed Bar with 50429c and two 453c, for 54077.....
54020	8902	Feed Bar Connection for 54077.....
54023	9882	" Connecting Rod Hinge Pin for 54077.....
*54024	—	" Eccentric for 54025.....
54025	8985	Feed Eccentric (adjustable) complete for 54113, Nos. 217b, 1103c, 7071, 23729, 54024 and two 54061c.....
54026	9873	Feed Rocking Frame with two 453c, for 54077.....
54027	9883	Looper Carrier with two 171b, for 54447.....
*54032	—	" " Driver Cap for 54230.....
*54031	—	" Driving Shaft and Feed Lifting Eccentric Bracket with 761E, for 54182.....
54038	9884	Needle Guard Holder.....
54039	8985	Presser Bar Guide Bracket with 453c, 640w and 1963.....
54040	9873	Presser Bar Spring (flat).....
54042	8990	Slack Thread Regulator Holder with 175E and two 50150c.....
54043	8990	Slack Thread Regulator Holder Shaft.....
54044	8990	" " " " " " Crank (forked) with 1253c.....
54047	9886	Tension (upper thread) Releasing Shaft Crank with 621c.....
54048	9886	Tension (upper thread) Releasing Shaft Crank Link.....
54049	9873	Thread (under) Take-up Staple Bracket with 460c.....
54055	9889	Cloth Plate Slide (right) for 54056.....
54056	—	Cloth Plate Slide (right) complete for 54200, Nos. 38419, 54055 and two 7251.....
54061	8990	Looper Holder with 1120c and 1147c.....
54062	—	Needle Bar complete, for $\frac{3}{8}$ in. to $\frac{1}{4}$ in. gauges, Nos. 54064, 54065 and 64319..
54063	—	Needle Bar complete, for $\frac{9}{16}$ in. to $\frac{3}{8}$ in. gauges, Nos. 54064, 54066 and 64319..
54064	9884	Needle Clamp with two 1498E, for 54062 and 54063.....

NO.	PLATE	NAME
54065	9884	Needle Clamp Thread Guard, for $\frac{3}{8}$ in. to $\frac{1}{4}$ in. gauges, for 54062.....
54066	9884	Needle Clamp Thread Guard, for $\frac{9}{16}$ in. to $\frac{3}{8}$ in. gauges, for 54063.....
54067	9884	Needle Guard for $\frac{3}{8}$ in. to $\frac{5}{16}$ in. gauges.....
54068	9884	" " " $\frac{3}{16}$ in. to $\frac{3}{16}$ in. gauges.....
54069	9884	" " " $\frac{5}{16}$ in. to $\frac{3}{8}$ in. gauges.....
54070	8996	Tension (upper thread) Bracket.....
54071	9889	" " " Releasing Shaft.....
54072	9886	Thread (under) Eyelet (front).....
54077	—	Feed Rocking Frame 54026 with 21506, 54019, 54020, 54023 and 57225.....
54080	8990	Looper Driving Shaft and Feed Lifting Eccentric Bracket Bushing.....
54081	8901	Arm Rotary Shaft Bushing (front).....
54088	—	Crank Connecting Rod 54017 with 50069c for 54448.....
54089	—	Arm Rotary Shaft Bushing (intermediate) 54007 with 64508 and 64805.....
54090	—	Arm Rotary Shaft Flanged Bushing 54009 with 58039 and 64805.....
54094	9888	Thread (upper) Take-up for 54096.....
54095	9888	" " " Plate for 54096.....
54096	—	Thread (upper) Take-up complete, Nos. 1449b, 54094, 54095 and 68164.....
54103	9873	Presser Bar Lifting Lever Extension, obsolete.....
54104	8938	Cloth Plate Thread Guard.....
54105	8901	Arm Rock Shaft Flanged Bushing (front).....
54106	9883	Looper (back) closed eye.....
54107	9883	" (front) closed eye.....
54108	—	Oil Tube for 54110, obsolete.....
54109	—	" " Bracket for 54110, obsolete.....
54110	8990	Oil Tube complete, for oiling crank connecting rod (upper bearing), Nos. 49092, 54108 and 54109, obsolete.....
54111	8902	Feed Connecting Rod with 1057E, 54112 and two 896E, for 54113.....
*54112	—	Feed Connecting Rod Cap for 54111.....
54113	—	" " " 54111 with 54025, for 54448.....
*54182	—	Arm, upper and lower (solid) with 948b and 54034.....
54183	8938	Arm Rock Shaft for 54192.....
54184	8985	" " " Crank (back) with two 50083c, for 54192.....
54188	9888	Oil Cup for 54189, obsolete.....

NO.	PLATE	NAME
54189	—	Oil Cup complete, for oiling upper thread, Nos. 1284b, 2026, 38100 and 54188, obsolete, use 68239.
54192	—	Arm Rock Shaft 54183, with 46383, 54004, 54184 and 64255.
54199	8938	Cloth Plate for 54200 and 68268.
54200	—	Cloth Plate complete, for $\frac{3}{16}$ in. to $\frac{1}{4}$ in. gauges, Nos. 54013, 54056 and 54199.
54210	9889	Balance Wheel, $2\frac{5}{8}$ in. pulley, with two 430c.
54216	9886	Tension (upper thread, automatic) Body.
54218	8904	Crank Connecting Rod Oil Pad (braided cotton) for 54017.
54227	9883	Looper Carrier Connection for 54447.
54228	9883	" " " Shaft for 54447
54229	9883	" " " " Bushing
54230	9883	" " Driver with 54032 and four 175e, for 54447.
54242	8990	Slack Thread Controller Clamp.
54244	9886	Tension (upper thread, automatic) Thread Guide.
54326	9882	Needle Bar Connecting Link for 54329.
54327	9882	" " " " Hinge Stud for 54329.
54328	9882	Needle Bar Connecting Stud with 211f and two 187e, for 54329.
54329	—	Needle Bar Connecting Link 54326 with 54327 and 54328.
54330	9886	Thread (upper) Controller.
54333	9886	Tension (upper thread, automatic) Body Releasing Pin.
54337	9881	Feed Dog, 17 teeth (16 teeth to the inch) for 54338.
54338	9881	Throat Plate, for $\frac{7}{32}$ in. to $\frac{3}{8}$ in. gauges, for 54337.
54356	8980	Belt Guard with 1192c, for 54358, obsolete.
54357	8980	Machine Base with 1192c, for 54358, obsolete.
54358	—	Machine Base with Belt Guard complete, Nos. 27347, 49123, 54356, 54357, 60884, three each 6055, 51072e and four each 948e and 57285, obsolete.
54381	9884	Slack Thread Controller.
54435	9886	Thread (under) Take-up Staple with 590b and 38481.

NO.	PLATE	NAME
*54440	8990	Looper Driving Shaft and Feed Lifting Eccentric with 227b and two 64315, for 54447.

NOTE: When No. 54440 is required for repairs, the Arm Rotary Shaft must be returned to the factory to be adjusted to the new part.

54447	—	Looper Driving Shaft and Feed Lifting Eccentric 54440, with 54027, 54227, 54228 and 54230, for 54448.
54448	—	Arm Rotary Shaft 54006 with 640b, 54008, 54088, 54113, 54447, 64351 and 64355.
54515	9887	Thread Oil Cup Cover Hinge Pin for 68239
54897	8904	Crank Connecting Rod Oil Cup for 54017
51988	9885	Tension (upper thread) Releasing Pin.
54990	9886	" " " " Shaft Spring.
56003	8985	Arm Oil Tube with 52045 for oiling 54326
56006	8901	" " Pad (braided cotton) for oiling Arm Rock Shaft Intermediate Bearing
56864	8941	Chain Hook (large) for 6439 and 37563.
56865	8985	Chain Hook (small) for 6439 and 37563.
57076	9885	Tension (upper thread) Thread Guide (double).
*57222	—	Crank Connecting Rod Cap (lower) for 54017.
57225	8904	Feed Bar Hinge Pin for 54077.
57234	9882	" Rocking Frame Hinge Pin.
57235	8985	" " " " Bushing
57257	9882	Presser Bar Lifter.
57258	9882	" " " Hinge Pin.
57285	8996	Machine Cushion (felt) for 54358 and 68224.
58039	8902	Arm Rotary Shaft Flanged Bushing Oil Pad, long (braided cotton) for 54090.
59534	9885	Tension (under thread) Spring.
59535	9885	" (upper thread) Spring.
59537	9885	" (under thread) Spring Bushing (large).
59537	9885	Tension (upper thread) Spring Bushing (large).
59538	9885	Tension (under thread) Spring Bushing (small).
59538	9885	Tension (upper thread) Spring Bushing (small).
59539	—	Tension (under thread) Screw Stud 50326c with 51570c.



NO.	PLATE	NAME
59539	—	Tension (upper thread) Screw Stud 50326c with 51570c.....
60656	8952	Bench Stand Hinge for 79611.....
60884	8985	Machine Base Oil Pipe Plug for 54358 and 68224.....
61047	9884	Presser Bar Lifting Bracket with 460c and 1872.....
61075	9884	Presser Bar Lifting Lever Connecting Stud
64255	9882	Arm Rock Shaft Crank (front) with 453c, for 54192.....
64268	8904	Crank Connecting Rod Ball Screw Stud Washer.....
64269	9889	Face Plate.....
64315	8990	Looper Driving Shaft and Feed Lifting Eccentric Oil Hole Plug for 54440.....
64319	9884	Needle Bar (hollow) for 54062 and 54063
64320	9882	“ “ Bushing (upper).....
64330	9873	Presser Bar with 25303.....
64331	9882	“ “ Bushing (lower).....
64337	9884	Slack Thread Regulator.....
64351	9886	Thread (under) Nipper Cam with 465c for 54448.....
64355	9886	Thread (under) Take-up Thread Guard (brass) for 54448.....
64356	9886	Thread (under) Take-up Thread Guard Steady Pin.....
64362	8996	Presser Bar Lifting Lever, obsolete.....
64386	8901	Arm Rock Shaft Bushing (back).....
64388	8901	“ “ “ “ (intermediate)
64508	8902	“ Rotary Shaft Bushing (intermediate) Oil Pad, long (braided cotton) for 54089
64805	8985	Arm Rotary Shaft Bushing (intermediate) Oil Pad, short (braided cotton) for 54089
64805	8985	Arm Rotary Shaft Flanged Bushing Oil Pad, short (braided cotton) for 54090 .
68011	9881	Feed Dog, 16 teeth (16 teeth to the inch) for 68014.....
68012	9881	Presser Foot Needle Guard for 68013.....
68013	9881	“ “ with 240w, 68012 and two 906c, for $\frac{3}{32}$ in. to $\frac{3}{16}$ in. gauges.....
68014	9881	Throat Plate, for $\frac{3}{32}$ in. to $\frac{3}{16}$ in. gauges, for 68011.....
68164	9888	Thread (upper) Take-up Plate Spring for 54096.....
68184	9873	Presser Bar Lifting Lever Extension.....
68191	—	Cloth Plate Slide (right) for 68192.....

NO.	PLATE	NAME
68192	—	Cloth Plate Slide (right) complete for 68268, Nos. 38419, 68191 and two 725J
68208	9873	Presser Bar Lifting Lever.....
68222	9879	Belt Guard with two wood screws 1 in. No. 12.....
68223	9879	Machine Base for 68224.....
68224	—	Machine Base complete, Nos. 49123, 60884, 68223, three each 6055, 51072E and four each 948E and 57285.....

## Nos. 68234 TO 68238 FOR 68239

68234	9887	Thread Oil Cup.....
68235	9887	“ “ “ “ Cover.....
68236	9887	“ “ “ “ Latch Spring.....
68237	9887	“ “ “ “ Oil Pad (felt).....
68238	9887	“ “ “ “ Oil Pad (felt) for cup.....
68239	9887	Thread Oil Cup and Oil Tube complete for oiling upper thread and crank connecting rod (upper bearing), Nos. 49092, 50111, 54515, 68234 to 68238 and two 665b.....
68244	9881	Presser Foot Needle Guard for 68246.....
68245	—	“ “ Plate for 68246.....
68246	9881	Presser Foot (hinged) complete, for $\frac{3}{32}$ in. to $\frac{3}{8}$ in. gauges, Nos. 26276, 46087, 68245 and two each 337w and 68244 .
68268	—	Cloth Plate complete, for $\frac{3}{32}$ in. to $\frac{3}{8}$ in. gauges, for 54338, Nos. 54013, 54199 and 68192.....
79611	—	Bench Stand with 5604, 9370, two 41538, three wood screws $1\frac{1}{4}$ in. No. 14, four 60656 and sixteen wood screws $\frac{5}{8}$ in. No. 7.....
120341	8941	Tweezers (curved) Accessories.....
120344	8941	Oiler (copper plated) with 120345 (Accessories).....
120345	8941	Oiler Spout, 5 in. long, for 120344.....
126247	8952	Bench Stand Flush Bolt for 41538.....
126248	8952	“ “ “ “ “ Plate for 41538.....
126249	8980	Treadle for 126252.....
126250	8941	“ Spring for 126252.....
126251	8980	“ Stand for 126252.....
126252	8980	Treadle complete, Nos. 4882, 126249 to 126251 and two wood screws 1 in. No. 16.....

NO.	PLATE	NAME
200383c	8985	Thread Unwinder Spool Rest Rod Set Screw for 202490.....
201018	8985	Thread Unwinder Spool Rest Set Screw for 225395.....
201696j	9888	Thread Unwinder Thread Guide Lock Nut for 225398.....
202490	8953	Thread Unwinder Spool Stand with 200383c, for 225398.....
225388	8953	Thread Unwinder Spool Rest Rod for 225398.....
225390	8996	Thread Unwinder Thread Cone Holder, for inverted cones, for 225398.....
225391	8953	Thread Unwinder Thread Guide for 225398
225392	8953	“ “ “ “ Rod with 208E and 225393, for 225398.....
225393	9888	Thread Unwinder Thread Guide Rod Washer for 225392.....
225395	8953	Thread Unwinder Spool Rest (for two spools) with 201018c, for 225398.....
225398	8953	Thread Unwinder complete, for four spools, Nos. 201696j, 202490, 225388, 225392 to 225395, four 225391 and three wood screws $\frac{7}{8}$ in. No. 12.....

**Genuine Singer Needles and their Con-  
tainers are marked with the Company's  
Trade Mark "SIMANCO."** 1

**Needles in Containers marked  
"For Singer Machines"  
are not Singer made needles.** 2

**ILLUSTRATIONS OF PARTS  
FOR  
MACHINE No. 147-35**

**PLATE 8901—FULL SIZE**

42366



56006



11119



29599



446



423



64386



64388



52045



453



54004

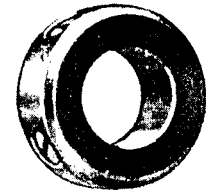

54005

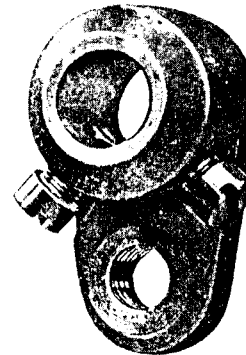

50083



2117



54105

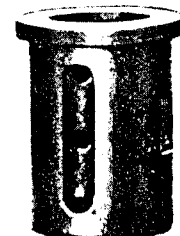

54081



54008

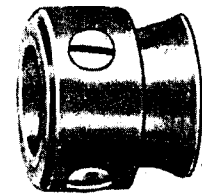

42367



761



422



50084



159



1258



144

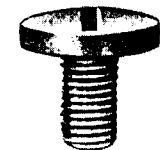
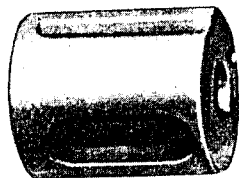

PLATE 8902—ONE-HALF SIZE

54002



54007



54009

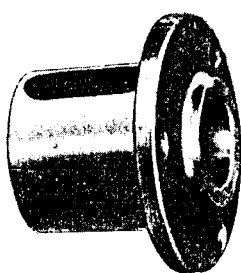

54017 64508 58039

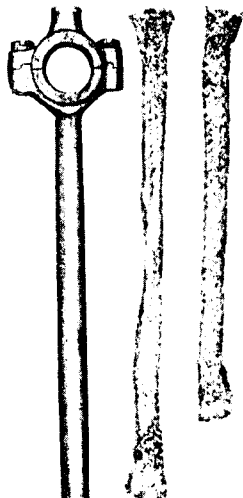

15196

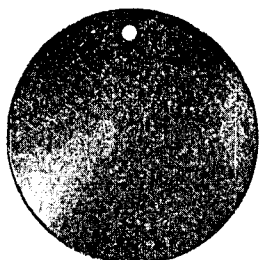

54012



54019

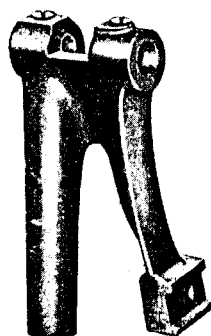

54111

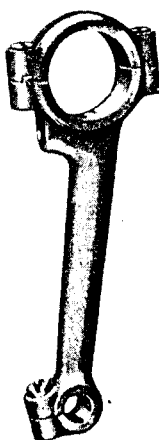

54020

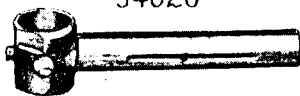

PLATE 8904—FULL SIZE

49013



286



54010



430



50473



1011



38419



725

1235



50069



1516



64268



896



1057



54897



57225



21506



457



54218



6575



443



7071



50429



61171



1103



157



21332



934



934



PLATE 8938—ONE-FOURTH SIZE

54199

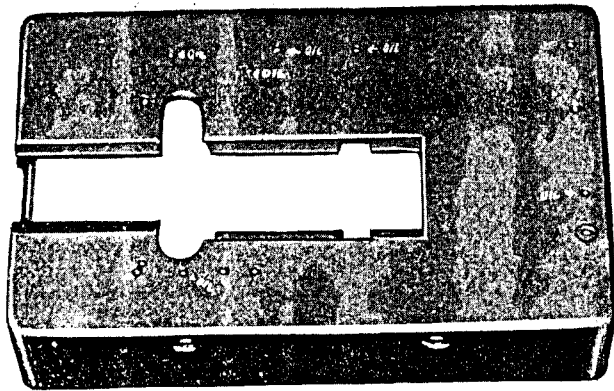

54006



54183



28994

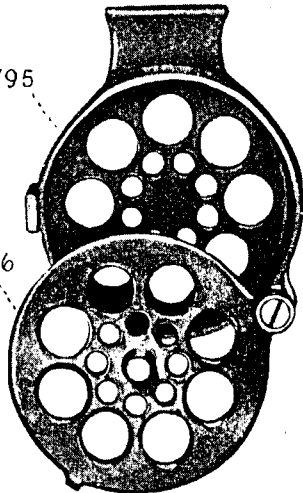

36795

36796

54104

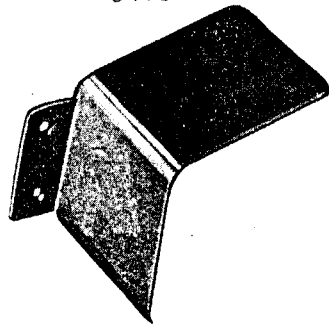
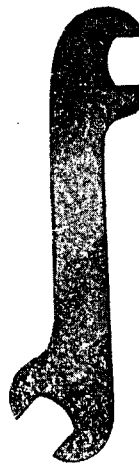

PLATE 8941—ONE-HALF SIZE

19221



4822



8908

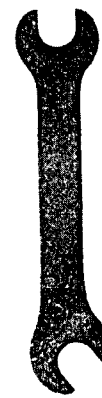

120344



26485



120345

38487



26026



120341



4879



56864



126250



4882

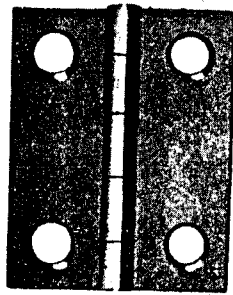

PLATE 8952—FULL SIZE

9370

126247

124500



126248

5604



27998

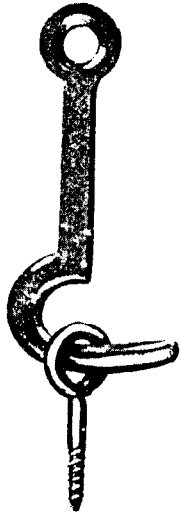

60656

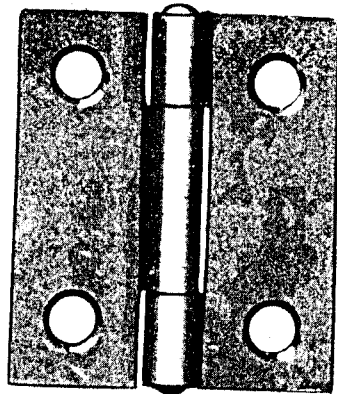

PLATE 8953—ONE-SIXTH SIZE

225398

225391

225391

225392

225395

225395

225388

202490

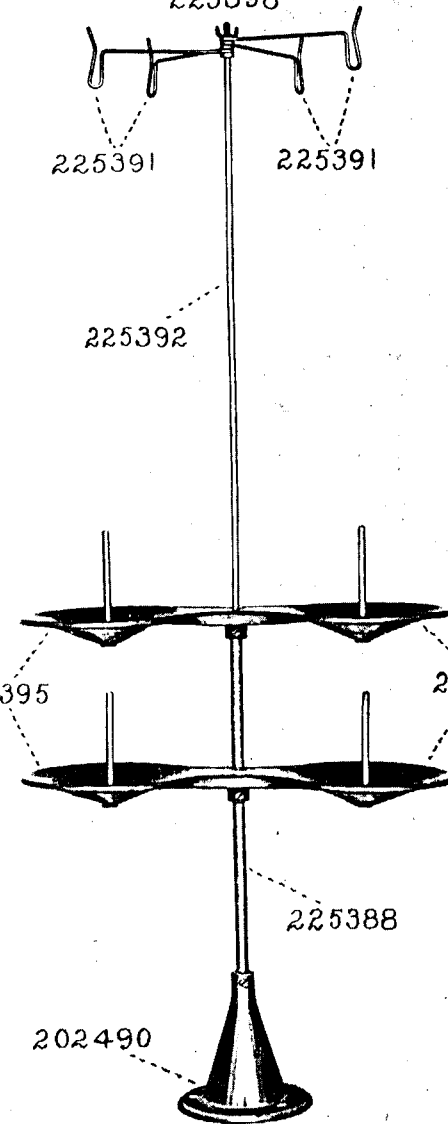

PLATE 8958—FULL SIZE

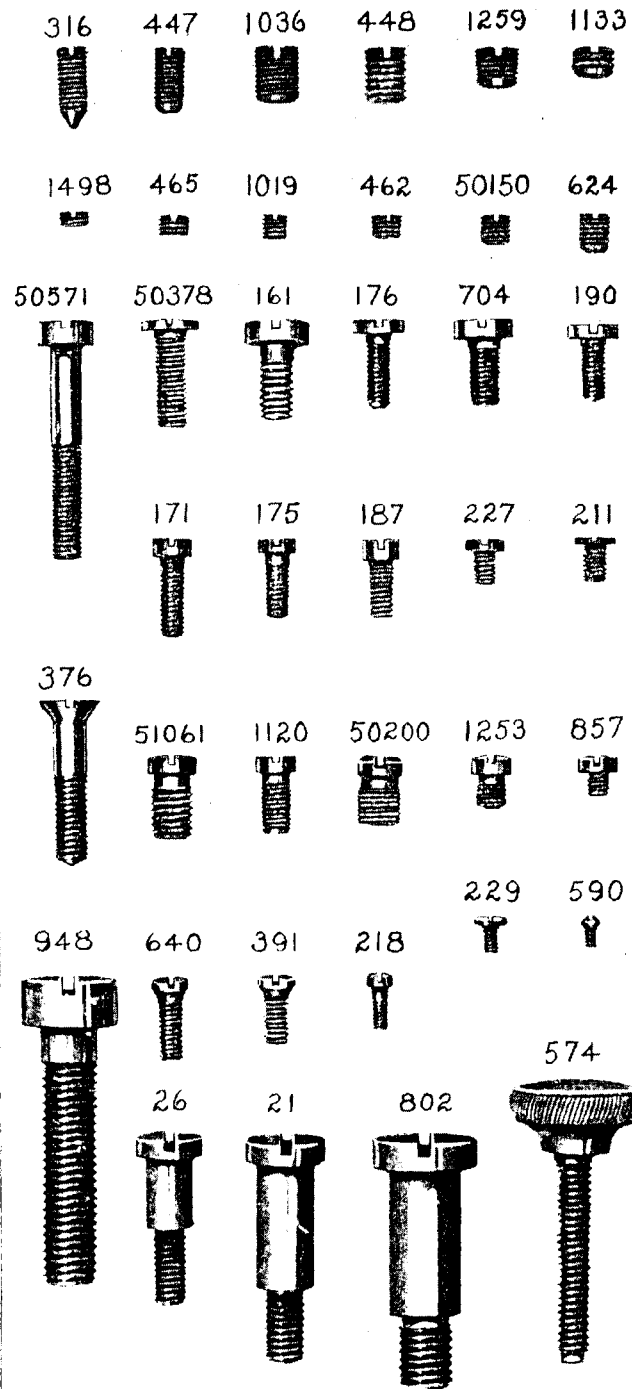

PLATE 8980—ONE-FOURTH SIZE

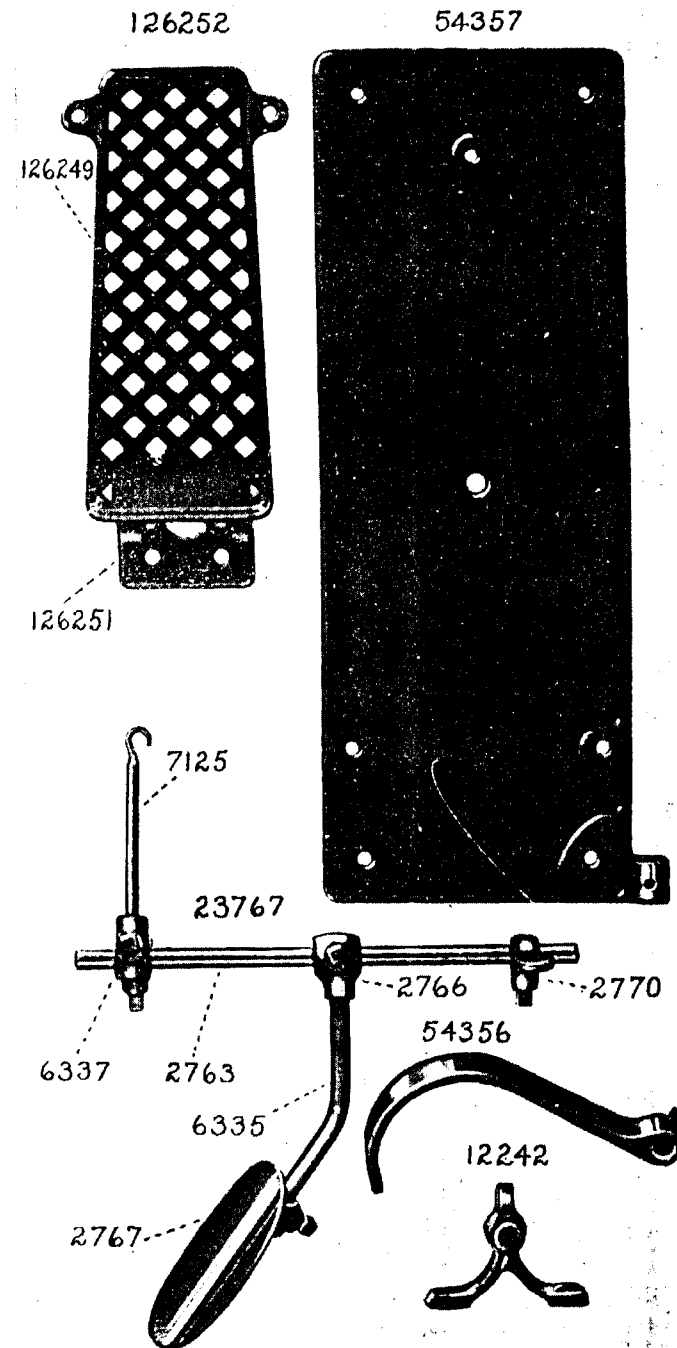

PLATE 8985—FULL SIZE

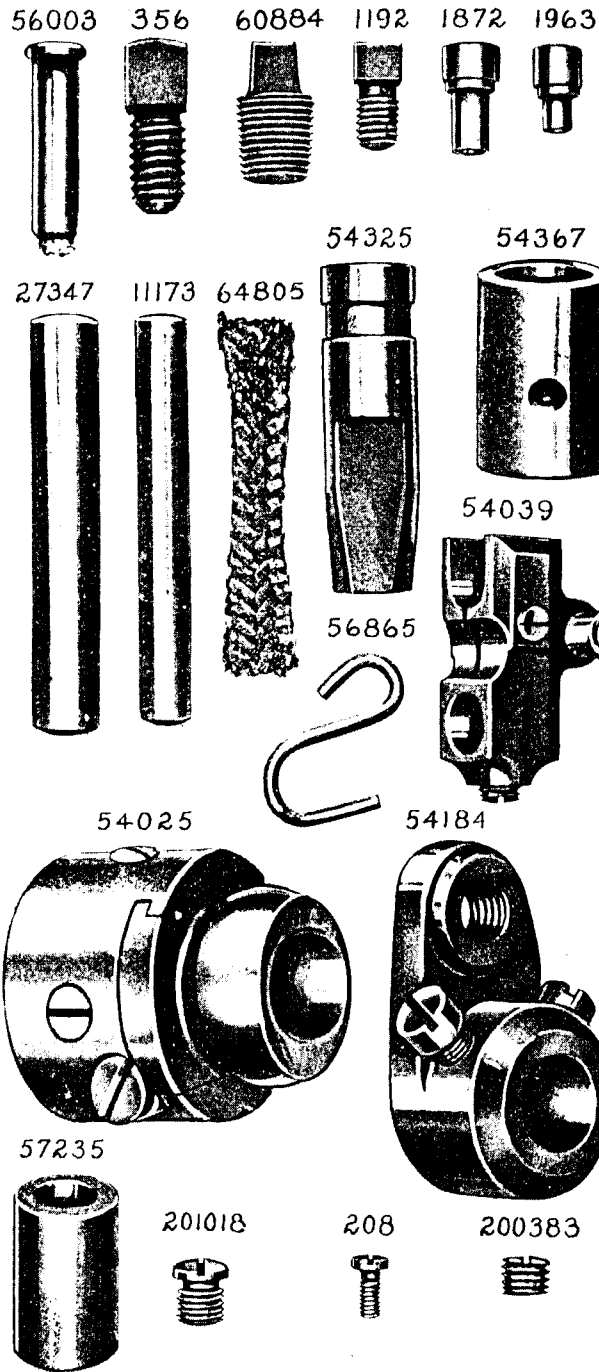

PLATE 8990—FULL SIZE

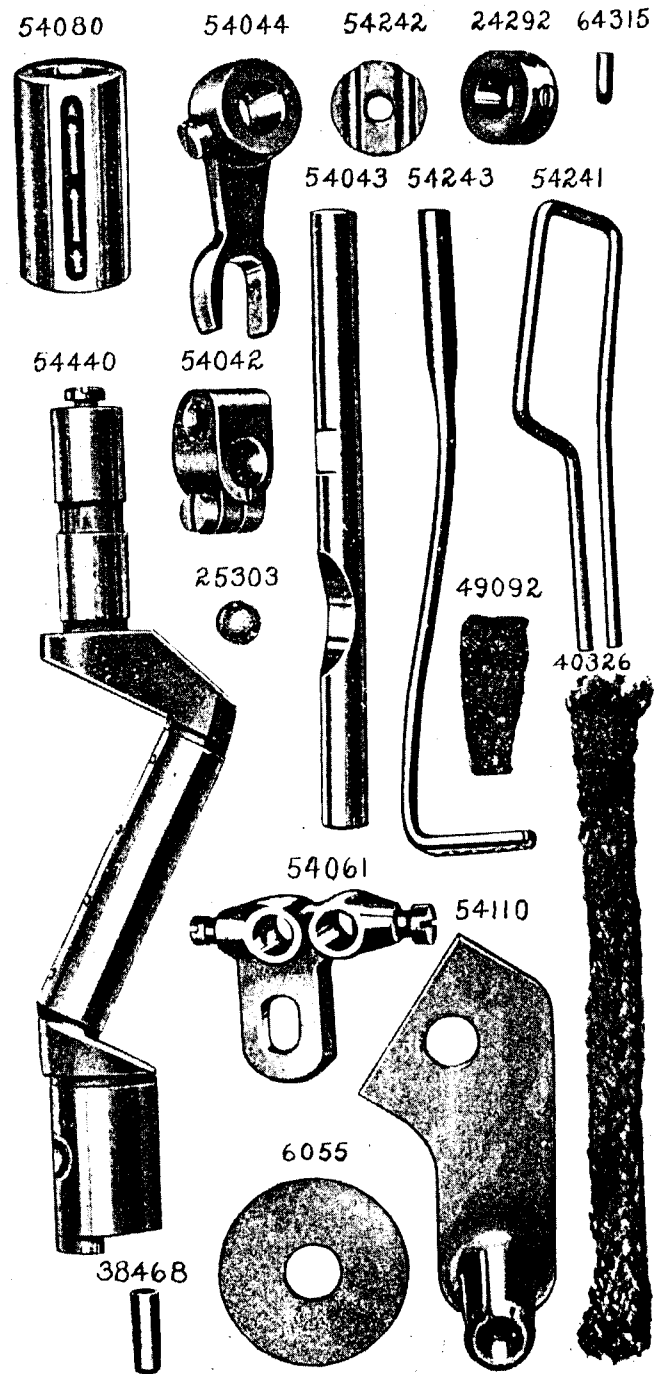
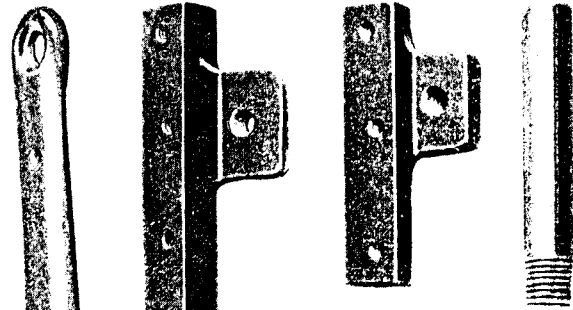

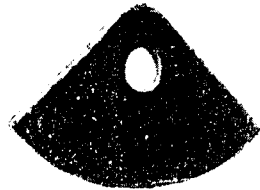

PLATE 8996—ONE-HALF SIZE

64362 54245 54070 49123



57285



225390

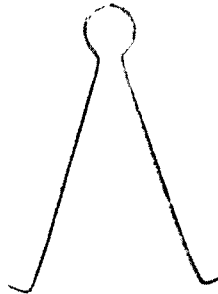

27739

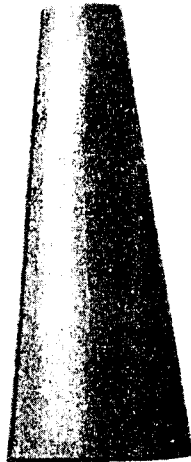
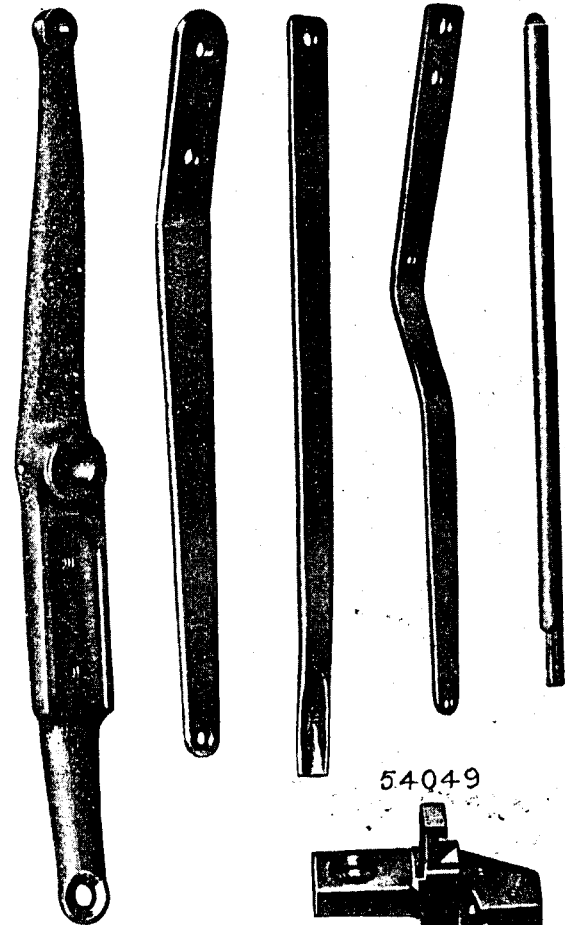
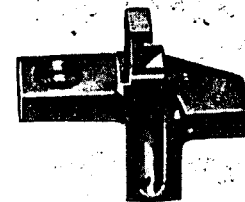

PLATE 9873—ONE-HALF SIZE

68208 68184 54040 54103 64330



54049



54026

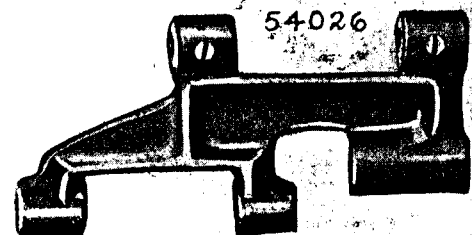

PLATE 9879—ONE-FOURTH SIZE

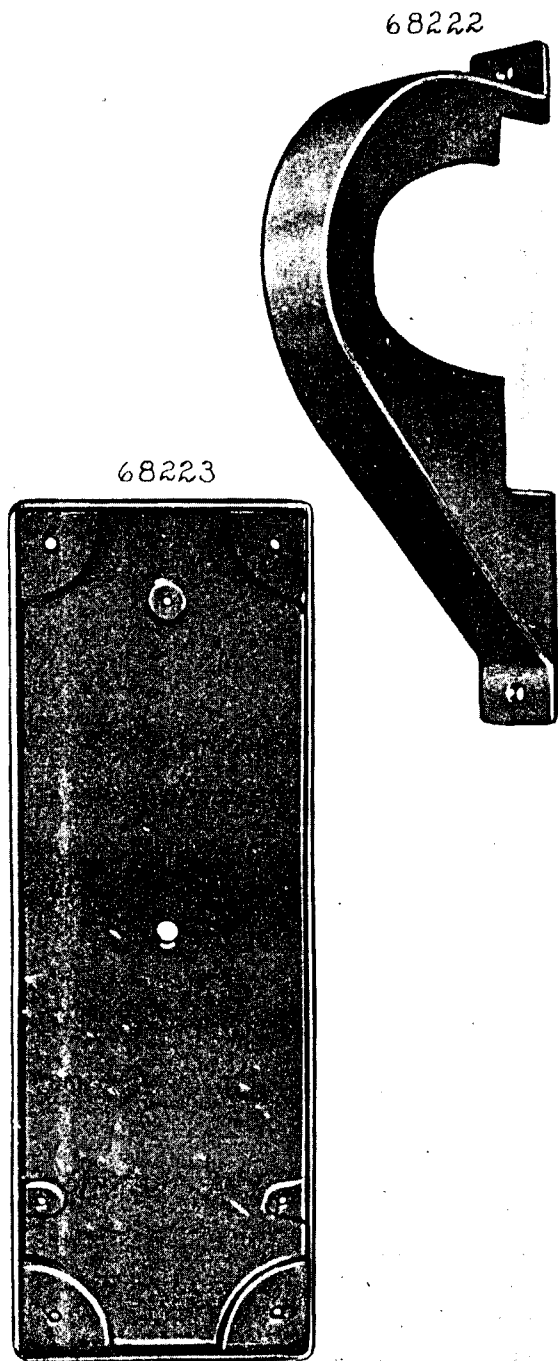

PLATE 9881—FULL SIZE

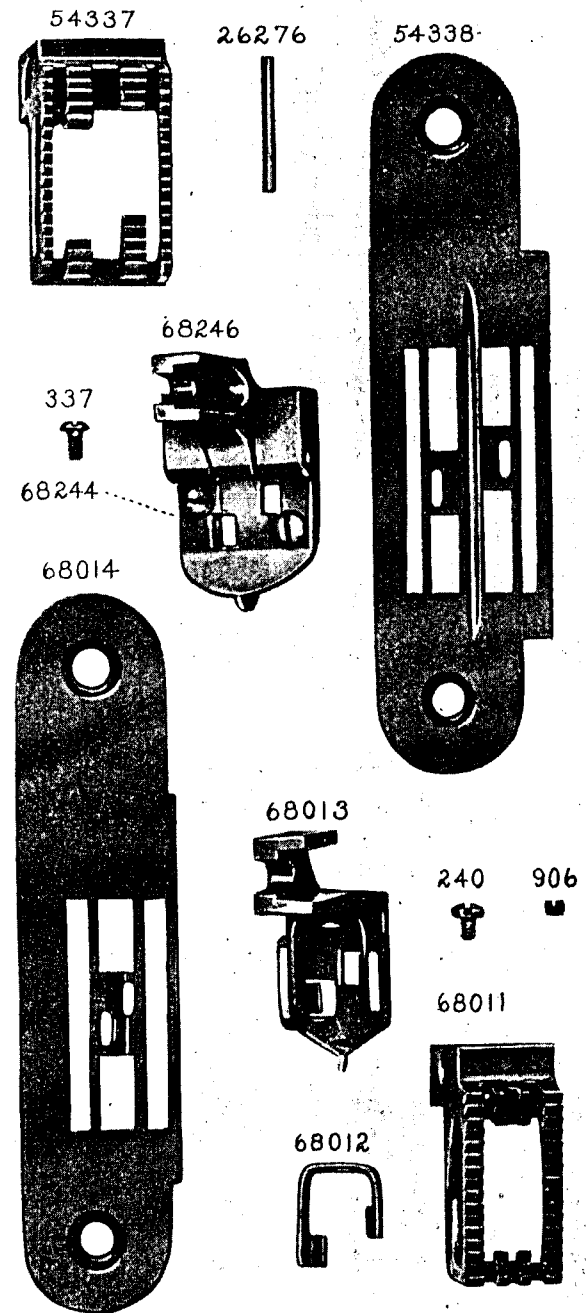

PLATE 9882—FULL SIZE

57234



54023



64331



64320



64255

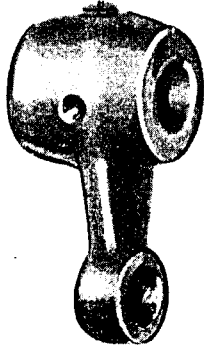

57258



57257



54327



54326

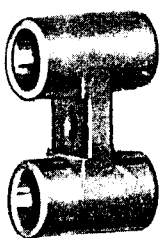

54328



38456

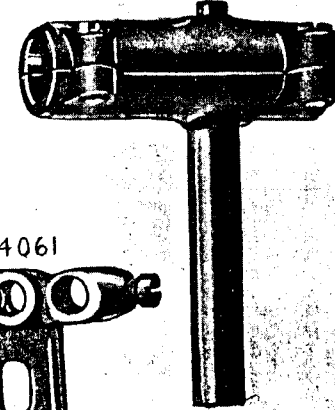

PLATE 9883—FULL SIZE

54228



54230



54061

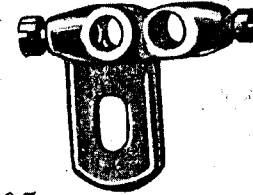

54227

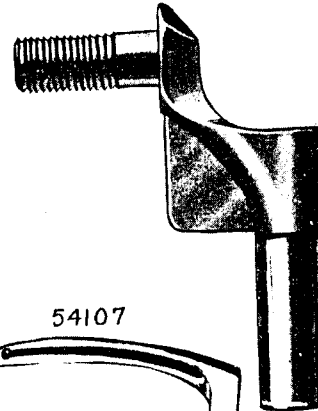

54027

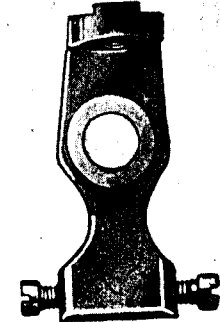

54107

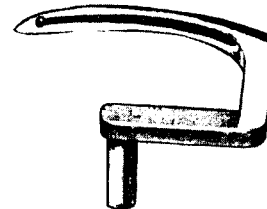

54229



54106

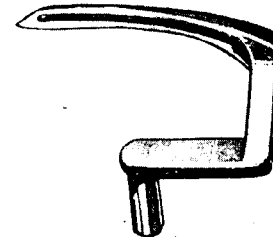

1120



1147



PLATE 9884—FULL SIZE

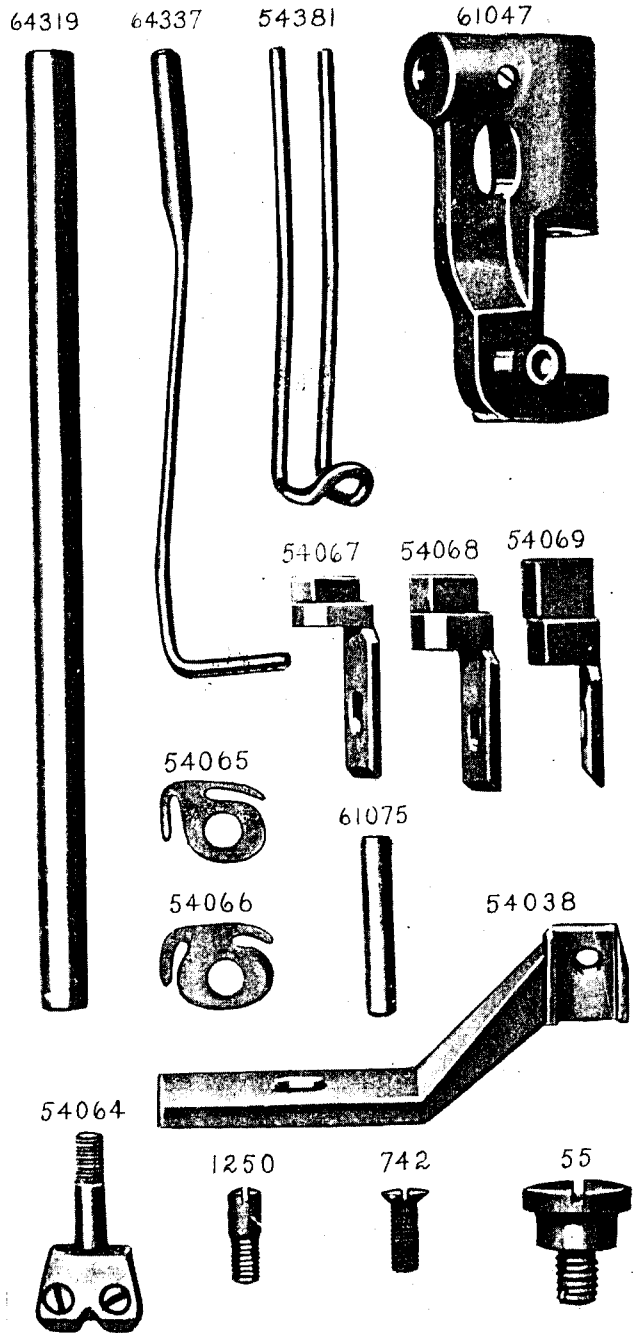

PLATE 9885—FULL SIZE

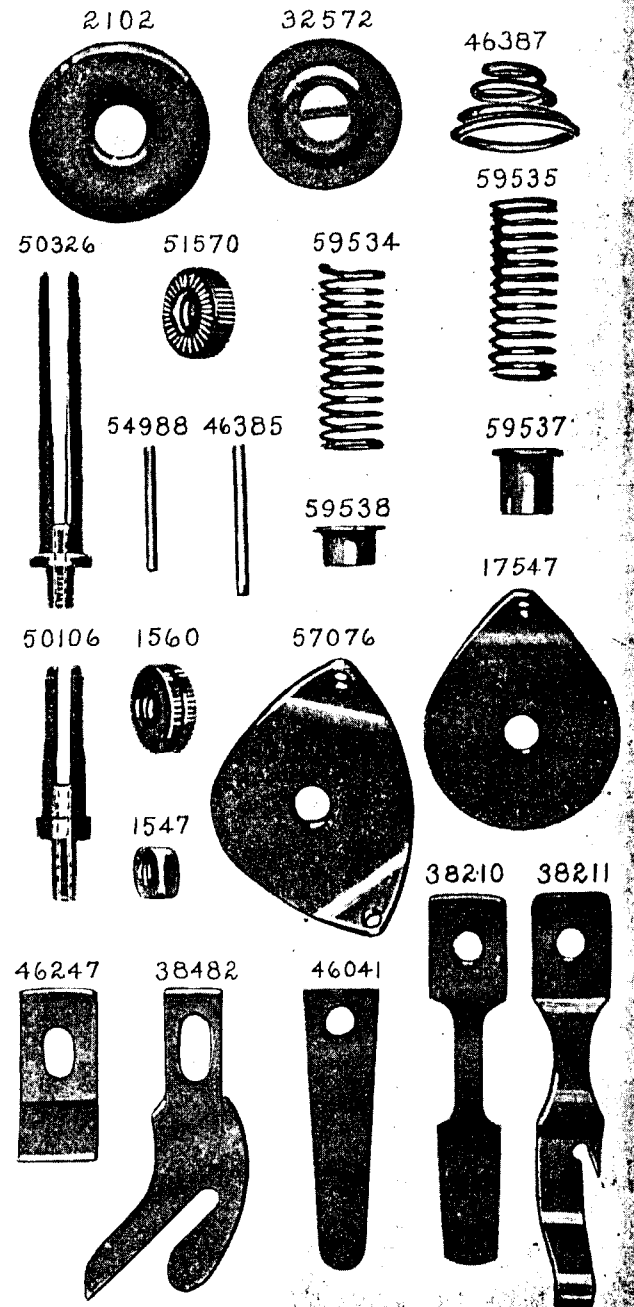

PLATE 9886—FULL SIZE

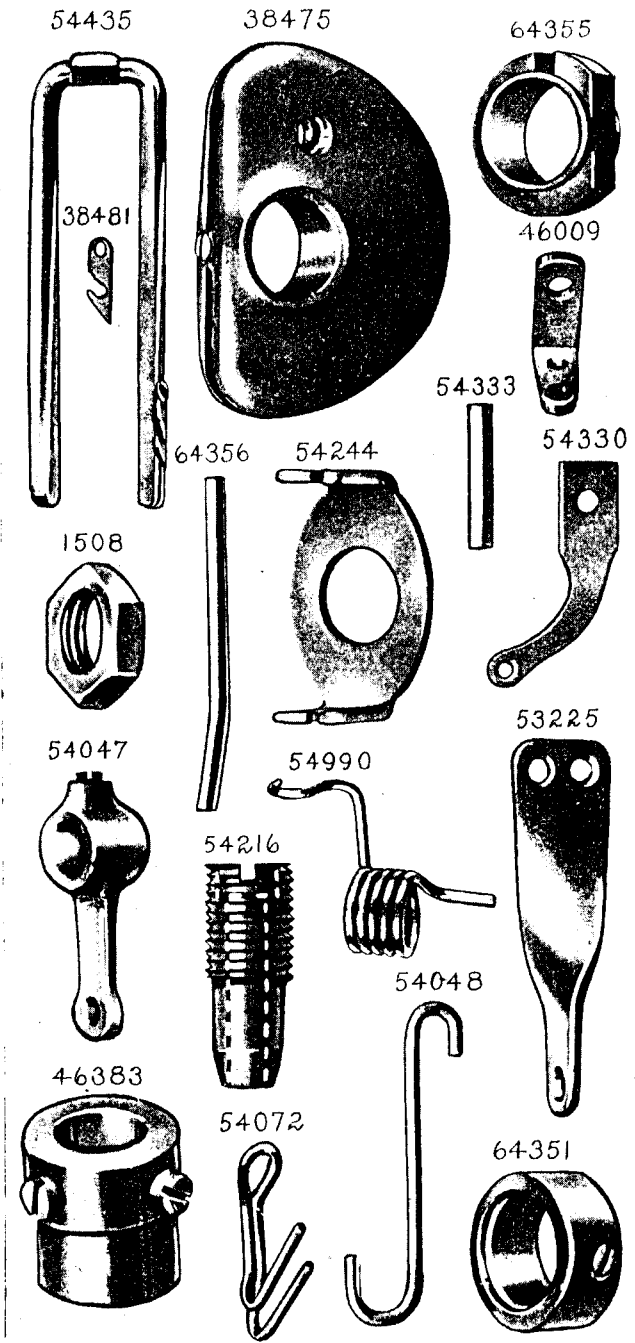

PLATE 9887—FULL SIZE

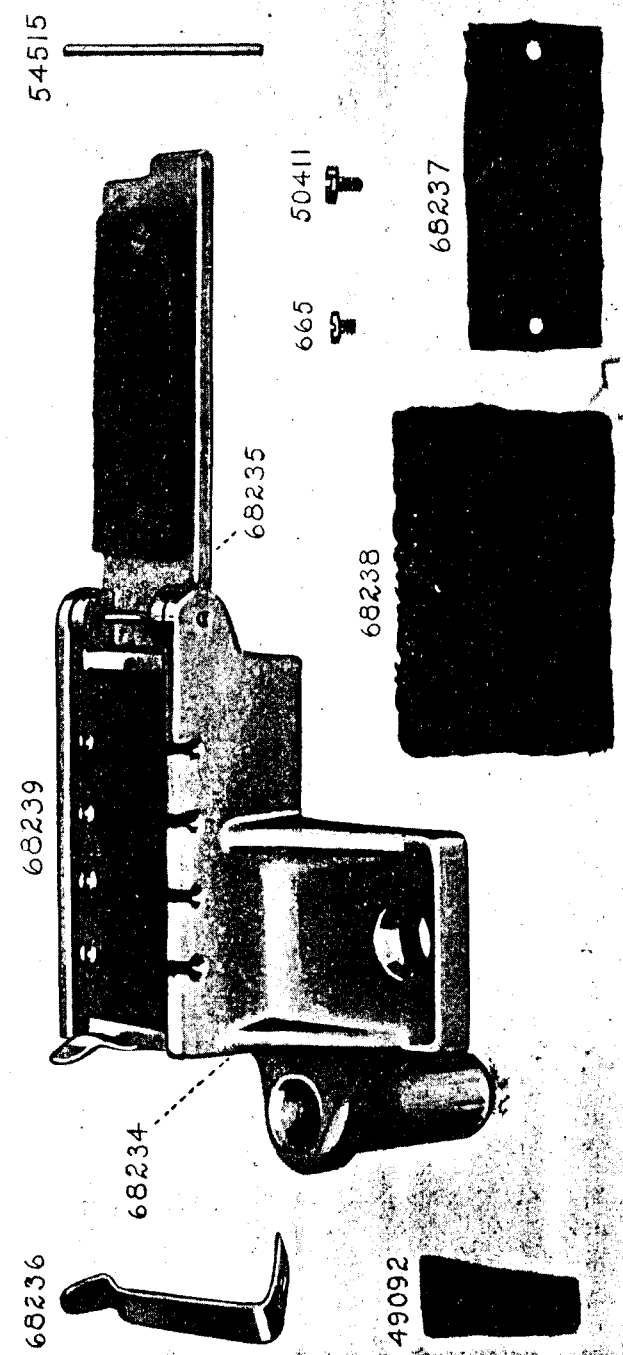

PLATE 9888—FULL SIZE

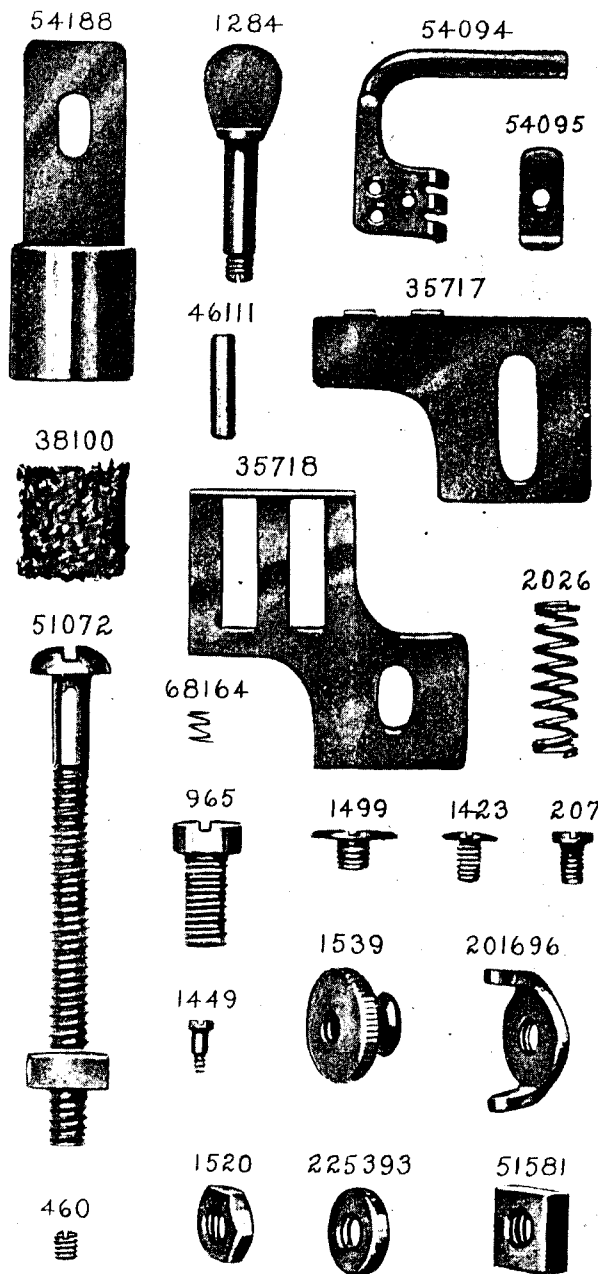

PLATE 9889—ONE-HALF SIZE

