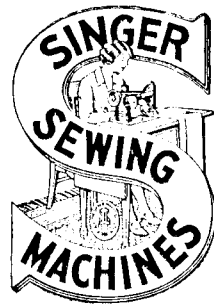


SINGER

149-2,-4

LIST OF PARTS



MACHINES Nos. 149-2 and 149-4

THE SINGER MANUFACTURING COMPANY

INDEX

| | PAGE |
|--|------|
| ACCESSORIES..... | 28 |
| BENCH STAND..... | 32 |
| EDGE FOLDERS..... | 28 |
| FOLDER ON SHANK..... | 29 |
| FOOT LIFTER PARTS..... | 31 |
| KNEE LIFTER PARTS..... | 31 |
| LAP SEAM FELLERS..... | 30 |
| MACHINE BASE WITH BELT GUARD..... | 28 |
| MACHINE No. 149-2..... | 7 |
| “ “ 149-4..... | 18 |
| NUMERICAL LIST OF PARTS..... | 37 |
| OBsolete PARTS..... | 34 |
| STRIP FOLDERS..... | 29 |
| TAPE HOLDERS..... | 32 |
| THREAD UNWINDER (FOR FOUR SPOOLS)..... | 33 |
| “ “ (FOR EIGHT SPOOLS)..... | 34 |

INSTRUCTIONS FOR ORDERING

In ordering from this list, use **ONLY** the part NUMBER in the **FIRST** column.

The number stamped on a Sewing Machine part is in every case the number of the single part only.

Every combination of parts sent out as such has its specific number, which, although not stamped on the parts, must be used when ordering the combination.

Each number always indicates the **SAME PART** in whatever list it appears, or for whatever machine.

The letters after some of the numbers indicate the style of finish only, as follows:

- A—Hardened, Polished, Nickel Plated and Buffed
- B—Polished, Nickel Plated and Buffed
- C—Hardened Only
- D—Polished Only
- E—Soft, Not Polished
- F—Hardened and Polished
- H—Blued
- J—Nickel Plated Only
- K—Hardened and Nickel Plated
- L—Brass Plated
- M—Oxidized
- P—Japanned
- R—Merlized
- T—Copper Plated
- T. A.—Hardened, Polished, Copper and Nickel Plated and Buffed.
- T. B.—Copper and Nickel Plated and Polished.
- T. J.—Copper and Nickel Plated Only.
- T. K.—Hardened, Copper and Nickel Plated.
- T. M.—Copper Plated and Oxidized.
- T. L.—Copper and Brass Plated.
- U—Zinc Plated
- V—Silver Plated
- W—Polished and Nickel Plated
- Z—Chromium Plated

These letters **MUST BE USED** when they appear in the list; and **AFTER** the number **as** in the list.

In this series:

- 1 to 1500 and 50001 to 51500 are Screw Numbers.
- 1501 to 1800 and 51501 to 51800 are Nut Numbers.
- 1801 to 2000 and 51801 to 52000 are Roller Numbers.
- 2001 to 50000 and 52001 and upward are numbers of Machine Parts.

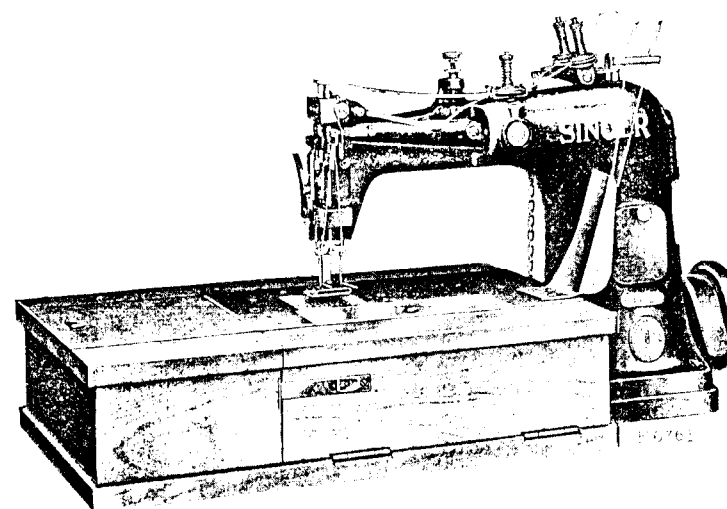
The figures in the second column refer only to the plates, illustrating the parts, and are **NOT TO BE USED** in ordering.

Parts marked with an asterisk (*) are furnished only when repairs are made at factory.

When ordering parts which differ as to **Gauge** (the distance between seams) the Gauge, as well as the **Number must be given** on order.

LIST OF PARTS COMPLETE

FOR



MACHINE No. 149-2

FOR STITCHING FACINGS AND BUTTON STAYS ON MEN'S SHIRTS. SLEEVE SETTING, AND FOR TWO-LINE, TWO-THREAD CHAIN STITCHING IN LIGHT AND MEDIUM WEIGHT FABRICS. TWO NEEDLES, TWO LOOPERS. GAUGES FROM $\frac{3}{16}$ TO $1\frac{1}{2}$ INCHES. SPEED UP TO 3500, ACCORDING TO THE MATERIAL BEING STITCHED.

| NO. | PLATE | NAME |
|--------|-------|---|
| 128632 | --- | Arm, upper and lower (solid) |
| 128502 | 9451 | “ Back Cover |
| 1900 | 9465 | “ “ “ Sewer |
| 128502 | 9451 | “ Side Cover |
| 2860 | 9467 | “ “ “ Thumb Screw |
| 128503 | 9452 | “ Rotary Shaft |
| 128613 | --- | “ “ “ 128503 with 509Ee and 128559 |
| 128664 | --- | Arm Rotary Shaft 128613 with 128663 |
| 128504 | 9451 | “ “ “ Ball Bearing |
| 128505 | 9451 | “ “ “ “ “ Case |
| 128627 | --- | “ “ “ “ “ “ 128505 with 128504, 128506 and three 205E |

| NO. | PLATE | NAME |
|--------|-------|--|
| 128506 | 9451 | Arm Rotary Shaft Ball Bearing Case Cap with 128619 |
| 128619 | 9462 | Arm Rotary Shaft Ball Bearing Case Cap Pad (felt) |
| 205f | 9465 | Arm Rotary Shaft Ball Bearing Case Cap Screw |
| 308c | 9467 | Arm Rotary Shaft Ball Bearing Case Cap Set Screw |
| 54007 | 9451 | Arm Rotary Shaft Bushing (intermediate) |
| 54089 | — | “ “ “ “ “ “ 54007 with 64508 and 64805 |
| 64508 | 9462 | Arm Rotary Shaft Bushing (intermediate) Oil Pad (braided cotton) long |
| 64805 | 9462 | Arm Rotary Shaft Bushing (intermediate) Oil Pad (braided cotton) short |
| 888c | 9466 | Arm Rotary Shaft Bushing (intermediate) Set Screw |
| 128507 | 9456 | Arm Rotary Shaft Bushing (front) |
| 50999c | 9465 | “ “ “ “ “ Set Screw |
| 128508 | 9454 | Arm Rotary Shaft Collar with two 1258c |
| 1258c | 9466 | “ “ “ “ Set Screw |
| 49013 | 9462 | “ “ “ Front Bearing Oil Pad (braided cotton) |
| 128509 | 9451 | Balance Wheel, 2 in. pulley, with two 430c |
| 128510 | 9451 | “ “ Cover |
| 144r | 9467 | “ “ “ Screw |
| 430c | 9466 | “ “ Set Screw |
| 128633 | 9452 | Cloth Plate |
| 128513 | 9462 | “ “ Oil Tube with 49092, for oiling 128520 |
| 49092 | 9462 | Cloth Plate Oil Tube Packing (felt) |
| 128514 | 9452 | “ “ Slide |
| 38416 | 9456 | “ “ “ Spring |
| 725j | 9465 | “ “ “ “ Screw |
| 128515 | — | Cloth Plate Slide complete, Nos. 128514, two 38416 and four 725j |
| 128634 | — | Cloth Plate complete, Nos. 128513, 128515, 128633 and two 4198c |
| 4011f | 9465 | Cloth Plate Screw (left) |
| 50473f | 9465 | “ “ “ (right) |
| 128635 | 9453 | Feed Bar with two 453c |
| 128636 | — | “ “ 128635 with 128519 and two 190b |
| 128707 | — | Feed Bar 128636 with 57225 and 128533 |
| 57225 | 9453 | “ “ Hinge Pin |
| 453c | 9466 | “ “ “ “ Set Screw |

| NO. | PLATE | NAME |
|--------|-------|--|
| 12366 | 9462 | Feed Bar Oil Pad (braided cotton) |
| 128518 | 9455 | “ “ Wearing Block |
| 128519 | 9454 | “ “ “ Plate |
| 190b | 9465 | “ “ “ “ Screw |
| 128520 | 9453 | “ Connection (forked) with 453c and 769c |
| 128615 | — | Feed Connection 128520 with 4095r, 128522, 128528, 128532 and two 128524 |
| 769c | 9465 | Feed Connection Clamping Screw |
| 453c | 9466 | “ “ Set Screw |
| 128524 | 9455 | “ “ Slide Block Section |
| 128522 | 9455 | “ “ “ “ Sleeve |
| 4095f | 9465 | “ “ “ “ “ Cap Screw |
| 128772 | 9469 | Feed Dog, 19 teeth (16 teeth to the inch) with 452c; for 1/4 in. to 7/8 in. gauges |
| 128729 | 9470 | Feed Dog, 19 teeth (16 teeth to the inch) with 452c; for 1/2 in. to 1 1/8 in. gauges |
| 128716 | 9471 | Feed Dog, 19 teeth (16 teeth to the inch) with 452c; for 3/4 in. to 7/8 in. gauges |
| 128726 | 9472 | Feed Dog, 19 teeth (16 teeth to the inch) with 452c; for 1 1/8 in. to 1 1/2 in. gauges |
| 128731 | 9473 | Feed Dog, 19 teeth (16 teeth to the inch) with 452c; for 1 3/8 in. to 1 3/4 in. gauges |
| 128824 | 9474 | Feed Dog, 19 teeth (16 teeth to the inch) with 452c; for 1 3/4 in. to 1 7/8 in. gauges |
| 452c | 9466 | Feed Dog Adjusting Screw |
| 457b | 9465 | “ “ Screw |
| 128638 | 9454 | “ Lifting Eccentric with two 452c |
| 452c | 9466 | “ “ “ Set Screw |
| 50944c | 9467 | “ Regulating Screw |
| 128526 | 9455 | “ “ “ Plate |
| 391d | 9465 | “ “ “ “ Screw |
| 128527 | 9455 | “ Regulator with two 443c |
| 128528 | — | Feed Regulator complete, Nos. 391d, 399b, 50944c, 128526, 128527, 128530 and 128534 |
| 128529 | 9457 | Feed Regulator Bushing |
| 50999b | 9465 | “ “ “ Set Screw |
| 4403b | 9462 | “ “ Oil Pad (felt) |
| 443c | 9467 | “ “ Set Screw |
| 128530 | 9455 | “ “ Slide Block |
| 128531 | 9455 | “ “ “ “ Stop |
| 399b | 9465 | “ “ “ “ “ Screw |
| 128532 | 9455 | “ “ “ “ Washer |
| 128533 | 9453 | “ Rocking Frame with two each 453c and 4324c |

| NO. | PLATE | NAME |
|---------|-------|--|
| 1324c | 9467 | Feed Rocking Frame Adjusting Screw |
| 128534 | 9453 | " " " Hinge Pin |
| 57235 | 9456 | " " " " " Bushing |
| 453c | 9466 | " " " " " " " |
| | | Set Screw |
| 453c | 9466 | Feed Rocking Frame Hinge Pin Set Screw |
| 128717 | 9455 | Looper (closed eye) |
| 128640 | 9455 | " Carrier with two 50379c |
| 128660 | --- | " " 128640 with 228b and 128643 |
| 128537 | 9455 | Looper Carrier Driver |
| *128538 | --- | " " " Connection |
| 128630 | --- | " " " " 128538 with two 128539 and four 896c |
| 128621 | 9455 | Looper Carrier Driver Connection complete, Nos. 128630, 128631 and two 142c |
| 128663 | --- | Looper Carrier Driver Connection 128621 with 128537, 128543 to 128547 and 128641 |
| *128539 | --- | Looper Carrier Driver Connection Cap |
| 896E | 9465 | " " " " " " |
| | | Screw |
| *128540 | --- | Looper Carrier Driver Connection End Bearing |
| 128631 | --- | Looper Carrier Driver Connection End Bearing 128540 with 128541 |
| *128541 | --- | Looper Carrier Driver Connection End Bearing Cap |
| 142E | 9465 | Looper Carrier Driver Connection End Bearing Cap Screw |
| 128641 | 9455 | Looper Carrier Driver Eccentric with 791c and two 452c |
| 791c | 9466 | Looper Carrier Driver Eccentric Position Screw |
| 452c | 9466 | Looper Carrier Driver Eccentric Set Screw |
| 128543 | 9454 | Looper Carrier Holder with two 896c |
| 896E | 9465 | " " " Clamping Screw |
| 128544 | 9453 | " " Rock Shaft |
| 128545 | 9453 | " " " " Hinge Pin |
| 443c | 9466 | " " " " " " " |
| | | Set Screw |
| 128546 | 9454 | Looper Carrier Rock Shaft Nut |
| 128547 | 9454 | " " " " " Clamp with 175b |

| NO. | PLATE | NAME |
|---------|-------|--|
| 175b | 9465 | Looper Carrier Rock Shaft Nut Clamp Screw |
| 898c | 9465 | Looper Carrier Screw |
| 128728 | 9454 | " Eccentric with two 51137c |
| 128665 | --- | " " 128728 with 1664c, 50942c, 128549, 128624 and two 55545 |
| 51137c | 9466 | Looper Eccentric Set Screw |
| 128549 | 9454 | " " Sleeve |
| 128550 | 9454 | " " " Connection with 128552 and two 175E |
| 128624 | --- | Looper Eccentric Sleeve Connection 128550 with 679c |
| 679c | 9454 | Looper Eccentric Sleeve Connection Ball Screw Stud |
| 452b | 9454 | Looper Eccentric Sleeve Connection Ball Screw Stud Nut |
| 128551 | 9454 | Looper Eccentric Sleeve Connection Ball Screw Stud Nut Lock Washer |
| *128552 | --- | Looper Eccentric Sleeve Connection Cap |
| 175E | 9465 | " " " " " " |
| | | Screw |
| 50942E | 9467 | Looper Eccentric Sleeve Connection Hinge Screw |
| 1664E | 9466 | Looper Eccentric Sleeve Connection Hinge Screw Nut |
| 55545 | 9462 | Looper Eccentric Sleeve Connection Oil Hole Packing (braided cotton) |
| 50379E | 9465 | Looper Set Screw |
| 128643 | 9455 | " Thread Guide |
| | | NOTE: When ordering No. 128643, state gauge required. |
| 228b | 9465 | Looper Thread Guide Screw |
| 57244 | 9456 | Needle Bar (hollow) |
| 128766 | --- | " " 57244 with 128767 |
| 38456 | 9456 | " " Bushing (lower) |
| 1133E | 9466 | " " " " Set Screw |
| 128554 | 9456 | " " " (upper) |
| 1133E | 9466 | " " " " Set Screw |
| 128555 | 9456 | " " Connecting Bracket with 1057b, 50370b and 50379E |
| 128713 | --- | Needle Bar Connecting Bracket 128555 with 128556 and 128557 |
| 1057b | 9465 | Needle Bar Connecting Bracket Clamping Screw |
| 128556 | 9456 | Needle Bar Connecting Link |
| 128557 | 9456 | " " " " Hinge Pin |

| NO. | PLATE | NAME |
|---------|-------|---|
| 50370b | 9465 | Needle Bar Connecting Link Hinge Pin Set Screw..... |
| 128558 | 9452 | Needle Bar Lever with 50282c, 50370b and two 1259c..... |
| 128618 | --- | Needle Bar Lever 128558 with 128557 and 128713..... |
| 50943c | 9456 | Needle Bar Lever Ball Screw Stud..... |
| 1259c | 9466 | " " " " " " Set Screw..... |
| 128559 | 9463 | Needle Bar Lever Connecting Rod with 683e, 51897, 128560, 128561, 128628 and four 896e..... |
| *128560 | --- | Needle Bar Lever Connecting Rod Cap (lower)..... |
| 896e | 9465 | Needle Bar Lever Connecting Rod Cap (lower) Screw..... |
| *128561 | --- | Needle Bar Lever Connecting Rod Cap (upper)..... |
| 896e | 9465 | Needle Bar Lever Connecting Rod Cap (upper) Screw..... |
| 42077 | 9456 | Needle Bar Lever Connecting Rod Cap Guide..... |
| 171e | 9465 | Needle Bar Lever Connecting Rod Cap Guide Screw..... |
| 51897 | 9456 | Needle Bar Lever Connecting Rod Cap Oil Cup..... |
| 128628 | 9462 | Needle Bar Lever Connecting Rod Cap Oil Pad (braided cotton)..... |
| 683e | 9465 | Needle Bar Lever Connecting Rod Cap Oil Pad Stop Screw..... |
| 128562 | 9453 | Needle Bar Lever Hinge Pin..... |
| 128563 | 9456 | " " " " " " Bushing (back)..... |
| 443c | 9466 | Needle Bar Lever Hinge Pin Bushing (back) Set Screw..... |
| 128564 | 9456 | Needle Bar Lever Hinge Pin Bushing (front)..... |
| 743c | 9466 | Needle Bar Lever Hinge Pin Bushing (front) Set Screw..... |
| 51648 | 9462 | Needle Bar Lever Hinge Pin Bushing (front) Oil Pad (braided cotton)..... |
| 50282e | 9465 | Needle Bar Lever Set Screw..... |
| 128767 | 9456 | " Clamp with two 50379e..... |
| 50379e | 9465 | " Set Screw..... |
| *128567 | --- | Oil Cup for 128568..... |
| 128569 | 9463 | " " Pad (felt)..... |
| *128570 | --- | " " Tube..... |

| NO. | PLATE | NAME |
|--------|-------|---|
| 128571 | 9462 | Oil Cup Tube Wick (braided cotton)..... |
| 128568 | 9463 | Oil Cup complete, for oiling 128550, Nos. 128567 and 128569 to 128571..... |
| 792e | 9465 | Oil Cup Screw for 128568..... |
| 128572 | " " | " " for 128573..... |
| 128574 | " " | " " Bracket..... |
| 41006 | 9463 | " " Pad (felt)..... |
| 128575 | " " | " " Tube (long)..... |
| 128576 | " " | " " (short)..... |
| 128574 | 9462 | " " " Wick (braided cotton)..... |
| 128573 | 9463 | Oil Cup complete, for oiling 128538, Nos. 41006, 128572, 128574 to 128576 and two 128571..... |
| 1239e | 9465 | Oil Cup Screw for 128573..... |
| 128577 | " " | " Tube for 128725..... |
| 49092 | 9462 | " " Packing (felt)..... |
| 128725 | 9463 | " " Bracket and Thread Guide with 49092 and 128577..... |
| 61477 | 9457 | Presser Bar with 25303..... |
| 25303 | 9457 | " " Ball, size 1/4 in..... |
| 61046 | 9457 | " " Bushing (lower)..... |
| 1133E | 9466 | " " " " " Set Screw..... |
| 38456 | 9456 | " " " (upper)..... |
| 1133E | 9466 | " " " " " Set Screw..... |
| 128580 | 9457 | " " Guide Bracket with 175c and 154c..... |
| 175c | 9465 | Presser Bar Guide Bracket Adjusting Screw..... |
| 128581 | 9457 | Presser Bar Guide Bracket Guide..... |
| 157c | 9466 | " " " " " " Set Screw..... |
| 154c | 9466 | Presser Bar Guide Bracket Set Screw..... |
| 128582 | 9457 | " " Lifter..... |
| 57258 | 9457 | " " " Hinge Stud..... |
| 443c | 9466 | " " " " " " Set Screw..... |
| 51871 | 9457 | " " " Roller and Stud..... |
| 50603e | 9467 | " " " Stop Screw..... |
| 128583 | 9457 | " " Lifting Bracket with 465c and 51871..... |
| 128584 | 9452 | Presser Bar Lifting Lever..... |
| 61075 | 9457 | " " " " " Connecting Stud..... |
| 465c | 9466 | Presser Bar Lifting Lever Connecting Stud Set Screw..... |
| 802b | 9466 | Presser Bar Lifting Lever Hinge Screw..... |
| 54040 | 9464 | " " Spring (flat)..... |
| 38468 | 9457 | " " " Stud..... |

| NO. | PLATE | NAME |
|--------|-------|---|
| 128733 | 9468 | Presser Foot Extension with two 62527 |
| 128734 | 9468 | " " " Connection |
| 1145D | 9468 | " " " " |
| | | Hinge Screw..... |
| 62527 | 9468 | Presser Foot Extension Hinge Pin..... |
| 18055 | 9468 | " " Hinge Pin..... |
| 128735 | ----- | " " Plate..... |
| 128647 | ----- | " " Shank with 563J and 1700J |
| 563J | 9468 | " " " Adjusting Screw.... |
| 1700J | 9468 | " " " " " Nut |
| 2656 | 9468 | " " Spring..... |
| 128736 | 9468 | Presser Foot (hinged extension and hinged plate) complete, for obtaining a smooth finish on broadcloth shirt centres, Nos. 18055, 128647, 128733, 128735 and two each 1145D, 2656 and 128734..... |
| 18055 | 9468 | Presser Foot Hinge Pin..... |
| 128718 | ----- | " " Plate..... |
| 128647 | ----- | " " Shank with 563J and 1700J |
| 563J | 9468 | " " " Adjusting Screw.... |
| 1700J | 9468 | " " " " " Nut |
| 128719 | 9468 | Presser Foot (hinged) complete, for shirt centres, Nos. 18055, 128647 and 128718..... |
| 190D | 9465 | Presser Foot Screw..... |
| 574W | 9467 | Pressure Regulating Thumb Screw..... |
| 1539W | 9467 | " " " " Lock Nut..... |
| 128587 | 9461 | Slack Thread Controller..... |
| 46035 | 9461 | " " " Clamp..... |
| 176D | 9465 | " " " " Screw.... |
| 128720 | 9461 | " " Regulator..... |
| 128589 | 9461 | " " " Holder with 452C..... |
| 128590 | 9461 | Slack Thread Regulator Holder Crank with 175D..... |
| 175D | 9465 | Slack Thread Regulator Holder Crank Clamping Screw..... |
| 128591 | 9461 | Slack Thread Regulator Holder Crank Driver with 456C and 1963..... |
| 1963 | 9461 | Slack Thread Regulator Holder Crank Driver Roller and Stud..... |
| 456C | 9466 | Slack Thread Regulator Holder Crank Driver Set Screw..... |
| 452C | 9466 | Slack Thread Regulator Set Screw..... |

| NO. | PLATE | NAME |
|--------|-------|---|
| 128649 | 9461 | Tension (under thread) Bracket..... |
| 997E | 9465 | " " " " Screw |
| 50944E | 9467 | " " " " Stud..... |
| 2102 | 9461 | Tension (under thread) Disc..... |
| 1560C | 9466 | " " " Regulating Thumb Nut..... |
| 916C | 9467 | Tension (under thread) Screw Stud.... |
| 44209 | ----- | " " " " " " 916C with 1560C..... |
| 10148 | 9461 | Tension (under thread) Spring..... |
| 17547 | 9461 | " " " Thread Guide.. |
| 128592 | 9451 | " (upper thread) Bracket..... |
| 376D | 9465 | " " " " Screw.. |
| 2102 | 9461 | " " " Disc..... |
| 51570C | 9466 | " " " Regulating Thumb Nut..... |
| 32572 | 9461 | Tension (upper thread) Releasing Disc |
| 54988 | 9461 | " " " " Pin.. |
| 54989 | 9461 | " " " " Shaft |
| 54872 | 9461 | " " " " " " |
| | | Crank with 624C..... |
| 128593 | 9461 | Tension (upper thread) Releasing Shaft Crank Connecting Link..... |
| 110D | 9465 | Tension (upper thread) Releasing Shaft Crank Connecting Link Hinge Screw |
| 624C | 9466 | Tension (upper thread) Releasing Shaft Crank Set Screw..... |
| 54990 | 9459 | Tension (upper thread) Releasing Shaft Spring..... |
| 316C | 9466 | Tension (upper thread) Releasing Shaft Stop Screw..... |
| 1547J | 9466 | Tension (upper thread) Releasing Shaft Stop Screw Nut..... |
| 50326C | 9467 | Tension (upper thread) Screw Stud.... |
| 59539 | ----- | Tension (upper thread) Screw Stud 50326C with 51570C..... |
| 59535 | 9459 | Tension (upper thread) Spring..... |
| 59537 | 9459 | " " " " Bushing (large)..... |
| 59538 | 9459 | Tension (upper thread) Spring Bushing (small)..... |
| 17547 | 9461 | Tension (upper thread) Thread Guide.. |
| 128650 | 9459 | Thread (under) Eyelet..... |
| 1521J | 9466 | " " " Nut..... |
| 128774 | 9459 | " " Guide (left) for $\frac{3}{16}$ in. to $\frac{5}{16}$ in. gauges..... |

| NO. | PLATE | NAME |
|--------|-------|--|
| 128651 | 9459 | Thread (under) Guide (left) for $\frac{3}{8}$ in. to $1\frac{1}{2}$ in. gauges..... |
| | NOTE: | When ordering Nos. 128651 or 128774, state gauge required. |
| 128775 | 9459 | Thread (under) Guide (right) for $\frac{3}{16}$ in. to $\frac{5}{8}$ in. gauges..... |
| 128652 | 9459 | Thread (under) Guide (right) for $\frac{3}{8}$ in. to $1\frac{1}{2}$ in. gauges..... |
| | NOTE: | When ordering Nos. 128652 or 128775 state gauge required. |
| 128653 | 9459 | Thread (under) Guide Holder..... |
| 446c | 9466 | " " " " Set Screw |
| 176d | 9465 | " " " Screw for 128651 and 128652..... |
| 185d | 9465 | Thread (under) Guide Screw for 128774 and 128775..... |
| 128654 | 9463 | Thread (under) Protector..... |
| 1235f | 9465 | " " " Screw..... |
| 46009 | 9459 | " (upper) Eyelet..... |
| 128721 | 9459 | " " " for 128558..... |
| 190d | 9465 | " " " Screw..... |
| 50945c | 9467 | " " " " Stud for 46009..... |
| 2102 | 9461 | Thread (upper) Nipper Disc..... |
| 51570c | 9466 | " " " Regulation Thumb Nut..... |
| 128604 | 9459 | Thread (upper) Nipper Regulator..... |
| 190d | 9465 | " " " " Adjusting Screw..... |
| 32572 | 9461 | Thread (upper) Nipper Releasing Disc |
| 128605 | 9459 | " " " " Pin |
| 51029c | 9467 | " " " Screw Stud |
| 128714 | --- | " " " " " " 51029c with 51570c..... |
| 128656 | 9459 | Thread (upper) Nipper Spring |
| 59537 | 9459 | " " " " Bushing (large)..... |
| 59538 | 9459 | Thread (upper) Nipper Spring Bushing (small)..... |
| 128606 | 9459 | Thread (upper) Nipper Thread Guide... |
| 128722 | 9459 | " " Take-up..... |
| 50379f | 9465 | " " " Set Screw... |
| 128773 | 9469 | Throat Plate with 128724 and two 665d, for 128772..... |
| 128730 | 9470 | Throat Plate with 128724 and two 665d, for 128729..... |

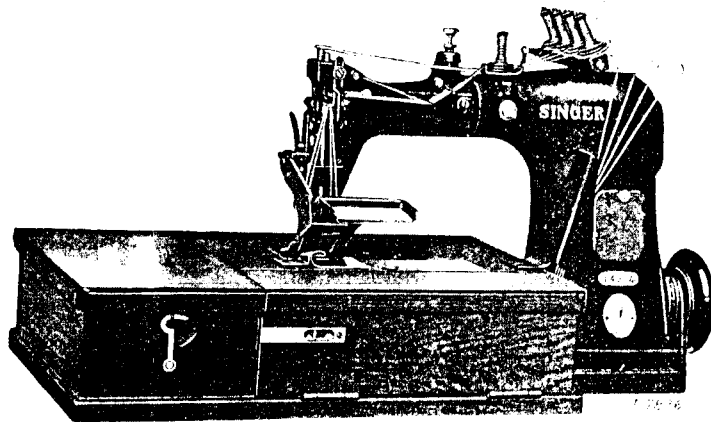
| NO. | PLATE | NAME |
|--------|-------|--|
| 128723 | 9471 | Throat Plate with 128724 and two 665d, for 128716..... |
| 128737 | 9475 | Throat Plate with 128724 and two 665d, for 128736, for 128716..... |
| 128727 | 9472 | Throat Plate with 128724 and two 665d, for 128726..... |
| 128770 | 9475 | Throat Plate with 128724 and two 665d, for obtaining a smooth finish on broad-cloth shirt centres, for 128726..... |
| 128732 | 9473 | Throat Plate with 128724 and two 665d, for 128731..... |
| 128822 | 9474 | Throat Plate with 128724 and two 665d, for 128821..... |
| 128612 | 9463 | Throat Plate Holder..... |
| 50154d | 9465 | " " " Screw..... |
| 1011f | 9465 | " " Screw..... |
| 1198c | 9465 | " " Supporting Screw..... |
| 128724 | 9472 | " " Thread Retainer for 128723, 128727, 128730, 128732, 128737, 128770, 128773 and 128822..... |
| | NOTE: | When ordering No. 128724 state gauge required. |
| 665d | 9465 | Throat Plate Thread Retainer Screw... |

Genuine Singer Needles and their Containers are marked with the Company's Trade Mark "SIMANCO." 1

Needles in Containers marked "For Singer Machines" are not Singer made needles. 2

LIST OF PARTS COMPLETE

FOR



MACHINE No. 149-4

FOR STITCHING CENTRES ON MEN'S SHIRTS AND OTHER WORK IN FABRICS REQUIRING FOUR-ROW STITCHINGS, FOUR NEEDLES AND FOUR LOOPERS. THE GREATEST DISTANCE BETWEEN THE OUTSIDE NEEDLES IS $1\frac{1}{2}$ INCHES, WHICH CAN BE DIVIDED INTO SMALLER GAUGES BETWEEN EACH NEEDLE AS ORDERED, EXCEPT THAT NONE CAN BE MADE SMALLER THAN $\frac{3}{16}$ INCH. SPEED UP TO 3400, ACCORDING TO THE MATERIAL BEING STITCHED.

| NO. | PLATE | NAME |
|---------|-------|---|
| *128632 | — | Arm, upper and lower (solid)..... |
| 128502 | 9451 | " Back Cover..... |
| 190b | 9465 | " " " Screw..... |
| 128502 | 9451 | " Side Cover..... |
| 286b | 9467 | " " " Thumb Screw..... |
| 128503 | 9452 | " Rotary Shaft..... |
| 128613 | — | " " " 128503 with 50943c and 128559..... |
| 128664 | — | Arm Rotary Shaft 128613 with 128663 |
| 128504 | 9451 | " " " Ball Bearing..... |
| 128505 | 9451 | " " " " " Case |
| 128627 | — | " " " " " " |
| | | 128505 with 128504, 128506 and three 205F..... |

PARTS FOR MACHINE No. 149-4

| NO. | PLATE | NAME |
|--------|-------|--|
| 128506 | 9451 | Arm Rotary Shaft Ball Bearing Case Cap with 128619..... |
| 128619 | 9462 | Arm Rotary Shaft Ball Bearing Case Cap Pad (felt)..... |
| 205F | 9465 | Arm Rotary Shaft Ball Bearing Case Cap Screw..... |
| 30Sc | 9467 | Arm Rotary Shaft Ball Bearing Case Cap Set Screw..... |
| 54007 | 9451 | Arm Rotary Shaft Bushing (intermediate) |
| 54089 | — | " " " " " " |
| | | 54007 with 64508 and 64805..... |
| 64508 | 9462 | Arm Rotary Shaft Bushing (intermediate) Oil Pad (braided cotton) long..... |
| 64805 | 9462 | Arm Rotary Shaft Bushing (intermediate) Oil Pad (braided cotton) short..... |
| 88Sc | 9466 | Arm Rotary Shaft Bushing (intermediate) Set Screw..... |
| 128507 | 9456 | Arm Rotary Shaft Bushing (front)..... |
| 50999c | 9465 | " " " " " Set Screw..... |
| 128508 | 9454 | Arm Rotary Shaft Collar with two 1258c |
| 1258c | 9466 | " " " " Set Screw.... |
| 49013 | 9462 | " " " Front Bearing Oil Pad (braided cotton)..... |
| 128509 | 9451 | Balance Wheel, 2 in. pulley, with two 430c |
| 128510 | 9451 | " " Cover..... |
| 144r | 9467 | " " " Screw..... |
| 430c | 9466 | " " Set Screw..... |
| 128633 | 9452 | Cloth Plate..... |
| 128513 | 9462 | " " Oil Tube with 49092, for oil- ing 128520..... |
| 49092 | 9462 | Cloth Plate Oil Tube Packing (felt)..... |
| 128514 | 9452 | " " Slide..... |
| 38416 | 9456 | " " " Spring..... |
| 725j | 9465 | " " " " Screw..... |
| 128515 | — | Cloth Plate Slide complete, Nos. 128514, two 38416 and four 725j..... |
| 128634 | — | Cloth Plate complete, Nos. 128513, 128515, 128633 and two 119Sc..... |
| 1011r | 9465 | Cloth Plate Screw (left)..... |
| 50473F | 9465 | " " " (right)..... |
| 128635 | 9453 | Feed Bar with two 453c..... |
| 128636 | — | " " 128635 with 128519 and two 190b..... |
| 128707 | — | Feed Bar 128636 with 57225 and 128533 |
| 57225 | 9453 | " " Hinge Pin..... |
| 453c | 9466 | " " " " Set Screw..... |

| NO. | PLATE | NAME |
|--------|-------|--|
| 42366 | 9462 | Feed Bar Oil Pad (braided cotton)..... |
| 128518 | 9455 | “ “ Wearing Block..... |
| 128519 | 9454 | “ “ “ Plate..... |
| 190D | 9465 | “ “ “ “ Screw..... |
| 128520 | 9453 | “ Connection (forked) with 453c and 769c..... |
| 128615 | — | Feed Connection 128520 with 1095F, 128522, 128528, 128532 and two 128521 |
| 769c | 9465 | Feed Connection Clamping Screw..... |
| 453c | 9466 | “ “ Set Screw..... |
| 128521 | 9455 | “ “ Slide Block Section.... |
| 128522 | 9455 | “ “ “ “ Sleeve.... |
| 1095F | 9465 | “ “ “ “ “ Cap Screw..... |
| 128738 | 9476 | Feed Dog, 19 teeth (16 teeth to the inch) with 452c, for $\frac{3}{16}$ in. to $\frac{1}{4}$ in., $\frac{7}{8}$ in. to $1\frac{1}{8}$ in. and $\frac{3}{16}$ in. to $\frac{1}{4}$ in. gauges.... |
| 452c | 9466 | Feed Dog Adjusting Screw..... |
| 157D | 9465 | “ “ Screw..... |
| 128638 | 9454 | “ Lifting Eccentric with two 452c.... |
| 452c | 9466 | “ “ “ Set Screw..... |
| 50941c | 9467 | “ Regulating Screw..... |
| 128526 | 9455 | “ “ “ Plate..... |
| 391D | 9465 | “ “ “ “ Screw.... |
| 128527 | 9455 | “ Regulator with two 1143c..... |
| 128528 | — | Feed Regulator complete, Nos. 391D, 399D, 50941c, 128526, 128527, 128530 and 128531..... |
| 128529 | 9457 | Feed Regulator Bushing..... |
| 50999D | 9465 | “ “ “ Set Screw..... |
| 41036 | 9462 | “ “ Oil Pad (felt)..... |
| 1143c | 9467 | “ “ Set Screw..... |
| 128530 | 9455 | “ “ Slide Block..... |
| 128531 | 9455 | “ “ “ “ Stop..... |
| 399D | 9465 | “ “ “ “ “ Screw |
| 128532 | 9455 | “ “ “ “ Washer ... |
| 128533 | 9453 | “ Rocking Frame with two each 453c and 1324c..... |
| 1324c | 9467 | Feed Rocking Frame Adjusting Screw... .. |
| 128534 | 9453 | “ “ “ “ Hinge Pin..... |
| 57235 | 9456 | “ “ “ “ “ Bushing |
| 453c | 9466 | “ “ “ “ “ “ Set Screw..... |
| 453c | 9466 | Feed Rocking Frame Hinge Pin Set Screw |
| 128768 | 9458 | Looper (self threading) with 590D, 61011 and 128702..... |

| NO. | PLATE | NAME |
|---------|-------|---|
| 128739 | 9458 | Looper Carrier with four 50379F..... |
| 128769 | — | “ “ “ “ 128739 with 228D and 128740..... |
| 128537 | 9455 | Looper Carrier Driver..... |
| *128538 | — | “ “ “ “ Connection..... |
| 128630 | — | “ “ “ “ “ 128538 with two 128539 and four 896E..... |
| 128621 | 9455 | Looper Carrier Driver Connection complete, Nos. 128630, 128631 and two 142E..... |
| 128663 | — | Looper Carrier Driver Connection 128621 with 128537, 128543 to 128547 and 128641..... |
| *128539 | — | Looper Carrier Driver Connection Cap |
| 896E | 9465 | “ “ “ “ “ “ Screw..... |
| *128540 | — | Looper Carrier Driver Connection End Bearing..... |
| 128631 | — | Looper Carrier Driver Connection End Bearing 128540 with 128541..... |
| *128541 | — | Looper Carrier Driver Connection End Bearing Cap..... |
| 142E | 9465 | Looper Carrier Driver Connection End Bearing Cap Screw..... |
| 128641 | 9455 | Looper Carrier Driver Eccentric with 791c and two 452c..... |
| 791c | 9466 | Looper Carrier Driver Eccentric Position Screw..... |
| 452c | 9466 | Looper Carrier Driver Eccentric Set Screw..... |
| 128543 | 9454 | Looper Carrier Holder with two 896E.... |
| 896E | 9465 | “ “ “ Clamping Screw |
| 128544 | 9453 | “ “ “ Rock Shaft..... |
| 128545 | 9453 | “ “ “ “ “ Hinge Pin... .. |
| 443c | 9466 | “ “ “ “ “ “ “ Set Screw..... |
| 128546 | 9454 | Looper Carrier Rock Shaft Nut..... |
| 128547 | 9454 | “ “ “ “ “ “ Clamp with 175D..... |
| 175D | 9465 | Looper Carrier Rock Shaft Nut Clamp Screw..... |
| 898c | 9465 | Looper Carrier Screw..... |
| 128728 | 9454 | “ Eccentric with two 51137c..... |
| 128665 | — | “ “ “ “ 128728 with 1664E, 50942c, 128549, 128624 and two 55545 |
| 51137c | 9466 | Looper Eccentric Set Screw..... |
| 128549 | 9454 | “ “ “ Sleeve..... |

| NO. | PLATE | NAME |
|--|-------|---|
| 128550 | 9454 | Looper Eccentric Sleeve Connection with 128552 and two 175E..... |
| 128624 | --- | Looper Eccentric Sleeve Connection 128550 with 679c..... |
| 679c | 9454 | Looper Eccentric Sleeve Connection Ball Screw Stud..... |
| 1520j | 9454 | Looper Eccentric Sleeve Connection Ball Screw Stud Nut..... |
| 128551 | 9454 | Looper Eccentric Sleeve Connection Ball Screw Stud Nut Lock Washer..... |
| *128552 | --- | Looper Eccentric Sleeve Connection Cap 175E 9465 |
| 50942E | 9467 | Looper Eccentric Sleeve Connection Hinge Screw..... |
| 1664E | 9466 | Looper Eccentric Sleeve Connection Hinge Screw Nut..... |
| 55515 | 9462 | Looper Eccentric Sleeve Connection Oil Hole Packing (braided cotton)..... |
| 50379F | 9465 | Looper Set Screw..... |
| 128702 | 9458 | " Thread Guard..... |
| 61041 | 9458 | " " " Pin..... |
| 590D | 9458 | " " " Screw..... |
| 128740 | 9458 | " " Guide..... |
| NOTE: When ordering No. 128740, state gauge required | | |
| 228D | 9465 | Looper Thread Guide Screw..... |
| 57244 | 9456 | Needle Bar (hollow)..... |
| 61181 | --- | " " 57244 with 61094..... |
| 38456 | 9456 | " " Bushing (lower)..... |
| 1133E | 9466 | " " " " Set Screw.. |
| 128554 | 9456 | " " " " (upper)..... |
| 1133E | 9466 | " " " " Set Screw.. |
| 128555 | 9456 | " " Connecting Bracket with 1057D, 50370D and 50379F..... |
| 128713 | --- | Needle Bar Connecting Bracket 128555 with 128556 and 128557..... |
| 1057D | 9465 | Needle Bar Connecting Bracket Clamping Screw..... |
| 128556 | 9456 | Needle Bar Connecting Link..... |
| 128557 | 9456 | " " " " Hinge Pin |
| 50370D | 9465 | " " " " " " Set Screw..... |
| 128558 | 9452 | Needle Bar Lever with 50282E, 50370D and two 1259c..... |

| NO. | PLATE | NAME |
|---------|-------|---|
| 128618 | --- | Needle Bar Lever 128558 with 128557 and 128713..... |
| 50943c | 9456 | Needle Bar Lever Ball Screw Stud..... |
| 1259c | 9466 | " " " " " " Set Screw..... |
| 128559 | 9463 | Needle Bar Lever Connecting Rod with 683F, 54897, 128560, 128561, 128628 and four 896E..... |
| *128560 | --- | Needle Bar Lever Connecting Rod Cap (lower)..... |
| 896E | 9465 | Needle Bar Lever Connecting Rod Cap (lower) Screw..... |
| *128561 | --- | Needle Bar Lever Connecting Rod Cap (upper)..... |
| 896E | 9465 | Needle Bar Lever Connecting Rod Cap (upper) Screw..... |
| 42077 | 9456 | Needle Bar Lever Connecting Rod Guide 171E 9465 |
| 54897 | 9456 | Needle Bar Lever Connecting Rod Oil Cup..... |
| 128628 | 9462 | Needle Bar Lever Connecting Rod Oil Pad (braided cotton)..... |
| 683F | 9465 | Needle Bar Lever Connecting Rod Oil Pad Stop Screw..... |
| 128562 | 9453 | Needle Bar Lever Hinge Pin..... |
| 128563 | 9456 | " " " " " Bushing (back)..... |
| 443C | 9466 | Needle Bar Lever Hinge Pin Bushing (back) Set Screw..... |
| 128564 | 9456 | Needle Bar Lever Hinge Pin Bushing (front)..... |
| 743c | 9466 | Needle Bar Lever Hinge Pin Bushing (front) Set Screw..... |
| 54648 | 9462 | Needle Bar Lever Hinge Pin Bushing (front) Oil Pad (braided cotton)..... |
| 50282E | 9465 | Needle Bar Lever Set Screw..... |
| 61094 | 9458 | " Clamp with four 50014F..... |
| 50014F | 9466 | " Set Screw..... |
| *128567 | --- | Oil Cup for 128568..... |
| 128569 | 9463 | " " Pad (felt)..... |
| *128570 | --- | " " Tube..... |
| 128571 | 9462 | " " " Wick (braided cotton).... |
| 128568 | 9463 | Oil Cup complete, for oiling 128550, Nos. 128567 and 128569 to 128571..... |
| 792c | 9465 | Oil Cup Screw for 128568..... |
| *128572 | --- | " " for 128573..... |

| NO. | PLATE | NAME |
|---------|-------|---|
| *128574 | — | Oil Cup Bracket..... |
| 44006 | 9463 | “ “ Pad (felt)..... |
| *128575 | — | “ “ Tube (long)..... |
| *128576 | — | “ “ “ (short)..... |
| 128571 | 9462 | “ “ “ Wick (braided cotton).... |
| 128573 | 9463 | Oil Cup complete, for oiling 128538, Nos. 44006, 128572, 128574 to 128576 and two 128571..... |
| 1239F | 9465 | Oil Cup Screw for 128573..... |
| *128577 | — | “ Tube for 128741..... |
| 49092 | 9462 | “ “ Packing (felt)..... |
| 128741 | 9463 | “ “ Bracket and Thread Guide with 49092 and 128577..... |
| 61477 | 9457 | Presser Bar with 25303..... |
| 25303 | 9457 | “ “ Ball, size $\frac{1}{4}$ in..... |
| 61046 | 9457 | “ “ Bushing (lower)..... |
| 1133E | 9466 | “ “ “ “ Set Screw.. |
| 38456 | 9456 | “ “ “ (upper)..... |
| 1133E | 9466 | “ “ “ “ Set Screw.. |
| 128580 | 9457 | “ “ Guide Bracket with 175c and 454c..... |
| 175c | 9465 | Presser Bar Guide Bracket Adjusting Screw..... |
| 128581 | 9457 | Presser Bar Guide Bracket Guide..... |
| 457c | 9466 | “ “ “ “ “ “ Set Screw..... |
| 454c | 9466 | Presser Bar Guide Bracket Set Screw.. |
| 128582 | 9457 | “ “ Lifter..... |
| 57258 | 9457 | “ “ “ Hinge Stud..... |
| 443c | 9466 | “ “ “ “ “ Set Screw |
| 51871 | 9457 | “ “ “ Roller and Stud..... |
| 50603E | 9467 | “ “ “ Stop Screw..... |
| 128583 | 9457 | “ “ Lifting Bracket with 465c and 51871..... |
| 128584 | 9452 | Presser Bar Lifting Lever..... |
| 61075 | 9457 | “ “ “ “ Connecting Stud..... |
| 465c | 9466 | Presser Bar Lifting Lever Connecting Stud Set Screw..... |
| 802b | 9466 | Presser Bar Lifting Lever Hinge Screw.. |
| 128742 | 9464 | “ “ “ “ Spring..... |
| 54040 | 9464 | “ “ Spring (flat)..... |
| 38468 | 9457 | “ “ “ Stud..... |
| 18055 | 9468 | “ Foot Hinge Pin..... |
| 128743 | — | “ “ Plate..... |
| 128647 | — | “ “ Shank with 563J and 1700J |

| NO. | PLATE | NAME |
|--------|-------|---|
| 563J | 9468 | Presser Foot Shank Adjusting Screw.. |
| 1700J | 9468 | “ “ “ “ “ Nut |
| 128741 | 9468 | Presser Foot (hinged) complete, Nos. 18055, 128647 and 128743..... |
| 190b | 9465 | Presser Foot Screw..... |
| 571w | 9467 | Pressure Regulating Thumb Screw..... |
| 4539w | 9467 | “ “ “ “ Lock Nut..... |
| 128745 | 9460 | Slack Thread Controller..... |
| 54242 | 9460 | “ “ “ Clamp..... |
| 190b | 9465 | “ “ “ “ Screw.. |
| 128746 | 9460 | “ “ Regulator..... |
| 128589 | 9461 | “ “ “ Holder with 452c. |
| 128590 | 9461 | “ “ “ “ Crank with 175b..... |
| 175b | 9465 | Slack Thread Regulator Holder Crank Clamping Screw..... |
| 128591 | 9461 | Slack Thread Regulator Holder Crank Driver with 456c and 1963..... |
| 1963 | 9461 | Slack Thread Regulator Holder Crank Driver Roller and Stud..... |
| 456c | 9466 | Slack Thread Regulator Holder Crank Driver Set Screw..... |
| 452c | 9466 | Slack Thread Regulator Set Screw..... |
| 2102 | 9461 | Tension (under thread) Disc..... |
| 128747 | 9458 | “ “ “ Post..... |
| 1620b | 9466 | “ “ “ “ Lock Nut |
| 14017 | 9460 | “ “ “ “ “ “ Washer..... |
| 51570c | 9466 | Tension (under thread) Regulating Thumb Nut..... |
| 50326c | 9467 | Tension (under thread) Screw Stud..... |
| 59539 | — | “ “ “ “ “ 50326c with 51570c..... |
| 46386 | 9458 | Tension (under thread) Separating Disc |
| 59531 | 9459 | “ “ “ Spring..... |
| 59537 | 9459 | “ “ “ “ Bushing (large)..... |
| 59538 | 9459 | Tension (under thread) Spring Bushing (small)..... |
| 128748 | 9460 | Tension (under thread) Thread Guide.. |
| 128749 | 9464 | “ (upper thread) Bracket..... |
| 376b | 9465 | “ “ “ “ Screw.. |
| 2102 | 9461 | “ “ “ Disc..... |
| 51570c | 9466 | “ “ “ Regulating Thumb Nut..... |

| NO. | PLATE | NAME |
|--------|-------|---|
| 32572 | 9461 | Tension (upper thread) Releasing Disc. |
| 54988 | 9461 | " " " " Pin... |
| 54246 | 9464 | " " " " Shaft |
| 54872 | 9461 | " " " " " |
| | | Crank with 624c..... |
| 54737 | 9458 | Tension (upper thread) Releasing Shaft Crank Connecting Link..... |
| 110b | 9465 | Tension (upper thread) Releasing Shaft Crank Connecting Link Hinge Screw.. |
| 624c | 9466 | Tension (upper thread) Releasing Shaft Crank Set Screw..... |
| 316c | 9466 | Tension (upper thread) Releasing Shaft Stop Screw..... |
| 1547J | 9466 | Tension (upper thread) Releasing Shaft Stop Screw Nut..... |
| 50326c | 9467 | Tension (upper thread) Screw Stud..... |
| 59539 | --- | " " " " " 50326c with 51570c..... |
| 59535 | 9459 | Tension (upper thread) Spring..... |
| 59537 | 9459 | " " " " Bushing (large)..... |
| 59538 | 9459 | Tension (upper thread) Spring Bushing (small)..... |
| 57076 | 9458 | Tension (upper thread) Thread Guide |
| 128750 | 9460 | Thread (under) Eyelet..... |
| 1521J | 9466 | " " " Nut..... |
| 128654 | 9463 | " " Protector..... |
| 1235F | 9465 | " " " Screw..... |
| 128751 | 9460 | " " Thread Guide, for one thread..... |
| 128752 | 9460 | Thread (under) Thread Guide, for two threads..... |
| 128753 | 9460 | Thread (under) Thread Guide, for three threads..... |
| 128754 | 9460 | Thread (under) Thread Guide, for four threads..... |
| 128755 | 9460 | Thread (under) Thread Guide Holder with four 1498c..... |
| 128756 | 9460 | Thread (under) Thread Guide Holder Post..... |
| 446c | 9466 | Thread (under) Thread Guide Holder Post Set Screw..... |
| 171D | 9465 | Thread (under) Thread Guide Holder Screw..... |
| 1498c | 9466 | Thread (under) Thread Guide Set Screw |

| NO. | PLATE | NAME |
|--------|-------|--|
| 128757 | ---- | Thread (under) Thread Guide complete, Nos. 171D and 128751 to 128756..... |
| | | NOTE: When ordering No. 128757, state gauge required. |
| 128758 | 9460 | Thread (upper) Eyelet..... |
| 128759 | 9460 | " " " " for 128558..... |
| 190b | 9465 | " " " " Screw..... |
| 50945c | 9467 | " " " " Stud..... |
| 2102 | 9461 | " " Nipper Disc..... |
| 51570c | 9466 | " " " " Regulating Thumb Nut..... |
| 128604 | 9459 | Thread (upper) Nipper Regulator..... |
| 190b | 9465 | " " " " Ad- justing Screw..... |
| 32572 | 9461 | Thread (upper) Nipper Releasing Disc.. |
| 128761 | 9460 | " " " " Pin... |
| 51029c | 9467 | " " " " Screw Stud |
| 128714 | - | " " " " " |
| | | 51029c with 51570c..... |
| 46386 | 9458 | Thread (upper) Nipper Separating Disc. |
| 128656 | 9459 | " " " " Spring..... |
| 59537 | 9459 | " " " " Bushing (large)..... |
| 59538 | 9459 | Thread (upper) Nipper Spring Bushing (small)..... |
| 128762 | 9460 | Thread (upper) Nipper Thread Guide.. |
| 128763 | 9460 | " " " Take-up..... |
| 50379F | 9465 | " " " Set Screw..... |
| 128764 | 9476 | Throat Plate with 128765 and two 665D, for 128738..... |
| 128612 | 9463 | Throat Plate Holder..... |
| 50154D | 9465 | " " " " Screw..... |
| 1011F | 9465 | " " " " Screw..... |
| 1198c | 9465 | " " Supporting Screw..... |
| 128765 | 9476 | " " Thread Retainer for 128764 |
| | | NOTE: When ordering No. 128765, state gauge required. |
| 665D | 9465 | Throat Plate Thread Retainer Screw... |

ACCESSORIES

| NO. | PLATE | NAME |
|--------|-------|--|
| 120344 | 8941 | Oiler (copper plated) with 120345 |
| 120345 | 8941 | “ Spout, 5 in. long..... |
| 26026 | 8941 | Screw Driver (large)..... |
| 26485 | 8941 | “ “ (small)..... |
| 128771 | 9464 | Threading Wire, for self threading loopers |
| 120341 | 8941 | Tweezers (curved)..... |
| 4822 | 8941 | Wrench for 1547..... |
| 8908 | 8941 | “ “ 1520..... |
| 19079 | 9462 | “ “ 1324..... |

MACHINE BASE WITH BELT GUARD

| NO. | PLATE | NAME |
|--------|-------|---|
| 54356 | 8980 | Belt Guard with 1192c..... |
| 27347 | 9490 | “ “ Hinge Pin..... |
| 1192c | 9467 | “ “ “ “ Set Screw..... |
| 1192c | 9467 | “ “ Set Screw..... |
| 54357 | 8980 | Machine Base with 1192c..... |
| 51072E | 9466 | “ “ Bolt with 51581E..... |
| 51581E | 9466 | “ “ “ Nut..... |
| 6055 | 8979 | “ “ “ “ Washer..... |
| 49123 | 8979 | “ “ Oil Pipe..... |
| 60884 | 8979 | “ “ “ “ Plug..... |
| 57285 | 8979 | “ Cushion (felt)..... |
| 948E | 9466 | “ Screw, to fasten machine to base |
| 54358 | — | Machine Base with Belt Guard complete, Nos. 27347, 49123, 54356, 54357, 60884, three each 6055, 51072E and four each 948E and 57285..... |

EDGE FOLDERS

| NO. | PLATE | NAME |
|--------|-------|--|
| 120549 | 9485 | Edge Folder on Shank, for turning the right hand edge under, for button or buttonhole facings..... |
| 120640 | 9485 | Edge Folder on Shank (left) for starting from bottom of garment..... |
| 120641 | 9485 | Edge Folder on Shank (right) for starting from neck of garment..... |
| 120547 | 9452 | Cloth Plate Slide..... |
| 38416 | 9456 | “ “ “ Spring..... |
| 725J | 9465 | “ “ “ “ Screw..... |
| 120548 | — | Cloth Plate Slide Complete, Nos. 120547, two 38416 and four 725J..... |
| 1423J | 9465 | Edge Folder Screw..... |

FOLDER ON SHANK

| NO. | PLATE | NAME |
|--------|-------|---|
| 120593 | 9484 | Folder on Shank, for making bluff centres on shirts..... |
| 1423J | 9465 | Folder Screw..... |

STRIP FOLDERS

STRIP FOLDERS ON BRACKET

| NO. | PLATE | NAME |
|--------|-------|--|
| 120633 | — | Strip Folder with left hand interlining guide for 120635..... |
| 120697 | — | Strip Folder with right hand interlining guide for 120698..... |
| 120634 | 9486 | Strip Folder Bracket for 120635, 120637, 120698 and 120703..... |
| 1443J | 9465 | Strip Folder Bracket Screw for 120635, 120637, 120698 and 120703..... |
| 120635 | 9484 | Strip Folder on Bracket with left hand interlining guide complete, for centre work on shirts, Nos. 120633, 120634 and two 1443J..... |
| 120698 | 9486 | Strip Folder on Bracket with right hand interlining guide complete, for centre work on shirts, Nos. 120634, 120697 and two 1443J..... |
| 120636 | — | Strip Folder for 120637..... |
| 120637 | 9486 | Strip Folder on Bracket complete, for buttonhole facings or centre work on shirts, Nos. 120634, 120636 and two 1443J..... |
| 120702 | — | Strip Folder for 120703..... |
| 120703 | 9486 | Strip Folder on Bracket complete, for sleeve plackets, Nos. 120634, 120702 and two 1443J..... |
| 724b | 9465 | Strip Folder Hinge Screw..... |
| 1423J | 9465 | “ “ Screw..... |
| 120638 | 9464 | “ “ Throw-out Arm..... |
| 1377c | 9467 | “ “ “ “ Adjusting Screw (eccentric)..... |
| 1547J | 9466 | Strip Holder Throw-out Arm Adjusting Screw Nut..... |
| 853c | 9466 | Strip Folder Throw-out Arm Adjusting Screw Set Screw..... |
| 120642 | 9464 | Strip Folder Throw-out Arm Bracket with 853c..... |

| NO. | PLATE | NAME |
|--------|-------|---|
| 120639 | 9464 | Strip Folder Throw-out Arm Bracket 120642 with 946d, 1377c, 1517j, 36006, 50152d and 120638, for 120635, 120637, 120698 and 120703. |
| 50152d | 9465 | Strip Folder Throw-out Arm Bracket Screw. |
| 946d | 9467 | Strip Folder Throw-out Arm Hinge Screw. |
| 36006 | 9190 | Strip Folder Throw-out Arm Hinge Screw Washer. |

STRIP FOLDERS ON SHANK

| NO. | PLATE | NAME |
|--------|-------|--|
| 120550 | 9185 | Strip Folder on Shank, for button stays. |
| 120701 | 9487 | “ “ “ “ for under facing strips, for button or buttonhole facings |
| 120699 | 9187 | Strip Folder Strip Guide for 120700. |
| 120700 | 9487 | Strip Folder on Shank with 120699 and two 1423j, for long or short strips, for sleeve or button facings. |
| 1423j | 9465 | Strip Folder Strip Guide Screw for 120700 |
| 120691 | 9188 | Strip Folder on Shank with adjustable guide using strip to fold over and turn- ing in both edges and for inserting body of garment in one operation. |
| 120547 | 9452 | Cloth Plate Slide. |
| 38416 | 9456 | “ “ “ Spring. |
| 725j | 9465 | “ “ “ “ Screw. |
| 120548 | — | Cloth Plate Slide complete, Nos. 120547, two 38416 and four 725j. |
| 1423j | 9465 | Strip Folder Screw. |

LAP SEAM FELLERS

FOR NO. 149-2 MACHINE

| NO. | PLATE | NAME |
|--------|-------|--|
| 120657 | 9483 | Lap Seam Feller on Shank (spring yield- ing) for shirt work. |
| 120704 | 9483 | Lap Seam Feller on Shank with two 1443j, for sleeving. |
| 120705 | 9482 | Feed Dog, 19 teeth (16 teeth to the inch) with 452c, for $\frac{3}{16}$ in. gauge. |
| 120658 | 9481 | Feed Dog, 19 teeth (16 teeth to the inch) with 452c, for $\frac{1}{4}$ in. and $\frac{5}{16}$ in. gauges. |
| 120659 | — | Presser Foot Plate for 120660. |

| NO. | PLATE | NAME |
|--------|-------|--|
| 120660 | 9481 | Presser Foot (hinged) complete, Nos. 18055, 120659 and 128647. |
| 120706 | 9482 | Throat Plate with 128721 and two 665n, for 120705. |
| 120661 | 9481 | Throat Plate with 128724 and two 665n, for 120658. |
| 1443j | 9465 | Lap Seam Feller Screw, to fasten folder to shank, for 120704. |
| 1423j | 9465 | Lap Seam Feller Screw, to fasten shank to slide. |

FOOT LIFTER PARTS

| NO. | PLATE | NAME |
|---|-------|--|
| 6439 | — | Chain, 36 in. to 45 in., with 56864 and 56865. |
| NOTE: When ordering No. 6439, state length required. | | |
| 4879 | 8941 | Chain Connecting Link. |
| 56864 | 8941 | “ Hook (large). |
| 56865 | 9462 | “ “ (small). |
| 126249 | 8980 | Treadle. |
| 4882 | 8941 | “ Shaft. |
| 126250 | 8941 | “ Spring. |
| 126251 | 8980 | “ Stand. |
| 126252 | 8980 | Treadle complete, Nos. 4882, 126249 to 126251 and two wood screws 1 in. No. 16. |

KNEE LIFTER PARTS

| NO. | PLATE | NAME |
|-------|-------|---|
| 37563 | — | Chain, length 15 inches, with 56864 and 56865. |
| 56864 | 8941 | Chain Hook (large). |
| 56865 | 9462 | “ “ (small). |
| 2763 | 8980 | Rock Shaft. |
| 12242 | 8980 | “ “ Hanger with two wood screws 1 in. No. 10. |
| 6335 | 8980 | Rock Shaft Knee Arm. |
| 6336 | — | Rock Shaft Knee Arm complete, Nos. 2766, 2767 and 6335. |
| 2766 | 8980 | Rock Shaft Knee Arm Hub with 356c. |
| 356c | 9467 | “ “ “ “ “ Set Screw. |
| 2767 | 8980 | “ “ “ Plate with 356c. |

| NO. | PLATE | NAME |
|-------|-------|--|
| 356c | 9467 | Rock Shaft Knee Plate Set Screw..... |
| 6337 | 8980 | " " Lifting Bracket with two 356c..... |
| 7125 | 8980 | Rock Shaft Lifting Bracket Hook..... |
| 356c | 9467 | " " " " " " Set Screw..... |
| 356c | 9467 | Rock Shaft Lifting Bracket Set Screw.. |
| 2770 | 8980 | " " Stop Dog with 356c..... |
| 356c | 9467 | " " " " Set Screw..... |
| 23767 | 8980 | Rock Shaft complete, Nos. 2763, 2770, 6336, 6337, 7125 and two 12242..... |

BENCH STAND

| NO. | PLATE | NAME |
|--------|-------|---|
| 79757 | — | Bench Stand with 27998, two each 41538, 124500, three wood screws 1¼ in. No. 14, four 60656, eight wood screws ⅝ in. No. 5 and sixteen wood screws ⅝ in. No. 7..... |
| 124500 | 8952 | Flap Hinge..... |
| 27998 | 8952 | " Hook and Eye (brass) with wood screw 1½ in. No. 5..... |
| 126247 | 8952 | Flush Bolt..... |
| 126248 | 8952 | " " Plate..... |
| 41538 | — | Flush Bolt with Plate complete, Nos. 126247, 126248 and four brass wood screws ⅝ in. No. 4..... |
| 60656 | 8952 | Hinge..... |

TAPE HOLDERS

TAPE HOLDER

| NO. | PLATE | NAME |
|---------|-------|--|
| *120671 | — | Tape Reel Disc..... |
| 120675 | 9489 | " " " 120671 with 120676..... |
| *120676 | — | " " " Hub..... |
| 120677 | 9463 | " " " Screw Stud..... |
| 120678 | 9489 | " " Rod..... |
| 138B | 9465 | " " " Set Screw..... |
| 27618 | 9489 | " " Stand with 138B..... |
| 120679 | 9489 | " " Tape Guide..... |
| 120682 | 9489 | " " " " Bracket with 446c and 448c..... |
| 446c | 9466 | Tape Reel Tape Guide Bracket Set Screw |
| 448c | 9466 | " " " " Set Screw..... |

| NO. | PLATE | NAME |
|--------|-------|---|
| 120681 | 9489 | Tape Holder, 9 in. disc, complete, for interlining centering work, Nos. 27618, 120675, 120677 to 120679, 120682 and three wood screws 1¼ in. No. 12..... |

TAPE HOLDER

FOR UNDER THE BENCH

| NO. | PLATE | NAME |
|---------|-------|--|
| *120671 | — | Tape Reel Disc..... |
| 120672 | 9489 | " " " 120671 with 120673..... |
| *120673 | — | " " " Hub..... |
| 120674 | 9489 | " " Rod..... |
| 28012 | 9490 | " " Screw Eye..... |
| 120680 | 9489 | Tape Holder, 9 in. disc, complete, for under the bench, Nos. 28012, 120672 and 120674..... |

THREAD UNWINDER

FOR FOUR SPOOLS, FOR NO. 149-2 MACHINE

| NO. | PLATE | NAME |
|---------|-------|--|
| 225395 | 8953 | Spool Rest (for two spools) with 201018c |
| 225388 | 8953 | " " Rod..... |
| 200383c | 9467 | " " " Set Screw..... |
| 201018c | 9467 | " " Set Screw..... |
| 202490 | 8953 | " Stand with 200383c..... |
| 225391 | 8953 | Thread Guide..... |
| 201696d | 9467 | " " Lock Nut..... |
| 225392 | 8953 | " " Rod with 208E and 225393 |
| 208E | 9465 | " " " Screw..... |
| 225393 | 9467 | " " " Washer..... |
| 225398 | 8953 | Thread Unwinder complete, Nos. 201696d, 202490, 225388, 225392, two 225395, four 225391 and three wood screws 7⁄8 in. No. 12..... |
| 27739 | 9464 | Thread Cone (wood), for large cones... |
| 225390 | — | " " Holder, for inverted cones |

NOTE: Nos. 27739 and 225390 are used with,
but not included in 225398

THREAD UNWINDER

FOR EIGHT SPOOLS, FOR NO. 149-4 MACHINE

| NO. | PLATE | NAME |
|---------|-------|--|
| 27623 | 7931 | Spool Pin..... |
| 155c | 9465 | “ “ Set Screw..... |
| 41534 | 7931 | “ Rest..... |
| 41535 | — | “ “ 41534 with 4149c and four each 155c and 27623..... |
| 1149c | 9465 | Spool Rest Set Screw..... |
| 202490 | 7931 | “ Stand with 200383c..... |
| 27739 | 7931 | Thread Cone (wood)..... |
| 41633 | 7931 | “ Guard with 208E and four 41569..... |
| 41569 | 9458 | “ “ Eyelet..... |
| 41638 | 7931 | “ “ Rod..... |
| 60300 | 7931 | “ “ “ Connection with two 453c..... |
| 453c | 9466 | Thread Guard Rod Connection Set Screw..... |
| 200383c | 9467 | “ “ “ Set Screw..... |
| 208E | 9465 | “ “ Screw..... |
| 41635 | 9490 | “ “ Tension Bracket with 175D..... |
| 175D | 9465 | “ “ “ “ Set Screw..... |
| 41636 | — | Thread Guard Tension Bracket complete, Nos. 418D, 1562J, 41635, 43808 and two 2455..... |
| 2455 | 9458 | Thread Guard Tension Disc..... |
| 418D | 9467 | “ “ “ Screw Stud..... |
| 1562J | 9466 | “ “ “ “ “ Regulating Thumb Nut..... |
| 43808 | 9490 | Thread Guard Tension Spring..... |
| 60301 | 7931 | Thread Unwinder complete, Nos. 60300, 202490, two each 41535, 41633, 41638, three wood screws 1 in. No. 12 and eight each 27739 and 41636..... |

OBSOLETE PARTS

FOR MACHINE NO. 149-2

| NO. | PLATE | NAME |
|--------|-------|---|
| 128637 | 9477 | Feed Dog, 19 teeth (16 teeth to the inch) with 452c, for $\frac{1}{4}$ in. to 1 in. gauges.. |
| 128661 | 9478 | Feed Dog, 19 teeth (16 teeth to the inch) with 452c, for $1\frac{1}{16}$ in. to $1\frac{1}{4}$ in. gauges.. |
| 128700 | 9479 | Feed Dog, 19 teeth (16 teeth to the inch) with 452c, for $\frac{1}{2}$ in. to $\frac{5}{8}$ in. gauges.. |
| 128705 | 9480 | Feed Dog, 19 teeth (16 teeth to the inch) with 452c, for $1\frac{3}{8}$ in. to $1\frac{1}{2}$ in. gauges.. |

| NO. | PLATE | NAME |
|---------|-------|---|
| 128639 | 9490 | Looper (closed eye)..... |
| 128642 | 9490 | “ Eccentric with two 889c, use 128728..... |
| 889c | 9466 | Looper Eccentric Set Screw..... |
| 128553 | — | Needle Bar 57244 with 128565, use 128766..... |
| 128565 | 9490 | Needle Clamp with 128566, 128620 and two each 460E and 620E, use 128767.. |
| 128566 | 9490 | Needle Clamp Thread Guide (left)..... |
| 620E | 9466 | “ “ “ “ “ Screw..... |
| 128620 | 9490 | “ “ “ “ “ (right)..... |
| 620E | 9466 | “ “ “ “ “ Screw..... |
| 460E | 9466 | “ Set Screw..... |
| 54108 | — | Oil Tube..... |
| 128644 | — | “ “ and Thread Guide Bracket..... |
| 128645 | 9464 | Oil Tube and Thread Guide Bracket complete, Nos. 49092, 54108, 128644 and 128657, use 128725..... |
| 128646 | — | Presser Foot Plate for 128648..... |
| 128648 | 9490 | Presser Foot (hinged) complete, Nos. 18055, 128646 and 128647, use 128719..... |
| 128588 | 9490 | Slack Thread Regulator..... |
| 128655 | 9490 | Thread (upper) Eyelet for 128558..... |
| *128657 | — | “ “ Guide for 128645..... |
| 128610 | 9490 | “ “ Take-up..... |
| 54095 | 9490 | “ “ “ Thread Retainer..... |
| 1449n | 9467 | Thread (upper) Take-up Thread Retainer Screw..... |
| 54716 | 9458 | Thread (upper) Take-up Thread Retainer Spring..... |
| 128658 | 9477 | Throat Plate with 128659 and two 665D, for 128637..... |
| 128662 | 9478 | Throat Plate with 128659 and two 665D, for 128661..... |
| 128701 | 9479 | Throat Plate with 128659 and two 665D, for 128700..... |
| 128706 | 9480 | Throat Plate with 128659 and two 665D, for 128705..... |
| 128659 | 9479 | Throat Plate Thread Retainer for 128658, 128662, 128701 and 128706..... |

PLATE 7931—ONE-SIXTH SIZE

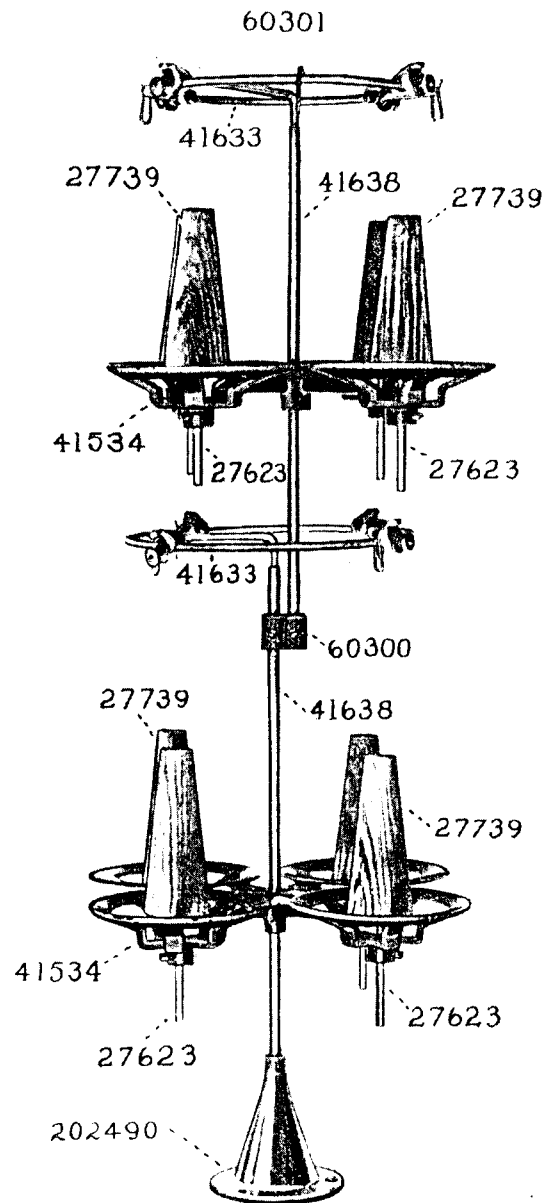


PLATE 8941—ONE-HALF SIZE

19221 8908 120344 26485 38487

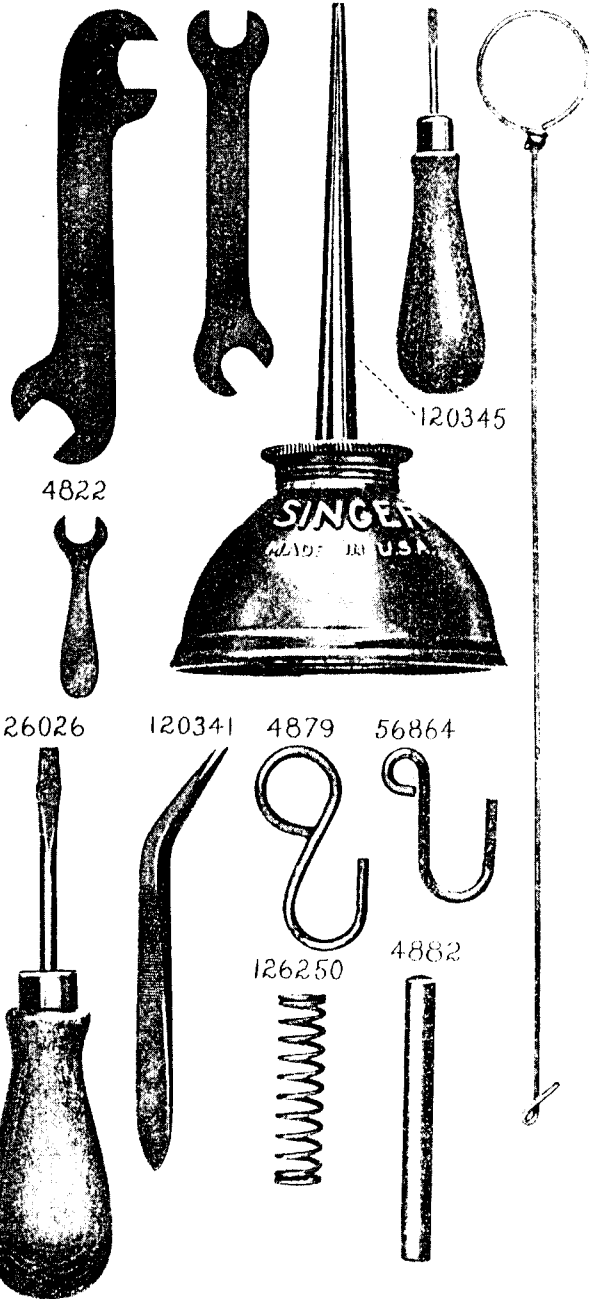


PLATE 8952—FULL SIZE

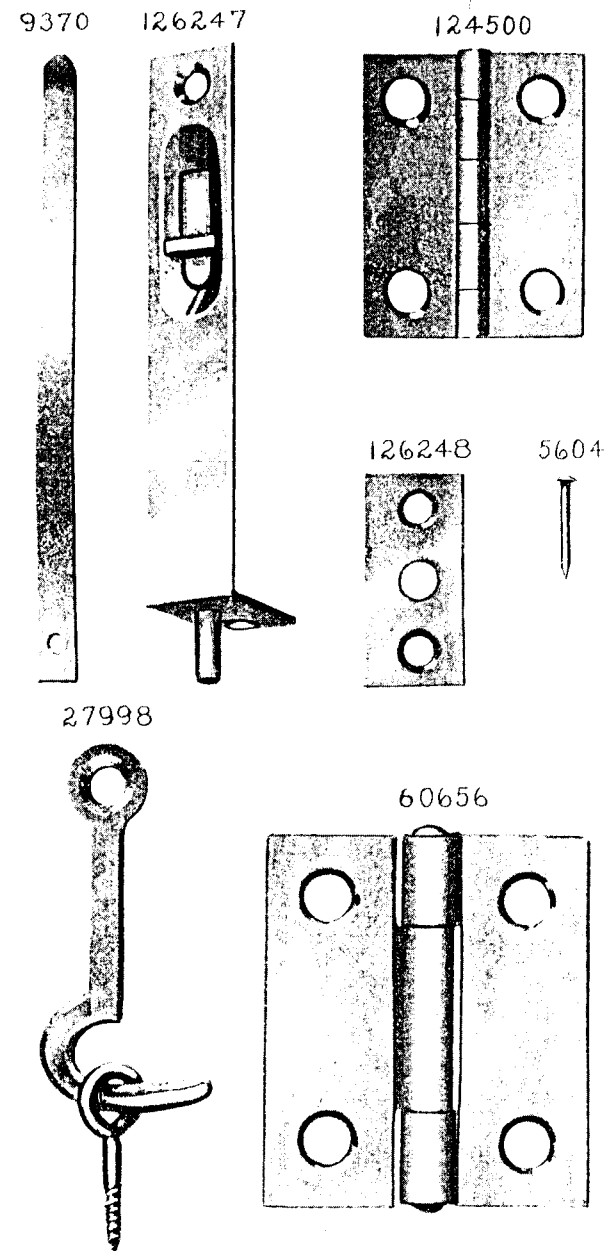


PLATE 8953—ONE-SIXTH SIZE

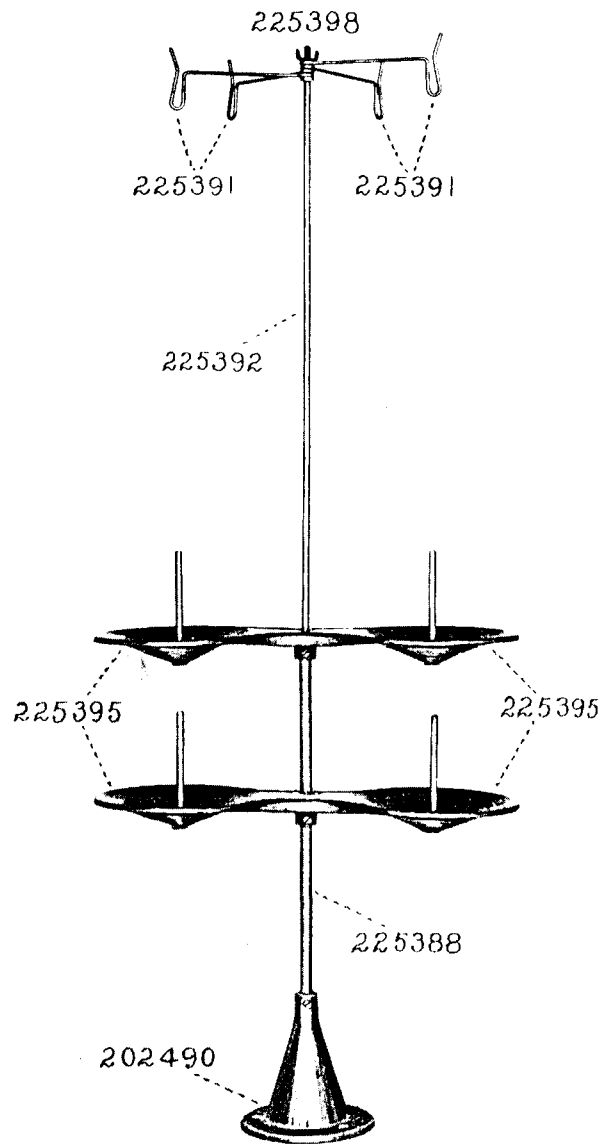


PLATE 8979—FULL SIZE

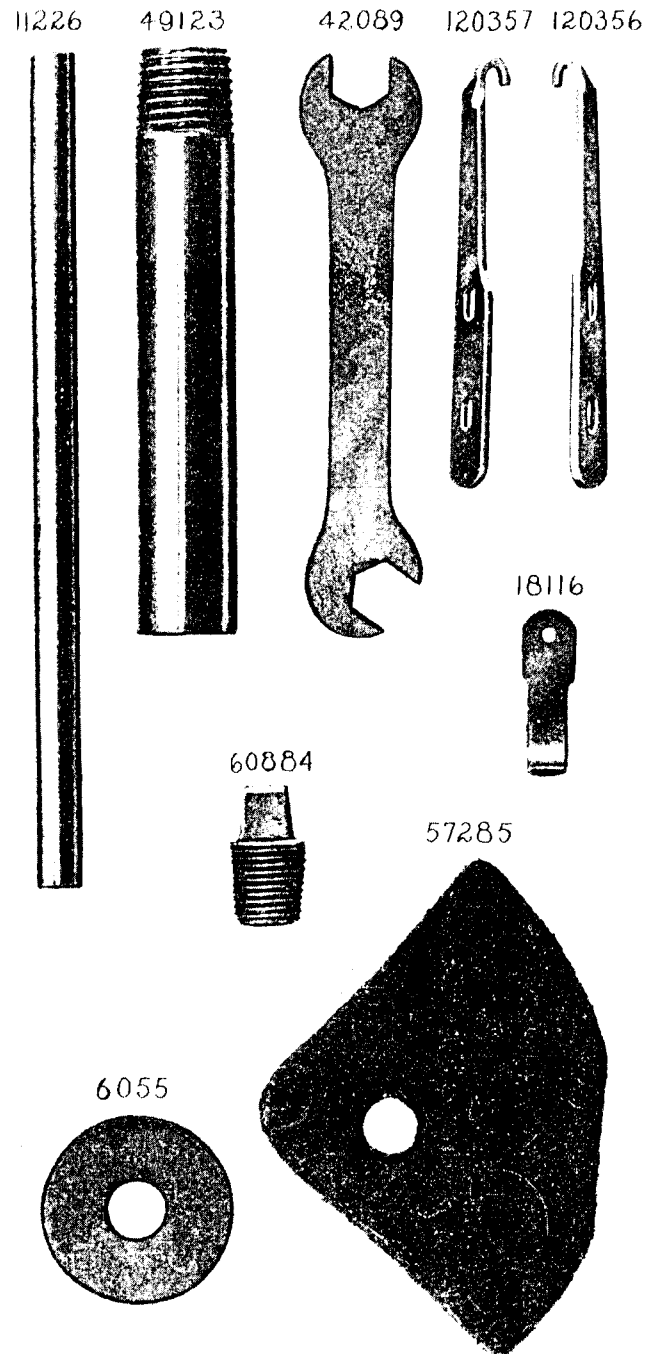


PLATE 8980—ONE-FOURTH SIZE

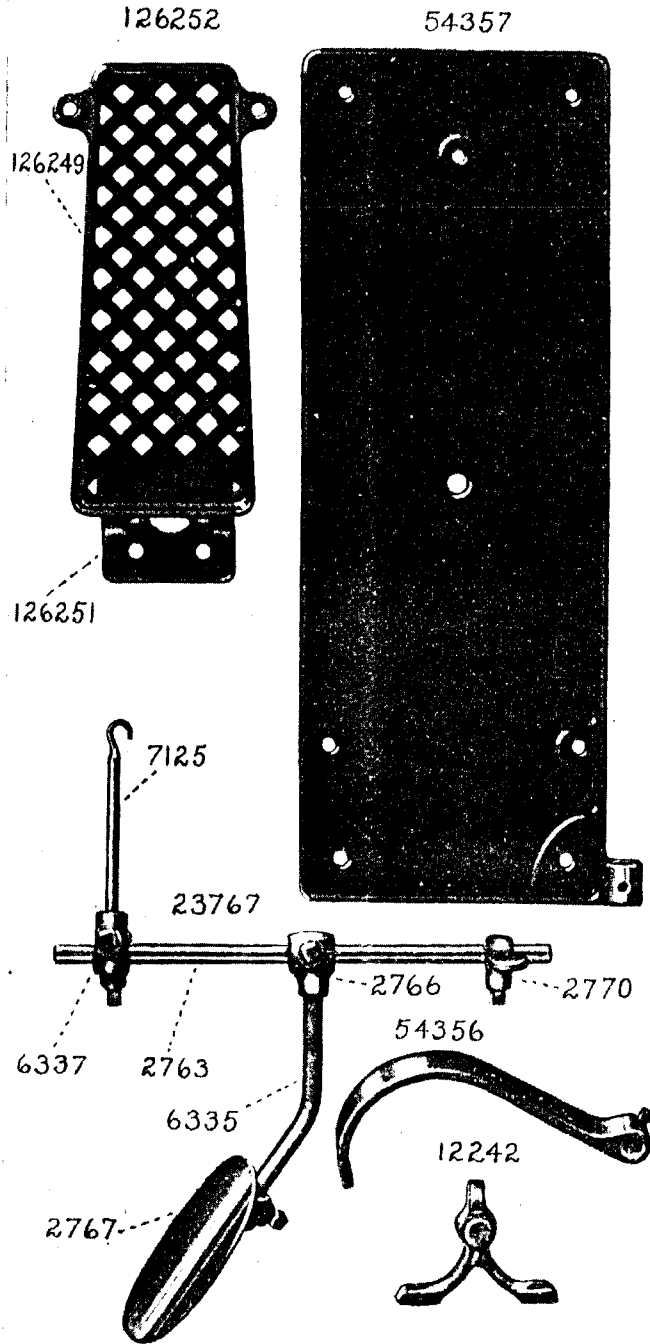


PLATE 9451—ONE-HALF SIZE

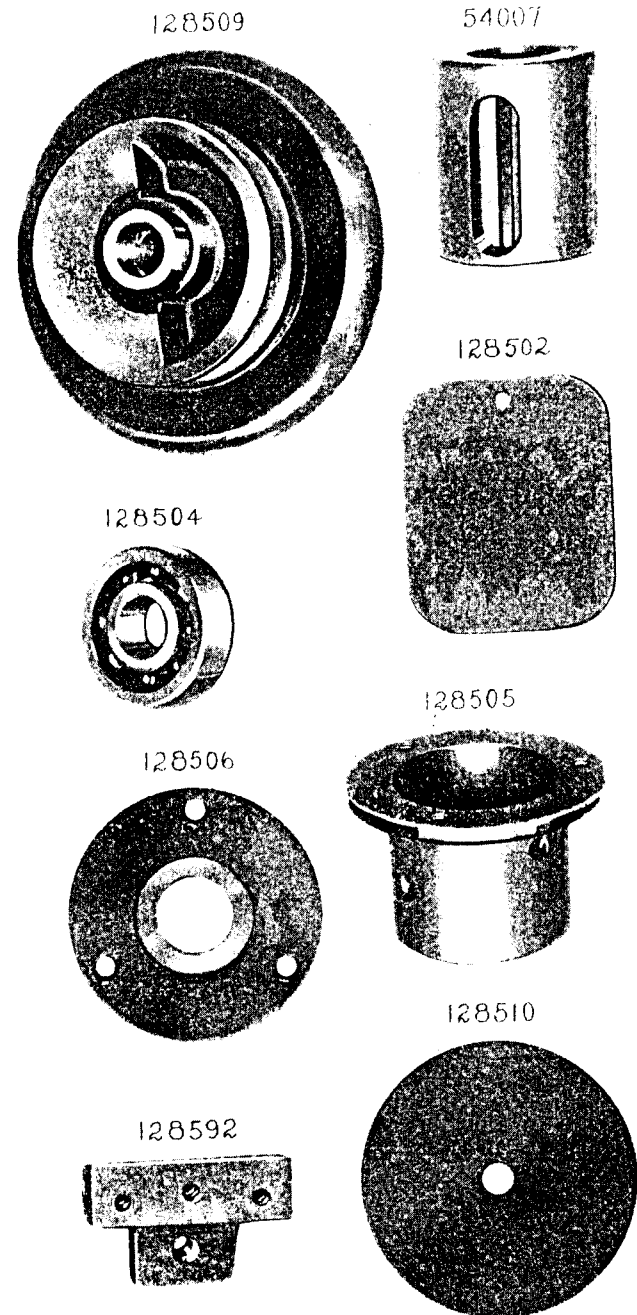


PLATE 9452—ONE-FOURTH SIZE

128503



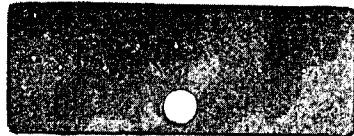
128584



128558



128514



120547



128633

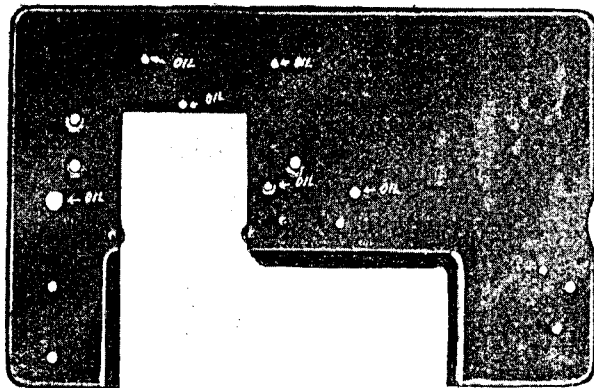
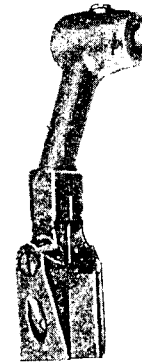


PLATE 9453—ONE-HALF SIZE

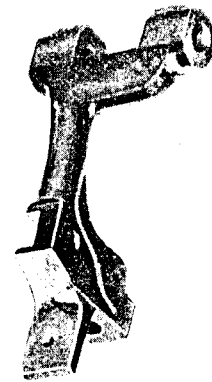
57225



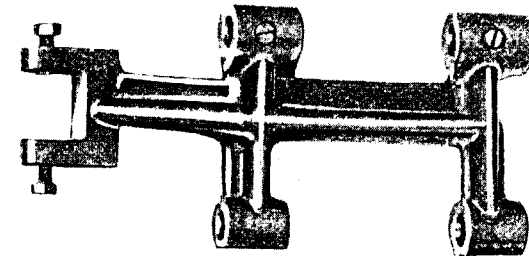
128520



128635



128533



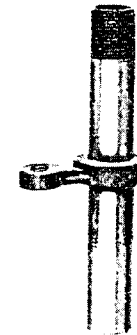
128534



128545



128544

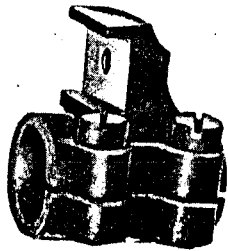


128562

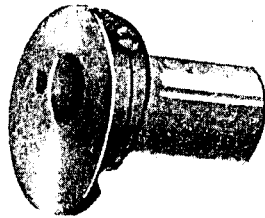


PLATE 9454—FULL SIZE

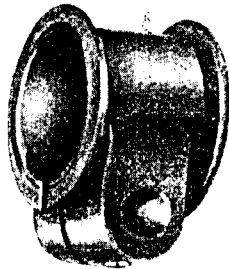
128543



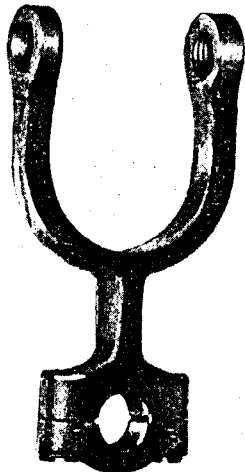
128638



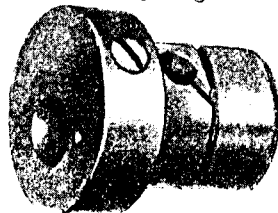
128549



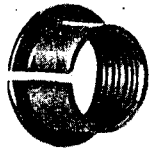
128550



128728



128546



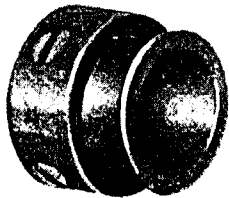
128547



679



128508



128519



128551

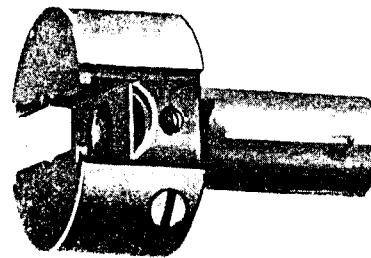


1520

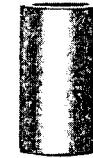


PLATE 9455—FULL SIZE

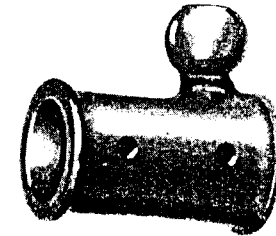
128527



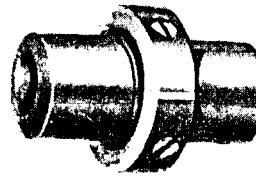
128522



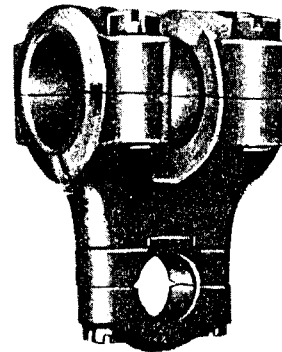
128537



128641



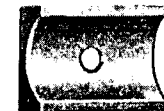
128621



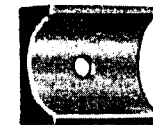
128526



128521



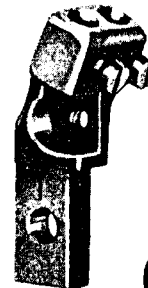
128518



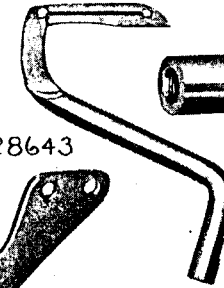
128531



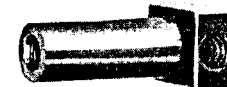
128640



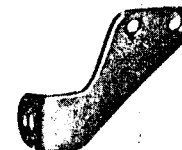
128717



128530



128643



128532



PLATE 9456—FULL SIZE

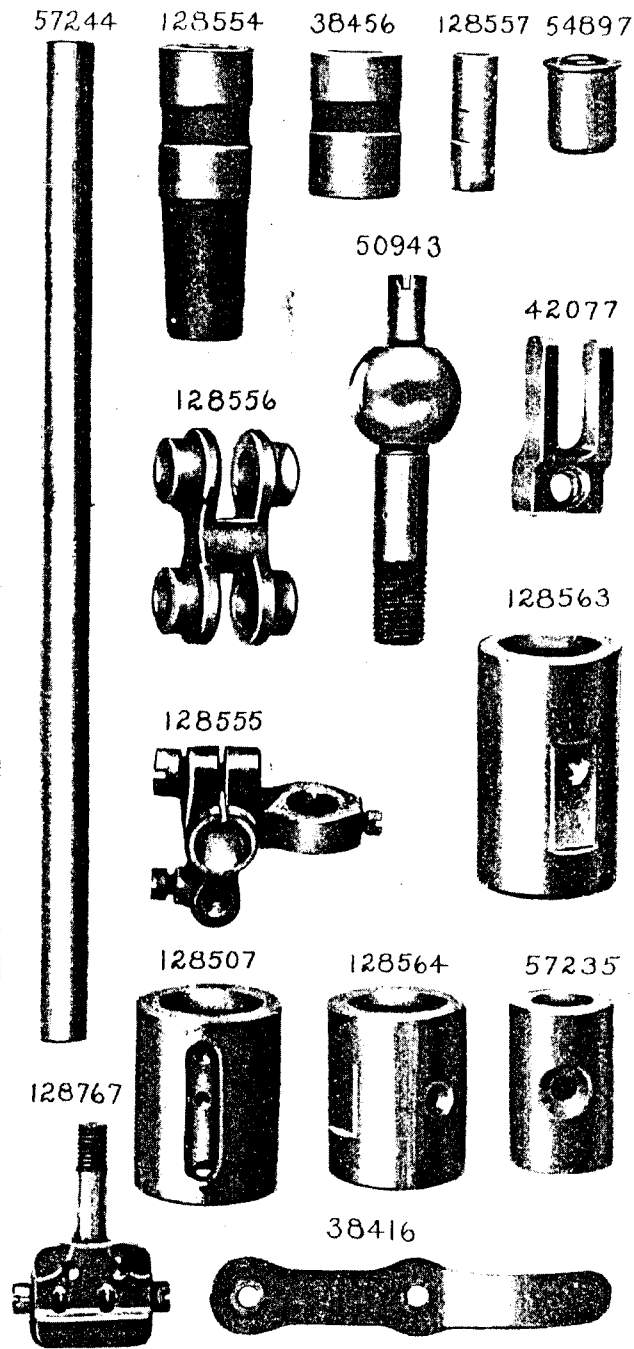


PLATE 9457—FULL SIZE

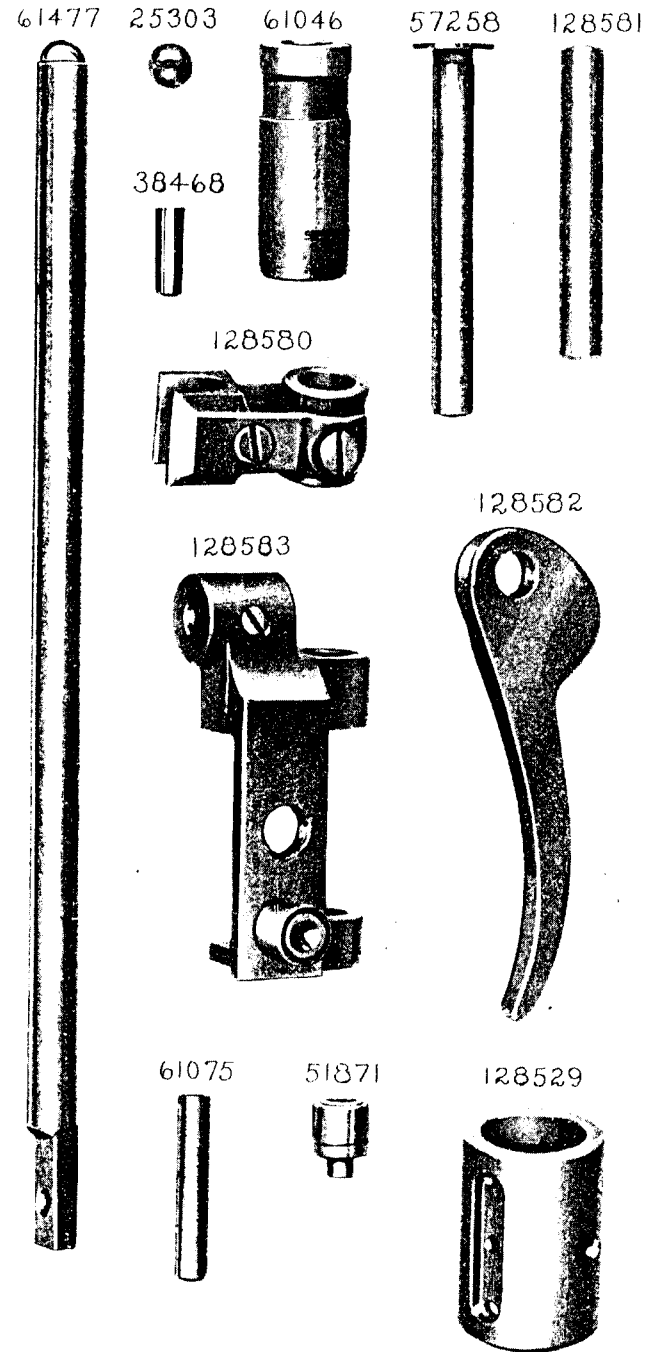


PLATE 9458—FULL SIZE

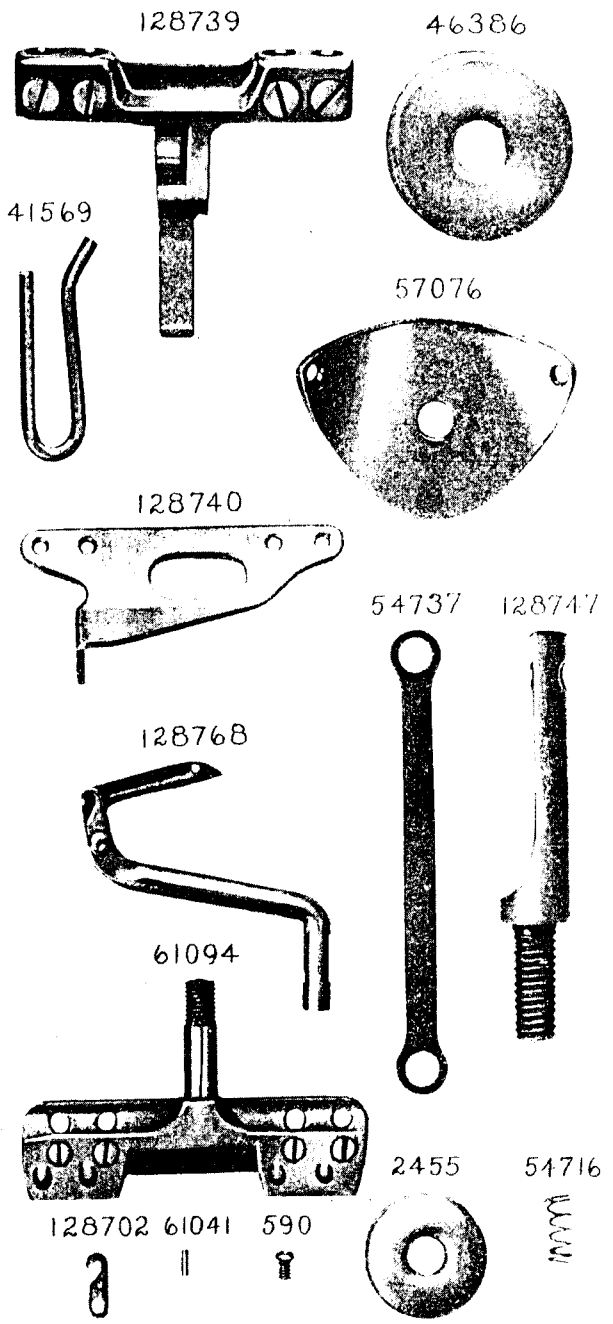


PLATE 9459—FULL SIZE

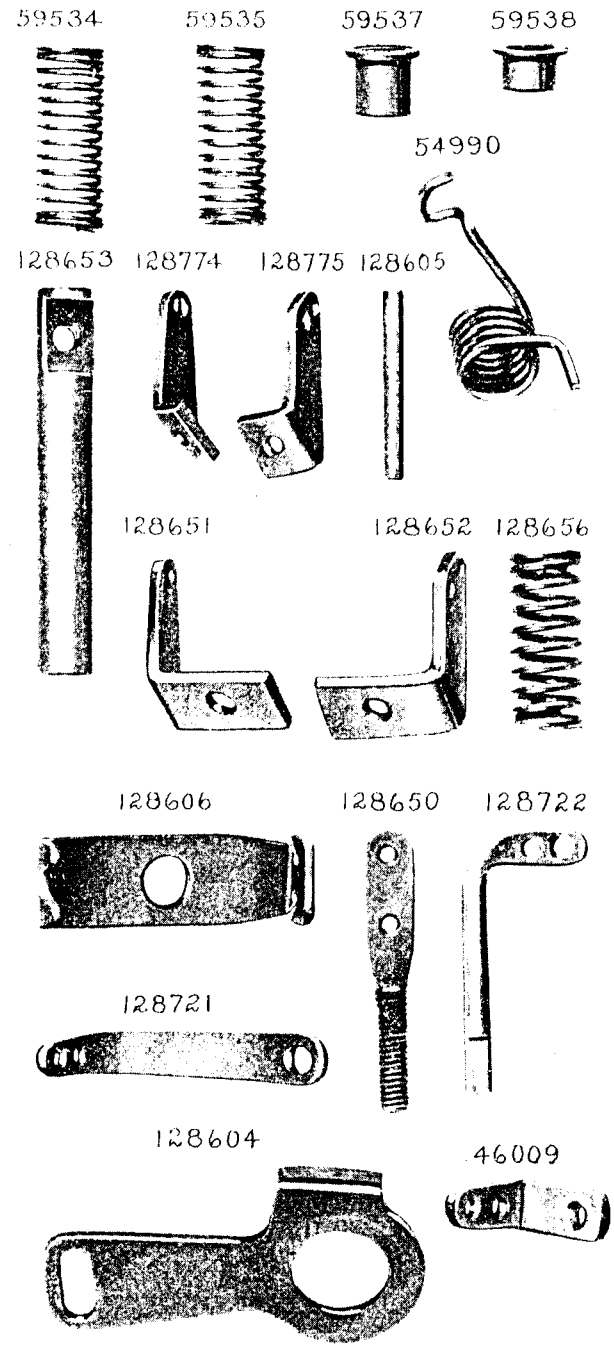


PLATE 9460—FULL SIZE

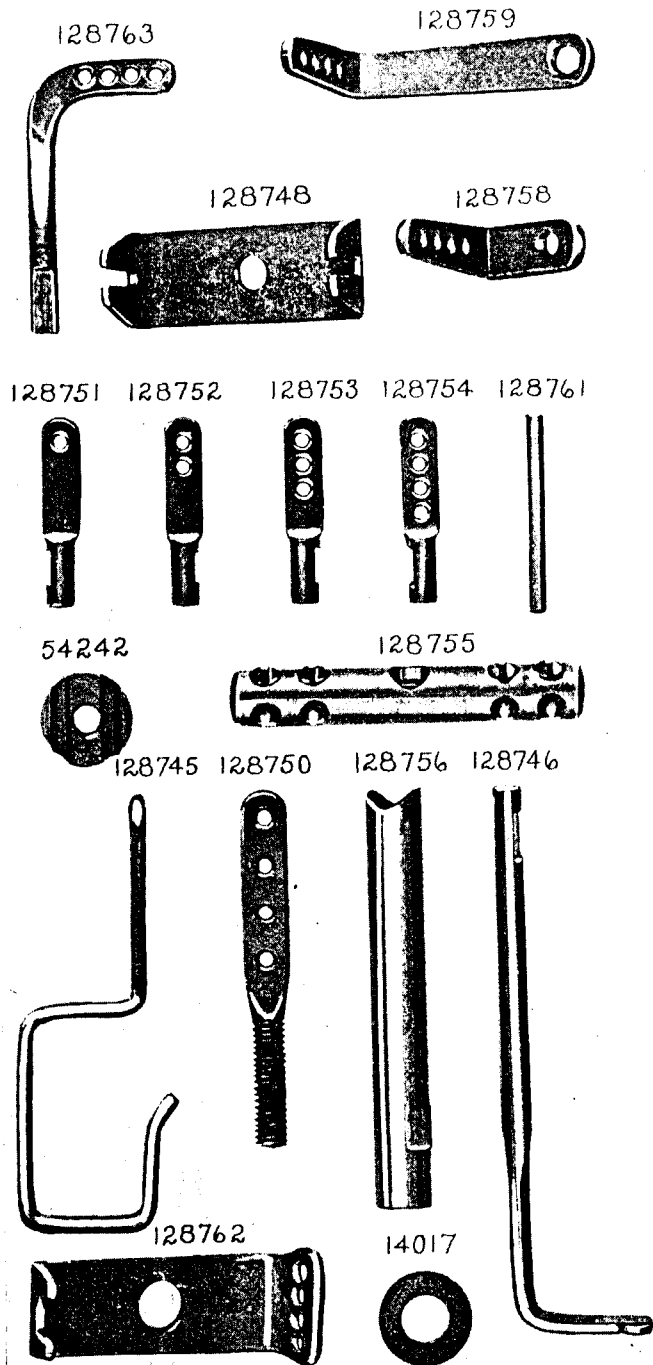


PLATE 9461—FULL SIZE

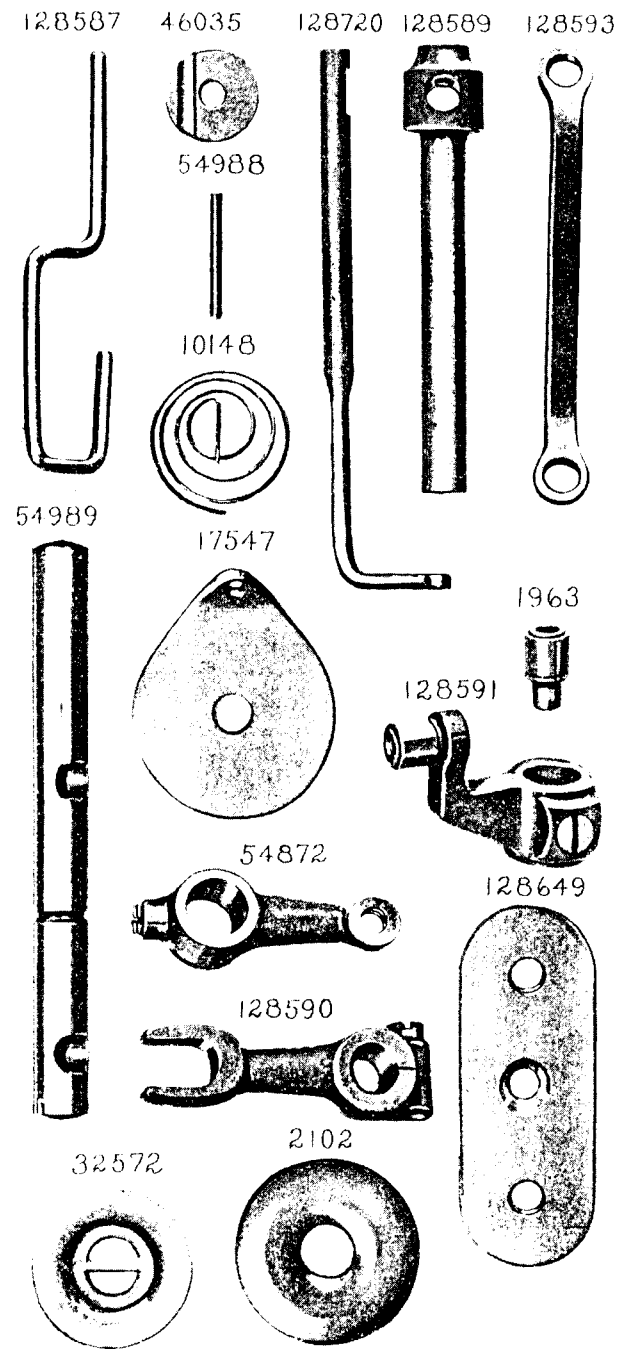


PLATE 9462—FULL SIZE

64508



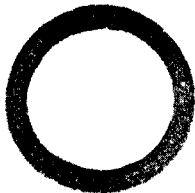
128628



55515



128619



128513



49013



54648



49092



19079



64805



42366



41036



128571

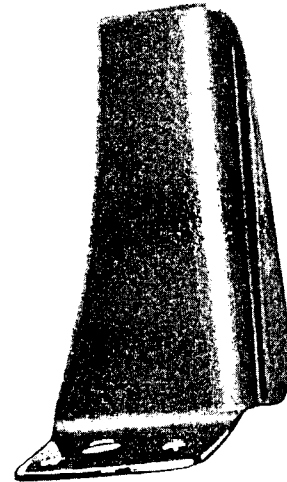


56865



PLATE 9463—ONE-HALF SIZE

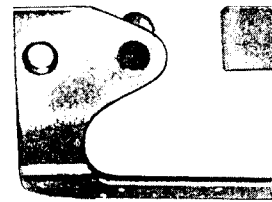
128654



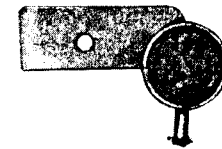
128569 44006 128559



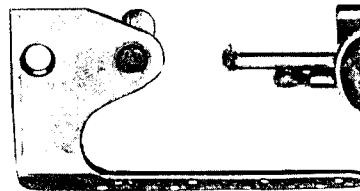
128725



128568



128741



128573



120677



128612

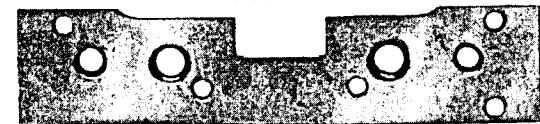
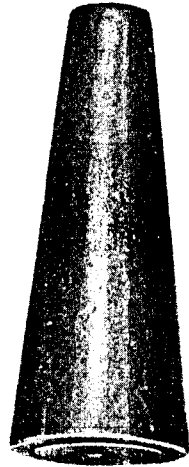
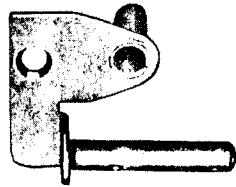


PLATE 9464—ONE-HALF SIZE

27739 54246 128771 54040



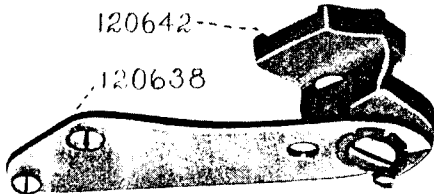
128645



120639

120642

120638



128742



128749

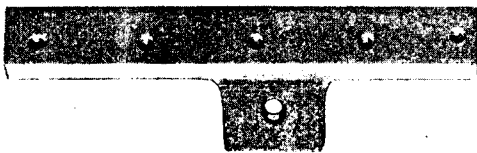


PLATE 9465—FULL SIZE

769 157 896 50152 898 50473



665

725

228

50379

50370



138

50154

1149

155

50282

1057



110

205

724

792

208

175



142

683

171

176

185

190



1443

1198

1239

1423

1095

50999



1235

399

391

1011

997

376



PLATE 9466—FULL SIZE

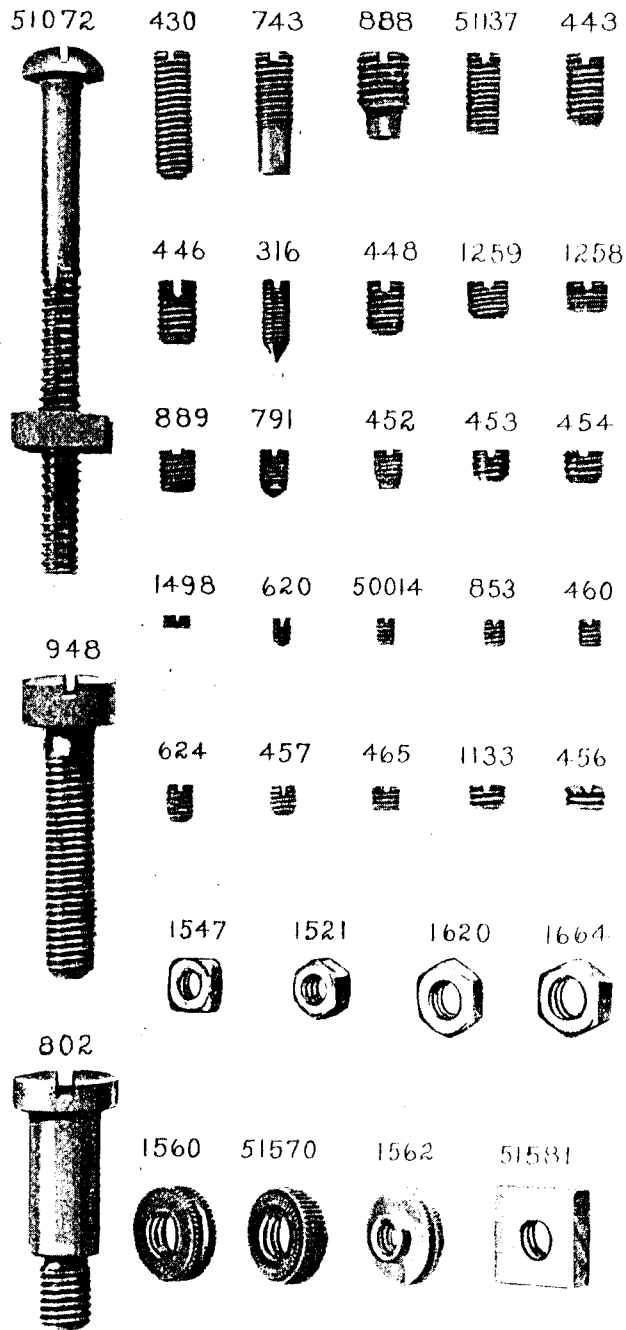


PLATE 9467—FULL SIZE

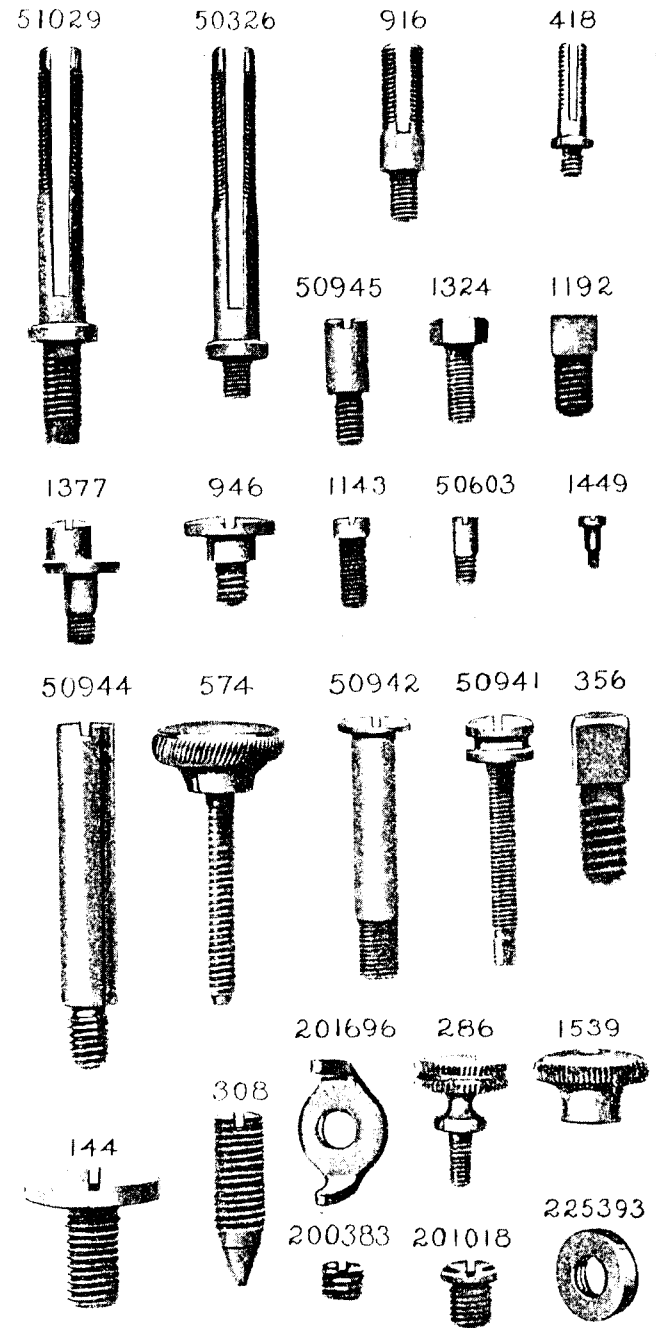
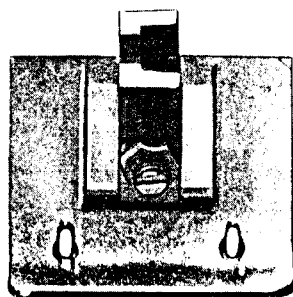
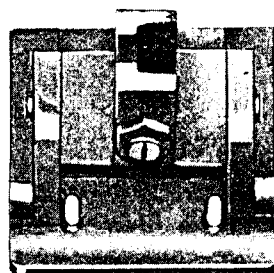


PLATE 9468—FULL SIZE

128719



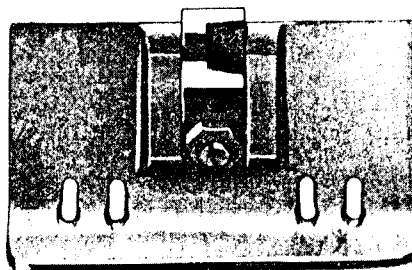
128736



128734

128733

128744



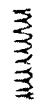
18055



1145



2656



62527



563



1700



PLATE 9469—FULL SIZE

128772



128773

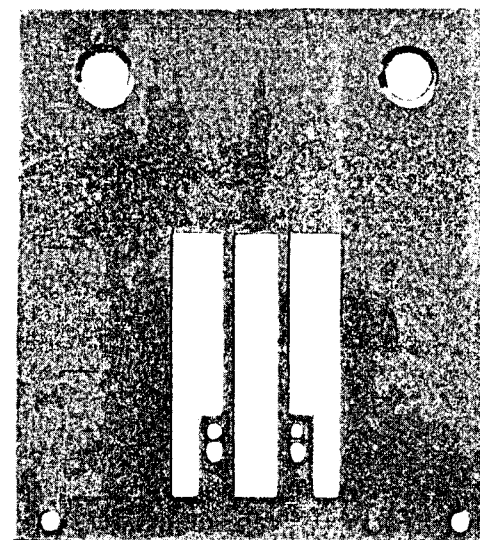


PLATE 9470—FULL SIZE

128729

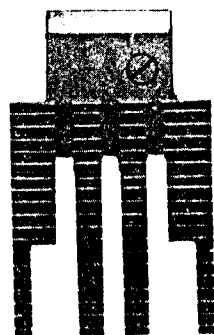
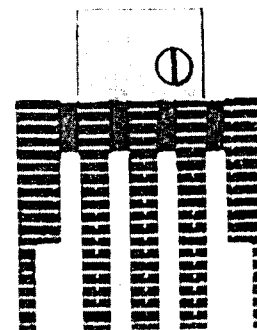
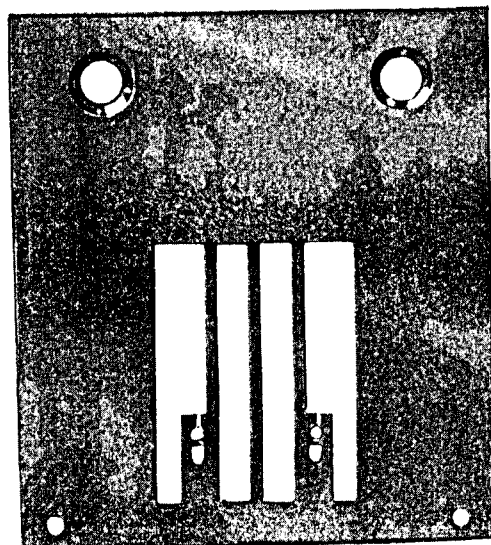


PLATE 9471—FULL SIZE

128716



128730



128723

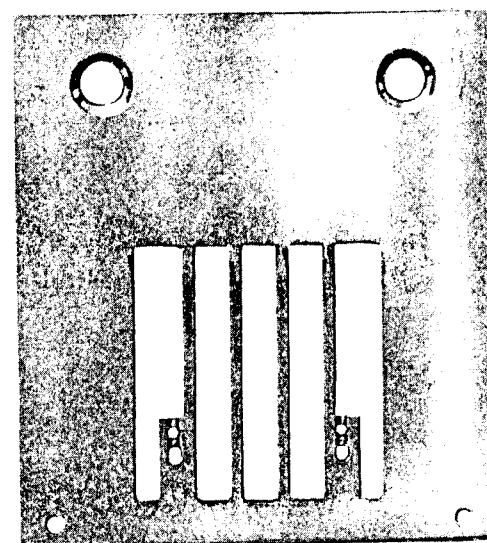
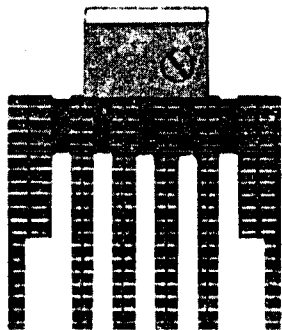
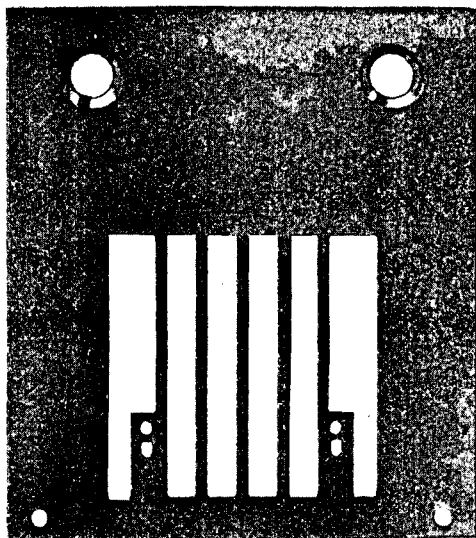


PLATE 9472—FULL SIZE

128726



128727

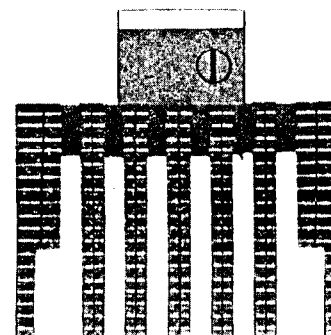


128724



PLATE 9473—FULL SIZE

128731



128732

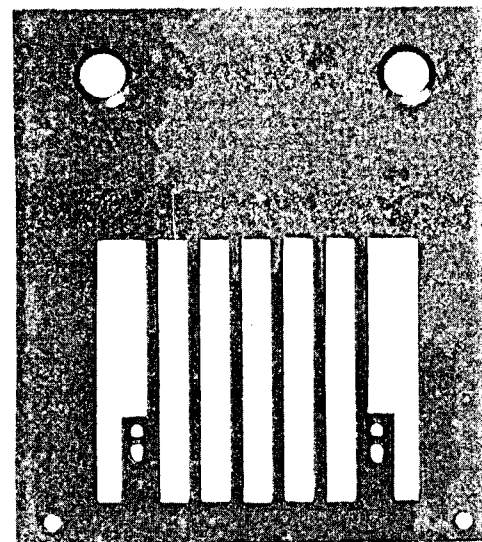
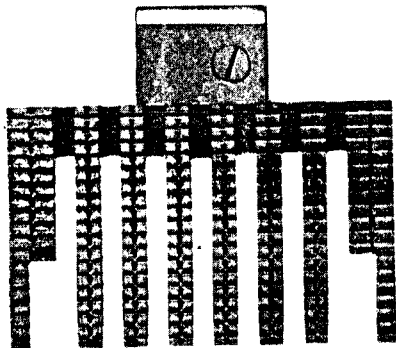


PLATE 9474—FULL SIZE

128821



128822

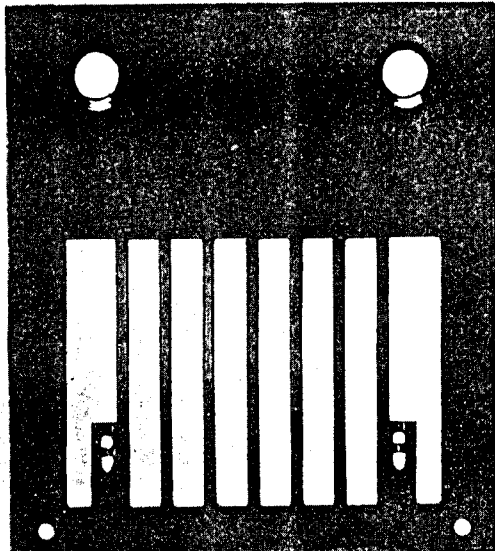
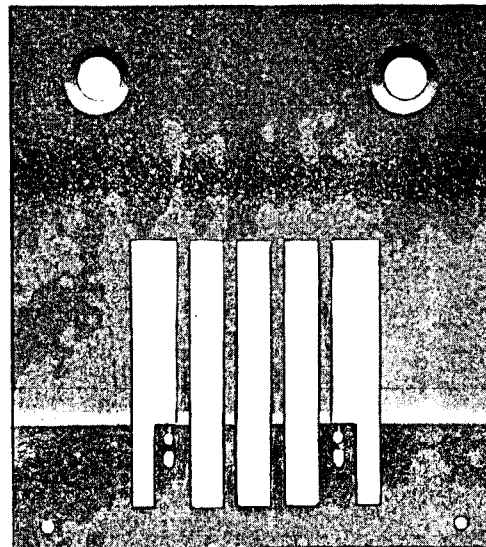


PLATE 9475—FULL SIZE

128737



128770

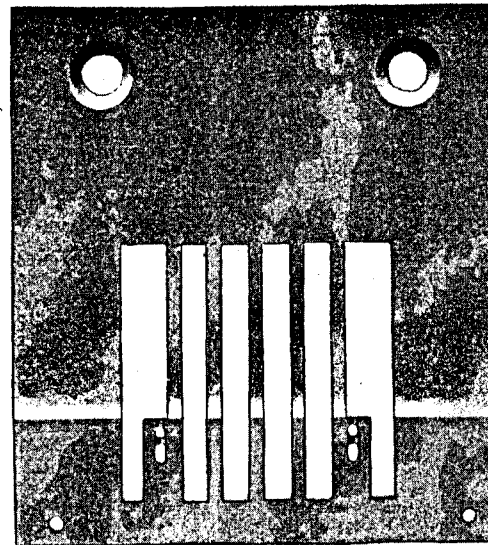
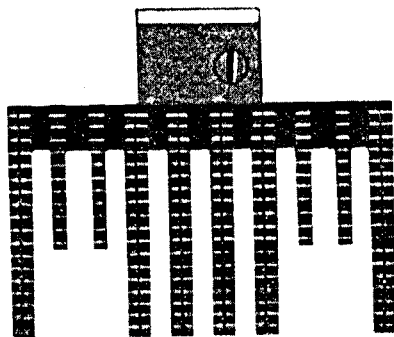
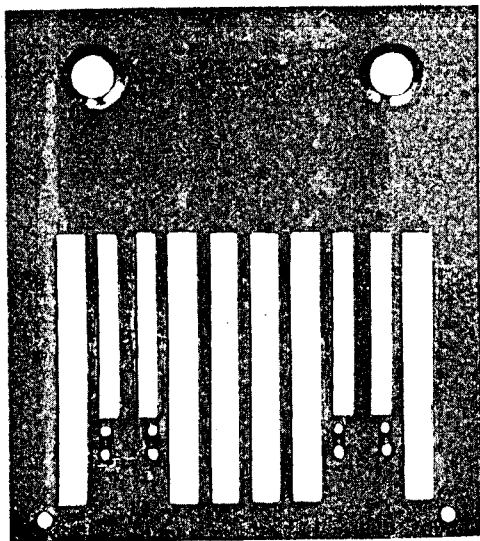


PLATE 9476—FULL SIZE

128738



128764

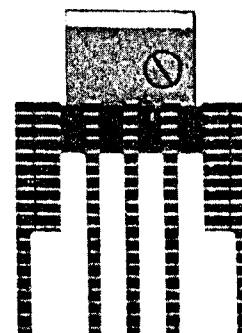


128765



PLATE 9477—FULL SIZE

128637



128658

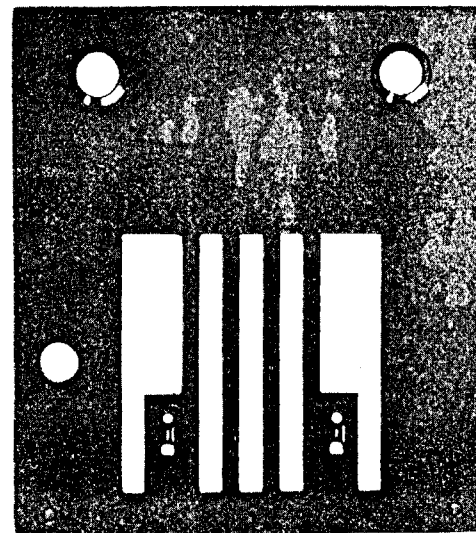
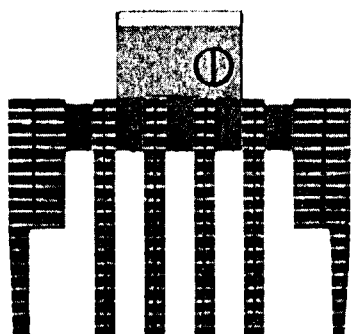


PLATE 9478—FULL SIZE

128661



128662

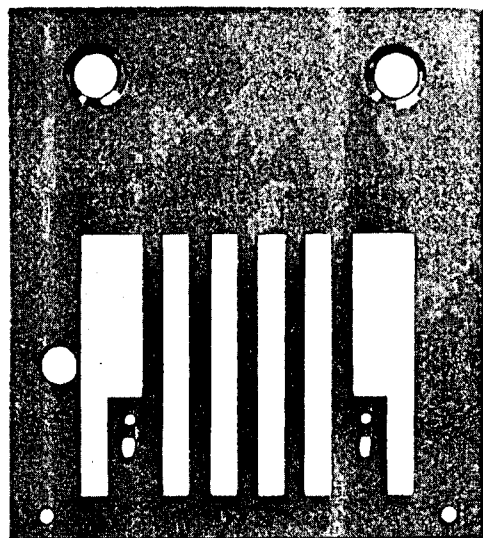
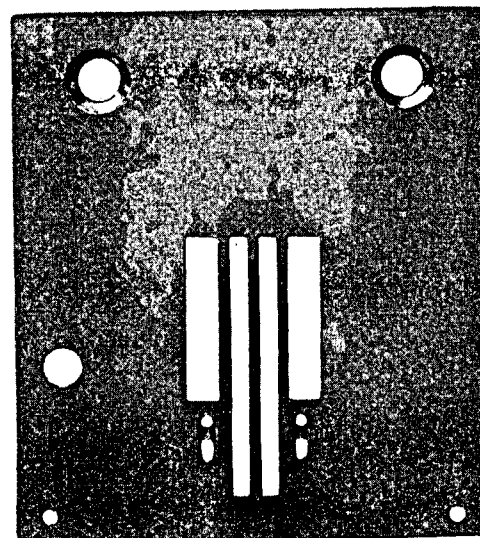


PLATE 9479—FULL SIZE

128700



128701

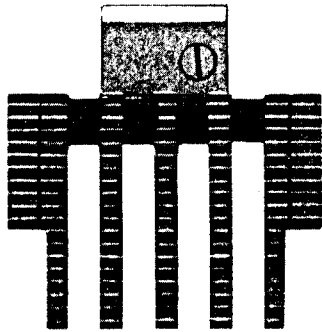


128659



PLATE 9480—FULL SIZE

128705



128706

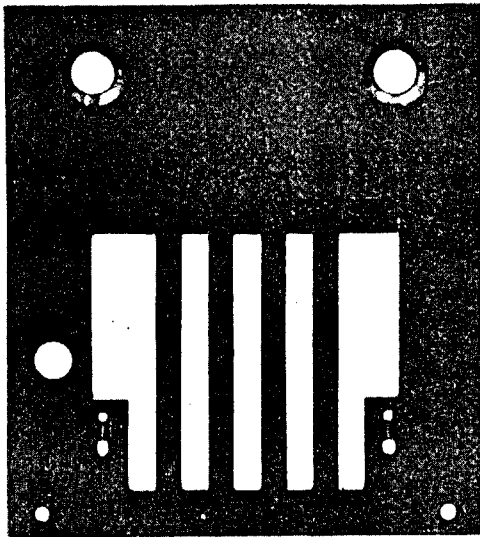


PLATE 9481—FULL SIZE

120660



120658



120661

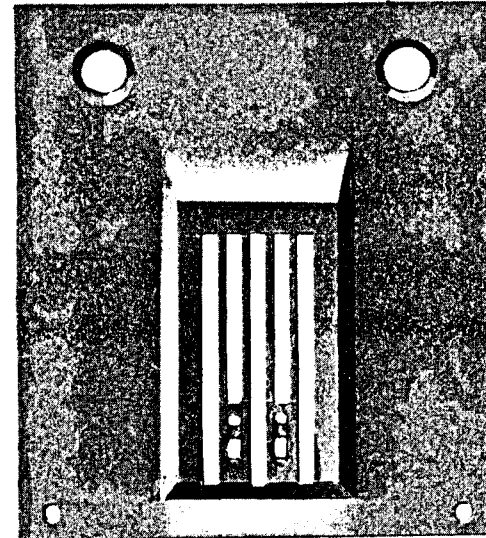
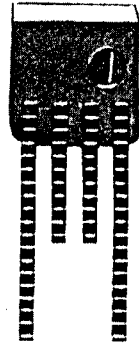


PLATE 9482—FULL SIZE

120705



120706

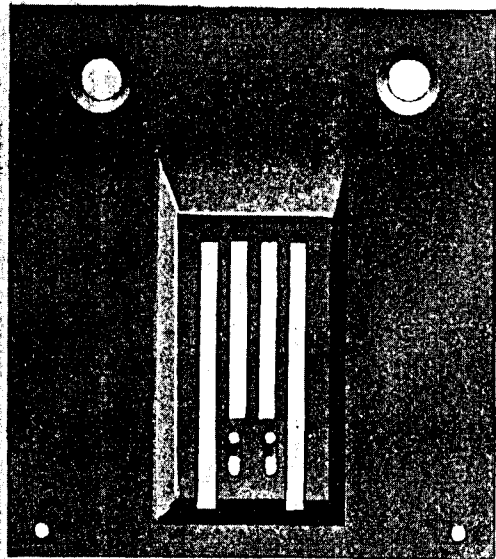
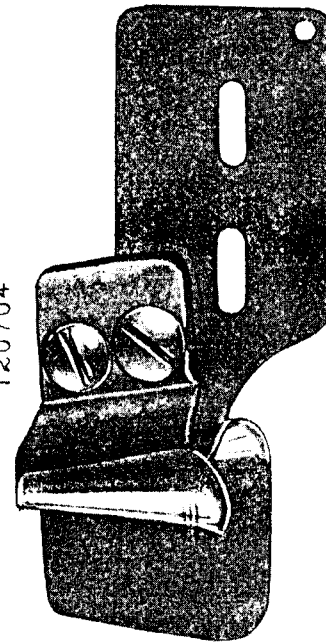


PLATE 9483—FULL SIZE

120704



120657

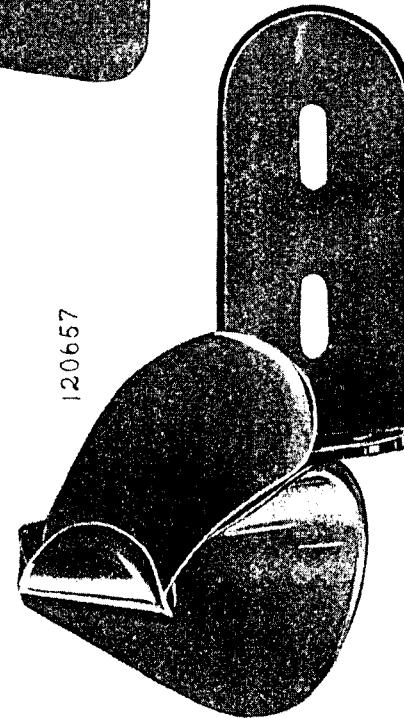
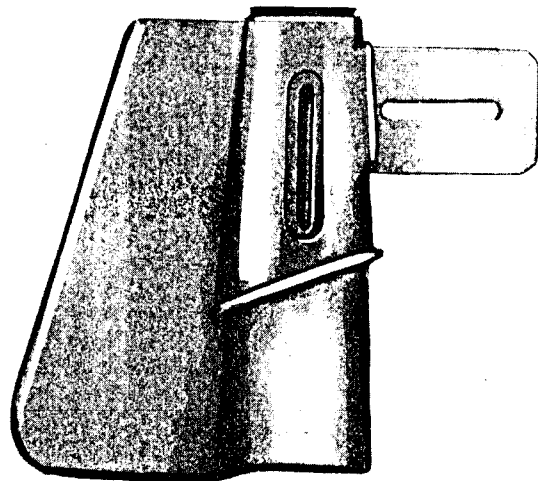


PLATE 9484—ONE-HALF SIZE

120593



120635

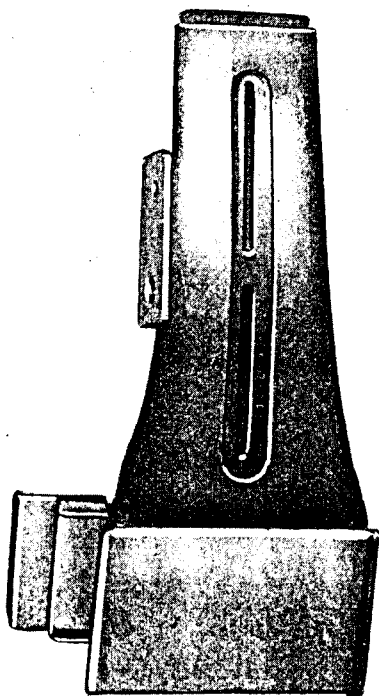
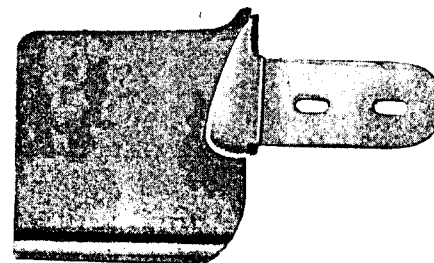
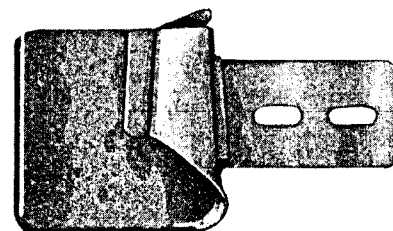


PLATE 9485—ONE-HALF SIZE

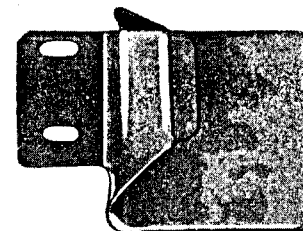
120549



120640



120641



120550

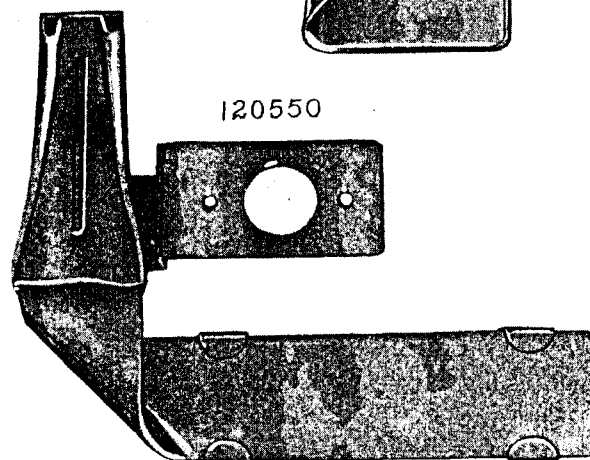
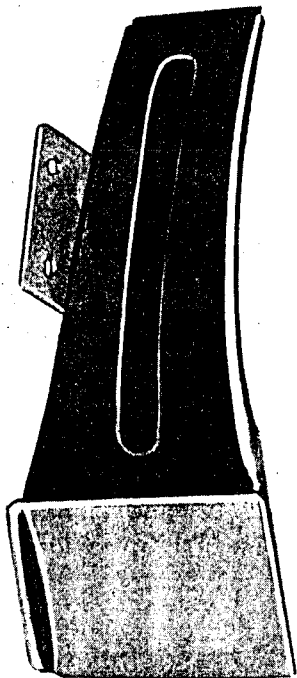
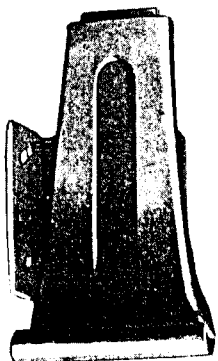


PLATE 9486—ONE-HALF SIZE

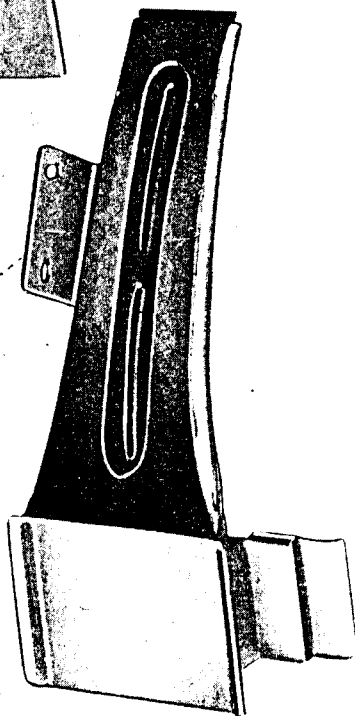
120637



120703



120698

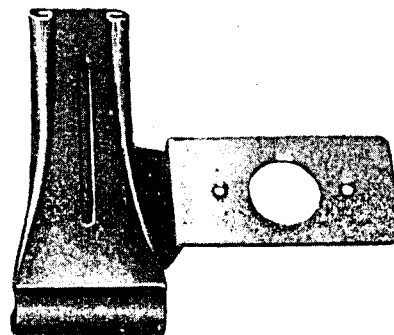


120634

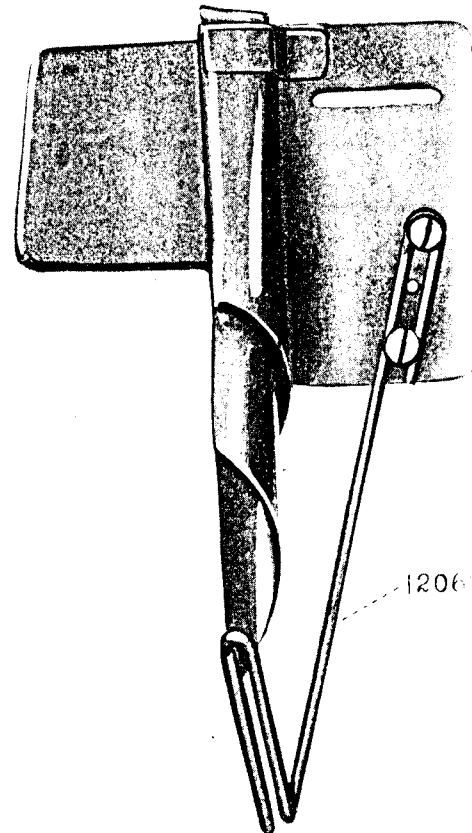


PLATE 9487—ONE-HALF SIZE

120701



120700



120639

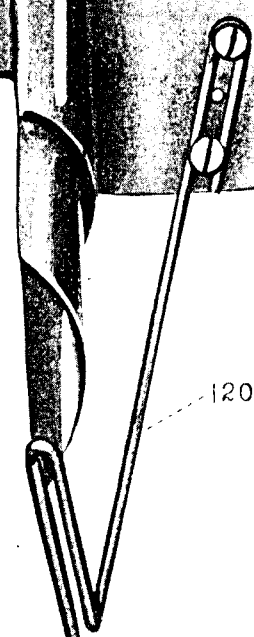


PLATE 9488—ONE-HALF SIZE

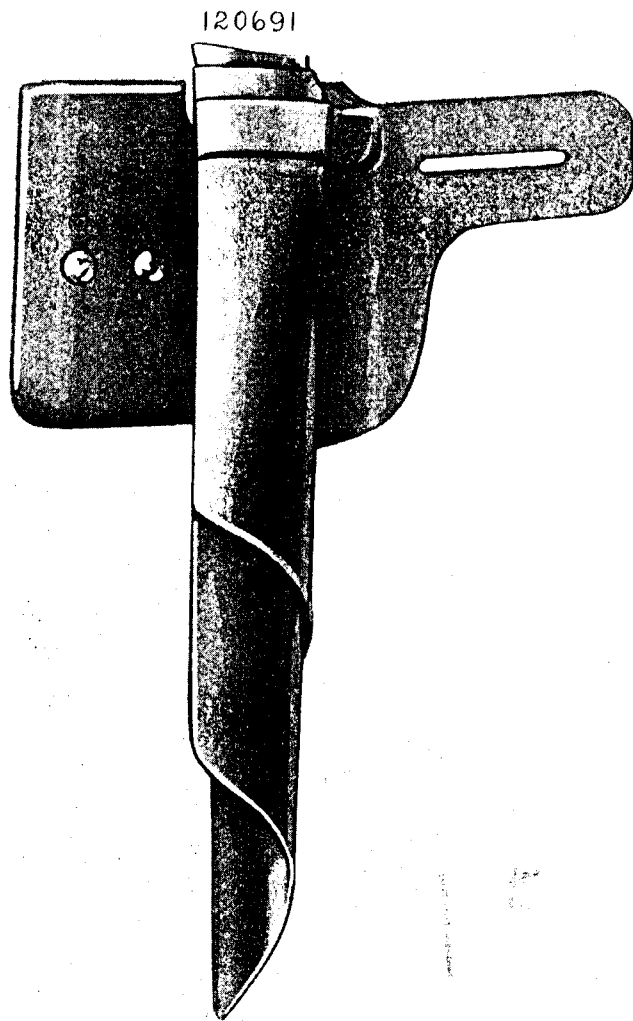


PLATE 9489—ONE-SIXTH SIZE

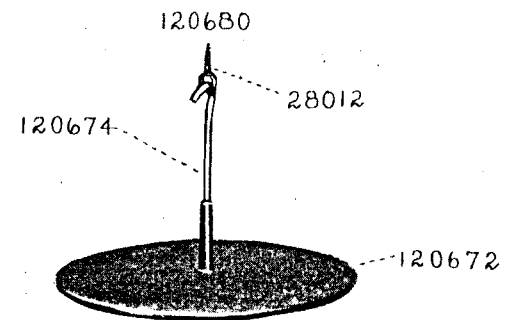
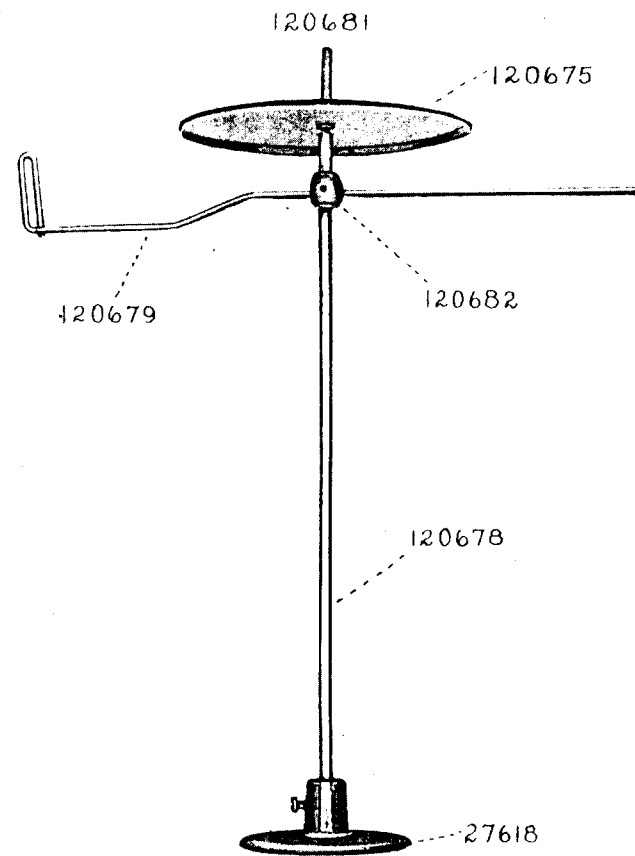


PLATE 9490—FULL SIZE

128588 27347



128610 54-095 43808



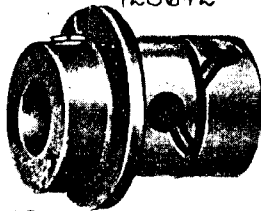
36006



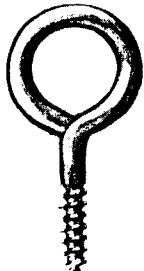
128655



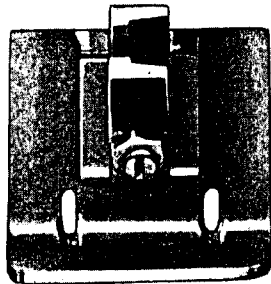
128642



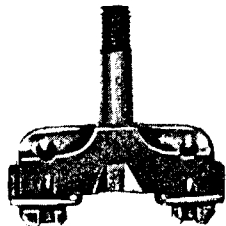
28012



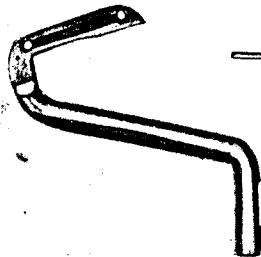
128648



128565



128639



128566



128620



41635

