

# **SINGER**

**152-11**

FORM 19189  
(Rev. 859)  
PRINTED IN U. S. A.

# LIST OF PARTS



# SINGER<sup>\*\*</sup>

MACHINE No. 152-II

THE SINGER MANUFACTURING COMPANY

<sup>\*\*</sup>A Trade Mark of THE SINGER MANUFACTURING COMPANY

## INSTRUCTIONS FOR OILING

To ensure easy running and prevent unnecessary wear of the parts which are in movable contact, the machine requires oiling and when in continuous use, "TYPE D" OIL, sold by Singer Sewing Machine Company should be applied at least twice each day to all oil holes marked "OIL", as instructed in Form 19117.

"TYPE D" OIL is stainless.

## INDEX

	Page
Accessories .....	18
Belt Guards .....	18
Bench Stands .....	19
Edge Folder on Shank .....	25
Fittings .....	20
Foot Lifter Parts .....	21
Knee Lifter Parts .....	21
Machine Bases .....	22
Machine No. 152-11 .....	7
Machine Base Oil Drain Jar .....	24
Numerical list of Parts .....	27
Strip Folders .....	24
Strip Folder on Shank .....	24
Thread Unwinder .....	26

## INSTRUCTIONS FOR ORDERING

In ordering from this list, use ONLY the part NUMBER in the FIRST column.

The number stamped on a Sewing Machine Part is in every case the number of the single part only.

Every combination of parts sent out as such has its specific number, which, although not stamped on the parts, must be used when ordering the combination.

Each number always indicates the SAME PART in whatever list it appears, or for whatever machine.

The letters after some of the numbers indicate the style of finish only, as follows:

- A—Hardened, Polished, Nickel Plated and Buffed
- B—Polished, Nickel Plated and Buffed
- C—Hardened Only
- D—Polished Only
- E—Soft, Not Polished
- F—Hardened and Polished
- G—Bright Rumbled and Nickel Plated
- H—Blued
- J—Nickel Plated Only
- K—Hardened and Nickel Plated
- L—Brass Plated
- M—Oxidized
- R—Phosphate Coating Formed on Surface of Iron or Steel
- S—Cadmium Plated
- T—Copper Plated
- U—Zinc Plated
- V—Silver Plated
- W—Polished and Nickel Plated
- X—Black Oxide for Iron and Steel
- Y—Black Nickel Plated Only
- Z—Chromium Plated
- A.A—Buffed and Chromium Plated
- A.B—Hardened, Polished, Buffed and Chromium Plated
- A.E—Hardened, Bright Rumbled and Nickel Plated
- A.F—Hardened, Bright Rumbled, Nickel Plated, Bright Rumbled and Chromium Plated
- A.G—Alumilite (Plain)
- A.H—Alumilite (Dyed) Color Must be Stated
- A.J—Polished, Nickel Plated and Chromium Plated
- A.K—Hardened, Polished, Nickel Plated and Chromium Plated
- A.L—Heat Treated for Toughness
- A.L.D—Heat Treated for Toughness and Polished
- A.L.X—Heat Treated for Toughness and Black Oxide

## INSTRUCTIONS FOR ORDERING

- A.S—Black Moulded Phenolic
- A.T—Beige Moulded Phenolic
- A.U—Brown Moulded Phenolic
- A.W—Hardened then Flame Coated with Tungsten Carbide
- B.A—Chrome Nickel Satin Finish
- B.B—Hardened and Chrome Nickel, Satin Finished
- C.R—Hardened and Phosphate Coating Formed on Surface of Steel
- F.J—Hardened, Polished and Nickel Plated
- T.A—Hardened, Polished, Copper and Nickel Plated and Buffed
- T.B—Copper and Nickel Plated and Polished
- T.J—Copper and Nickel Plated Only
- T.K—Hardened, Copper and Nickel Plated
- T.L—Copper and Brass Plated
- T.M—Copper Plated and Oxidized
- X.C—Hardened and Black Oxide for Iron and Steel
- Z.A—Hardened, Polished Nickel Plated, Buffed and Chromium Plated
- Z.B—Polished, Nickel Plated, Buffed and Chromium Plated
- Z.C—Hardened and Chromium Plated
- Z.D—Polished and Chromium Plated
- Z.G—Bright Rumbled, Nickel Plated, Bright Rumbled and Chromium Plated
- Z.J—Nickel and Chromium Plated
- Z.T—Copper and Chromium Plated

These letters MUST BE USED when they appear in the list; and AFTER the number as in the list.

In this series:

1 to 1500, 50001 to 51500 and 140001 to 142,000 are screw numbers  
1501 to 1800 and 51500 to 51800 are nut numbers  
1801 to 2000 and 51801 to 52000 are roller numbers  
2001 to 50000 and 52001 to 140000 and 142001 to 190000 are Sewing Machine Parts, 190001 and upward are numbers of Electrical Parts.

The figures in the second column refer only to the plates, illustrating the parts, and are NOT TO BE USED in ordering.

Parts marked with an asterisk (\*) are furnished only when repairs are made at the factory.

When ordering parts which differ as to gauge (the distance between seams), the gauge as well as the number must be given on the order.

LIST OF PARTS COMPLETE  
FOR

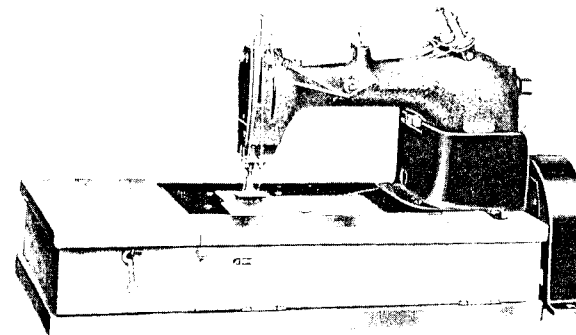

MACHINE No. 152-II

For Stitching Facings and Button Stays on Men's Shirts and Work of Similar Nature on Light and Medium Weight Materials. Two needles, two loopers. Gauges 9/16 to 1 1/2 inches. Ball bearing. Length of Stitch 10 to 25 to the inch.

No.	Plate	Name
*134356	----	Arm, upper and lower (solid) with 51422J, 68483 and four 131022.....
68428	21065	Arm Bottom Cover .....
68429	21065	Arm Bottom Cover Gasket (cork) .....
1057AL	21065	Arm Bottom Cover Screw (4) .....
50608R	21065	Arm Hole Plug Screw, for access to Crank Connecting Rod (upper bearing) .....
139017	21065	Arm Hole Plug Screw Washer .....
68350	21068	Arm Oil Cup, for oiling Arm Rock Shaft Front Bearing .....
131864	21068	Arm Oil Cup .....
131865	21068	Arm Oil Cup Oil Gauge.....
131866	21068	Arm Oil Cup, with Oil Gauge complete, for filling oil reservoir, Nos. 131864 and 131865 .....
131319	21068	Arm Oil Cup Oil Pad (braided cotton) for 68350 .....
131293	21062	Arm Rock Shaft .....
131474	----	Arm Rock Shaft 131293 with 1235F, 127838 and 131475.....
1309C	21062	Arm Rock Shaft Adjusting Screw .....

No.	Plate	Name
131056	21062	Arm Rock Shaft Adjusting Screw Washer....
68433	21062	Arm Rock Shaft Bushing (back).....
68435	21062	Arm Rock Shaft Bushing (back) Cap.....
131095	21062	Arm Rock Shaft Bushing (back) Cap Washer (fiber).....
446AL	21062	Arm Rock Shaft Bushing (back) Set Screw....
68436	21062	Arm Rock Shaft Bushing (intermediate).....
423AL	21062	Arm Rock Shaft Bushing (intermediate) Set Screw.....
131343	21063	Arm Rock Shaft Crank, back (ball bearing, solid) with two 51407AL.....
51407AL	21063	Arm Rock Shaft Crank (back) Set Screw....
*131475	-----	Arm Rock Shaft Crank (front) with 853AL...
127838	21062	Arm Rock Shaft Crank (front) Pin.....
131456	21062	Arm Rock Shaft Flanged Bushing (front)....
453AL	21062	Arm Rock Shaft Flanged Bushing (front) Set Screw.....
42365	21062	Arm Rock Shaft Oil Pad for oiling Back Bearing.....
54969	21062	Arm Rock Shaft Oil Pad for oiling Inter- mediate Bearing.....
1235F	21062	Arm Rock Shaft Oil Plug Screw.....
*131476	21063	Arm Rotary Shaft.....
134357	-----	Arm Rotary Shaft 131476 with 640E, 131502, 131929 and 134312.....
131366	21063	Arm Rotary Shaft Ball Bearing (back) (2)...
131478	21063	Arm Rotary Shaft Ball Bearing (back) Case.
131479	-----	Arm Rotary Shaft Ball Bearing (back) Case 131478 with 131369 and three 205C.....
131526	-----	Arm Rotary Shaft Ball Bearing (back) Case with Ball Bearings complete, Nos. 131479, 131480 and two 131366.....
131369	21063	Arm Rotary Shaft Ball Bearing (back) Case Cap.....
205C	21063	Arm Rotary Shaft Ball Bearing (back) Case Cap Screw (3).....
131370	21063	Arm Rotary Shaft Ball Bearing (back) Case Position Stud (3).....
429C	21063	Arm Rotary Shaft Ball Bearing (back) Case Set Screw (3).....
131480	21063	Arm Rotary Shaft Ball Bearing (back) Spacing Collar.....
131366	21063	Arm Rotary Shaft Ball Bearing (intermediate).....
131481	21063	Arm Rotary Shaft Ball Bearing (intermediate) Case.....
1304C	21063	Arm Rotary Shaft Ball Bearing (intermediate) Case Set Screw.....
131482	21063	Arm Rotary Shaft Ball Bearing (intermediate) Collar with two 457AL....
457AL	21063	Arm Rotary Shaft Ball Bearing (intermediate) Collar Set Screw (2).....
131457	21063	Arm Rotary Shaft Bushing (front).....

No.	Plate	Name
761E	21063	Arm Rotary Shaft Bushing (front) Set Screw
42367	21068	Arm Rotary Shaft Front Bearing Oil Pad, lower (braided cotton).....
54218	21068	Arm Rotary Shaft Front Bearing Oil Pad, upper (braided cotton).....
144D	21063	Arm Rotary Shaft Screw.....
131276	21065	Arm Side Cover (oil vent).....
131909	21065	Arm Side Cover Cap.....
131910	21065	Arm Side Cover Cap Spring.....
131280	21065	Arm Side Cover Cap Position Pin.....
1289X	21065	Arm Side Cover Cap Thumb Screw.....
131911	-----	Arm Side Cover (oil vent) complete, Nos. 1289X, 131276, 131280, 131909 and 131910.....
68448	21065	Arm Side Cover Gasket (cork).....
1057AL	21065	Arm Side Cover Screw (4).....
134358	21064	Cloth Plate with two 1198C.....
134329	21064	Cloth Plate Slide.....
134330	21064	Cloth Plate Slide Spring (back).....
134305	21064	Cloth Plate Slide Spring (side) (2).....
665J	21064	Cloth Plate Slide Spring Screw (6).....
134331	21064	Cloth Plate Slide complete, Nos. 134329, 134330, two 134305 and six 665J.....
134359	21064	Cloth Plate complete, Nos. 134331 and 134358.....
1011F	21064	Cloth Plate Screw (left) (3).....
50396F	21064	Cloth Plate Screw (right).....
134254	21064	Cloth Plate Supporting Post.....
1620R	21064	Cloth Plate Supporting Post Lock Nut.....
134255	21064	Cloth Plate Supporting Post Spacing Collar.
131610	21064	Cloth Plate Thread Guard.....
389F	21064	Cloth Plate Thread Guard Screw (lower)...
50473F	21064	Cloth Plate Thread Guard Screw (upper)...
131926	21063	Crank Connecting Rod with two each 1057AL, 51715AL, 131927 and 131928.....
NOTE: When No. 131926 is required for repairs, Connecting Rod and Arm Rock Shaft Crank (back) fitted together, will be furnished, in order to obtain correct Needle Bar Stroke.		
131929	-----	Crank Connecting Rod 131926 with 131343..
51715AL	21063	Crank Connecting Rod Cap (lower) Nut.....
131927	21063	Crank Connecting Rod Cap (lower) Nut Stud.
131928	-----	Crank Connecting Rod Cap (lower) Nut Stud Nut Lock Washer.....
1057AL	21063	Crank Connecting Rod Cap (upper) Screw (2)
134256	21065	Face Plate (lower half).....
134257	21065	Face Plate (lower Half) Gasket (cork)....
330D	21065	Face Plate (lower Half) Screw (2).....
131395	21065	Face Plate (upper half).....
29234	21065	Face Plate (upper half) Position Plate....
1053E	21065	Face Plate (upper half) Position Plate Screw
51224W	21065	Face Plate (upper half) Thumb Screw.....
134389	21066	Feed Bar.....

No.	Plate	Name
134390	-----	Feed Bar complete, Nos. 50429AL, 54648, 68467, 134315, 134389, two each 207E and 211E.....
134315	21066	Feed Bar Guide.....
211E	21066	Feed Bar Guide Screw (2).....
131197	21066	Feed Bar Hinge Pin (eccentric).....
59343	21066	Feed Bar Hinge Pin Collar with 735AL.....
735AL	21066	Feed Bar Hinge Pin Collar Set Screw.....
54648	21066	Feed Bar Oil Pad.....
134316	21066	Feed Bar Position Plate.....
181E	21066	Feed Bar Position Plate Screw.....
131943	21066	Feed Bar Slide Block.....
131944	21066	Feed Bar Slide Block 131943 with 68495 and 134260.....
68495	21066	Feed Bar Slide Block Oil Pad (wick).....
134260	21066	Feed Bar Slide Block Oil Pad Retainer.....
68467	21066	Feed Bar Wearing Plate.....
207E	21066	Feed Bar Wearing Plate Screw (2).....
131500	21063	Feed Connecting Rod with 1057AL, 68497, 134260 and two 896AL.....
131502	-----	Feed Connecting Rod 131500 with 54025.....
896AL	21063	Feed Connecting Rod Cap Screw (2).....
1057AL	21063	Feed Connecting Rod Clamping Screw.....
68497	21063	Feed Connecting Rod Oil Pad (wick).....
134260	21063	Feed Connecting Rod Oil Pad Retainer.....
134333	21033	Feed Dog, 21 teeth (16 teeth to the inch) for 11/16 and 3/4 in. gauges, for 134343, for shirt centering on broadcloth and similar materials.
134334	21033	Feed Dog, 21 teeth (16 teeth to the inch) for 7/8 in. and 1 in. gauges, for 134344, for shirt centering on broadcloth and similar materials.
		NOTE: Feed Dog No. 134333 or 134334 is regularly furnished with this machine unless otherwise stated on order.
157J	21033	Feed Dog Screw.....
50429AL	21066	Feed Dog Stop Screw.....
51061AL	21063	Feed Eccentric Body Set Screw (2).....
7071	21063	Feed Eccentric Clamping Washer (2).....
217J	21063	Feed Eccentric Clamping Washer Screw (2).....
138306	-----	Feed Eccentric Lubricating Pad (wood).....
54025	21063	Feed Eccentric (adjustable) complete, Nos. 1103C, 138306 and two each 217J, 7071 and 51061C.....
1103C	21063	Feed Regualting Screw.....
131240	21066	Feed Rocking Frame with two 453AL.....
134391	-----	Feed Rocking Frame 131240 with 59343, 131197 and 134390.....
57234	21066	Feed Rocking Frame Hinge Pin.....
57235	21066	Feed Rocking Frame Hinge Pin Bushing (2).....
453AL	21066	Feed Rocking Frame Hinge Pin Bushing Set Screw (2).....

No.	Plate	Name
453AL	21066	Feed Rocking Frame Hinge Pin Set Screw (2).....
134347	21035	Looper (left) for 9/16 in. gauge.....
134346	21035	Looper (right) for 9/16 in. gauge.....
134349	21035	Looper (left) for 5/8 in. gauge.....
134348	21035	Looper (right) for 5/8 in. gauge.....
134351	21035	Looper (left) for 11/16 in. gauge.....
134350	21035	Looper (right) for 11/16 in. gauge.....
134360	21033	Looper (left or right) for 3/4 in. to 1 1/2 in. gauges (2).....
175AL	21027	Looper Clamping Screw (2).....
68479	21066	Looper Driver with four 175AL.....
175AL	21066	Looper Driver Cap Screw (4).....
134266	21027	Looper Driver Connection with 134267.....
134392	-----	Looper Driver Connection 134266 with 134272.....
*134267	-----	Looper Driver Connection Oil Plug.....
131957	21066	Looper Driving Shaft and Feed Lifting Eccentric.....
		NOTE: When No. 131957 is required for repairs, the Arm Rotary Shaft must be returned to the factory to be adjusted to the new part.
134312	-----	Looper Driving Shaft and Feed Lifting Eccentric 131957 with 68479.....
68483	-----	Looper Driving Shaft and Feed Lifting Eccentric Bracket with 761E.....
51422J	21066	Looper Driving Shaft and Feed Lifting Eccentric Bracket Screw.....
131959	21066	Looper Driving Shaft and Feed Lifting Eccentric Bushing.....
131028	21066	Looper Driving Shaft and Feed Lifting Eccentric Bushing Oil Screw Plug.....
761E	21066	Looper Driving Shaft and Feed Lifting Eccentric Bushing Position Screw.....
68497	21066	Looper Driving Shaft and Feed Lifting Eccentric Front Bearing Oil Pad (wick).....
640E	21066	Looper Driving Shaft and Feed Lifting Eccentric Screw.....
134268	21027	Looper Holder (left) with 175AL.....
134269	21027	Looper Holder (right) with 175AL.....
134270	21027	Looper Holder Connection for 3/4 in. and 13/16 in. gauges.....
		NOTE: When No. 134270 is required for 9/16 in., 5/8 in. or 11/16 in. gauge, the part will be furnished in 3/4 in. gauge and the desired gauge can be obtained by using the Loopers listed for gauge required.
134271	21027	Looper Holder Connection for 7/8 in. to 1 1/2 in. gauges.....
		NOTE: When ordering No. 134270 or No. 134271, state gauge required.
134272	21027	Looper Holder Connection Hinge Stud with 175AL.....

No.	Plate	Name
1454C	21027	Looper Holder Connection Hinge Stud Cap Screw.....
134310	21027	Looper Holder Connection Hinge Stud Cap Screw Washer.....
175AL	21027	Looper Holder Connection Hinge Stud Clamping Screw.....
50464C	21027	Looper Holder Hinge Screw (2).....
1651E	21027	Looper Holder Hinge Screw Nut (2).....
134273	21027	Looper Throw-out Crank.....
134274	21027	Looper Throw-out Crank Compression Plate
134275	-----	Looper Throw-out Crank Compression Plate 134274 with 26276 and 134276.....
26276	21027	Looper Throw-out Crank Compression Plate Hinge Pin.....
134276	21027	Looper Throw-out Crank Compression Plate Hinge Stud.....
435AL	21027	Looper Throw-out Crank Compression Plate Hinge Stud Set Screw.....
18413	21027	Looper Throw-out Crank Compression Plate Spring (2).....
134277	21027	Looper Throw-out Crank Handle with two 462AL.....
462AL	21027	Looper Throw-out Crank Handle Set Screw (2).....
134278	21027	Looper Throw-out Slide Block.....
		NOTE: When ordering No. 134278, state gauge of Machine for which required.
134307	-----	Looper Throw-out Slide Block 134278 with 134273, 134277, 134279, 134280, 134281, 134282, 134283, two 134284 and four 219J.....
134308	-----	Looper Throw-out Slide Block 134307 with 1454C, 134268, 134269, 134270, 134310, 134392 and two each 1651E and 50464C for 3/4 in. and 13/16 in. gauges.....
		NOTE: When No. 134308 is required for 9/16 in., 5/8 in. or 11/16 in. gauge, the part will be furnished in 3/4 in. gauge and the desired gauge can be obtained by using the Loopers listed for gauge required.
134309	-----	Looper Throw-out Slide Block 134307 with 1454C, 134268, 134269, 134271, 134310, 134392 and two each 1651E and 50464C, for 7/8 in. to 1 1/2 in. gauges.....
		NOTE: When ordering No. 134308 or No. 134309, state gauge required.
134279	21027	Looper Throw-out Slide Block Bracket (left)
1396D	21027	Looper Throw-out Slide Block Bracket (left) Screw.....
134280	21027	Looper Throw-out Slide Block Bracket (right).....
1396D	21027	Looper Throw-out Slide Block Bracket (right) Screw.....

No.	Plate	Name
134281	21027	Looper Throw-out Slide Block Bracket Gib (left).....
219J	21027	Looper Throw-out Slide Block Bracket Gib (left) Screw (2).....
134282	21027	Looper Throw-out Slide Block Bracket Gib (right).....
219J	21027	Looper Throw-out Slide Block Bracket Gib (right) Screw (2).....
134283	21027	Looper Throw-out Slide Block Oil Pad.....
134284	21027	Looper Throw-out Slide Block Oil Pad Retaining Pin.....
131914	21063	Machine Pulley with two 51283AL.....
51283AL	21063	Machine Pulley Set Screw (2).....
131497	21067	Needle Bar (hollow).....
134361	-----	Needle Bar complete, Nos. 131497 and 134286.....
		NOTE: When ordering No. 134361, state gauge required.
131291	21067	Needle Bar Bushing (lower).....
1133AL	21067	Needle Bar Bushing (lower) Set Screw.....
64320	21067	Needle Bar Bushing (upper).....
1133AL	21067	Needle Bar Bushing (upper) Set Screw.....
68488	21067	Needle Bar Connecting Link and Thread (upper) Controller.....
131491	-----	Needle Bar Connecting Link and Thread (upper) Controller 68488 with 68489 and 131492.....
68489	21067	Needle Bar Connecting Link Hinge Stud (hollow).....
1520J	21067	Needle Bar Connecting Link Hinge Stud Nut..
131270	21067	Needle Bar Connecting Link Hinge Stud Oil Pad (wick).....
861C	21067	Needle Bar Connecting Link Hinge Stud Oil Plug Screw.....
853AL	21062	Needle Bar Connecting Link Hinge Stud Set Screw.....
131492	21067	Needle Bar Connecting Stud with 1492E.....
1492E	21067	Needle Bar Connecting Stud Clamping Screw.
134286	21067	Needle Clamp with two 50379F.....
		NOTE: When ordering No. 134286, state gauge required.
134352	21035	Needle Guard for 9/16 in. to 11/16 in. gauges.....
134287	21033	Needle Guard for 3/4 in. to 1 1/16 in. gauges.....
134288	21036	Needle Guard for 1 1/8 in. to 1 1/2 in. gauges.....
		NOTE: When ordering Needle Guards, state gauge required.
134289	21033	Needle Guard Holder.....
176J	21033	Needle Guard Holder Screw.....
217J	21033	Needle Guard Screw.....
50379F	21067	Needle Set Screw (2).....



No.	Plate	Name
68492	21068	Oil Pipe (back of arm) with 68497, for oiling Feed Rocking Frame Hinge Pin Front Bearing.....
68493	21068	Oil Pipe (back of arm) Clamp.....
176E	21068	Oil Pipe (back of arm) Clamp Screw.....
68494	21068	Oil Pipe (back of arm) Connection with 68495 and two 198E, for oiling Feed Rocking Frame Hinge Pin Back Bearing....
198E	21068	Oil Pipe (back of arm) Connection Cap Screw (2).....
68495	21068	Oil Pipe (back of arm) Connection Oil Pad (wick) .....
68496	21068	Oil Pipe (back of arm) Coupling (brass) ....
1733	21068	Oil Pipe (back of arm) Coupling Nut (brass) .....
68497	21068	Oil Pipe (back of arm) Oil Pad (wick) .....
134290	21068	Oil Pipe (front of arm) with 131089, 134294 and two 1733, for oiling Looper Driving Shaft and Feed Lifting Eccentric Front Bearing .....
134291	21068	Oil Pipe (front of arm) with 68497 and 131003, for oiling Feed Bar .....
134292	21068	Oil Pipe (front of arm) with 1733, 68497 and 131003, for oiling Arm Rotary Shaft Front Bearing.....
134362	21068	Oil Pipe (front of arm) with 68497 and 134295, for oiling Feed Connecting Rod...
*134294	-----	Oil Pipe (front of arm) with 68497, for oiling Looper Throw-out Device, for 134290 .....
131003	21068	Oil Pipe (front of arm) Connection with two 198E, for 134291 and 134292 (2).....
134295	21068	Oil Pipe (front of arm) Connection with two 198E for 134362 .....
198E	21068	Oil Pipe (front of arm) Connection Cap Screw (6).....
131004	21068	Oil Pipe (front of arm) Coupling (center) ...
131004	21068	Oil Pipe (front of arm) Coupling (left).....
131087	21068	Oil Pipe (front of arm) Coupling (right) ...
1733	21068	Oil Pipe (front of arm) Coupling Nut (brass) (3) .....
68497	21068	Oil Pipe (front of arm) Oil Pad (wick) for 134291, 134292, 134294 and 134362 (4)...
131089	21068	Oil Pipe (front of arm) Oil Pad (wick) for 134290 .....
134363	-----	Oil Pipe (front of arm) complete, Nos. 134290, 134291, 134292 and 134362.....
131912	21067	Presser Bar (hollow) .....
131006	21067	Presser Bar Bushing (lower) .....
1133AL	21067	Presser Bar Bushing (lower) Set Screw.....
38456	21067	Presser Bar Bushing (upper) .....
1133AL	21067	Presser Bar Bushing (upper) Set Screw.....
131401	21067	Presser Bar Lifting Bracket with 453AL....
11173	21067	Presser Bar Lifting Bracket Guide .....

No.	Plate	Name
453AL	21067	Presser Bar Lifting Bracket Guide Set Screw.....
453AL	21067	Presser Bar Lifting Bracket Set Screw.....
131402	21065	Presser Bar Lifting Lever.....
68184	21065	Presser Bar Lifting Lever Extension.....
161J	21065	Presser Bar Lifting Lever Extension Screw (2) .....
802D	21065	Presser Bar Lifting Lever Hinge Screw ....
131749	21065	Presser Bar Spring .....
131750	21065	Presser Bar Spring (auxiliary) .....
131751	21065	Presser Bar Spring Screw Stud.....
1637J	21065	Presser Bar Spring Screw Stud Lock Nut ...
38468	21065	Presser Bar Spring Stud.....
131830	21065	Presser Bar Spring complete, Nos. 1637J, 51697W, 131749, 131750, 131751 and 131752.....
134337	21033	Presser Foot Extension with two 62527.....
128734	21033	Presser Foot Extension Connection (left)...
1145J	21033	Presser Foot Extension Connection (left) Hinge Screw.....
128864	21033	Presser Foot Extension Connection (right)
1145J	21033	Presser Foot Extension Connection (right) Hinge Screw.....
62527	21033	Presser Foot Extension Hinge Pin (2).....
18055	21033	Presser Foot Hinge Pin.....
134338	-----	Presser Foot Plate.....
190J	21067	Presser Foot Screw .....
134339	-----	Presser Foot Shank with 316F and 1700J....
316F	21033	Presser Foot Shank Adjusting Screw .....
1700J	21033	Presser Foot Shank Adjusting Screw Nut....
39443	21033	Presser Foot Spring (2).....
134340	21033	Presser Foot (hinged extension and hinged plate) complete, for 9/16 in. to 1 in. gauges, for obtaining a smooth finish on broadcloth and similar materials, for 134343 and 134344, Nos. 18055, 128734, 128864, 134337, 134338, 134339 and two each 1145J and 39443.....
		NOTE: When ordering No. 134340, state gauge required.
51697W	21064	Pressure Regulating Thumb Nut .....
131752	21064	Pressure Regulating Thumb Nut Washer....
131403	21067	Slack Thread Regulator.....
131404	21067	Slack Thread Regulator Holder .....
131405	21067	Slack Thread Regulator Holder Crank with 171AL.....
1423J	21067	Slack Thread Regulator Holder Crank Cap Screw .....
171AL	21067	Slack Thread Regulator Holder Crank Clamping Screw .....
131406	21067	Slack Thread Regulator Holder Crank Connecting Link.....
217J	21067	Slack Thread Regulator Screw.....

## PARTS FOR MACHINE No. 152-11

No.	Plate	Name
131012	21069	Tension (under thread) Bracket.....
691F	21069	Tension (under thread) Bracket Screw.....
2102	21069	Tension (under thread) Disc (4).....
51570C	21069	Tension (under thread) Regulating Thumb Nut (2).....
50326C	21069	Tension (under thread) Screw Stud (2).....
59539	-----	Tension (under thread) Screw Stud 50326C with 51570C (2).....
131740	21069	Tension (under thread) Spring (2).....
59537	21069	Tension (under thread) Spring Bushing (large) (2).....
59538	21069	Tension (under thread) Spring Bushing (small) (2).....
131696	21069	Tension (under thread) Thread Guide (double) (2).....
54070	21069	Tension (upper thread) Bracket.....
376J	21069	Tension (upper thread) Bracket Screw.....
2102	21069	Tension (upper thread) Disc (4).....
51570C	21069	Tension (upper thread) Regulating Thumb Nut (2).....
32572	21069	Tension (upper thread) Releasing Disc (2).....
54988	21069	Tension (upper thread) Releasing Pin (2).....
54071	21069	Tension (upper thread) Releasing Shaft.....
54047	21069	Tension (upper thread) Releasing Shaft Crank with 624AL.....
54048	21069	Tension (upper thread) Releasing Shaft Crank Link.....
624AL	21069	Tension (upper thread) Releasing Shaft Crank Set Screw.....
68261	21069	Tension (upper thread) Releasing Shaft Spring.....
131011	21069	Tension (upper thread) Releasing Shaft Spring Position Plate.....
316C	21069	Tension (upper thread) Releasing Shaft Stop Screw.....
1547C	21069	Tension (upper thread) Releasing Shaft Stop Screw Nut.....
50326C	21069	Tension (upper thread) Screw Stud (2).....
59539	-----	Tension (upper thread) Screw Stud 50326C with 51570C (2).....
131741	21069	Tension (upper thread) Spring (2).....
59537	21069	Tension (upper thread) Spring Bushing (large) (2).....
59538	21069	Tension (upper thread) Spring Bushing (small) (2).....
131696	21069	Tension (upper thread) Thread Guide (double) (2).....
53225	21069	Thread (under) Eyelet (back).....
190J	21069	Thread (under) Eyelet (back) Screw.....
131407	21063	Thread (under) Take-up with 1258AL.....
131408	21063	Thread (under) Take-up Oil Guard.....
50438J	21063	Thread (under) Take-up Oil Guard Screw.....
1258AL	21063	Thread (under) Take-up Set Screw.....
131824	21063	Thread (under) Take-up Stripper.....

## PARTS FOR MACHINE No. 152-11

No.	Plate	Name
54242	21063	Thread (under) Take-up Stripper Clamp....
190J	21063	Thread (under) Take-up Stripper Clamp Screw (2).....
131825	21063	Thread (under) Take-up Stripper Plate.....
131411	21063	Thread (under) Take-up Stripper Plate Bracket.....
131934	-----	Thread (under) Take-up Stripper Plate Bracket 131411 with 32062, 50438J, 54242, 131408, 131413, 131414, 131415, 131824, 131825, two each 207J, 7071, 50470J and four 190J.....
965D	21063	Thread (under) Take-up Stripper Plate Bracket Screw.....
190J	21063	Thread (under) Take-up Stripper Plate Screw (2).....
32062	21063	Thread (under) Take-up Stripper Washer....
131413	21063	Thread (under) Take-up Thread Guard (fiber).....
50470J	21063	Thread (under) Take-up Thread Guard Screw (2).....
131414	21063	Thread (under) Take-up Thread Guide (left).....
207J	21063	Thread (under) Take-up Thread Guide (left) Screw.....
7071	21063	Thread (under) Take-up Thread Guide (left) Screw Washer.....
131415	21063	Thread (under) Take-up Thread Guide (right).....
207J	21063	Thread (under) Take-up Thread Guide (right) Screw.....
7071	21063	Thread (under) Take-up Thread Guide (right) Screw Washer.....
128721	21069	Thread (upper) Eyelet.....
190J	21069	Thread (upper) Eyelet Screw.....
131499	21067	Thread (upper) Take-up with 223J.....
223J	21067	Thread (upper) Take-up Clamping Screw.....
131495	21069	Thread (upper) Take-up (auxiliary).....
131496	21069	Thread (upper) Take-up (auxiliary) Clamp.....
997J	21069	Thread (upper) Take-up (auxiliary) Clamp Screw.....
134343	21033	Throat Plate (raised in front of needle holes to reduce feeding before material is stitched) for 11/16 and 3/4 in. gauges, for broadcloth and similar materials, for 134333.....
134344	21033	Throat Plate (raised in front of needle holes to reduce feeding before material is stitched) for 7/8 in. and 1 in. gauges, for broadcloth and similar materials, for 134334.....
134304	21066	NOTE: When ordering Throat Plates, state gauge required. Throat Plate Holder with two 1036AL.....

No.	Plate	Name
134318	-----	Throat Plate Holder 134304 with 181E and 134316.....
1396D	21066	Throat Plate Holder Screw.....
1036AL	21066	Throat Plate Leveling Screw (2).....
1011F	21033	Throat Plate Screw (2).....
1198C	21064	Throat Plate Supporting Screw (2).....

## ACCESSORIES

No.	Plate	Name
120344	21031	Oiler (copper plated) with 120345.....
120345	21031	Oiler Spout, 5 in. long.....
120440	21031	Screw Driver (large).....
121108	21031	Screw Driver (small).....
38487	21031	Threading Wire.....
120341	21031	Tweezers (curved).....
4822	21031	Wrench for 1547.....
8908	21031	Wrench for 1520.....

## BELT GUARDS

BELT GUARD 68222  
FOR USE WITH MACHINE BASE 131264

No.	Plate	Name
68222	21032	Belt Guard with two wood screws 1 in. No. 12 F.H.....

BELT GUARD 131239  
FOR USE WITH MACHINE BASES 131674 and 131919

No.	Plate	Name
131239	21032	Belt Guard with two wood screws 1 in. No. 12 F.H.....

## BENCH STANDS

BENCH STAND 79772  
FOR USE WITH MACHINE BASE 131264

No.	Plate	Name
79772	-----	Bench Stand with 27998, two each 41538, 126849, three wood screws 1 1/4 in. No. 12 F.H., four each 60656, wood screws 1 1/4 in. No. 10 F.H., eight wood screws 5/8 in. No. 6 F.H. and sixteen wood screws 5/8 in. No. 7 F.H..
126849	21031	Flap Hinge with four wood screws 5/8 in. No. 7 F.H.....
27998	21031	Flap Hook and Eye (large) brass with wood screw 1/2 in. No. 5 F.H.....
126247	21031	Flush Bolt.....
126248	21031	Flush Bolt Plate.....
41538	-----	Flush Bolt with Plate complete, Nos. 126247, 126248 and four brass wood screws 5/8 in. No. 4 F.H.....
60656	21031	Hinge.....

BENCH STAND 135115  
FOR USE WITH MACHINE BASE 131671

No.	Plate	Name
135115	-----	Bench Stand with 27998, 60220 and four each 126849 and wood screws 1 1/2 in. No. 10 F.H.....
126849	21031	Flap Hinge with four wood screws 5/8 in. No. 7 F.H.....
27998	21031	Flap Hook and Eye (large) brass with wood screw 1/2 in. No. 5 F.H.....
60220	21031	Flap Hook and Eye (small) brass with wood screw 5/8 in. No. 4 F.H.....

## FITTINGS

For Shirt Centering and for Button Staying when both operation are to be made on same machine by changing attachment.

No.	Plate	Name
134333	21034	Feed Dog, 21 teeth (16 teeth to the inch) for 11/16 in. and 3/4 in. gauges.....
134334	21034	Feed Dog, 21 teeth (16 teeth to the inch) for 7/8 in. and 1 in. gauges.....
18055	21034	Presser Foot Hinge Pin.....
134335	-----	Presser Foot Plate.....
134298	-----	Presser Foot Shank with 440J and 1700J ...
440J	21034	Presser Foot Shank Adjusting Screw.....
1700J	21034	Presser Foot Shank Adjusting Screw Nut...
134336	21034	Presser Foot (hinged) complete, for 3/4 in. to 1 in. gauges, Nos. 18055, 134298 and 134335.....
134341	21034	Throat Plate (flat) for 11/16 in. and 3/4 in. gauges, for 134333.....
134342	21034	Throat Plate (flat) for 7/8 in. and 1 in. gauges, for 134334.....

## FOR BUTTON STAYING AND PLAIN STITCHING

No.	Plate	Name
134345	21035	Feed Dog, 21 teeth (16 teeth to the inch) for 9/16 in. to 11/16 in. gauges, for 134355.....
134261	21035	Feed Dog, 16 teeth (16 teeth to the inch) for 3/4 in. and 13/16 in gauges.....
134262	21036	Feed Dog, 16 teeth (16 teeth to the inch) for 7/8 in. to 1 1/16 in gauges, for 134301.....
134263	21036	Feed Dog, 16 teeth (16 teeth to the inch) for 1 1/8 in. to 1 1/4 in. gauges, for 134302.....
134264	21037	Feed Dog, 16 teeth (16 teeth to the inch) for 1 5/16 in. to 1 1/2 in. gauges, for 134303.....
18055	21035	Presser Foot Hinge Pin.....
134353	-----	Presser Foot Plate.....
134298	-----	Presser Foot Shank with 440J and 1700J ...
440J	21035	Presser Foot Shank Adjusting Screw.....
1700J	21035	Presser Foot Shank Adjusting Screw Nut...
134354	21035	Presser Foot (hinged) complete, for 9/16 in. to 11/16 in. gauges, for 134345, Nos. 18055, 134298 and 134353.....
18055	21035	Presser Foot Hinge Pin.....

## FITTINGS

No.	Plate	Name
134322	-----	Presser Foot Plate.....
134298	-----	Presser Foot Shank with 440J and 1700J.....
440J	21035	Presser Foot Shank Adjusting Screw.....
1700J	21035	Presser Foot Shank Adjusting Screw Nut.....
134323	21035	Presser Foot (hinged) complete, for 11/16 in. to 1 1/2 in. gauges, for 134261 to 134264, Nos. 18055, 134298 and 134322..
134355	21035	Throat Plate, for 9/16 in. to 11/16 in. gauges, for 134345.....
134300	21035	Throat Plate, for 3/4 in. and 13/16 in. gauges for 134261.....
134301	21036	Throat Plate, for 7/8 in. to 1 1/16 in. gauges, for 134262.....
134302	21036	Throat Plate, for 1 1/8 in. to 1 1/4 in. gauges for 134263.....
134303	21037	Throat Plate, for 1 5/16 in. to 1 1/2 in. gauges, for 134264.....

## FOOT LIFTER PARTS

No.	Plate	Name
6439	-----	Chain, 36 in. to 45 in., with 56864 and 56865.....
		NOTE: When ordering No. 6439, state length required.
4879	21032	Chain Connecting Link.....
56864	21031	Chain Hook (large).....
56865	21031	Chain Hook (small).....
126249	21032	Treadle.....
4882	21032	Treadle Shaft.....
126250	21032	Treadle Spring.....
150451	21032	Treadle Stand.....
150452	21032	Treadle complete, Nos. 4879, 4882, 126249, 126250, 150451 and two wood screws 1 in. No. 16 F.H.....

## KNEE LIFTER PARTS

No.	Plate	Name
37563	-----	Chain, length 15 in., with 56864 and 56865 .
56864	21031	Chain Hook (large).....
56865	21031	Chain Hook (small).....
2763	21032	Rock Shaft.....

KNEE LIFTER PARTS

No.	Plate	Name
12242	21032	Rock Shaft Hanger with two wood screws 1 in. No. 10 F.H. (2).....
6335	21032	Rock Shaft Knee Arm with 1509E.....
6336	-----	Rock Shaft Knee Arm complete, Nos. 2766, 2767 and 6335.....
2766	21032	Rock Shaft Knee Arm Hub with 356C.....
356C	21032	Rock Shaft Knee Arm Hub Set Screw.....
1509E	-----	Rock Shaft Knee Arm Lock Nut.....
2767	21032	Rock Shaft Knee Plate with 356C.....
356C	21032	Rock Shaft Knee Plate Set Screw.....
6337	21032	Rock Shaft Lifting Bracket with two 356C..
7125	21032	Rock Shaft Lifting Bracket Hook.....
356C	21032	Rock Shaft Lifting Bracket Hook Set Screw..
356C	21032	Rock Shaft Lifting Bracket Set Screw.....
2770	21032	Rock Shaft Stop Dog with 140219C.....
140219C	21032	Rock Shaft Stop Dog Set Screw.....
23767	21032	Rock Shaft complete, Nos. 2763, 2770, 6336, 6337, 7125 and two 12242.....

MACHINE BASES

MACHINE BASE 131264  
WHEN MACHINE IS MOUNTED ON TOP OF TABLE  
FOR USE WITH BENCH STAND 79772

No.	Plate	Name
131263	21038	Machine Base.....
54477	21038	Machine Base Screw Stud, to fasten base to table (3).....
131205	21038	Machine Base Screw Stud, to position Machine on base (4).....
131022	21038	Machine Base Screw Stud Bushing (rubber) (4).....
51576E	21038	Machine Base Screw Stud Nut (3).....
9842	21038	Machine Base Screw Stud Nut Washer (3)..
131279	21038	Machine Cushion (felt) (4).....
131264	21038	Machine Base complete, for 131328, Nos. 131263, three each 9842, 51576E, 54477 and four each 131205 and 131279.....
131328	21038	Machine Base and Oil Drain Jar (Swinging type) complete, for mounting on top of table, Nos. 131264 and 131268.....

MACHINE BASE 131919  
FOR SEMI-SUBMERGED INSTALLATION  
FOR USE WITH BENCH STAND 135115

No.	Plate	Name
131918	21070	Machine Base.....
51428R	21070	Machine Base Bolt with 1778R.....
1778R	21070	Machine Base Bolt Nut.....
126150	21070	Machine Base Bolt Nut Lock Washer.....
69353	-----	Machine Base Bolt complete, Nos. 51428R, and 126150.....
131205	21070	Machine Base Screw Stud to position Machine on Base (4).....
131022	21070	Machine Base Screw Stud Bushing (rubber) (4).....
131279	21070	Machine Cushion (felt) (4).....
131919	21070	Machine Base complete for 131920, Nos. 131918 and four each 131205, 131279 and 151141.....
131920	21070	Machine Base and Oil Drain Jar (swinging type) complete for semi-submerged installation, Nos. 131268 and 131919....

MACHINE BASE 131674  
FOR FULLY-SUBMERGED INSTALLATION

No.	Plate	Name
131673	21040	Machine Base.....
51428R	21040	Machine Base Bolt with 1778R.....
1778R	21040	Machine Base Bolt Nut.....
126150	21040	Machine Base Bolt Nut Lock Washer.....
69353	-----	Machine Base Bolt complete, Nos. 51428R and 126150 (4).....
131205	21040	Machine Base Screw Stud to position Machine on Base (4).....
131022	21040	Machine Base Screw Stud Bushing (rubber) (4).....
131279	21040	Machine Cushion (felt) (4).....
131674	21040	Machine Base complete for 131675, Nos. 131673 and four each 69353, 131205 and 131279.....
131675	21040	Machine Base and Oil Drain Jar (swinging type) complete for fully submerged installation, Nos. 131268 and 131674....

MACHINE BASE OIL DRAIN JAR  
(SWINGING TYPE)

No.	Plate	Name
131961	21038	Jar (glass).....
131962	21038	Jar Cap .....
131188	21038	Jar Clamp .....
131217	-----	Jar Clamp 131188 with 131189.....
131189	21038	Jar Clamp Lever .....
1247AL	21038	Jar Clamp Lever Hinge Screw (2).....
131265	21038	Nipple (long) (2).....
131266	21038	Nipple (short).....
131267	21038	Nipple Elbow (2).....
131268	21038	Machine Base Oil Drain Jar (swinging type) complete, Nos. 131217, 131266, 131961, 131962 and two each 1247AL, 131265 and 131267 .....

STRIP FOLDERS

STRIP FOLDER ON BRACKET

No.	Plate	Name
121100	21071	Strip Folder .....
121101	21071	Strip Folder Bracket.....
957F	21071	Strip Folder Bracket Hinge Screw .....
173F	21071	Strip Folder Bracket Screw.....
19047	21071	Strip Folder Bracket Screw Washer.....
121102	21071	Strip Folder with Bracket complete, for shirt centers, Nos. 121100, 121101 and two each 22436 and 50473F.....
50473F	21071	Strip Folder Screw.....
22436	21071	Strip Folder Screw Washer .....
121103	21071	Strip Folder Throw-out Arm with 1148F and 1698F .....
121104	21071	Strip Folder Throw-out Arm Bracket .....
1343E	21071	Strip Folder Throw-out Arm Bracket Screw .....
9842	21071	Strip Folder Throw-out Arm Bracket Screw Washer .....
50581F	21071	Strip Folder Throw-out Arm Clamping Screw .....
14017	21071	Strip Folder Throw-out Arm Clamping Screw Washer .....
80F	21071	Strip Folder Throw-out Arm Hinge Screw .....
36006	21071	Strip Folder Throw-out Arm Hinge Screw Friction Washer .....
1148F	21071	Strip Folder Throw-out Arm Stop Screw....
1698F	21071	Strip Folder Throw-out Arm Stop Screw Lock Nut .....
121256	21071	Strip Folder Throw-out Arm with Bracket complete, for 121102, Nos. 80F, 173F, 957F, 14017, 19047, 36006, 50581F, 121103 and 121104 .....

FOR BLUFF CENTERS

No.	Plate	Name
121693	21042	Bluff Center Attachment on Shank with 43525.....
121694	21042	Bluff Center Attachment Hinge Bracket.....
56318	21042	Bluff Center Attachment Hinge Bracket Hinge Pin.....
121695	21042	Bluff Center Attachment Hinge Bracket Locking Lever.....
1425B	21042	Bluff Center Attachment Hinge Bracket Locking Lever Screw.....
2749	21042	Bluff Center Attachment Hinge Bracket Locking Lever Screw Washer .....
43525	21042	Bluff Center Attachment Hinge Bracket Locking Lever Stop Pin.....
964B	21042	Bluff Center Attachment Screw .....
120957	21042	Bluff Center Attachment on Shank (hinged) with Locking Device complete, Nos. 1425B, 2749, 56318 and 121693 to 121695.

EDGE FOLDERS ON SHANK

No.	Plate	Name
134329	21064	Cloth Plate Slide.....
134330	21064	Cloth Plate Slide Spring (back).....
134305	21064	Cloth Plate Slide Spring (side) .....
665J	21064	Cloth Plate Slide Spring Screw .....
134331	21064	Cloth Plate Slide complete, Nos. 134329, 134330, two 134305 and six 665J.....
120549	21042	Edge Folder on Shank, for turning the right hand edge under, for button or button hole facings .....
120640	21071	Edge Folder on Shank (left) for starting from bottom of garment when attaching center.....
120641	21071	Edge Folder on Shank (right) for starting from neck of garment when attaching center.....
1423J	21071	Edge Folder Screw (2).....

## STRIP FOLDER ON SHANK

No.	Plate	Name
120701	21042	Strip Folder on Shank for under facing* strips, for button or button hole facing*..
134329	21064	Cloth Plate Slide .....
134330	21064	Cloth Plate Slide Spring (back).....
134305	21064	Cloth Plate Slide Spring (side).....
665J	21064	Cloth Plate Slide Spring Screw.....
134331	21064	Cloth Plate Slide complete, Nos. 134329, 134330, two 134305 and six 665J .....
1423J	21042	Strip Folder Screw .....

## THREAD UNWINDER

## FOR FOUR SPOOLS

No.	Plate	Name
228764	24513	Spool Pin (4).....
228766	24513	Spool Rest (for two spools) with 201254C (2) .....
150203	24513	Spool Rest Cushion (felt) (4).....
228767	24513	Spool Rest Rod .....
201254C	24513	Spool Rest Set Screw.....
228768	24513	Spool Stand .....
228769	24513	Thread Guide (4) .....
228772	24513	Thread Guide Holder.....
228774	24513	Thread Guide Rod .....
150058	24513	Thread Separator.....
150060	24513	Thread Separator Bracket Arm with 164J and 9525.....
164J	24513	Thread Separator Bracket Arm Clamping Screw .....
9525	24513	Thread Separator Bracket Arm Clamping Screw Washer.....
164J	24513	Thread Separator Bracket Arm Screw .....
9525	24513	Thread Separator Bracket Arm Screw Washer.....
150061	-----	Thread Separator complete, Nos. 164J, 9525, 150058 and 150060 .....
150062	24513	Thread Unwinder complete, for four spools, Nos. 150061, 228767, 228768, 228772, 228774, two 228766, three wood screws 7/8 in. No. 12 F.H. and four each 150203, 228764 and 228769 .....
27739	24513	Thread Cone (wood) for large cones.....
225390	24513	Thread Cone Holder, for inverted cones
NOTE: Nos. 27739 and 225390 are used with, but not included in 150062 .....		

## NUMERICAL LIST OF PARTS

No.	Plate	Name
80F	21071	Strip Folder Throw-out Arm Hinge Screw for 121256.....
144D	21063	Arm Rotary Shaft Screw .....
157J	21033	Feed Dog Screw .....
161J	21065	Presser Bar Lifting Lever Extension Screw.
164J	24513	Thread Unwinder Thread Separator Bracket Arm Clamping Screw for 150060.....
164J	24513	Thread Unwinder Thread Separator Bracket Arm Screw for 150061 .....
171AL	21067	Slack Thread Regulator Holder Crank Clamping Screw for 131405 .....
173F	21071	Strip Folder Bracket Screw for 121256 .....
175AL	21027	Looper Clamping Screw for 134268 and 134269 .....
175AL	21066	Looper Driver Cap Screw for 68479 .....
175AL	21027	Looper Holder Connection Hinge Stud Clamping Screw for 134272 .....
176J	21033	Needle Guard Holder Screw .....
176E	21068	Oil Pipe (back of arm) Clamp Screw .....
181E	21066	Feed Bar Position Plate Screw for 134318 ..
190J	21067	Presser Foot Screw.....
190J	21069	Thread (under) Eyelet (back) Screw.....
190J	21063	Thread (under) Take-up Stripper Clamp Screw for 131934.....
190J	21063	Thread (under) Take-up Stripper Plate Screw for 131934.....
190J	21069	Thread (upper) Eyelet Screw .....
198E	21068	Oil Pipe (back of arm) Connection Cap Screw for 68494.....
198E	21068	Oil Pipe (front of arm) Connection Cap Screw for 131003 and 134295 .....
205C	21063	Arm Rotary Shaft Ball Bearing (back) Case Cap Screw for 131479.....
207E	21066	Feed Bar Wearing Plate Screw for 134390 ..
207J	21063	Thread (under) Take-up Thread Guide (left) Screw for 131934.....
207J	21063	Thread (under) Take-up Thread Guide (right) Screw for 131934 .....
211E	21066	Feed Bar Guide Screw for 134390.....
217J	21063	Feed Eccentric Clamping Washer Screw for 54025 .....
217J	21033	Needle Guard Screw .....
217J	21067	Slack Thread Regulator Screw .....
219J	21027	Looper Throw-out Slide Block Bracket Gib (left) Screw, for 134307 .....
219J	21027	Looper Throw-out Slide Block Bracket Gib (right) Screw, for 134307 .....
223J	21067	Thread (upper) Take-up Clamping Screw for 131499.....
316C	21069	Tension (upper thread) Releasing Shaft Stop Screw .....

No.	Plate	Name
316F	21033	Presser Foot Shank Adjusting Screw for 134339.....
330D	21065	Face Plate (lower half) Screw.....
356C	21032	Rock Shaft Knee Arm Hub Set Screw for 2766 .....
356C	21032	Rock Shaft Knee Plate Set Screw for 2767...
356C	21032	Rock Shaft Lifting Bracket Hook Set Screw for 6337 .....
356C	21032	Rock Shaft Lifting Bracket Hook Set Screw for 6337 .....
376J	21069	Tension (upper thread) Bracket Screw .....
389F	21064	Cloth Plate Thread Guard Screw (lower) ...
423AL	21062	Arm Rock Shaft Bushing (intermediate) Set Screw .....
429C	21063	Arm Rotary Shaft Ball Bearing (back) Case Set Screw .....
435AL	21027	Looper Throw-out Crank Compression Plate Hinge Stud Set Screw.....
440J	21034	Presser Foot Shank Adjusting Screw for 134298 .....
446AL	21062	Arm Rock Shaft Bushing (back) Set Screw ..
453AL	21062	Arm Rock Shaft Flanged Bushing Set Screw ..
453AL	21066	Feed Rocking Frame Hinge Pin Bushing Set Screw for 131240 .....
453AL	21066	Feed Rocking Frame Hinge Pin Set Screw ..
453AL	21067	Presser Bar Lifting Bracket Guide Set Screw .....
453AL	21067	Presser Bar Lifting Bracket Set Screw for 131401 .....
457AL	21063	Arm Rotary Shaft Ball Bearing (intermediate) Collar Set Screw for 131482
462AL	2107	Looper Throw-out Crank Handle Set Screw for 134277 .....
624AL	21069	Tension (upper thread) Releasing Shaft Crank Set Screw for 54047.....
640E	21066	Looper Driving Shaft and Feed Lifting Eccentric Screw for 134357.....
665J	21064	Cloth Plate Slide Spring Screw for 134331 ..
691F	21069	Tension (under thread) Bracket Screw .....
735AL	21066	Feed Bar Hinge Pin Collar Set Screw for 59343.....
761E	21063	Arm Rotary Shaft Bushing (front) Set Screw
761E	21066	Looper Driving Shaft and Feed Lifting Eccentric Bushing Position Screw for 68483 .....
802D	21065	Presser Bar Lifting Lever Hinge Screw....
853AL	21062	Needle Bar Connecting Link Hinge Stud Set Screw for 131475 .....
861C	21067	Needle Bar Connecting Link Hinge Stud Oil Plug Screw.....
896AL	21063	Feed Connecting Rod Cap Screw for 131500 ..
957F	21071	Strip Folder Bracket Hinge Screw for 121256 .....
964B	21042	Bluff Center Attachment Screw.....

No.	Plate	Name
965D	21063	Thread (under) Take-up Stripper Plate Bracket Screw.....
997J	21069	Thread (upper) Take-up (auxiliary) Clamp Screw .....
1011F	21064	Cloth Plate Screw (left) .....
1011F	21033	Throat Plate Screw .....
1036AL	21066	Throat Plate Leveling Screw for 134304....
1053E	21065	Face Plate (upper half) Position Plate Screw
1057AL	21065	Arm Bottom Cover Screw.....
1057AL	21065	Arm Side Cover Screw .....
1057AL	21063	Crank Connecting Rod Cap (upper) Screw for 131926 .....
1057AL	21063	Feed Connecting Rod Clamping Screw for 131500 .....
1103C	21063	Feed Regulating Screw for 54025 .....
1133AL	21067	Needle Bar Bushing (lower) Set Screw .....
1133AL	21067	Needle Bar Bushing (upper) Set Screw .....
1133AL	21067	Presser Bar Bushing (lower) Set Screw....
1133AL	21067	Presser Bar Bushing (upper) Set Screw....
1145J	21033	Presser Foot Extension Connection (left) Hinge Screw for 134340.....
1145J	21033	Presser Foot Extension Connection (right) Hinge Screw for 134340.....
1148F	21071	Strip Folder Throw-out Arm Stop Screw for 121103 .....
1198C	21064	Throat Plate Supporting Screw for 134359 ..
1235F	21062	Arm Rock Shaft Oil Plug Screw for 131474 ..
1247AL	21038	Machine Base Oil Jar Clamp Lever Hinge Screw for 131268 .....
1258AL	21063	Thread (under) Take-up Set Screw for 131407 .....
1289X	21065	Arm Side Cover Cap Thumb Screw for 131911 .....
1304C	21063	Arm Rotary Shaft Ball Bearing (intermediate) Case Set Screw .....
1309C	21062	Arm Rock Shaft Adjusting Screw.....
1343E	21071	Strip Folder Throw-out Arm Bracket Screw ..
1396D	21027	Looper Throw-out Slide Block Bracket (left) Screw .....
1396D	21027	Looper Throw-out Slide Block Bracket (right) Screw.....
1396D	21066	Throat Plate Holder Screw.....
1423J	21067	Slack Thread Regulator Holder Crank Cap Screw .....
1423J	21071	Edge Folder Screw.....
1423J	21042	Strip Folder Screw.....
1425B	21042	Bluff Center Attachment Hinge Bracket Locking Lever Screw for 120957.....
1454C	21027	Looper Holder Connection Hinge Stud Cap Screw for 134308 and 134309.....
1492E	21067	Needle Bar Connecting Stud Clamping Screw for 131492 .....
1509E	----	Rock Shaft Knee Arm Lock Nut.....
1520J	21067	Needle Bar Connecting Link Hinge Stud Nut ..



No.	Plate	Name
1547J	21069	Tension (upper thread) Releasing Shaft Stop Screw Nut.....
1620R	21064	Cloth Plate Supporting Post Lock Nut.....
1637J	21065	Presser Bar Spring Screw Stud Lock Nut for 131830 .....
1651E	21027	Looper Holder Hinge Screw Nut for 134308 and 134309 .....
1698F	21071	Strip Folder Throw-out Arm Stop Screw Lock Nut for 121103.....
1700J	21033	Presser Foot Shank Adjusting Screw Nut for 134298 and 134339 .....
1733	21068	Oil Pipe (back of arm) Coupling Nut (brass)
1733	21068	Oil Pipe (front of arm) Coupling Nut (brass)
1778R	21070	Machine Base Bolt Nut for 51428R .....
2102	21069	Tension (under thread) Disc.....
2102	21069	Tension (upper thread) Disc.....
2749	21042	Bluff Center Attachment Hinge Bracket Locking Lever Screw Washer for 120957.
2763	21032	Rock Shaft for 23767.....
2766	21032	Rock Shaft Knee Arm Hub with 356C for 6336.....
2767	21032	Rock Shaft Knee Plate with 356C for 6336..
2770	21032	Rock Shaft Stop Dog with 140219C, for 23767.....
4822	21031	Wrench for 1547 (Accessories).....
4879	21032	Chain Connecting Link for 150452.....
4882	21032	Treadle Shaft for 150452.....
6335	21032	Rock Shaft Knee Arm with 1509E, for 6336.
6336	-----	Rock Shaft Knee Arm complete, Nos. 2766, 2767 and 6335.....
6337	21032	Rock Shaft Lifting Bracket with two 356C, for 23767.....
6439	-----	Chain, 36 in. to 45 in., with 56864 and 56865.....
7071	21063	Feed Eccentric Clamping Washer for 54025
7071	21063	Thread (under) Take-up Thread Guide (left) Screw Washer for 131934.....
7071	21063	Thread (under) Take-up Thread Guide (right) Screw Washer for 131934.....
7125	21032	Rock Shaft Lifting Bracket Hook for 23767 .
8908	21031	Wrench for 1520 (Accessories).....
9525	24513	Thread Unwinder Thread Separator Bracket Arm Clamping Screw Washer for 150060.
9525	24513	Thread Unwinder Thread Separator Bracket Arm Screw Washer for 150061.....
9842	21038	Machine Base Screw Stud Nut Washer for 131264 .....
9842	21071	Strip Folder Throw-out Arm Bracket Screw Washer .....
11173	21067	Presser Bar Lifting Bracket Guide.....
12242	21032	Rock Shaft Hanger with two wood screws 1 in. No. 10 F.H. for 23767.....
14017	21071	Strip Folder Throw-out Arm Clamping Screw Washer for 121256 .....

No.	Plate	Name
18055	21033	Presser Foot Hinge Pin for 134323, 134336, 134340 and 134354.....
18413	21027	Looper Throw-out Crank Compression Plate Spring.....
19047	21071	Strip Folder Bracket Screw Washer for 121256.....
22436	21071	Strip Folder Screw Washer for 121102.....
23767	21032	Rock Shaft complete, Nos. 2763, 2770, 6336, 6337, 7125 and two 12242.....
26276	21027	Looper Throw-out Crank Compression Plate Hinge Pin for 134275.....
27739	24513	Thread Unwinder Thread Cone (wood) for large cones for 150062.....
27998	21031	Bench Stand Flap Hook and Eye (large) brass with wood screw 1/2 in. No. 5 F.H. for 79772 and 135115 .....
29234	21065	Face Plate (upper half) Position Plate.....
32062	21063	Thread (under) Take-up Stripper Washer for 131934 .....
32572	21069	Tension (upper thread) Releasing Disc .....
36006	21071	Strip Folder Throw-out Arm Hinge Screw Friction Washer for 121256 .....
37563	-----	Chain, length 15 in., with 56864 and 56865..
38456	21067	Presser Bar Bushing (upper).....
38468	21065	Presser Bar Spring Stud.....
38487	21031	Threading Wire (Accessories).....
39443	21033	Presser Foot Spring for 134340.....
41538	-----	Bench Stand Flush Bolt with Plate complete, Nos. 126247, 126248 and four brass wood screws 5/8 in. No. 4 F.H., for 79772....
42365	21062	Arm Rock Shaft Oil Pad for oiling Back Bearing.....
42367	21068	Arm Rotary Shaft Front Bearing Oil Pad, lower (braided cotton).....
43525	21042	Bluff Center Attachment Hinge Bracket Locking Lever Stop Pin for 121693.....
50326C	21069	Tension (under thread) Screw Stud for 59539 .....
50326C	21069	Tension (upper thread) Screw Stud for 59539 .....
50379F	21067	Needle Set Screw for 134286.....
50396F	21064	Cloth Plate Screw (right) .....
50429AL	21066	Feed Eccentric Body Set Screw for 54025...
50438J	21063	Thread (under) Take-up Oil Guard Screw for 131934.....
50464C	21027	Looper Holder Hinge Screw for 134308 and 134309 .....
50470J	21063	Thread (under) Take-up Thread Guard Screw for 131934.....
50473F	21064	Cloth Plate Thread Guard Screw (upper)....
50473F	21071	Strip Folder Screw for 121102.....
50581F	21071	Strip Folder Throw-out Arm Clamping Screw for 121256.....

No.	Plate	Name
50608R	21065	Arm Hole Plug Screw, for access to Crank Connecting Rod (upper bearing).....
51061AL	21063	Feed Eccentric Body Set Screw for 54025...
51224W	21065	Face Plate (upper half) Thumb Screw.....
51283AL	21063	Machine Pulley Set Screw, for 131914.....
51407AL	21063	Arm Rod Shaft Crank (back) Set Screw for 131343.....
51422J	21066	Looper Driving Shaft and Feed Lifting Eccentric Bracket Screw for 134356.....
51428R	21070	Machine Base Bolt with 1778R, for 69353....
51570C	21069	Tension (under thread) Regulating Thumb Nut for 59539.....
51570C	21069	Tension (upper thread) Regulating Thumb Nut for 59539.....
51576E	21038	Machine Base Screw Stud Nut for 131264....
51697W	21064	Pressure Regulating Thumb Nut for 131830..
51715AL	21063	Crank Connecting Rod Cap (lower) Nut for 131926.....
53225	21069	Thread (under) Eyelet (back).....
54025	21063	Feed Eccentric (adjustable) complete for 131502.....
54047	21069	Tension (upper thread) Releasing Shaft Crank with 624AL.....
54048	21069	Tension (upper thread) Releasing Shaft Crank Link.....
54070	21069	Tension (upper thread) Bracket.....
54071	21069	Tension (upper thread) Releasing Shaft.....
54218	21068	Arm Rotary Shaft Front Bearing Oil Pad, upper (braided cotton).....
54242	21063	Thread (under) Take-up Stripper Clamp for 131934.....
54477	21038	Machine Base Screw Stud, to fasten base to table, for 131264.....
54648	21066	Feed Bar Oil Pad for 134390.....
54969	21062	Arm Rock Shaft Oil Pad for oiling intermediate Bearing.....
54988	21069	Tension (upper thread) Releasing Pin.....
56318	21042	Bluff Center Attachment Hinge Bracket Hinge Pin for 120957.....
56864	21031	Chain Hook (large) for 6439 and 37563.....
56865	21031	Chain Hook (small) for 6439 and 37563.....
57234	21066	Feed Rocking Frame Hinge Pin.....
57235	21066	Feed Rocking Frame Hinge Pin Bushing....
59343	21066	Feed Bar Hinge Pin Collar with 735AL, for 134391.....
59537	21069	Tension (under thread) Spring Bushing (large).....
59537	21069	Tension (upper thread) Spring Bushing (large).....
59538	21069	Tension (under thread) Spring Bushing (small).....
59538	21069	Tension (upper thread) Spring Bushing (small).....

No.	Plate	Name
59539	-----	Tension (under thread) Screw Stud 50326C with 51570C.....
59539	-----	Tension (upper thread) Screw Stud 50326C with 51570C.....
60220	21031	Bench Stand Flap Hook and Eye (small) brass with wood screw 5/8 in. No. 4 F.H. for 135115.....
60656	21031	Bench Stand Hinge for 79772.....
62527	21033	Presser Foot Extension Hinge Pin for 134337.....
64320	21067	Needle Bar Bushing (upper).....
68184	21065	Presser Bar Lifting Lever Extension.....
68222	21032	Belt Guard with two screws 1 in. No. 12 F.H. for use with Machine Base 131264.....
68261	21069	Tension (upper thread) Releasing Shaft Spring.....
68350	21068	Arm Oil Cup, for oiling Arm Rock Shaft Front Bearing.....
68428	21065	Arm Bottom Cover.....
68429	21065	Arm Bottom Cover Gasket (cork).....
68433	21062	Arm Rock Shaft Bushing (back).....
68435	21062	Arm Rock Shaft Bushing (back) Cap.....
68436	21062	Arm Rock Shaft Bushing (intermediate)....
68448	21065	Arm Side Cover Gasket (cork).....
68467	21066	Feed Bar Wearing Plate for 134390.....
68479	21066	Looper Driver with four 175AL, for 134312..
68483	-----	Looper Driving Shaft and Feed Lifting Eccentric Bracket with 761E, for 134356..
68488	21067	Needle Bar Connecting Link and Thread (upper) Controller for 131491.....
68489	21067	Needle Bar Connecting Link Hinge Stud (hollow) for 131491.....
68492	21068	Oil Pipe (back of arm) with 68497, for oiling Feed Rocking Frame Hinge Pin Front Bearing.....
68493	21068	Oil Pipe (back of arm) Clamp.....
68494	21068	Oil Pipe (back of arm) Connection with 68495 and two 198E, for oiling Feed Rocking Frame Hinge Pin Back Bearing..
68495	21066	Feed Bar Slide Block Oil Pad (wick) for 131944.....
68495	21068	Oil Pipe (back of arm) Connection Oil Pad (wick) for 68494.....
68496	21068	Oil Pipe (back of arm) Coupling (brass)...
68497	21063	Feed Connecting Rod Oil Pad (wick) for 131500.....
68497	21066	Looper Driving Shaft and Feed Lifting Eccentric Front Bearing Oil Pad (wick)..
68497	21068	Oil Pipe (back of arm) Oil Pad (wick) for 134291.....
68497	21068	Oil Pipe (front of arm) Oil Pad (wick) for 134291, 134292, 134294 and 134362.....
69353	-----	Machine Base Bolt complete for 131919 and 131674, Nos. 51428R and 126150.....

No.	Plate	Name
79772	-----	Bench Stand with 27998, two each 41538, 126849, three wood screws 1 1/4 in. No. 12 F.H., four each 60656, wood screws 1 1/4 in. No. 10 F.H., eight wood screws 5/8 in. No. 6 F.H. and sixteen wood screws 5/8 in. No. 7 F.H., for use with Machine Base 131264.....
120341	21031	Tweezers (curved) Accessories .....
120344	21031	Oiler (copper plated) with 120345 (Accessories) .....
120345	21031	Oiler Spout, 5 in. long for 120344.....
120440	21031	Screw Driver (large) Accessories .....
120549	21042	Edge Folder on Shank, for turning the right hand edge under, for button or button hole facings .....
120640	21071	Edge Folder on Shank (left) for starting from bottom of garment when attaching center .....
120641	21071	Edge Folder on Shank (right) for starting from neck of garment when attaching center .....
120701	21042	Strip Folder on Shank for under facing strips, for button or button hole facings ..
120957	21042	Bluff Center Attachment on Shank (hinged) with Locking Device complete, Nos. 1425B, 2749, 56318 and 121693 to 121695.....
121100	21071	Strip Folder for 121102.....
121101	21071	Strip Folder Bracket for 121102 .....
121102	21071	Strip Folder with Bracket complete, for shirt centers, Nos. 121100, 121101 and two each 22436 and 50473F.....
121103	21071	Strip Folder Throw-out Arm with 1148F and 1698F, for 121256.....
121104	21071	Strip Folder Throw-out Arm Bracket for 121256.....
121108	21031	Screw Driver (small) Accessories .....
121256	21071	Strip Folder Throw-out Arm with Bracket complete, for 121102, Nos. 80F, 173F, 957F, 14017, 19047, 36006, 50581F, 121103 and 121104 .....
121693	21042	Bluff Center Attachment on Shank with 43525 for 120957 .....
121694	21042	Bluff Center Attachment Hinge Bracket for 120957 .....
121695	21042	Bluff Center Attachment Hinge Bracket Locking Lever for 120957.....
126150	21070	Machine Base Bolt Nut Lock Washer for 69353.....
126247	21031	Bench Stand Flush Bolt for 41538 .....
126248	21031	Bench Stand Flush Plate for 41538 .....
126249	21032	Treadle for 150452.....
126250	21032	Treadle Spring for 150452.....
126849	21031	Bench Stand Flap Hinge with four wood screws 5/8 in. No. 7 F.H. for 79772 and 135115 .....

No.	Plate	Name
127838	21062	Arm Rock Shaft Crank (front) Pin for 131474.....
128721	21069	Thread (upper) Eyelet.....
128734	21033	Presser Foot Extension Connection (left) for 134340 .....
128864	21033	Presser Foot Extension Connection (right) for 134340 .....
131003	21068	Oil Pipe (front of arm) Connection with two 198E, for 134291 and 134292.....
131004	21068	Oil Pipe (front of arm) Coupling (center)...
131004	21068	Oil Pipe (front of arm) Coupling (left) .....
131006	21067	Presser Bar Bushing (lower) .....
131011	21069	Tension (upper thread) Releasing Shaft Spring Position Plate.....
131012	21069	Tension (under thread) Bracket .....
131022	21038	Machine Base Screw Stud Bushing (rubber) for 131264, 131919 and 131674 .....
131028	21066	Looper Driving Shaft and Feed Lifting Eccentric Bushing Oil Screw Plug .....
131056	21062	Arm Rock Shaft Adjusting Screw Washer ...
131087	21068	Oil Pipe (front of arm) Coupling (right)....
131089	21068	Oil Pipe (front of arm) Oil Pad (wick) for 134290.....
131095	21062	Arm Rock Shaft Bushing (back) Cap Washer (fiber) .....
131188	21038	Machine Base Oil Drain Jar Clamp for 131217 .....
131189	21038	Machine Base Oil Drain Jar Clamp Lever for 131217 .....
131197	21066	Feed Bar Hinge Pin (eccentric) for 134391 ..
131205	21038	Machine Base Screw Stud, to position Machine on base, for 131264 and 131919 and 131674.....
131217	-----	Machine Base Oil Drain Jar Clamp 131188 with 131189 .....
131239	21032	Belt Guard with two wood screws 1 in. No. 12 F.H., for use with Machine Bases 131674 and 131919 .....
131240	21066	Feed Rocking Frame with two 453AL, for 134391.....
131263	21038	Machine Base for 131264 .....
131264	21038	Machine Base complete, for 131328, Nos. 131263, three each 9842, 51576E, 54477 and four each 131205 and 131279.....
131265	21038	Machine Base Oil Drain Jar Nipple (long) for 131268 .....
131266	21038	Machine Base Oil Drain Jar Nipple (short) for 131268 .....
131267	21038	Machine Base Oil Drain Jar Nipple Elbow for 131268 .....
131268	21038	Machine Base Oil Drain Jar (swinging type) complete, Nos. 131217, 131266, 131961, 131962 and two each 1247AL, 131265 and 131267 .....

## NUMERICAL LIST OF PARTS

No.	Plate	Name
131270	21067	Needle Bar Connecting Link Hinge Stud Oil Pad (wick) .....
131276	21065	Arm Side Cover (oil vent) for 131911 .....
131279	21038	Machine Cushion (felt) for 131264, 131919 and 131674 .....
131280	21065	Arm Side Cover Cap Position Pin for 131911 .....
131291	21067	Needle Bar Bushing (lower) .....
131293	21062	Arm Rock Shaft for 131474 .....
131319	21068	Arm Oil Cup Oil Pad (braided cotton) for 68350 .....
131328	21038	Machine Base and Oil Drain Jar (swinging type) complete, for mounting on top of table, Nos. 131264 and 131268 .....
131343	21063	Arm Rock Shaft Crank, back (ball bearing, solid) with two 51407AL, for 131929 .....
131366	21063	Arm Rotary Shaft Ball Bearing (back) for 131526 .....
131366	21063	Arm Rotary Shaft Ball Bearing (intermediate)
131369	21063	Arm Rotary Shaft Ball Bearing (back) Case Cap for 131479 .....
131370	21063	Arm Rotary Shaft Ball Bearing (back) Case Position Stud .....
131395	21065	Face Plate (upper half) .....
131401	21067	Presser Bar Lifting Bracket with 453AL .....
131402	21065	Presser Bar Lifting Lever .....
131403	21067	Slack Thread Regulator .....
131404	21067	Slack Thread Regulator Holder .....
131405	21067	Slack Thread Regulator Holder Crank with 171AL .....
131406	21067	Slack Thread Regulator Holder Crank Connecting Link .....
131407	21063	Thread (under) Take-up with 1258AL .....
131408	21063	Thread (under) Take-up Oil Guard for 131934 .....
131411	21063	Thread (under) Take-up Stripper Plate Bracket for 131934 .....
131413	21063	Thread (under) Take-up Thread Guard (fiber) for 131934 .....
131414	21063	Thread (under) Take-up Thread Guide (left) for 131934 .....
131415	21063	Thread (under) Take-up Thread Guide (right) for 131934 .....
131456	21062	Arm Rock Shaft Flanged Bushing (front) .....
131457	21063	Arm Rotary Shaft Bushing (front) .....
131474	-----	Arm Rock Shaft 131293 with 1235F, 127838 and 131475 .....
*131475	-----	Arm Rock Shaft Crank (front) with 853AL, for 131474 .....
*131476	21063	Arm Rotary Shaft for 134357 .....
131478	21063	Arm Rotary Shaft Ball Bearing (back) Case for 131479 .....
131479	-----	Arm Rotary Shaft Ball Bearing (back) Case 131478 with 131369 and three 205C .....

## NUMERICAL LIST OF PARTS

No.	Plate	Name
131480	21063	Arm Rotary Shaft Ball Bearing (back) Spacing Collar for 131526 .....
131481	21063	Arm Rotary Shaft Ball Bearing (intermediate) Case .....
131482	21063	Arm Rotary Shaft Ball Bearing (intermediate) Collar with two 457AL .....
131491	-----	Needle Bar Connecting Link and Thread (upper) Controller 68488 with 68489 and 131492 .....
131492	21067	Needle Bar Connecting Stud with 1492E for 131491 .....
131495	21069	Thread (upper) Take-up (auxiliary) .....
131496	21069	Thread (upper) Take-up (auxiliary) Clamp .....
131497	21067	Needle Bar (hollow), for 134361 .....
131499	21067	Thread (upper) Take-up with 223J .....
131500	21063	Feed Connecting Rod with 1057AL, 68497, 134260 and two 896AL, for 131502 .....
131502	-----	Feed Connecting Rod 131500 with 54025 .....
131526	-----	Arm Rotary Shaft Ball Bearing (back) Case with Ball Bearings complete, Nos. 131479, 131480 and two 131366 .....
131610	21064	Cloth Plate Thread Guard .....
131673	21040	Machine Base for 131674 .....
131674	21040	Machine Base complete for 131675, Nos. 131673 and four each 69353, 131205 and 131279 .....
131675	21040	Machine Base and Oil Drain Jar (swinging type) complete for fully submerged installation, Nos. 131268 and 131674 .....
131696	21069	Tension (under thread) Thread Guide (double) .....
131696	21069	Tension (upper thread) Thread Guide (double) .....
131740	21069	Tension (under thread) Spring .....
131741	21069	Tension (upper thread) Spring .....
131749	21065	Presser Bar Spring for 131830 .....
131750	21065	Presser Bar Spring (auxiliary) for 131830 .....
131751	21065	Presser Bar Spring Screw Stud 131830 .....
131752	21064	Pressure Regulating Thumb Nut Washer for 131830 .....
131824	21063	Thread (under) Take-up Stripper for 131934 .....
131825	21063	Thread (under) Take-up Stripper Plate for 131934 .....
131830	21065	Presser Bar Spring complete, Nos. 1637J, 51697W, 131749, 131750, 131751 and 131752 .....
131864	21068	Arm Oil Cup for 131866 .....
131865	21068	Arm Oil Cup Oil Gauge for 131866 .....
131866	21068	Arm Oil Cup, with Oil Gauge complete, for filling oil reservoir, Nos. 131864 and 131865 .....
131909	21065	Arm Side Cover Cap for 131911 .....
131910	21065	Arm Side Cover Cap Spring for 131911 .....

## NUMERICAL LIST OF PARTS

No.	Plate	Name
131911	-----	Arm Side Cover (oil vent) complete, Nos. 1289X, 131276, 131280, 131909 and 131910.....
131912	21067	Presser Bar (hollow) .....
131914	21063	Machine Pulley with two 51283AL.....
131918	21070	Machine Base for 131919 .....
131919	21070	Machine Base complete for 131920, Nos. 131918 and four each 131205, 131279 and 151141 .....
131920	21070	Machine Base and Oil Drain Jar (swinging type) complete for semi-submerged installation, Nos. 131268 and 131919.....
131926	21063	Crank Connecting Rod with each 1057AL, 51715AL, 131927 and 131928, for 131929. NOTE: When No. 131926 is required for repairs Connecting Rod and Arm Rock Shaft Crank (back) fitted together, will be furnished in order to obtain correct Needle Bar Stroke...
131927	21063	Crank Connecting Rod Cap (lower) Nut Stud for 131926 .....
131928	-----	Crank Connecting Rod Cap (lower) Nut Stud Nut Lock Washer, for 131926 .....
131929	-----	Crank Connecting Rod 131926 with 131343, for 134357 .....
131934	-----	Thread (under) Take-up Stripper Plate Bracket 131411 with 32062, 50438J, 54242, 131408, 131413, 131414, 131415, 131824, 131825, two each 207J, 7071, 50470J and four 190J.....
131943	21066	Feed Bar Slide Block for 131944.....
131944	21066	Feed Bar Slide Block 131943 with 68495 and 134260 .....
131957	21066	Feed Driving Shaft and Feed Lifting Eccentric for 134312..... NOTE: When No. 131957 is required for repairs, the Arm Rotary Shaft must be returned to the factory to be adjusted to the new part.
131959	21066	Looper Driving Shaft and Feed Lifting Eccentric Bushing .....
131961	21038	Machine Base Oil Drain Jar (glass).....
131962	21038	Machine Base Oil Drain Jar Cap.....
134254	21064	Cloth Plate Supporting Post.....
134255	21064	Cloth Plate Supporting Post Spacing Collar .....
134256	21065	Face Plate (lower half) .....
134257	21065	Face Plate (lower half) Gasket (cork).....
134260	21066	Feed Bar Slide Block Oil Pad Retainer for 131944 .....
134260	21063	Feed Connecting Rod Oil Pad Retainer for 131500 .....
134261	21035	Feed Dog, 16 teeth (16 teeth to the inch) for 3/4 in. and 13/16 in. gauges.....
134262	21036	Feed Dog, 16 teeth (16 teeth to the inch) for 7/8 in. to 1 1/16 in. gauges, for 134301..

## NUMERICAL LIST OF PARTS

No.	Plate	Name
134263	21036	Feed Dog, 16 teeth (16 teeth to the inch) for 1 1/8 in. to 1 1/4 in. gauges, for 134302.....
134264	21037	Feed Dog, 16 teeth (16 teeth to the inch) for 1 5/16 in. to 1 1/2 in. gauges, for 134303.....
134266	21027	Looper Driver Connection with 134267, for 134392 .....
*134267	-----	Feed Driver Connection Oil Plug for 134266
134268	21027	Looper Holder (left) with 175AL, for 134308 and 134309 .....
134269	21027	Looper Holder (right) with 175AL, for 134308 and 134309 .....
134270	21027	Looper Holder Connection for 3/4 in. and 13/16 in. gauges..... NOTE: When No. 134270 is required for 9/16 in., 5/8 in. or 11/16 in. gauge, the part will be furnished in 3/4 in. gauge and the desired gauge can be obtained by using the loopers listed for gauge required.
134271	21027	Looper Holder Connection for 7/8 in. to 1 1/2 in. gauges..... NOTE: When ordering No. 134270 or 134271, state gauge required.
134272	21027	Looper Holder Connection Hinge Stud with 175AL .....
134273	21027	Looper Throw-out Crank for 134307 .....
134274	21027	Looper Throw-out Crank Compression Plate for 134275 .....
134275	-----	Looper Throw-out Crank Compression Plate 134274 with 26276 and 134276 .....
134276	21027	Looper Throw-out Crank Compression Plate Hinge Stud for 134275 .....
134277	21027	Looper Throw-out Crank Handle with two 462AL for 134307.....
134278	21027	Looper Throw-out Slide Block for 134307...
134279	21027	Looper Throw-out Slide Block Bracket (left) for 134307 .....
134280	21027	Looper Throw-out Slide Block Bracket (right) for 134307.....
134281	21027	Looper Throw-out Slide Block Bracket Gib (left) for 134307 .....
134282	21027	Looper Throw-out Slide Block Bracket Gib (right), for 134307.....
134283	21027	Looper Throw-out Slide Block Oil Pad for 134307 .....
134284	21027	Looper Throw-out Slide Block Oil Pad Retaining Pin for 134307.....
134286	21067	Needle Clamp with two 50379F, for 134361 .....
134287	21033	Needle Guard for 3/4 in. to 1 1/16 in. gauges.....
134288	21036	Needle Guard for 1 1/8 in. to 1 1/2 in. gauges .....
134289	21033	Needle Guard Holder.....

No.	Plate	Name
134290	21068	Oil Pipe (front of arm) with 131089, 134294 and two 1733, for oiling Looper Driving Shaft and Feed Lifting Eccentric Front Bearing for 134363.....
134291	21068	Oil Pipe (front of arm) with 68497 and 131003, for oiling Feed Bar for 134363...
134292	21068	Oil Pipe (front of arm) with 1733, 68497 and 131003, for oiling Arm Rotary Shaft Front Bearing for 134363.....
*134294	-----	Oil Pipe (front of arm) with 68497, for oiling Looper Throw-out Device, for 134290 .....
134295	21068	Oil Pipe (front of arm) Connection with two 198E, for 134362 .....
134298	-----	Presser Foot Shank with 440J and 1700J for 134323, 134336 and 134354.....
134300	21035	Throat Plate for 3/4 in. and 13/16 in. gauges for 134261.....
134301	21036	Throat Plate, for 7/8 in. to 1 1/16 in. gauges, for 134262.....
134302	21036	Throat Plate, for 1 1/8 in. to 1 1/4 in. gauges, for 134263.....
134303	21037	Throat Plate, for 1 5/16 in. to 1 1/2 in. gauges, for 134264.....
134304	21066	Throat Plate Holder with two 1036AL for 134318 .....
134305	21064	Cloth Plate Slide Spring (side) for 134331 ..
134307	-----	Looper Throw-out Slide Block 134278 with 134273, 134277, 134279, 134280, 134281, 134282, 134283, two 134284 and four 219J, for 134308 and 134309 .....
134308	-----	Looper Throw-out Slide Block 134307 with 1454C, 134268, 134269, 134270, 134310, 134392 and two each 1651E and 50464C, for 3/4 in. and 13/16 in. gauges.....
134309	-----	Looper Throw-out Slide Block 134307, with 1454C, 134268, 134269, 134271, 134310, 134392 and two each 1651E and 50464C, for 7/8 in. to 1 1/2 in. gauges .....
134310	21027	Looper Holder Connection Hinge Stud Cap Screw Washer for 134308 and 134309.....
134312	-----	Looper Driving Shaft and Feed Lifting Eccentric 131957 with 68479 for 134357 ..
134315	21066	Feed Bar Guide for 134390 .....
134316	21066	Feed Bar Position Plate for 134318.....
134318	-----	Throat Plate Holder 134304 with 181E and 134316 .....
134322	-----	Presser Foot Plate for 134323 .....
134323	21035	Presser Foot (hinged) complete, for 11/16 in. to 1 1/2 in. gauges, for 134261 to 134264, Nos. 18055, 134298 and 134322..
134329	21064	Cloth Plate Slide for 134331.....
134330	21064	Cloth Plate Slide Spring (back) for 134331..

No.	Plate	Name
134331	21064	Cloth Plate Slide complete, for 134359, Nos. 134329, 134330, two 134305 and six 665J.....
134333	21033	Feed Dog, 21 teeth (16 teeth to the inch) for 11/16 and 3/4 in. gauges, for 134343, for shirt centering on broadcloth and similar materials.....
	NOTE:	Feed Dog No. 134333 is regularly furnished with this machine unless otherwise stated on order.
134334	21033	Feed Dog, 21 teeth (16 teeth to the inch) for 7/8 in. and 1 in. gauges, for 134344, for shirt centering on broadcloth and similar materials.....
	NOTE:	Feed Dog No. 134334 is regularly furnished with this machine unless otherwise stated on order.
134335	-----	Presser Foot Plate for 134336.....
134336	21034	Presser Foot (hinged) complete, for 3/4 in. to 1 in. gauges, Nos. 18055, 134298 and 134335.....
134337	21033	Presser Foot Extension with two 62527 for 134340 .....
134338	-----	Presser Foot Plate for 134340.....
134339	-----	Presser Foot Shank with 316F and 1700J for 134340 .....
134340	21033	Presser Foot (hinged extension and hinged plate) complete, for 9/16 in. to 1 in. gauges, for obtaining a smooth finish on broadcloth and similar materials, for 134343 and 134344, Nos. 18055, 128734, 128864, 134337, 134338, 134339 and two each 1145J and 39443.....
134341	21034	Throat Plate (flat) for 11/16 in. and 3/4 in. gauges, for 134333.....
134342	21034	Throat Plate (flat) for 7/8 in. and 1 in. gauges, for 134334.....
134343	21033	Throat Plate (raised in front of needle holes to reduce feeding before material is stitched) for 11/16 and 3/4 in. gauges, for broadcloth and similar materials, for 134333.....
134344	21033	Throat Plate (raised in front of needle holes to reduce feeding before material is stitched) for 7/8 in. and 1 in. gauges, for broadcloth and similar materials, for 134334.....
134345	21035	Feed Dog, 21 teeth (16 teeth to the inch) for 9/16 in. to 11/16 in. gauges, for 134355..
134346	21035	Looper (right) for 9/16 in. gauge.....
134347	21035	Looper (left) for 9/16 in. gauge .....
134348	21035	Looper (right) for 5/8 in. gauge.....
134349	21035	Looper (left) for 5/8 in. gauge .....

No.	Plate	Name
134350	21035	Looper (right) for 11/16 in. gauge.....
134351	21035	Looper (left) for 11/16 in. gauge.....
134352	21035	Needle Guard for 9/16 in. to 11/16 in. gauges.....
134353	-----	Presser Foot Plate for 134354.....
134354	21035	Presser Foot (hinged) complete, for 9/16 in. to 11/16 in. gauges, for 134345, Nos. 18055, 134298 and 134353.....
134355	21035	Throat Plate, for 9/16 in. to 11/16 in. gauges, for 134345.....
*134356	-----	Arm, upper and lower (solid) with 51422J, 68483 and four 131022.....
134357	-----	Arm Rotary Shaft 131476 with 640E, 131502, 131929 and 134312.....
134358	21064	Cloth Plate with two 1198C, for 134359.....
134359	21064	Cloth Plate complete, Nos. 134331 and 134358.....
134360	21033	Looper (left or right) for 3/4 in. to 1 1/2 in. gauges.....
134361	-----	Needle Bar complete, Nos. 131497 and 134286.....
134362	21068	Oil Pipe (front of arm) with 68497 and 134295, for oiling Feed Connecting Rod for 134363.....
134363	-----	Oil Pipe (front of arm) complete, Nos. 134290, 134291, 134292 and 134362.....
134389	21066	Feed Bar for 134390.....
134390	-----	Feed Bar complete, for 134391.....
134391	-----	Feed Rocking Frame 131240 with 59343, 131197 and 134390.....
134392	-----	Looper Driver Connection 134266 with 134272, for 134308.....
135115	-----	Bench Stand with 27998, 60220 and four each 126849 and wood screws 1 1/2 in. No. 10 F.H., for use with Machine Base 131671..
138306	-----	Feed Eccentric Lubricating Pad (wood) for 54025.....
139017	21065	Arm Hole Plug Screw Washer.....
140219C	21032	Rock Shaft Stop Dog Set Screw for 2770.....
150058	24513	Thread Unwinder Thread Separator for 150061.....
150060	24513	Thread Unwinder Thread Separator Bracket Arm with 164J and 9525 for 150061.....
150061	-----	Thread Unwinder Thread Separator complete, Nos. 164J, 9525, 150058 and 150060.....
150062	24513	Thread Unwinder complete, for four spools, Nos. 150061, 228767, 228768, 228772, 228774, two 228766, three wood screws 7/8 in. No. 12 F.H. and four each 150203, 228764 and 228769.....
150203	24513	Thread Unwinder Spool Rest Cushion (felt) for 150062.....
150451	21032	Treadle Stand for 150452.....

No.	Plate	Name
150452	21032	Treadle complete, Nos. 4879, 4882, 126249, 126250, 150451 and two wood screws 1 in. No. 16 F.H.....
201254C	24513	Thread Unwinder Spool Rest Set Screw for 228766.....
225390	24513	Thread Unwinder Thread Cone Holder, for inverted cones, for 150062.....
228764	24513	Thread Unwinder Spool Pin for 150062.....
228766	24513	Thread Unwinder Spool Rest (for two spools) with 201254C for 150062.....
228767	24513	Thread Unwinder Spool Rest Rod for 150062.
228768	24513	Thread Unwinder Spool Stand for 150062....
228769	24513	Thread Unwinder Thread Guide for 228769..
228772	24513	Thread Unwinder Thread Guide Holder for 150062.....
228774	24513	Thread Unwinder Thread Guide Rod for 150062.....





21031 - 1/3

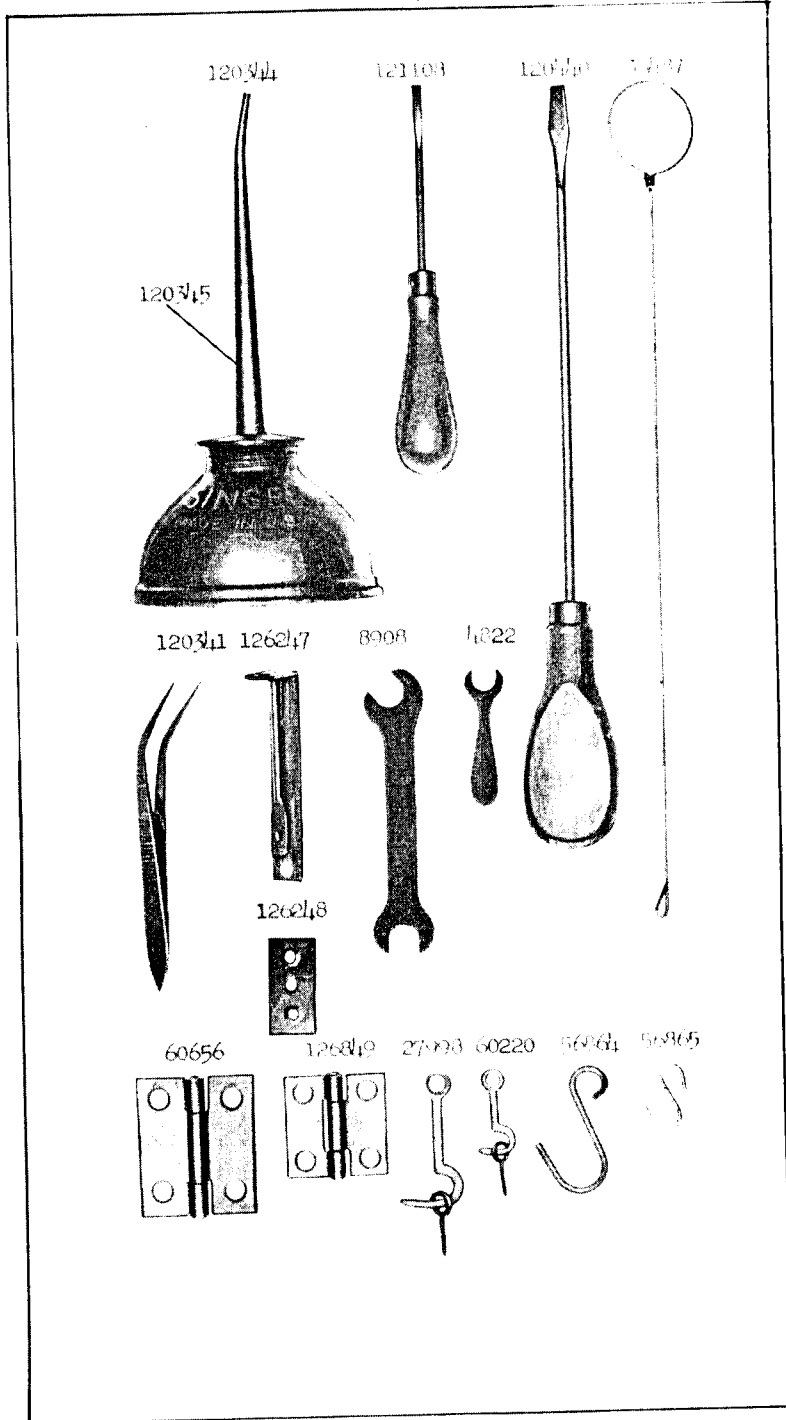

21032 - 1/4

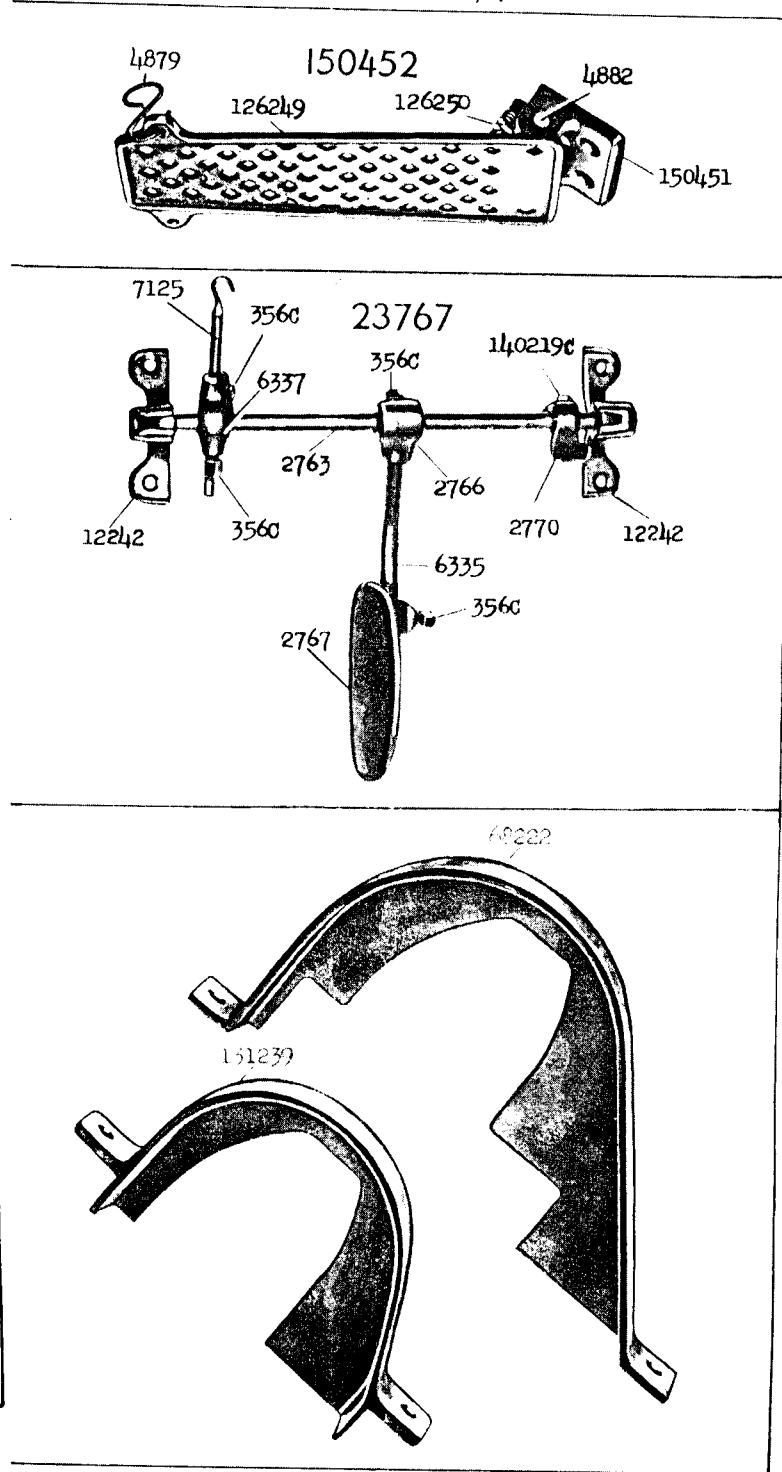

21033 - 1/2

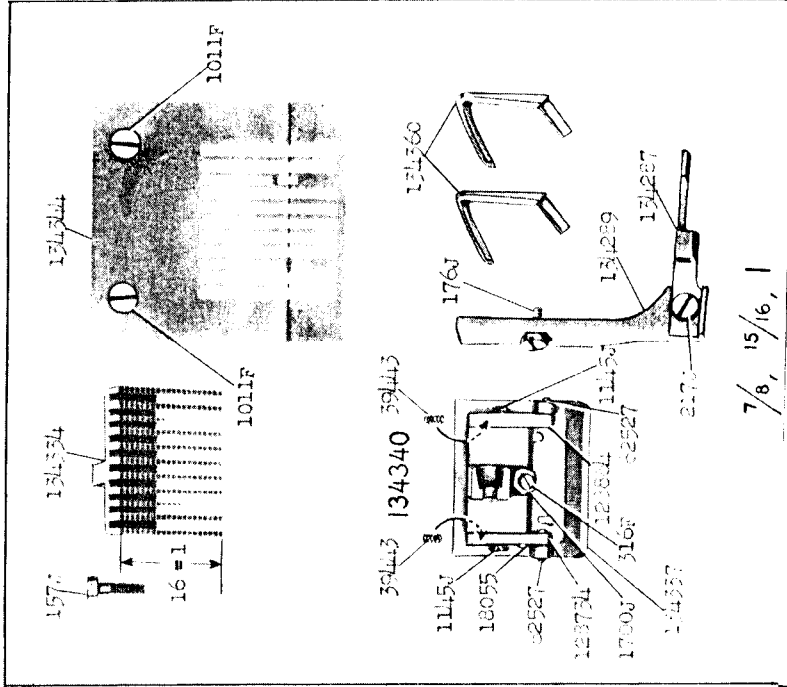

7/8, 15/16, 1

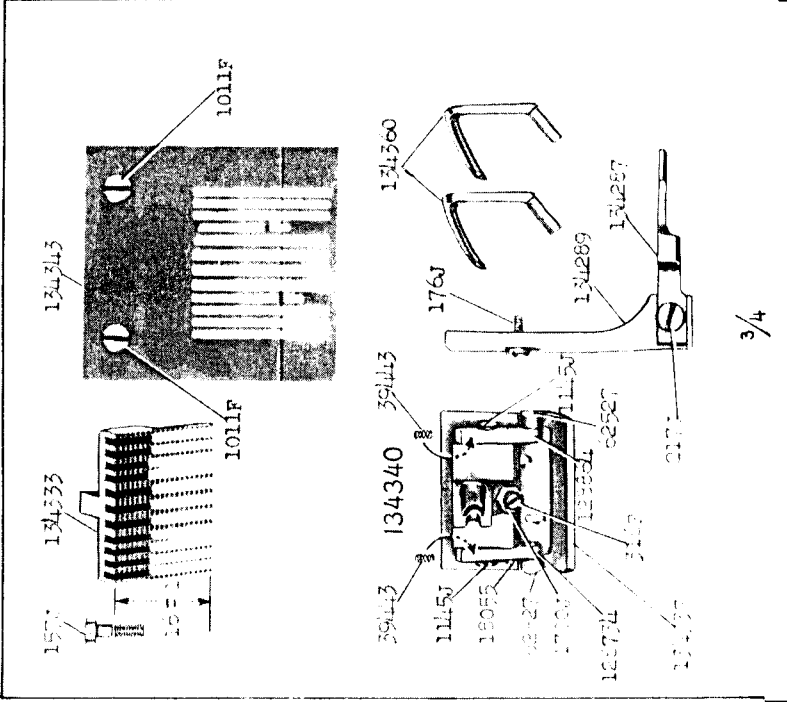

3/4

21034 - 1/2

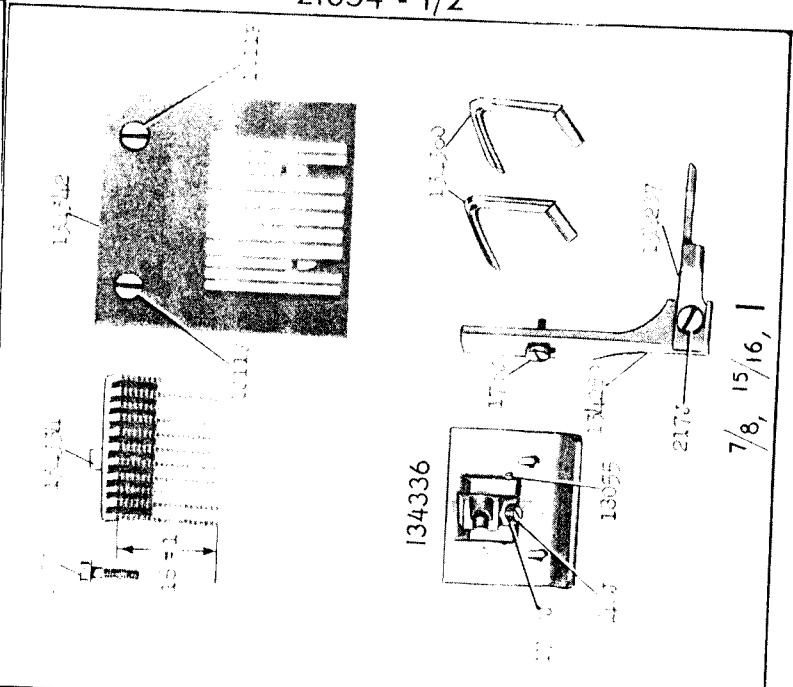

7/8, 15/16, 1

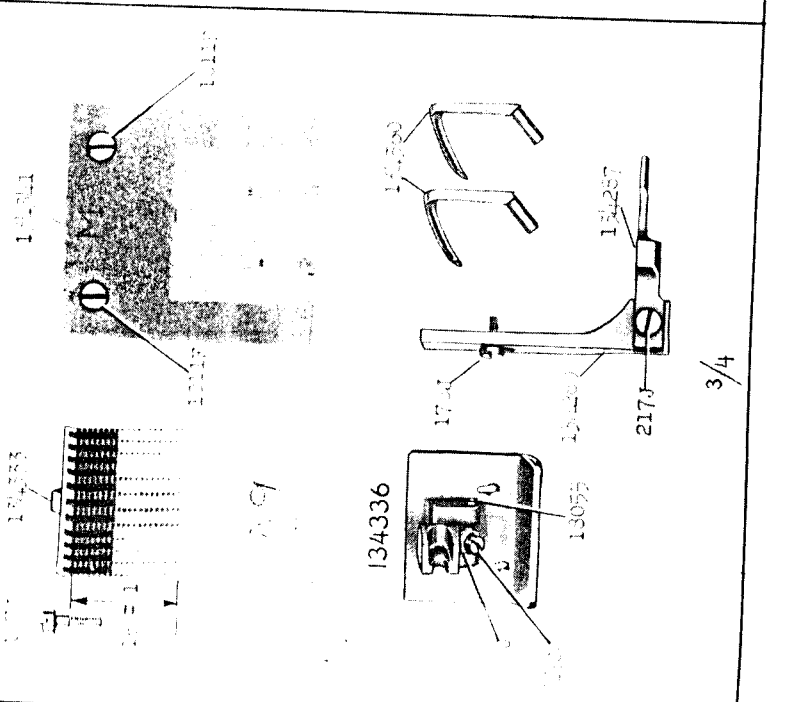

3/4

21035 - 1/2

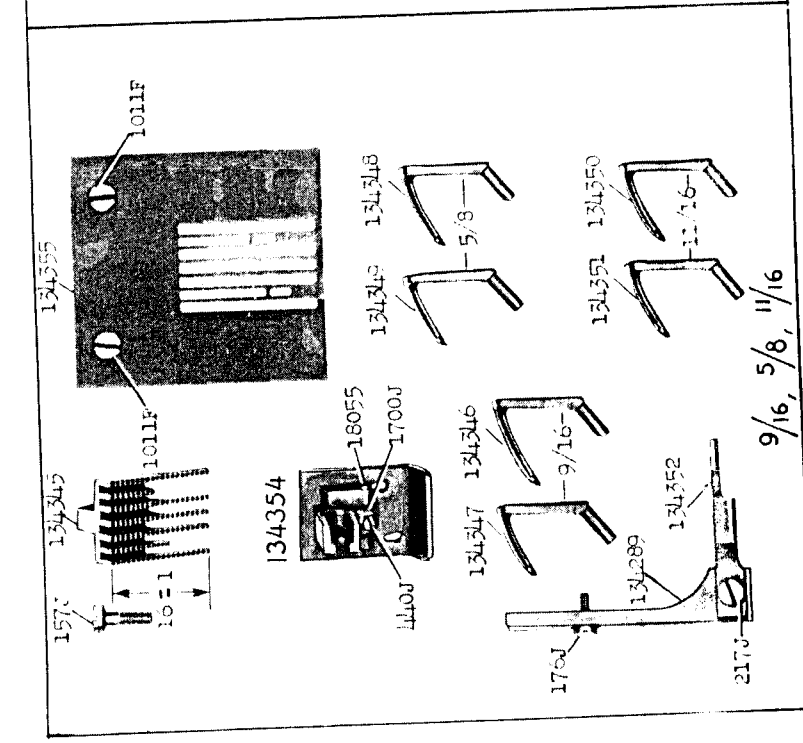
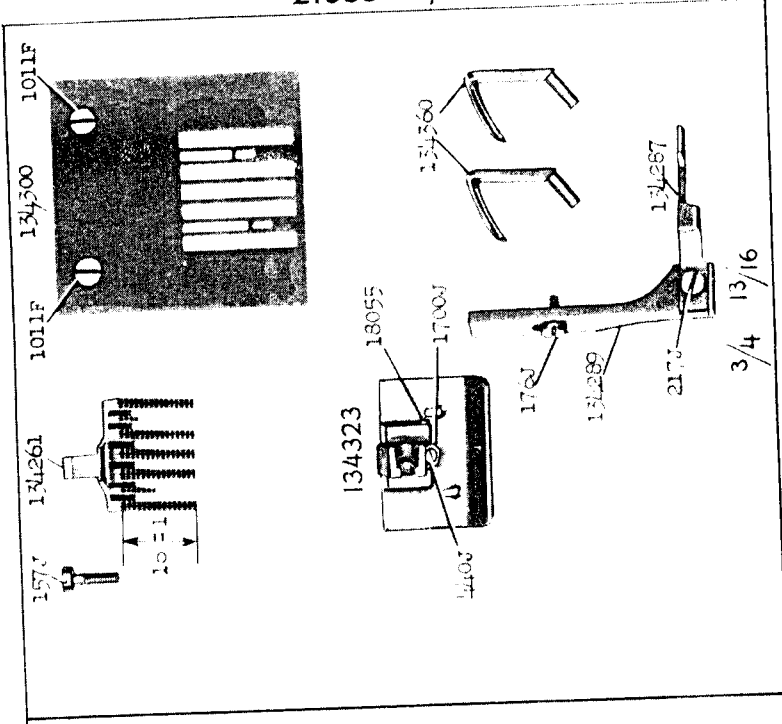

21036 - 1/2

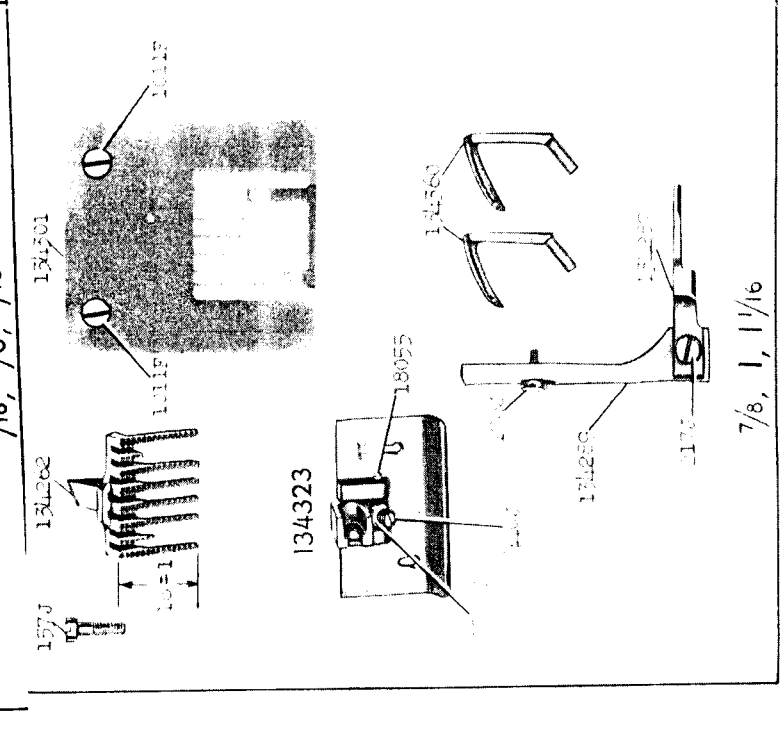
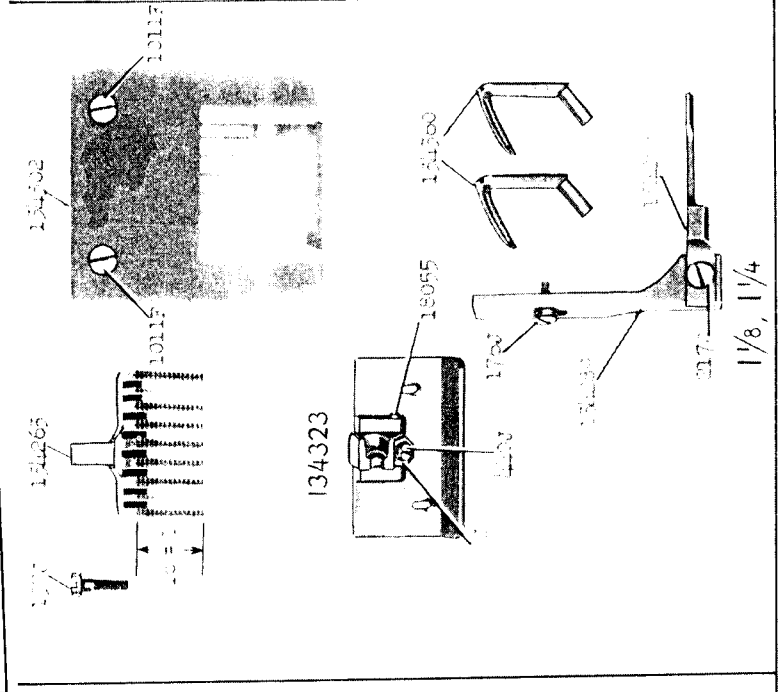

21037 - 1/2

21038 - 1/4

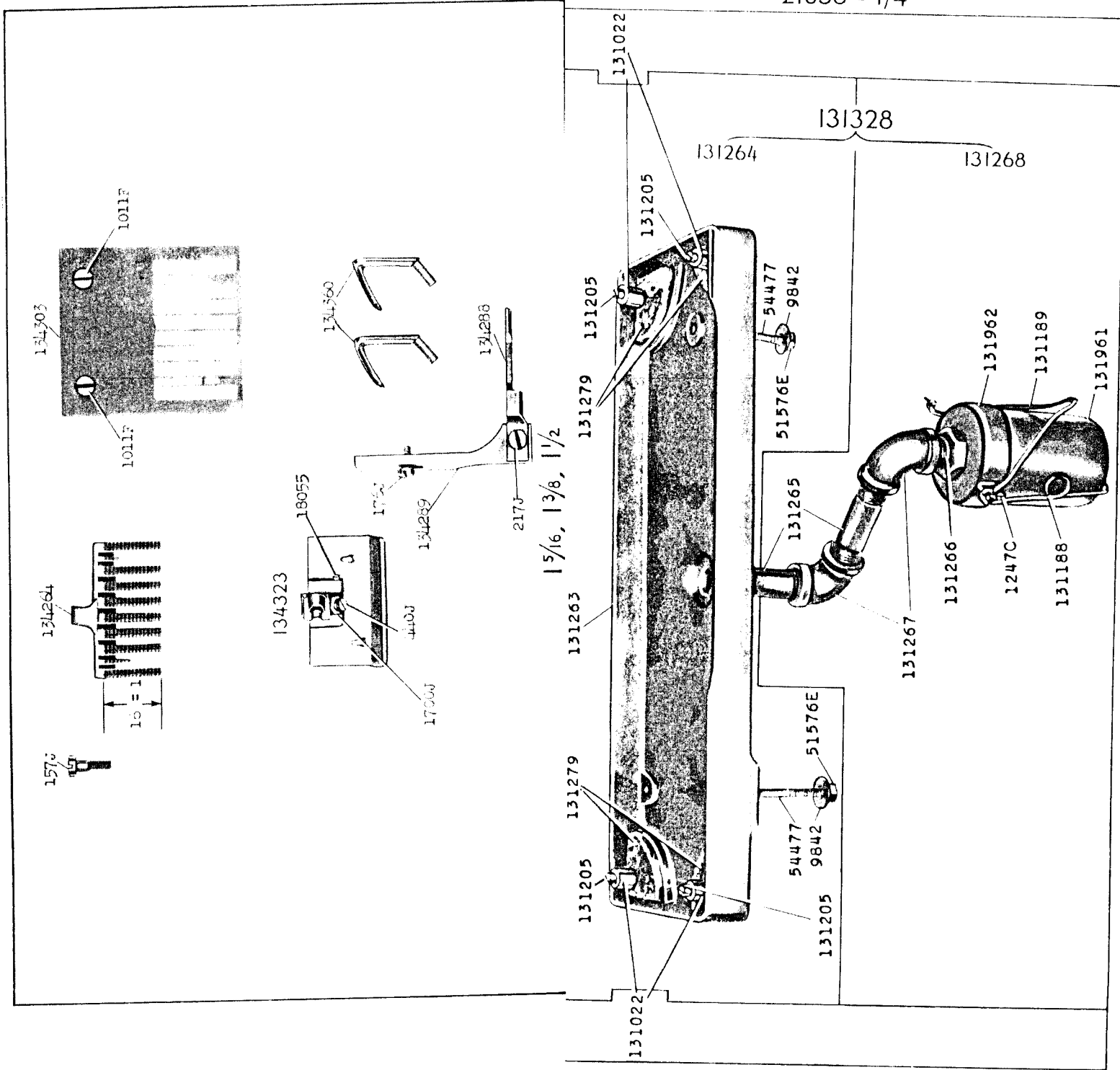

21040 - 1/4

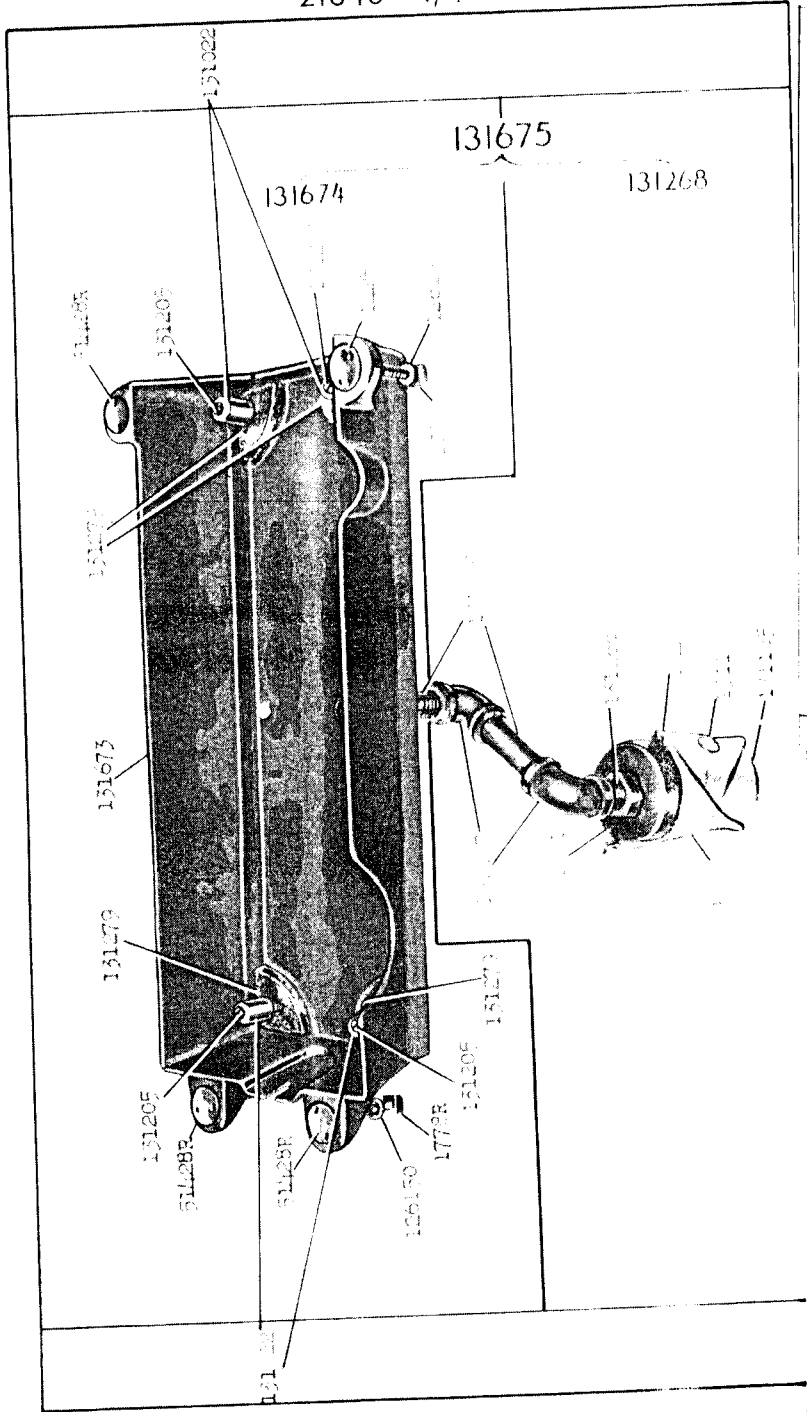

21042 - 1/3

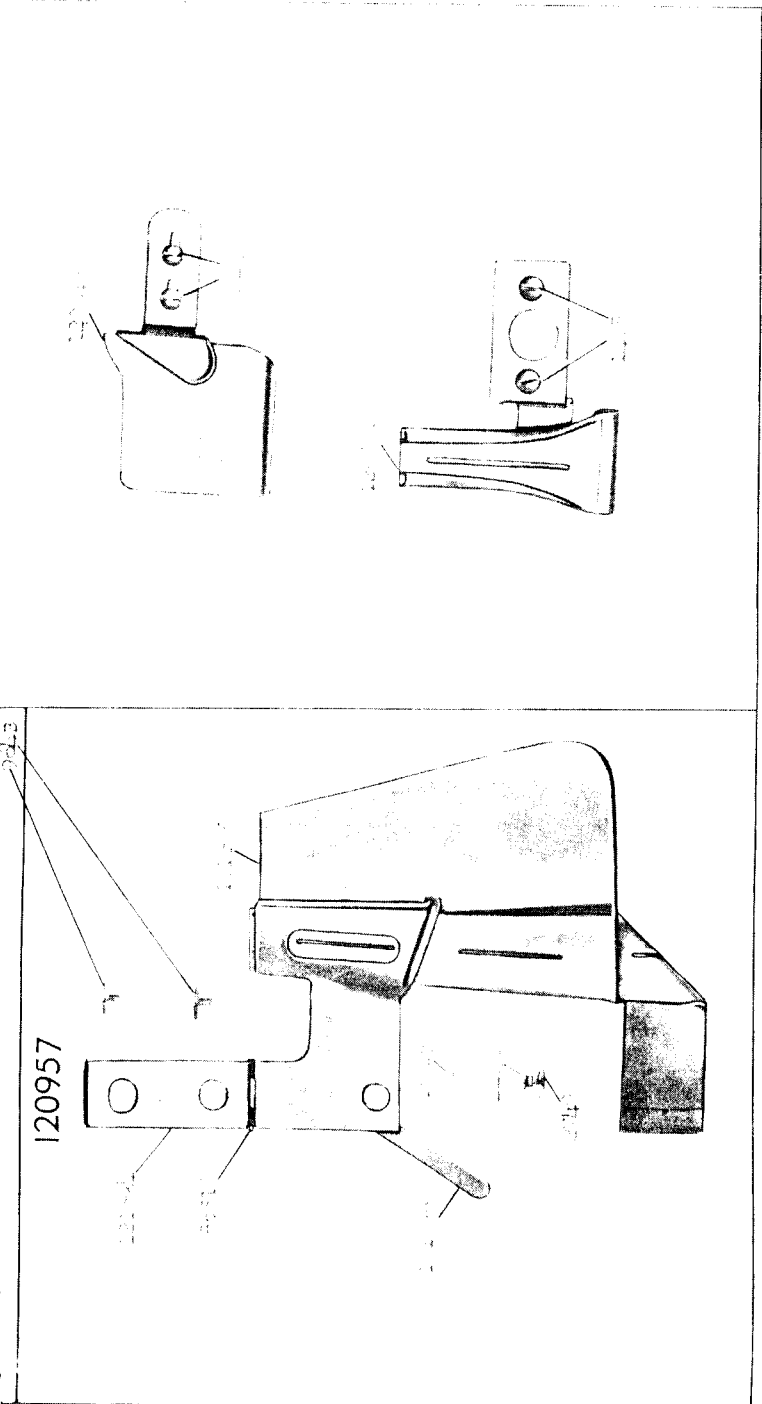



21064-1/4

21065-1/2

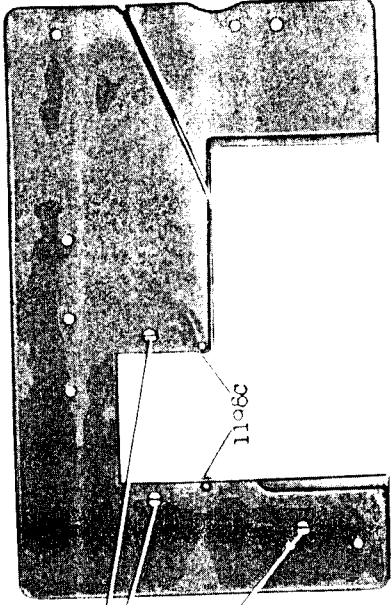

134358

134359

134331

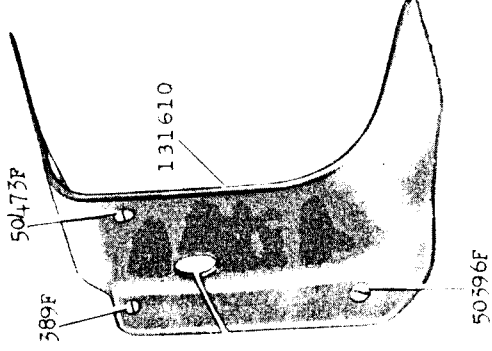

1011F

134254

2620R

134255

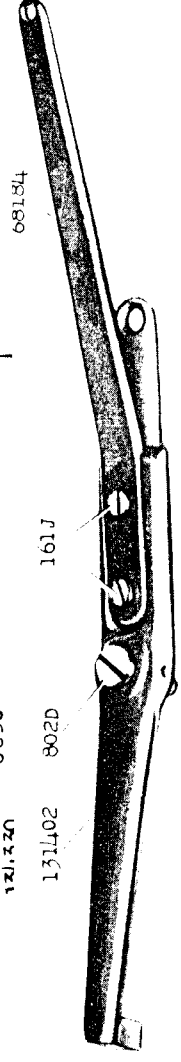
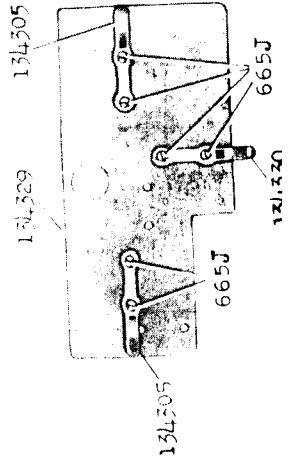

131395

51224W

1053E

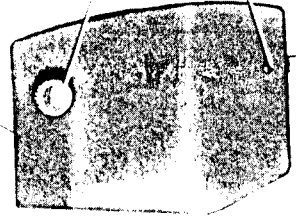

131830

131750

51697W

131749

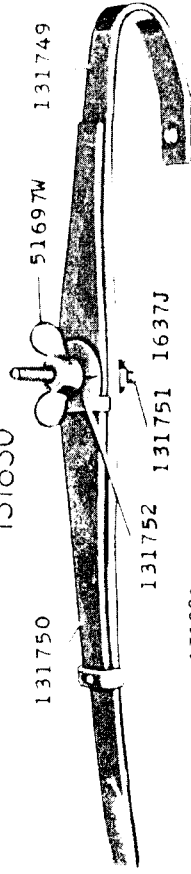

131752

131751

1637J

38468

29234

134257

134256

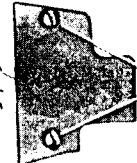

330D

68448

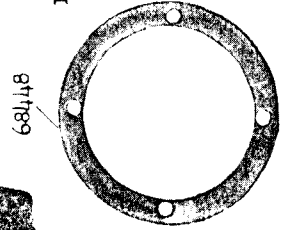

1289X

131910

131909

50608R

139017

1057K

1057K

131276

1057K

68429

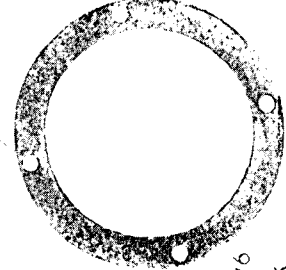

68426

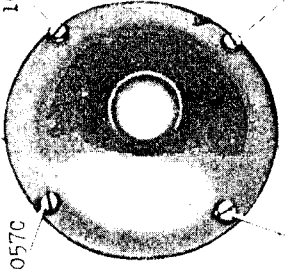

1057C

1057C

1057C

21066-1/2

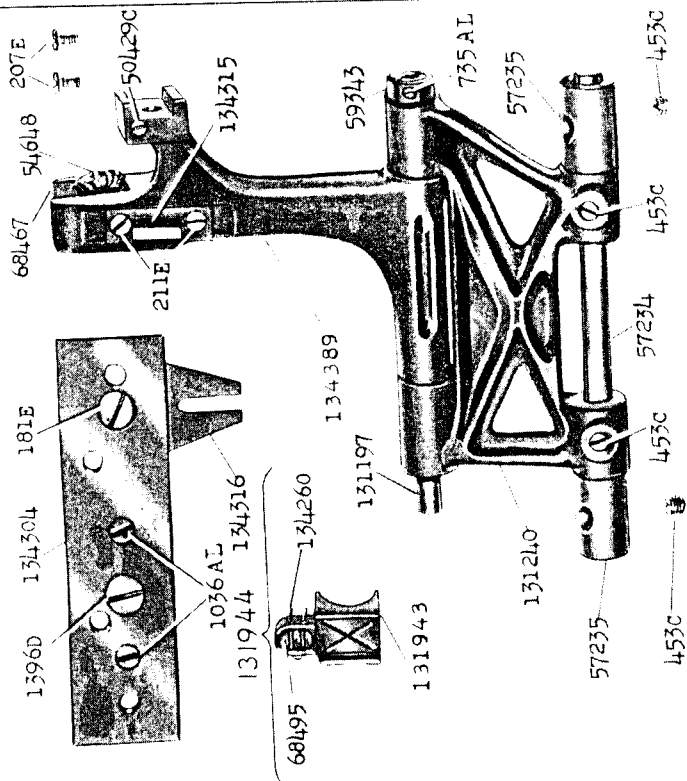
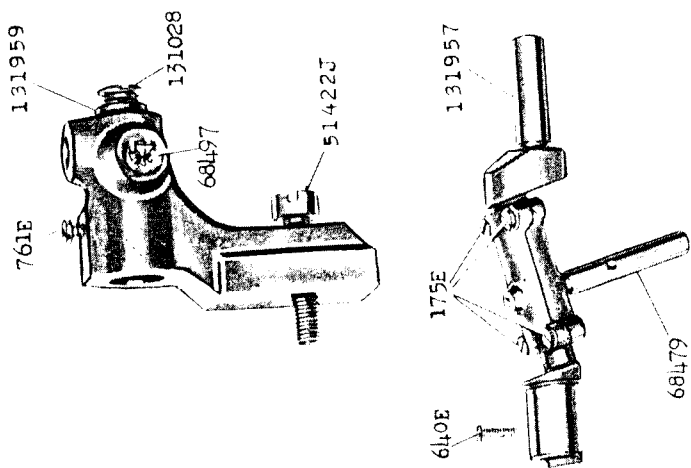

21067-2/3

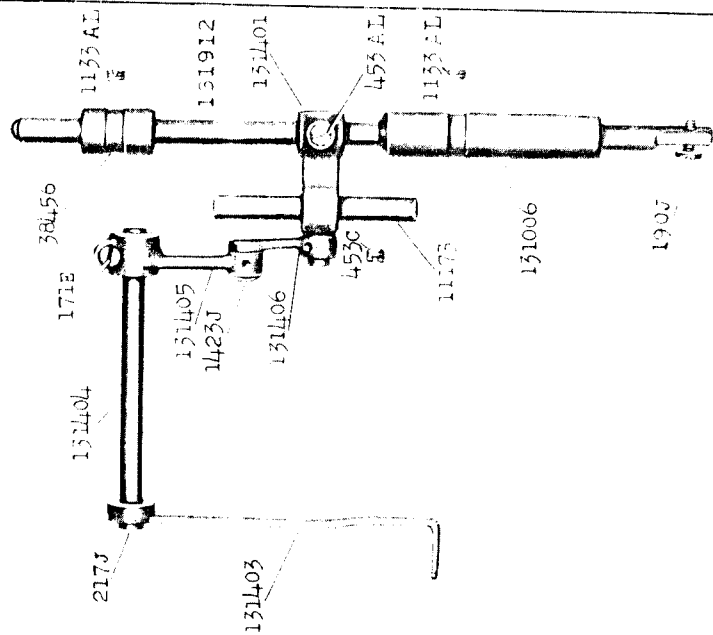
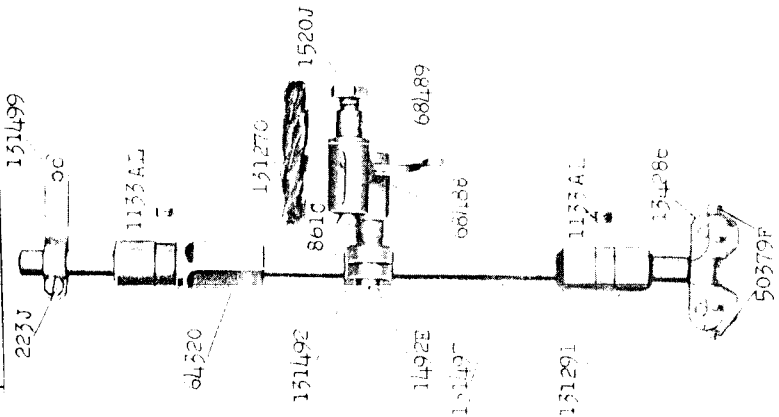





21070 1/4

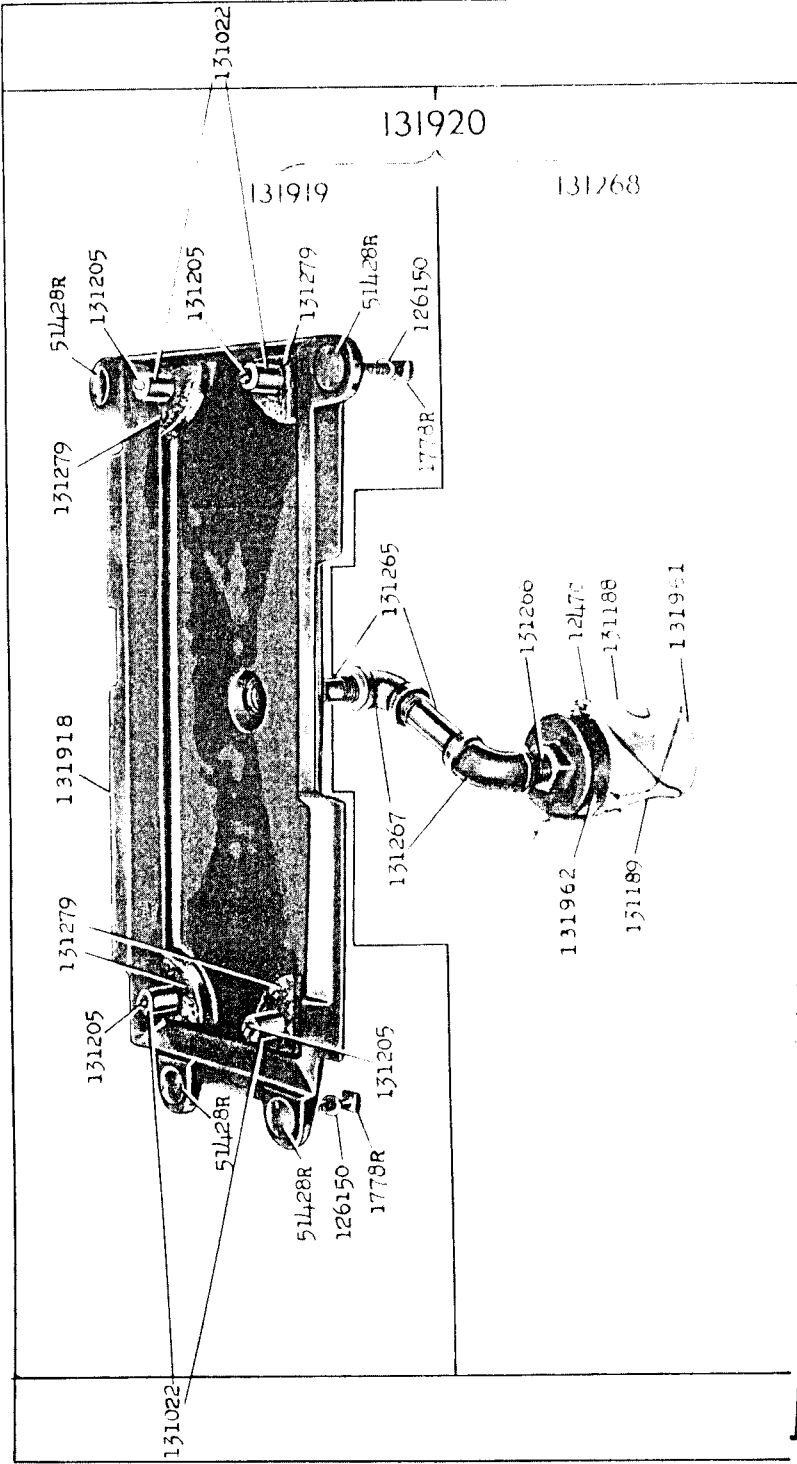

21071 1/3

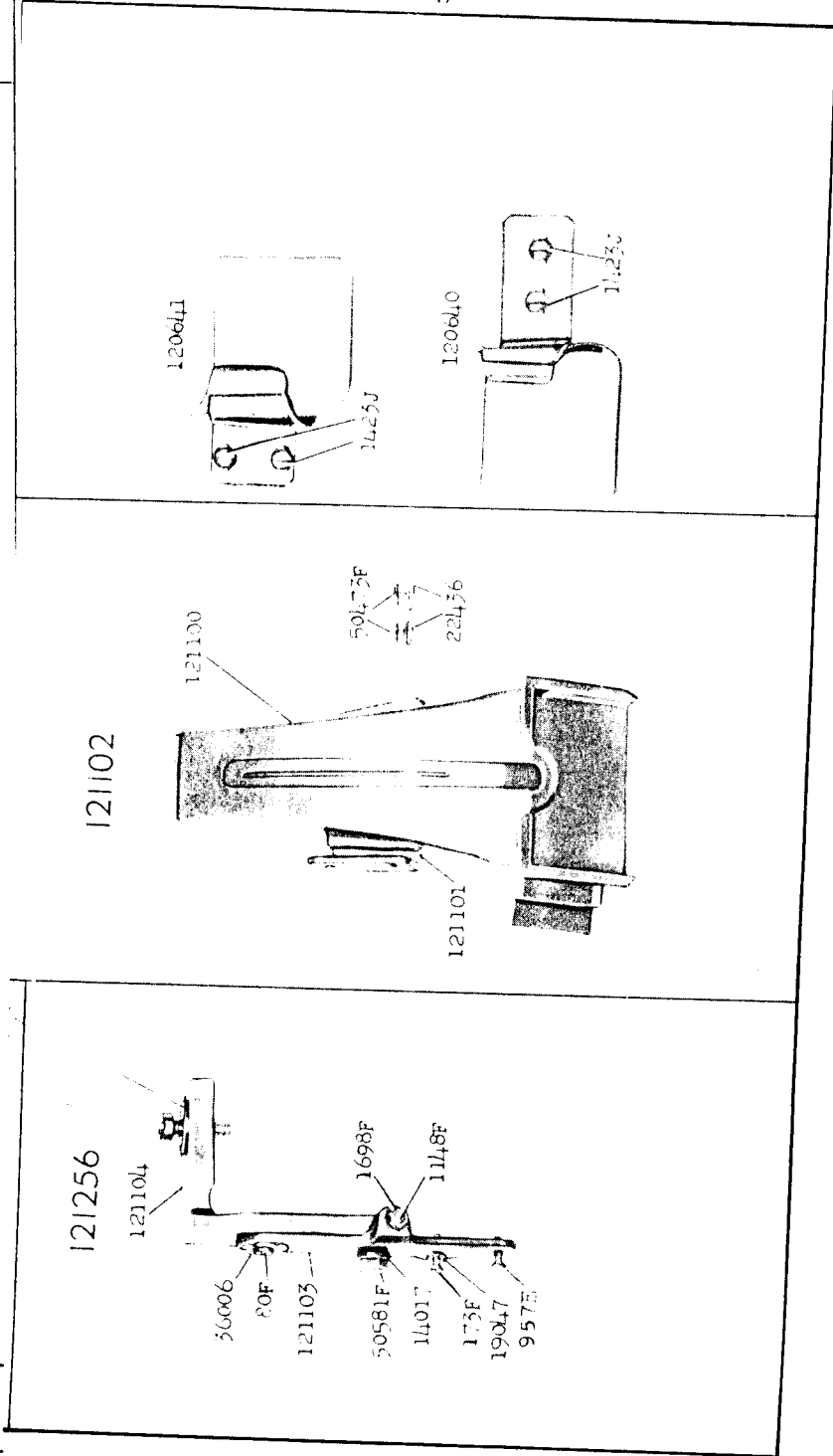

24513-1/6

150062

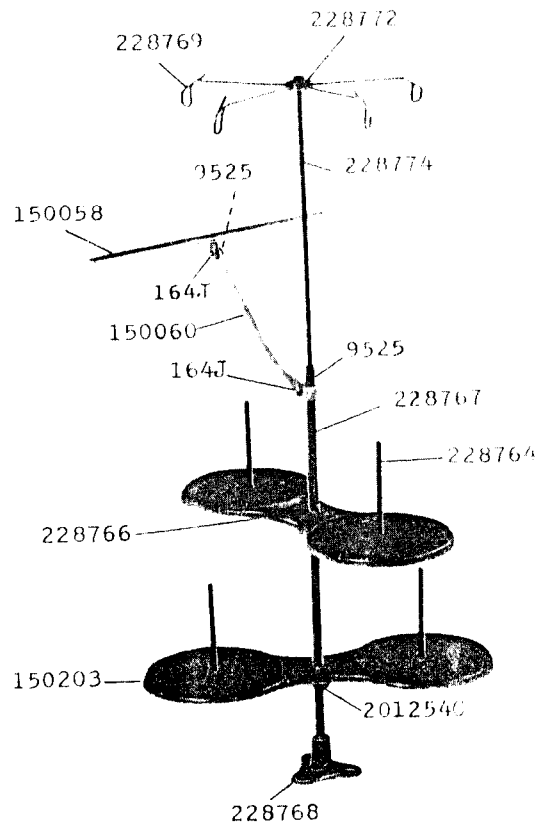

27739



225390

