

SINGER
153B8

INDEX

	Page
Thread take up lever, needle bar for all models	1
天秤・針棒関係	
Arm shaft, feeding mechanism for 153B8	2
上軸・送り機構関係	
Lifting lever, face plate, slide plate	3
弓、面板、差し板、ベース関係	
Presser bar, lifting rock shaft, vibrating presser foot for 153B8	4
押え棒・横軸・中押え関係	
Hook driving shaft, rotating hook, timing belt for all models	5
下軸、カム関係	
Thread tension, feed driving rock shaft, feeder, needle plate	6
糸掛、糸調子、送り竿関係	
Accessories	7
附属関係	
Reverse stitch mechanism for 153B8B	8
Special parts for 153B1	12
153B1専用部品	
Belt guard	13
ベルトガード	

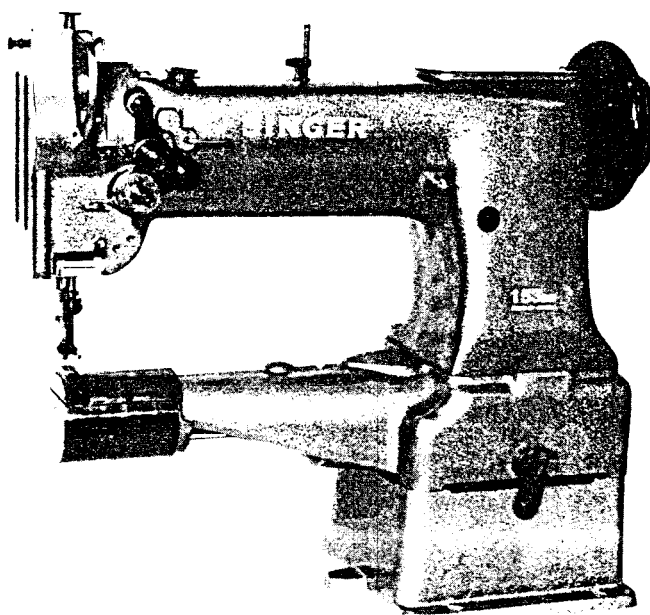

153B8

天秤・針棒関係

THREAD TAKE UP LEVER, NEEDLE BAR, ETC.

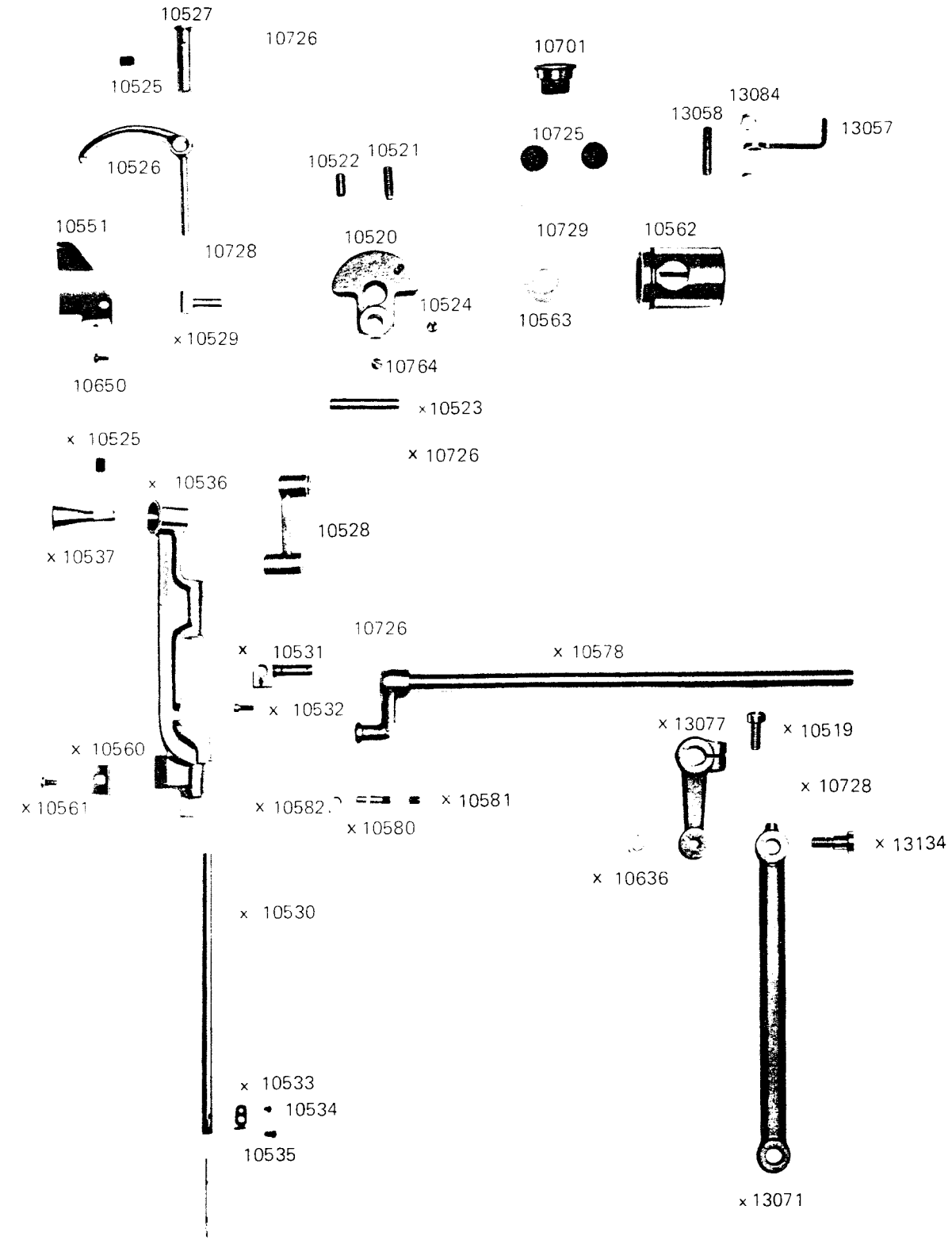

Cat. No. 3355

NOTE! WHEN ORDERING PARTS
PREFIX ALL NUMBERS BY
CS, EXAMPLE CS_

Parts marked X are not necessary for 153B1

×印は 必要

ARM SHAFT, FEEDING MECHANISM
FOR 153B8

2

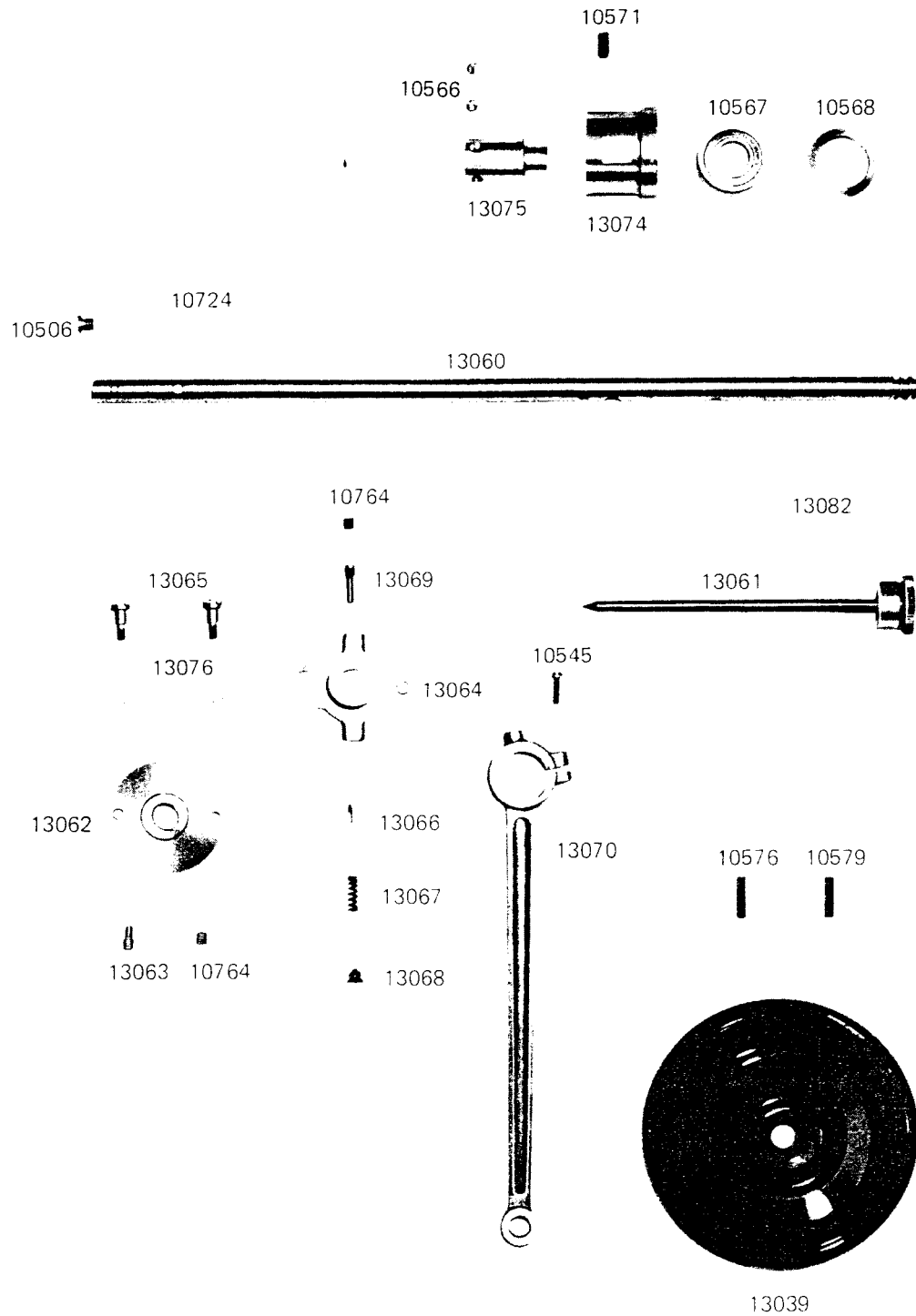

NOTE! WHEN ORDERING PARTS PREFIX ALL NUMBERS BY CS, EXAMPLE CS_

3

弓、面板、差し板、ベース関係 LIFTING LEVER, FACE PLATE, SLIDE PLATE

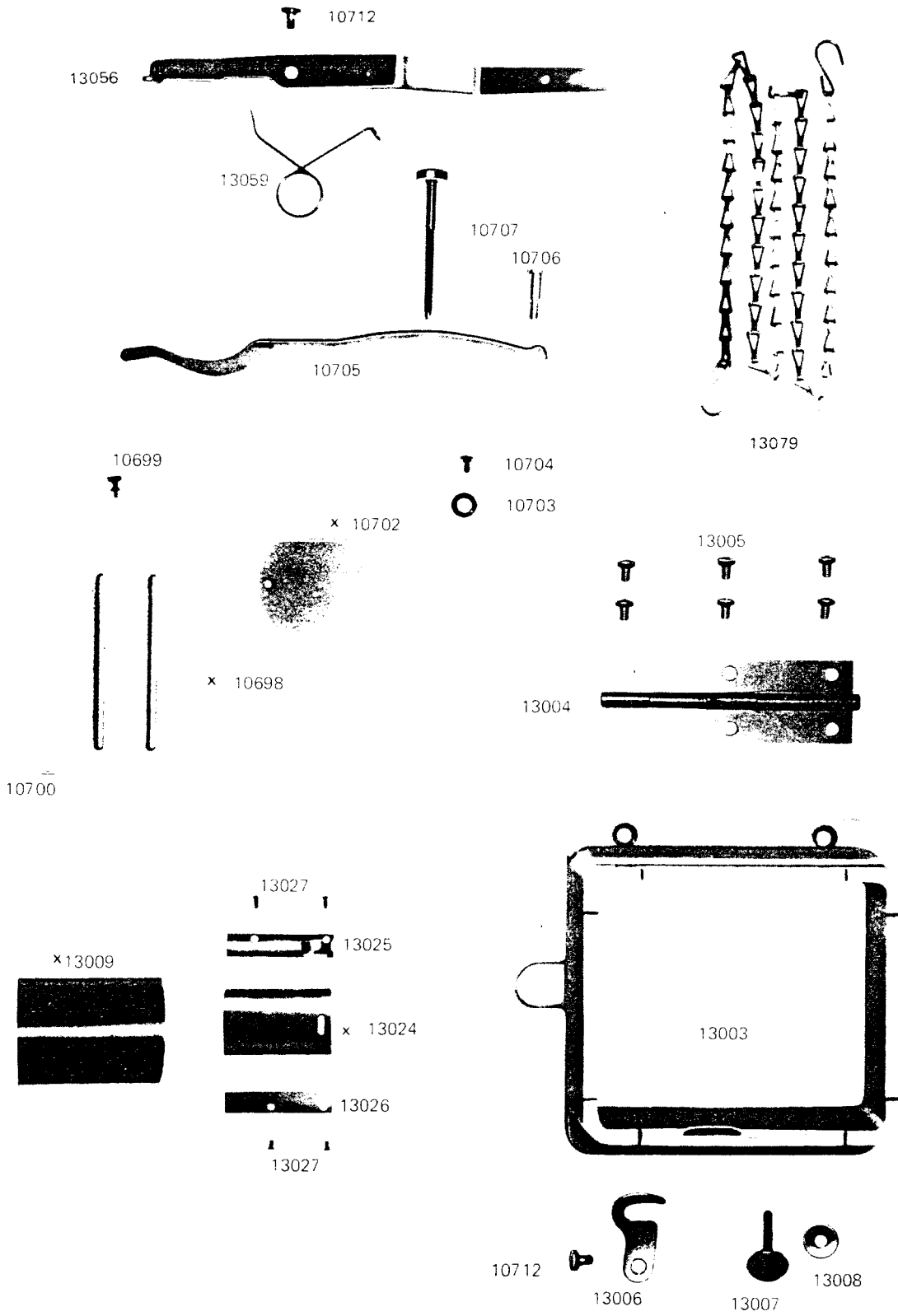

NOTE! WHEN ORDERING PARTS PREFIX ALL NUMBERS BY CS, EXAMPLE CS_

Parts marked X are not necessary for 153B1

*印は 必要

PRESSER BAR, LIFTING ROCK SHAFT, VIBRATING PRESSER FOR 153B8

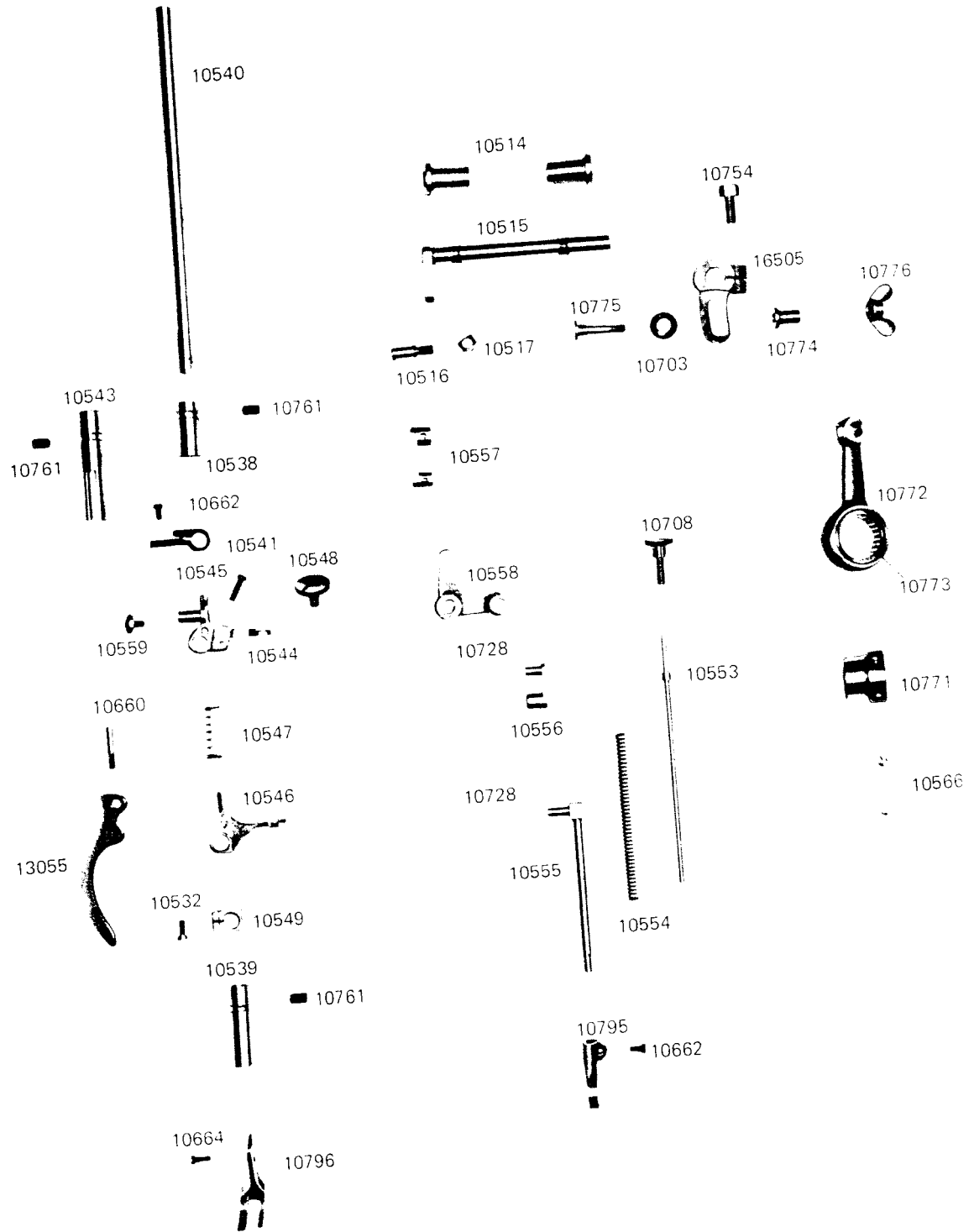

NOTE! WHEN ORDERING PARTS PREFIX ALL NUMBERS BY CS, EXAMPLE CS—

HOOK DRIVING SHAFT, ROTATING HOOK, TIMING BELT

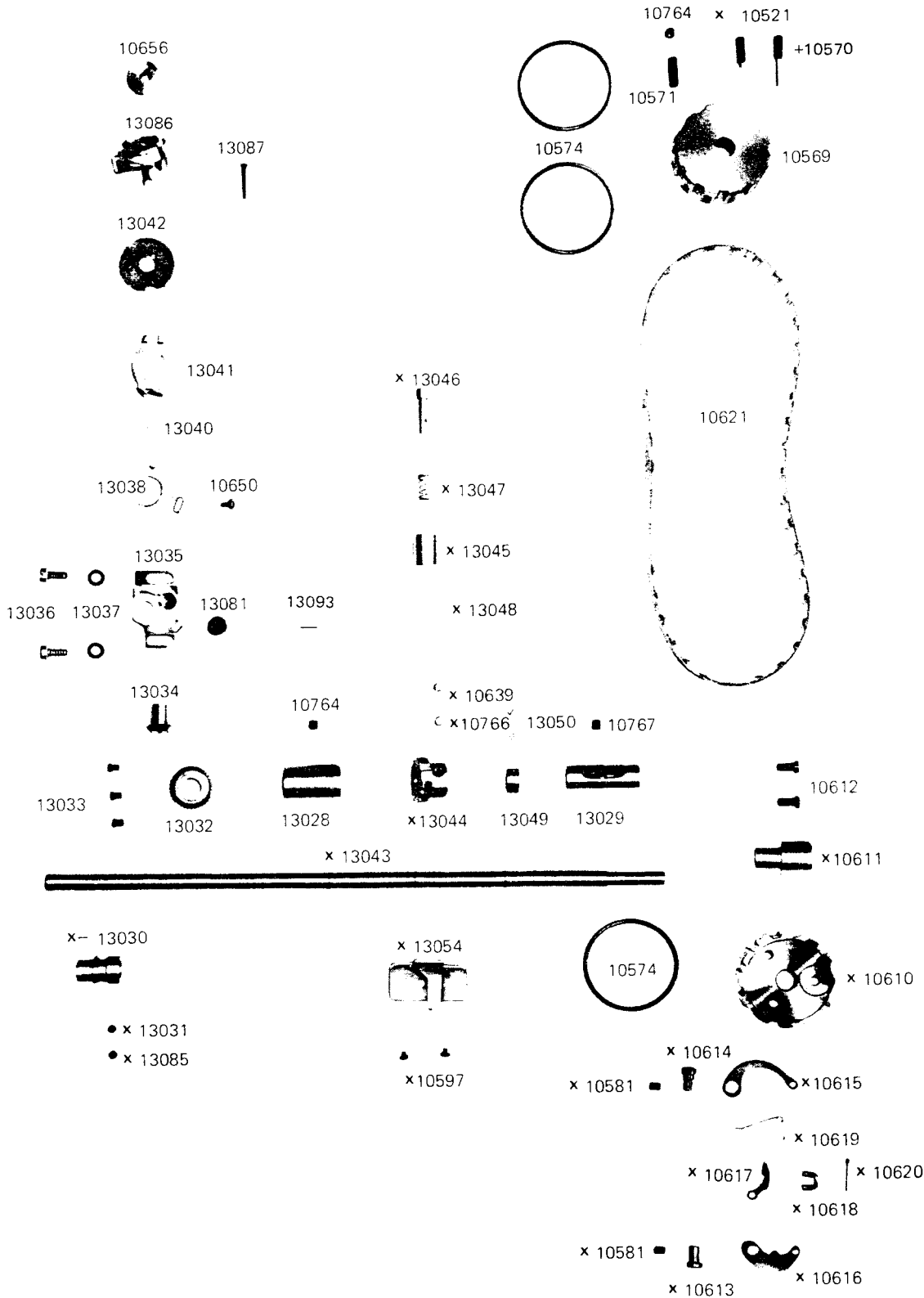

NOTE! WHEN ORDERING PARTS PREFIX ALL NUMBERS BY CS, EXAMPLE CS__

Parts marked X are not necessary for 153B1

Parts marked + is for only 153B8B

×印は153B1には不要

糸掛、糸調子、送り竿関係

THREAD TENSION, FEED DRIVING ROCK SHAFT, FEEDER,
NEEDLE PLATE

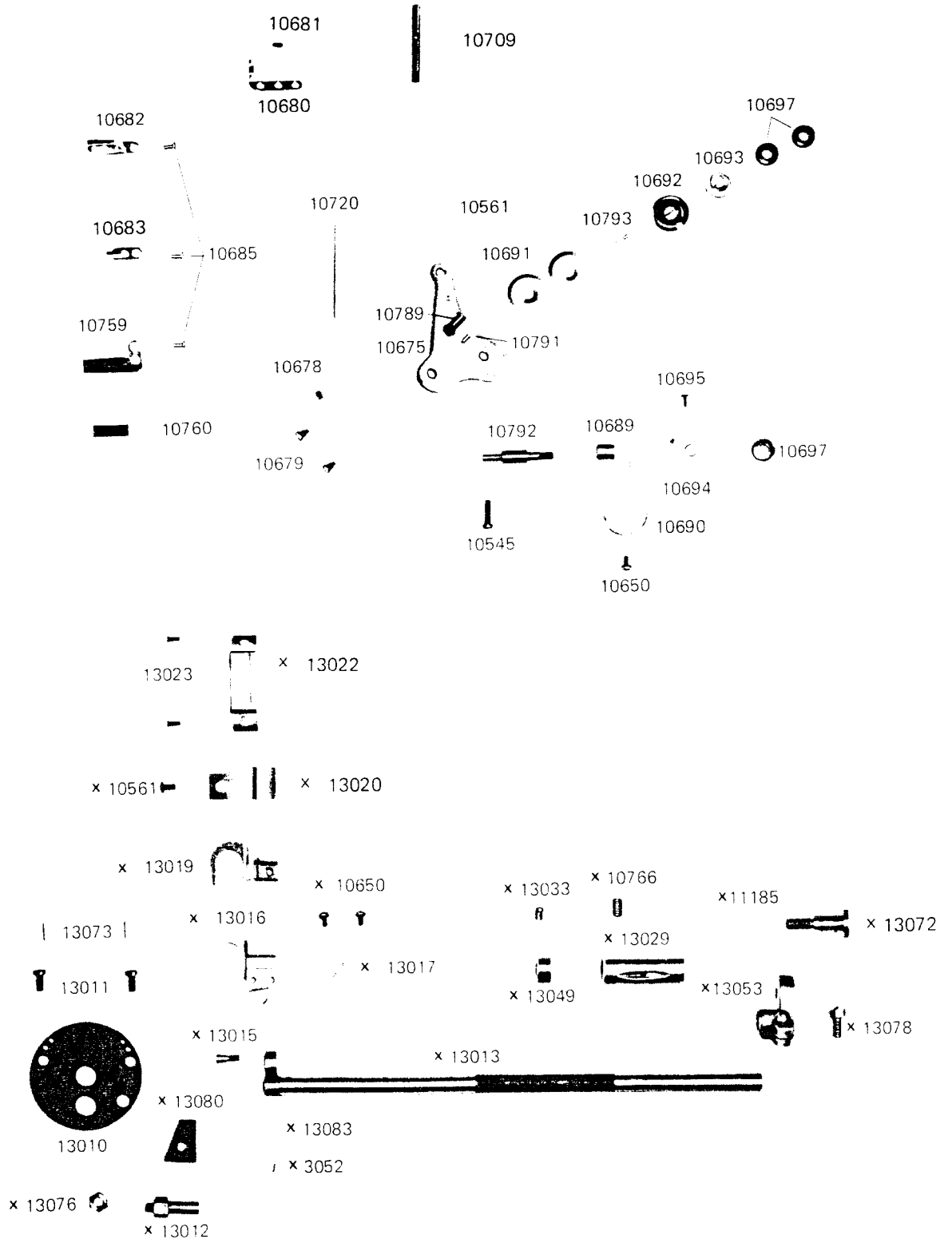

NOTE! WHEN ORDERING PARTS PREFIX ALL NUMBERS BY CS, EXAMPLE CS ____

Parts marked X are not necessary for 153B1

附属関係
ACCESSORIES

BELT GUARD (OPTIONAL) 13425C FOR 153B1, 13088C FOR 153B8



8132

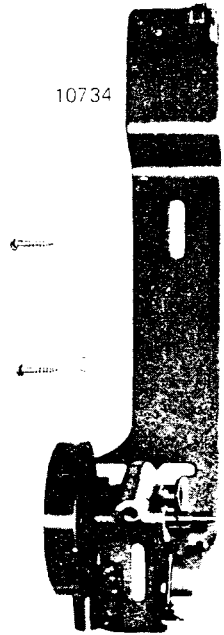

10734

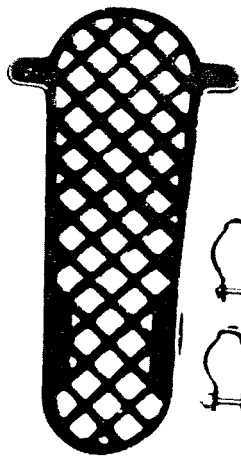

13094

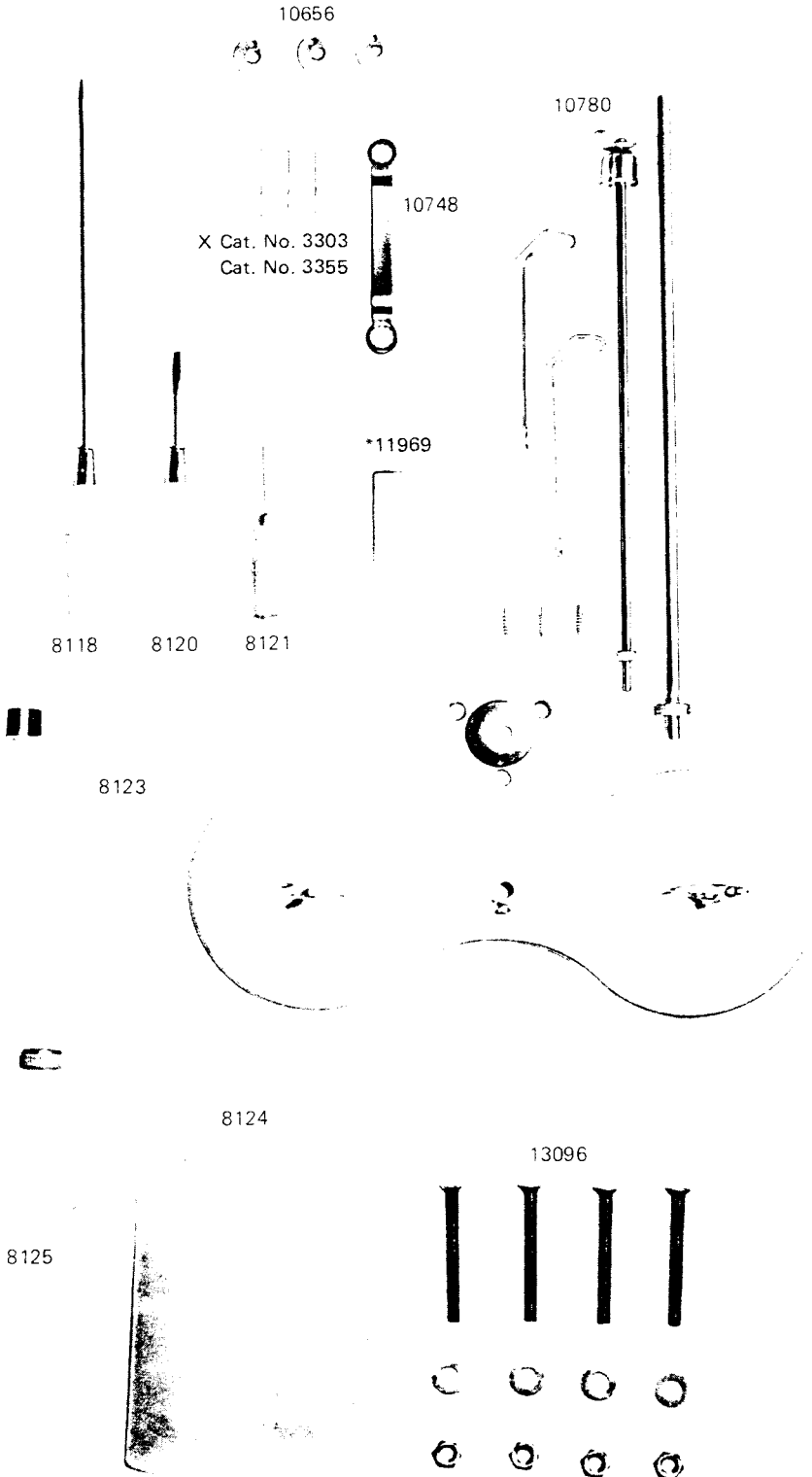

10656



X Cat. No. 3303
Cat. No. 3355

10748

10780

*11969

8118

8120

8121

8123

8124

8125

13096

Part marked * is used for only 153B8
Parts marked X is used for only 153B1

*Eは153B1のみ

NOTE! WHEN ORDERING PARTS PREFIX ALL NUMBERS BY CS, EXAMPLE CS_

1 専用部品
SPECIAL PARTS FOR 153B1

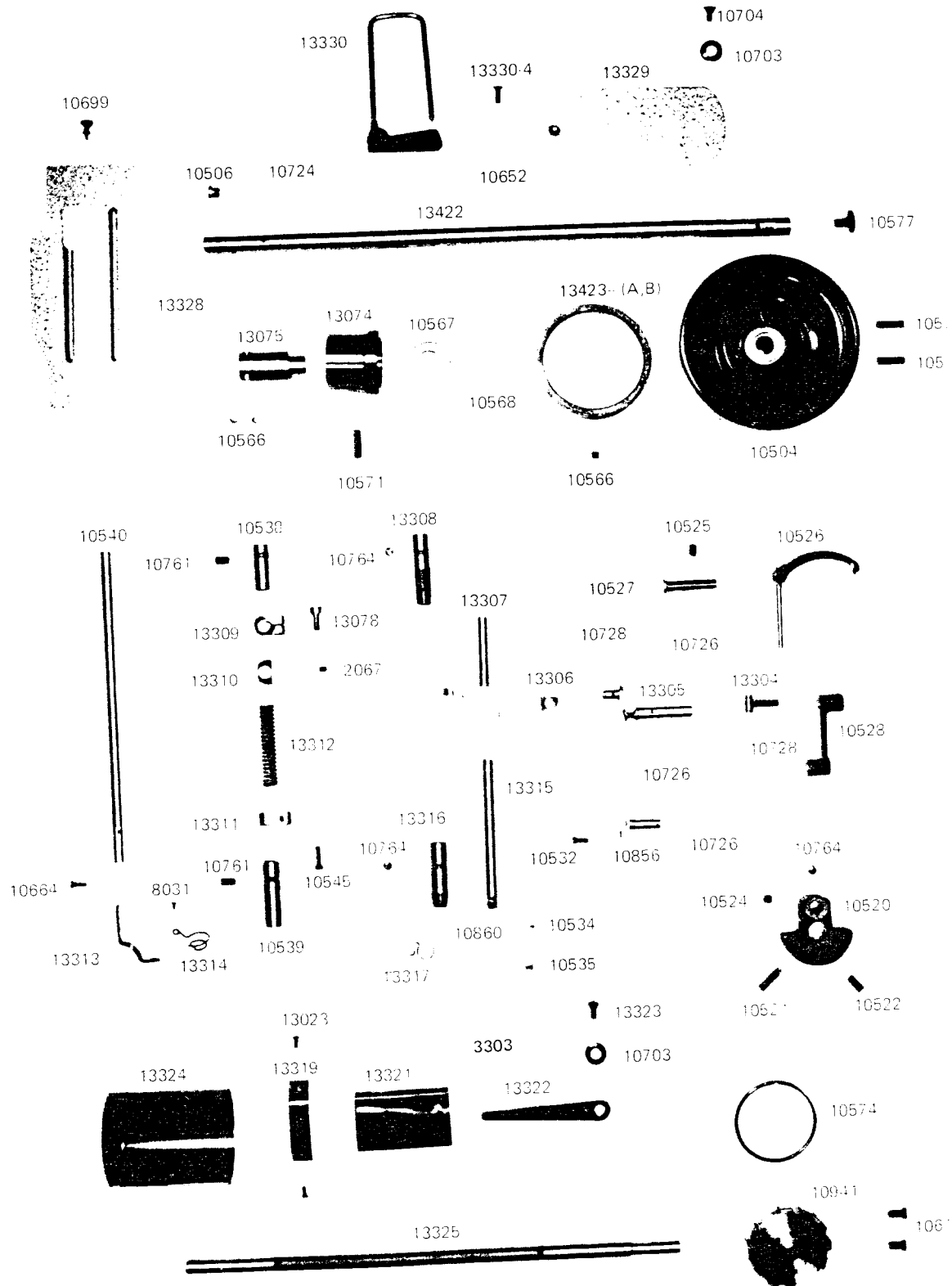

A ... Use with guard
NOTE) 13423 B ... Use without guard
NOTE! WHEN ORDERING PARTS PREFIX ALL NUMBERS BY CS, EXAMPLE CS—



A 有ガード用
B 無ガード用

ベルトガード
BELT GUARD

BELT GUARD COMPLETE
13425C FOR 153B1
13088C FOR 153B8

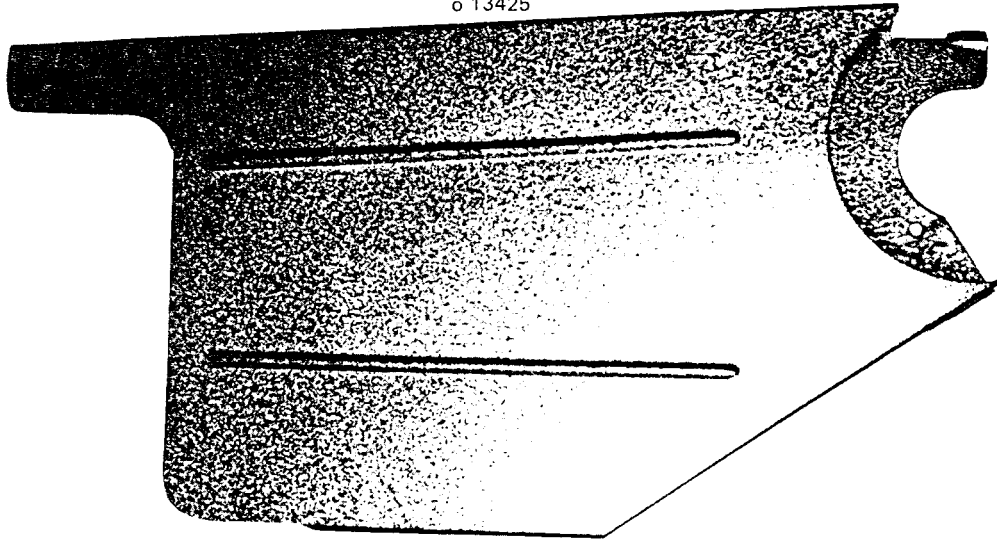

* 13132
o 13425





-  o 10559
-  o 11162

 
6339

-  o 50103
-  o 50099
-  o 14024

-  o 13427
-  * 11142

- * 13133
- o 13426

-  * 10561
- 

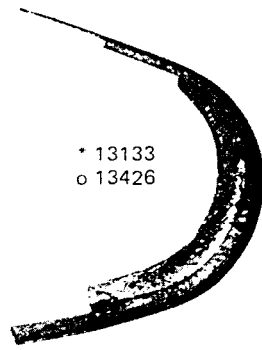

NOTE! WHEN ORDERING PARTS PREFIX ALL NUMBERS BY CS, EXAMPLE CS_____

Parts marked o are for 153B1 only
Parts marked * are for 153B8 only