

SINGER
15K88,K91

ILLUSTRATED
LIST OF PARTS

FOR

Nos. 15K88 to 15K91
MACHINES



**A Trade Mark of THE SINGER MANUFACTURING CO.

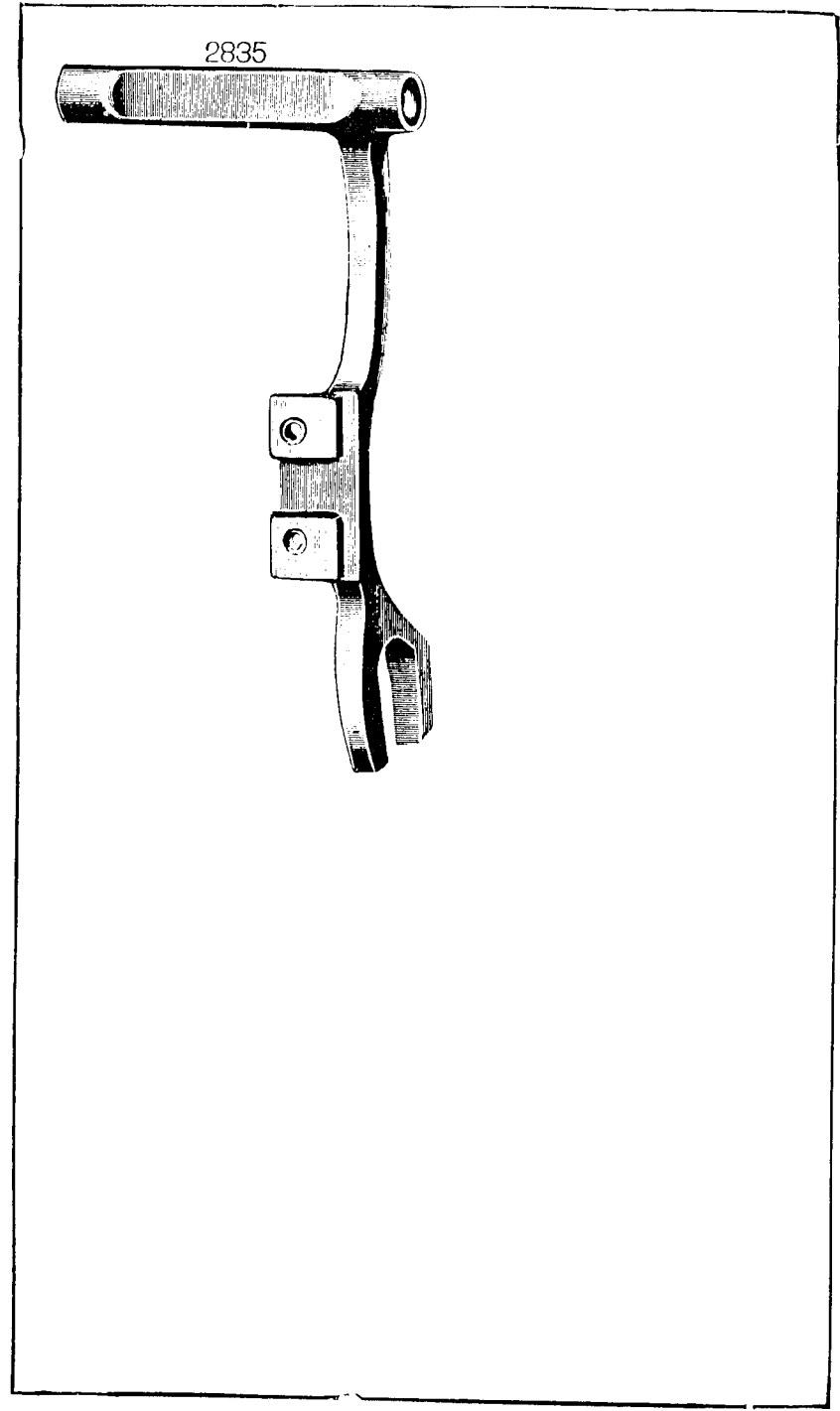

121170

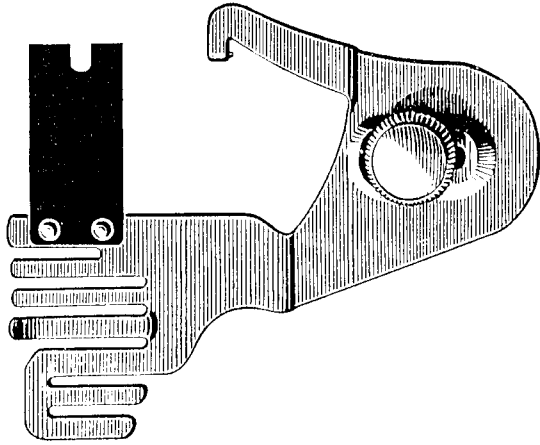

121547

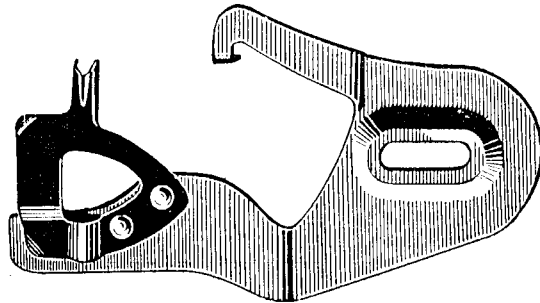

15282

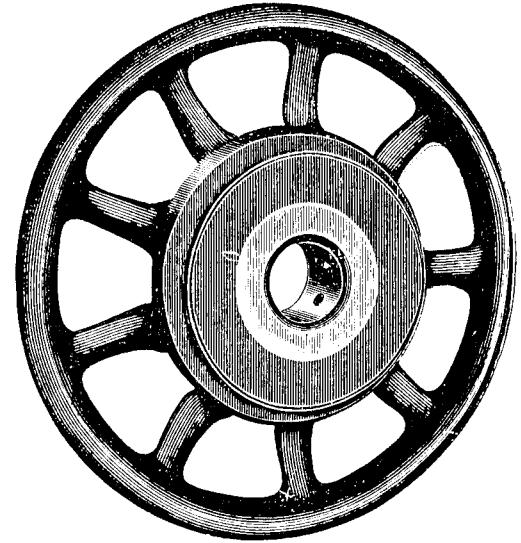

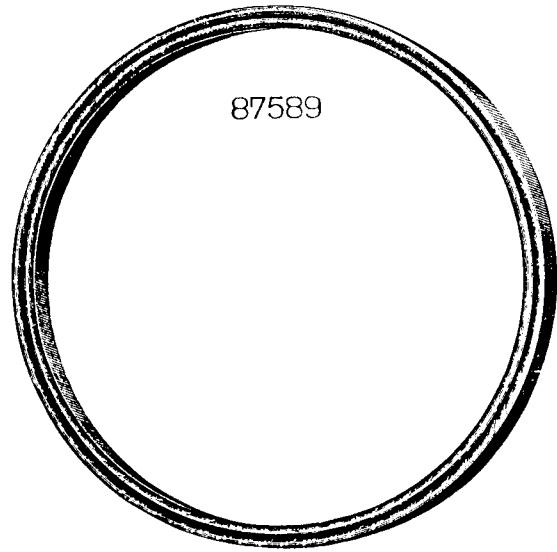

87589

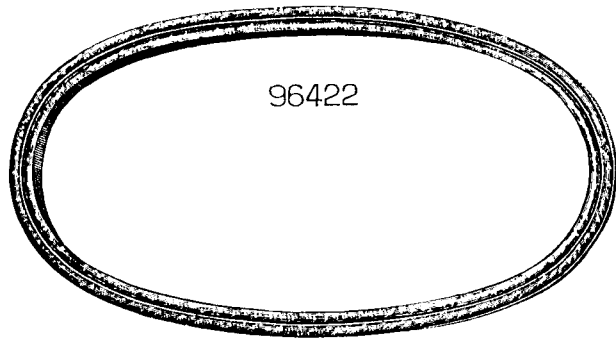

96422

32672

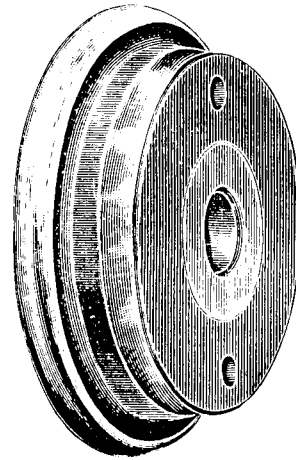

125319

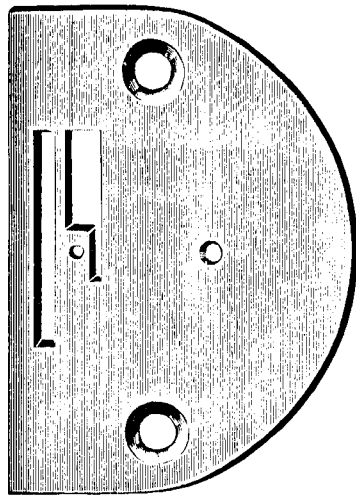

125261

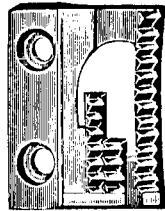

125285



120855



120914



125336

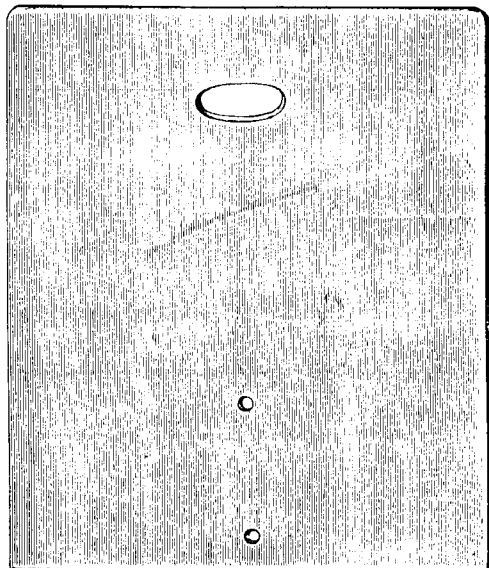

125337

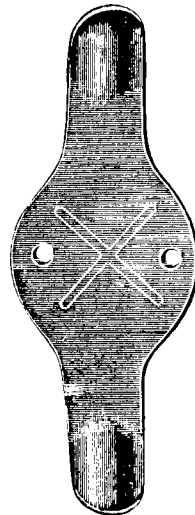

125253



125270



125021



125263



125262

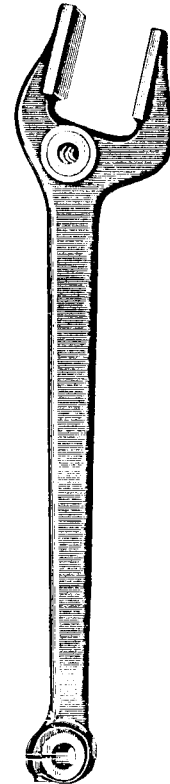

125280

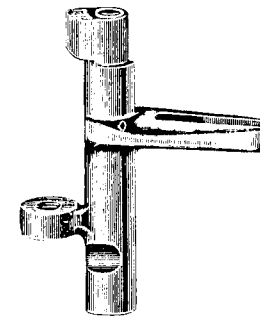

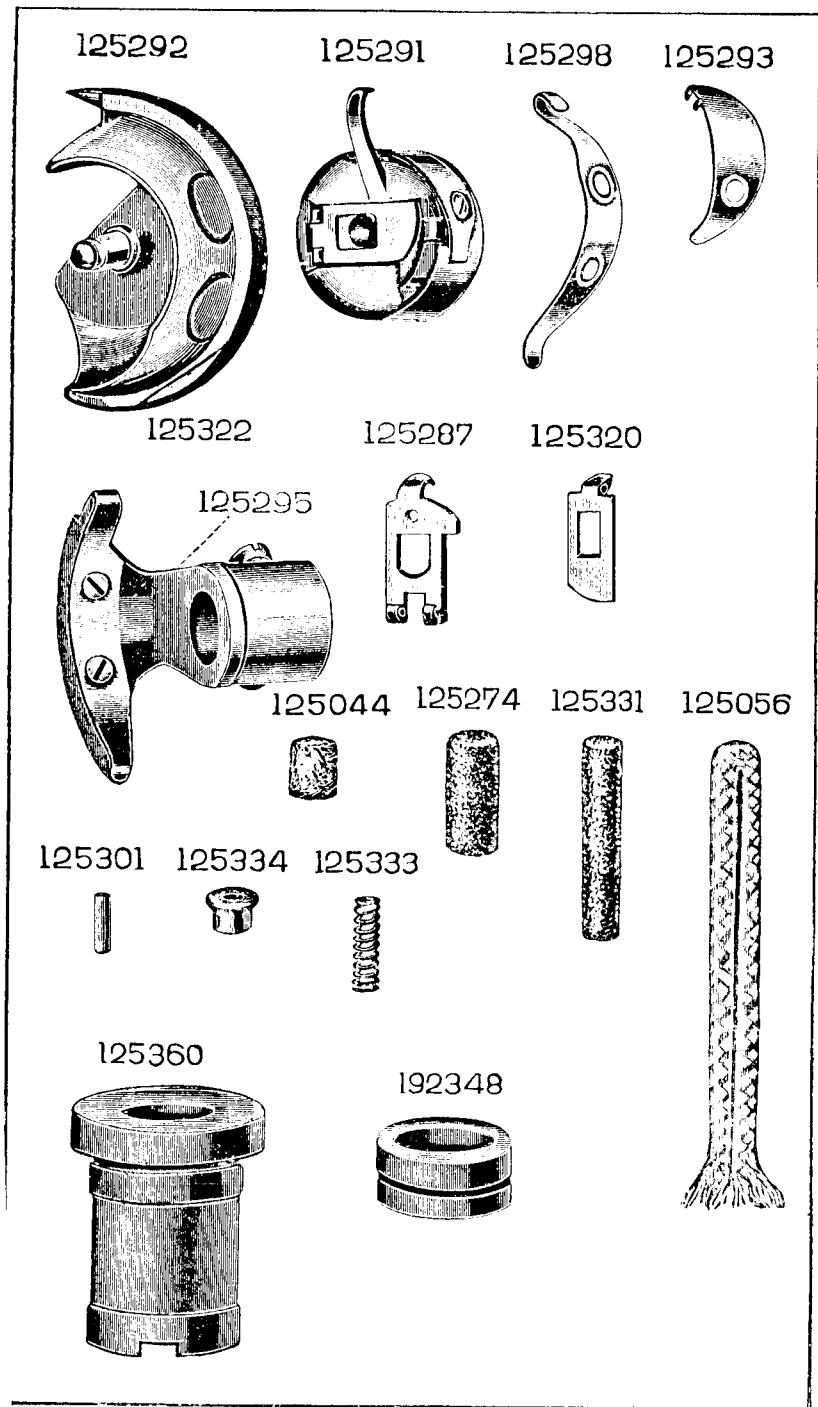
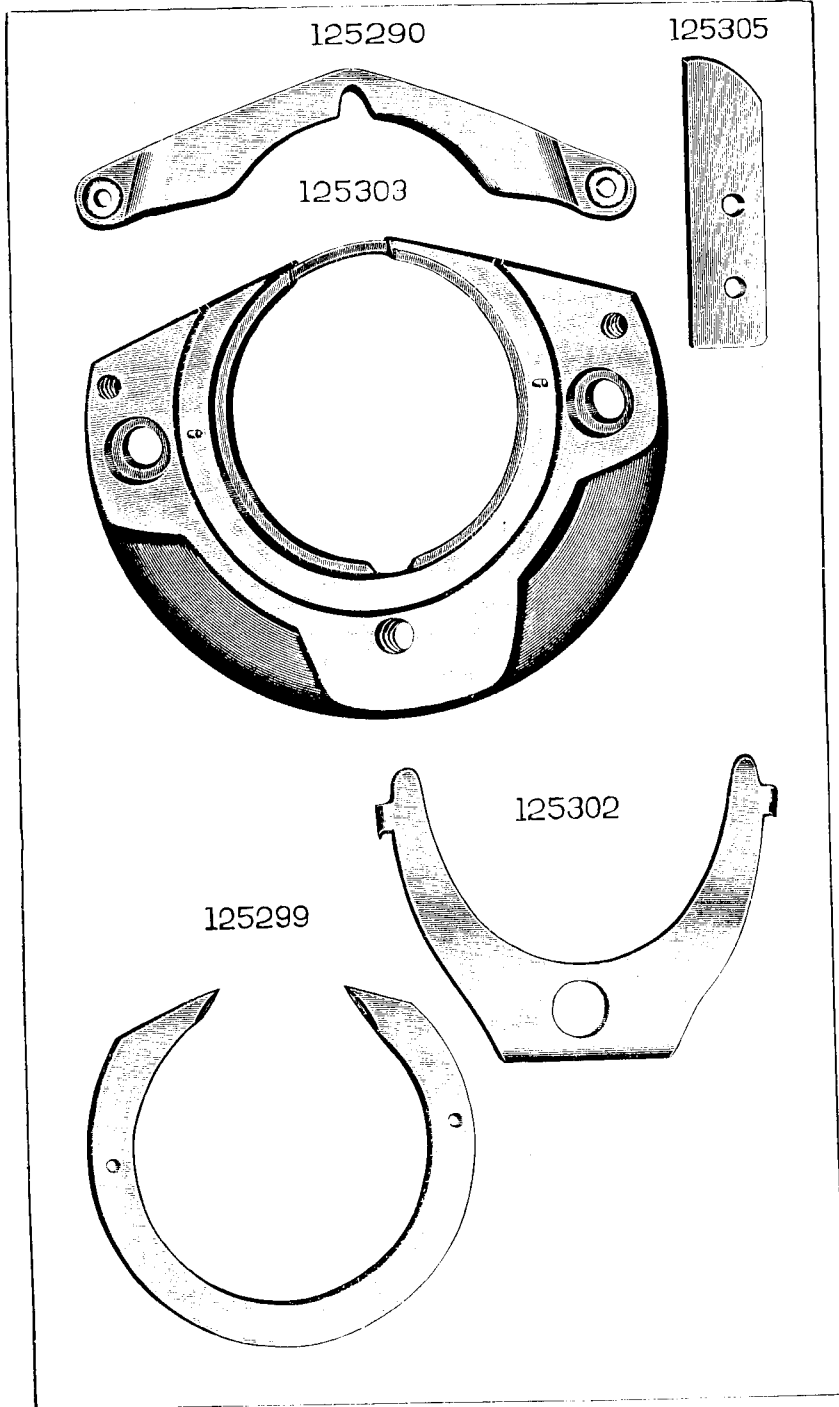

125308

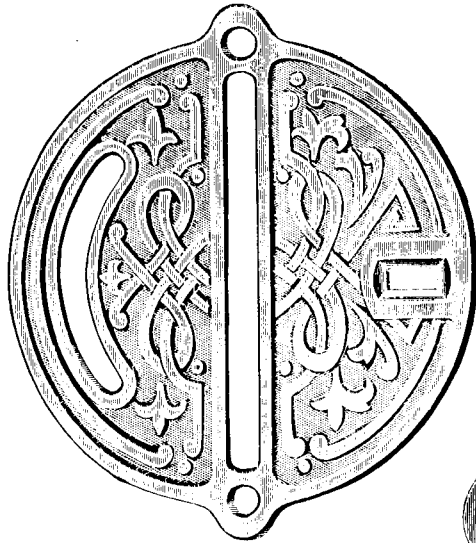

125369



125269

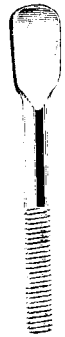

125361

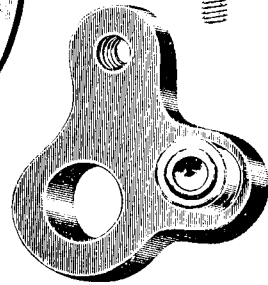

125307

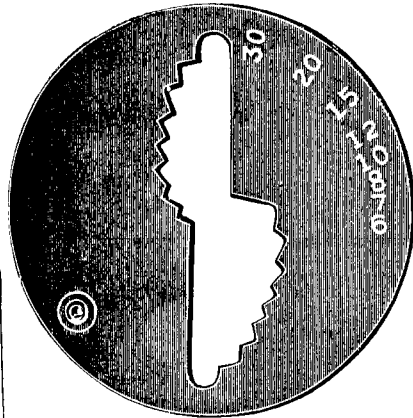

38391



125347

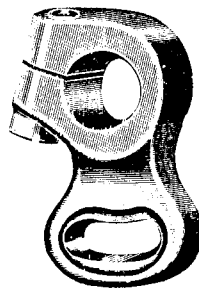

125349



125276



125283

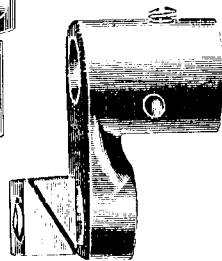

125268

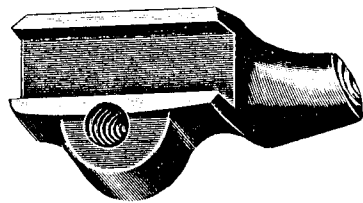

125377

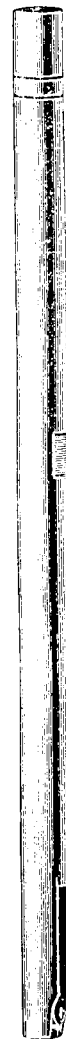

55621

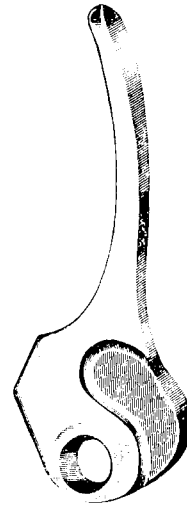

125272



125382

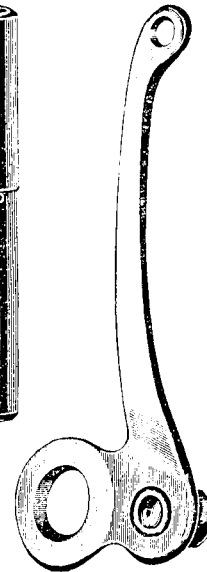

125317

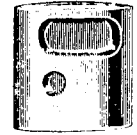

125258

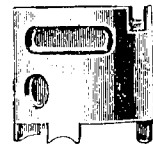

125316

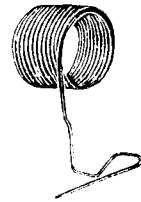

45285



125378



45321

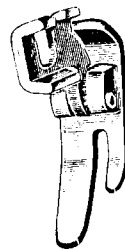

121441

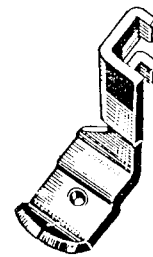

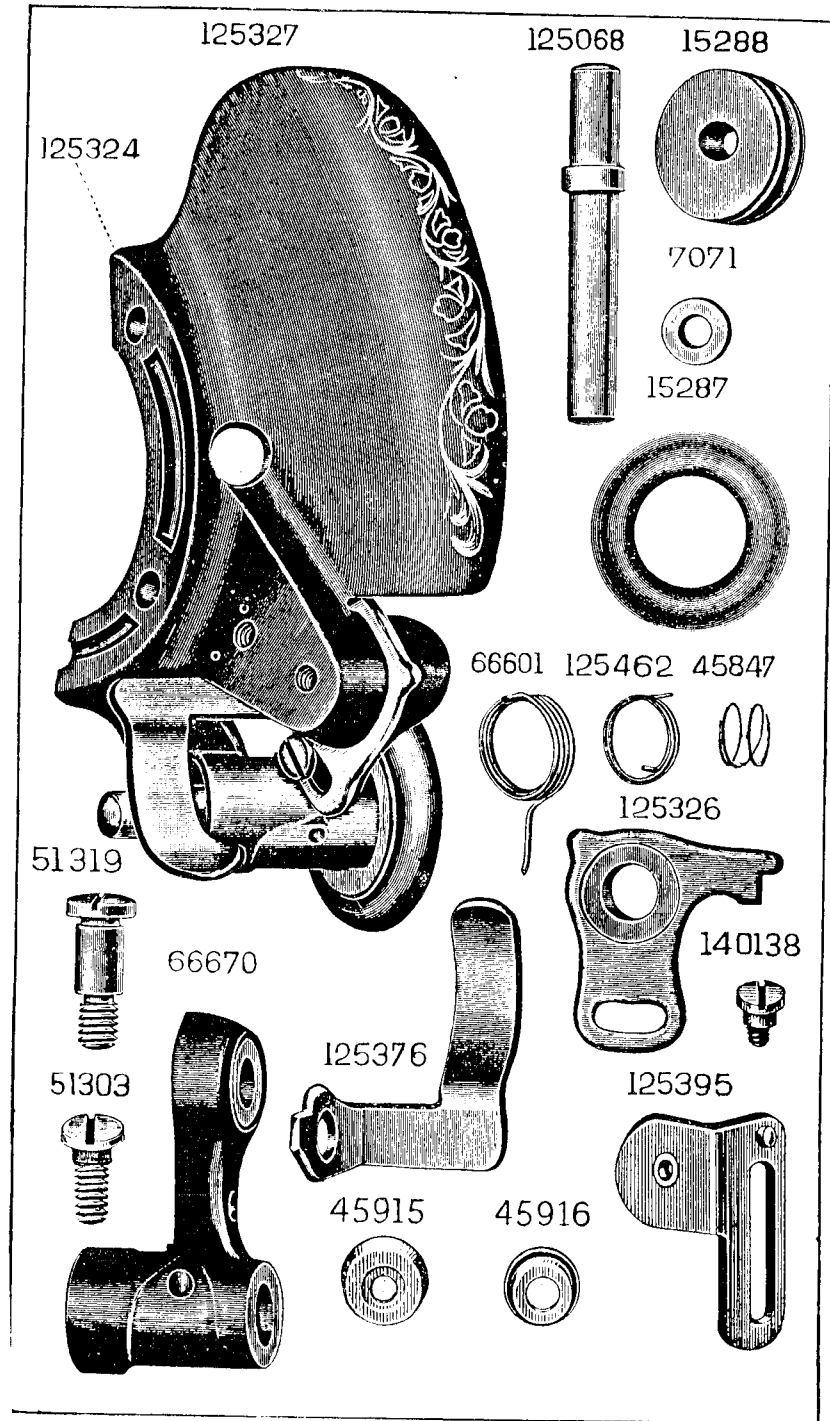
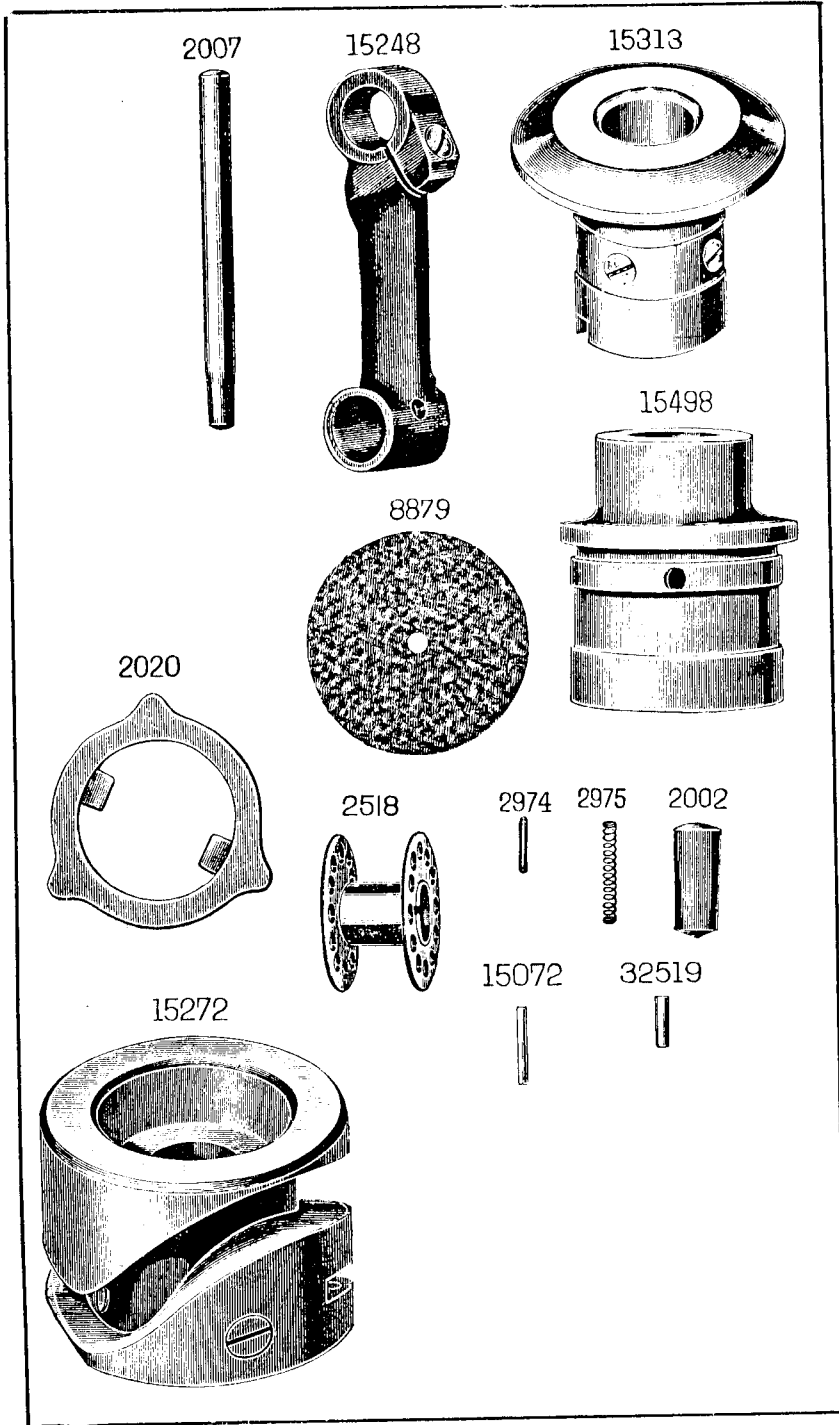

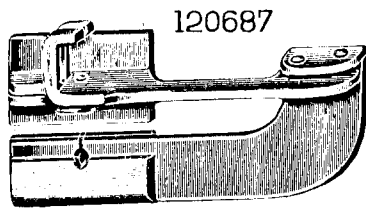

120687

85893



36583

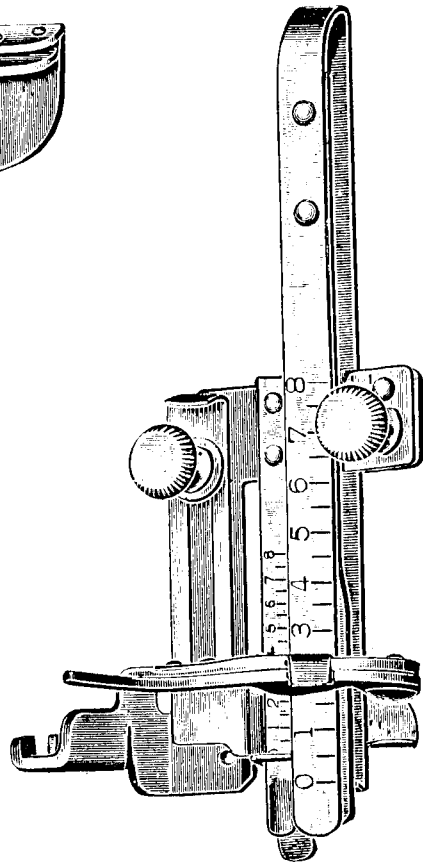

138



145



157



158



175



183



190



193



208



248

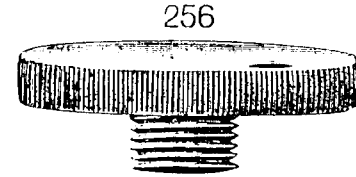

256



304



315



335

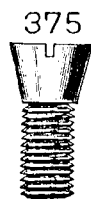

375



391



399



435



448



453



462

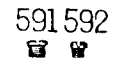

591 592



570



662



691



857



896



1085



1253



1285

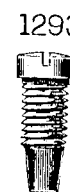

1293



SS528



50053



50292



50353



50527



51002



51224

714



1341



1498



51045



51229



51246



51252

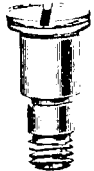

140545



51289



51261

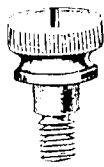

51282



51308



1813



1513

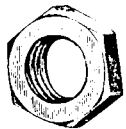

1518



1519



1822



1520



1735



45306

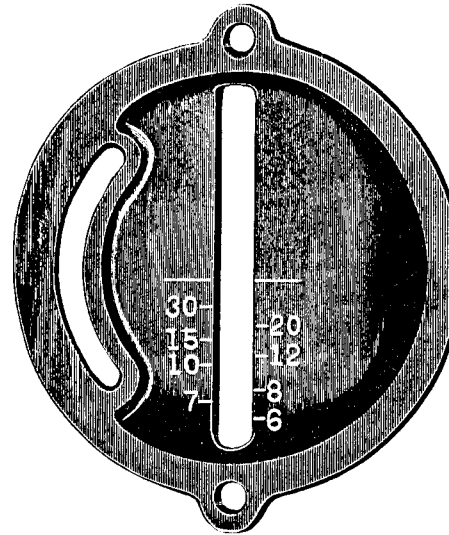

45305



51312



45310



1550



125387

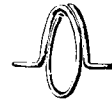

45308

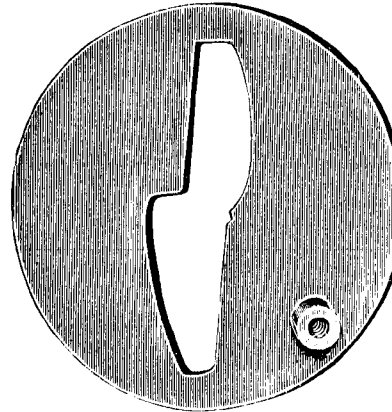

125388

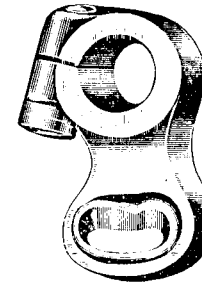

125386

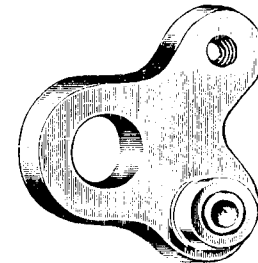

193586

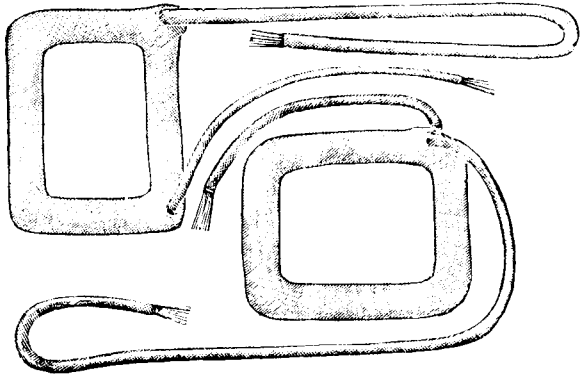

193561

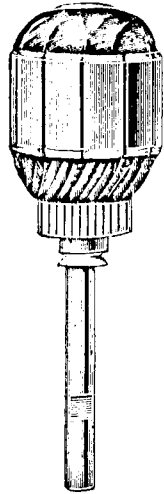

192542



192541



192543



198052

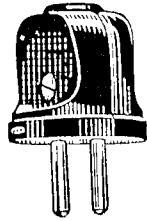

97382



97384

97383

51280

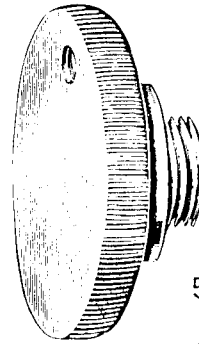

125359

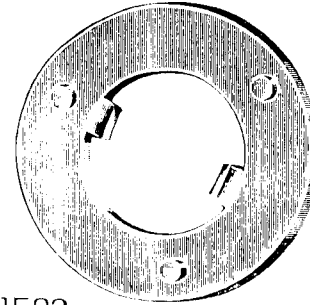

125365

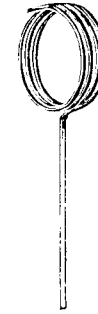

194113

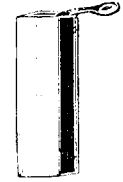

125385



51582



246



51093



51319



192793



192691



192692



701719



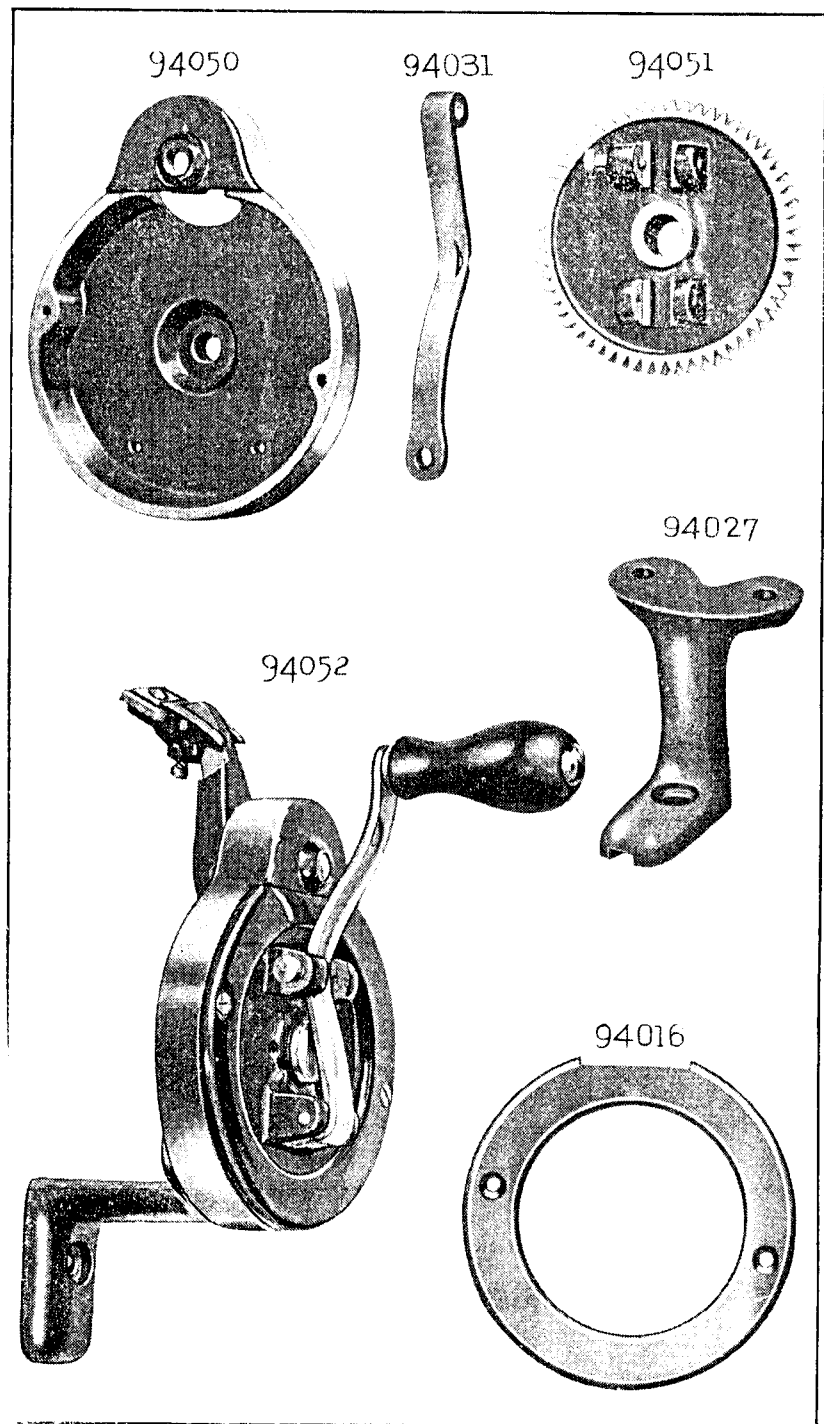
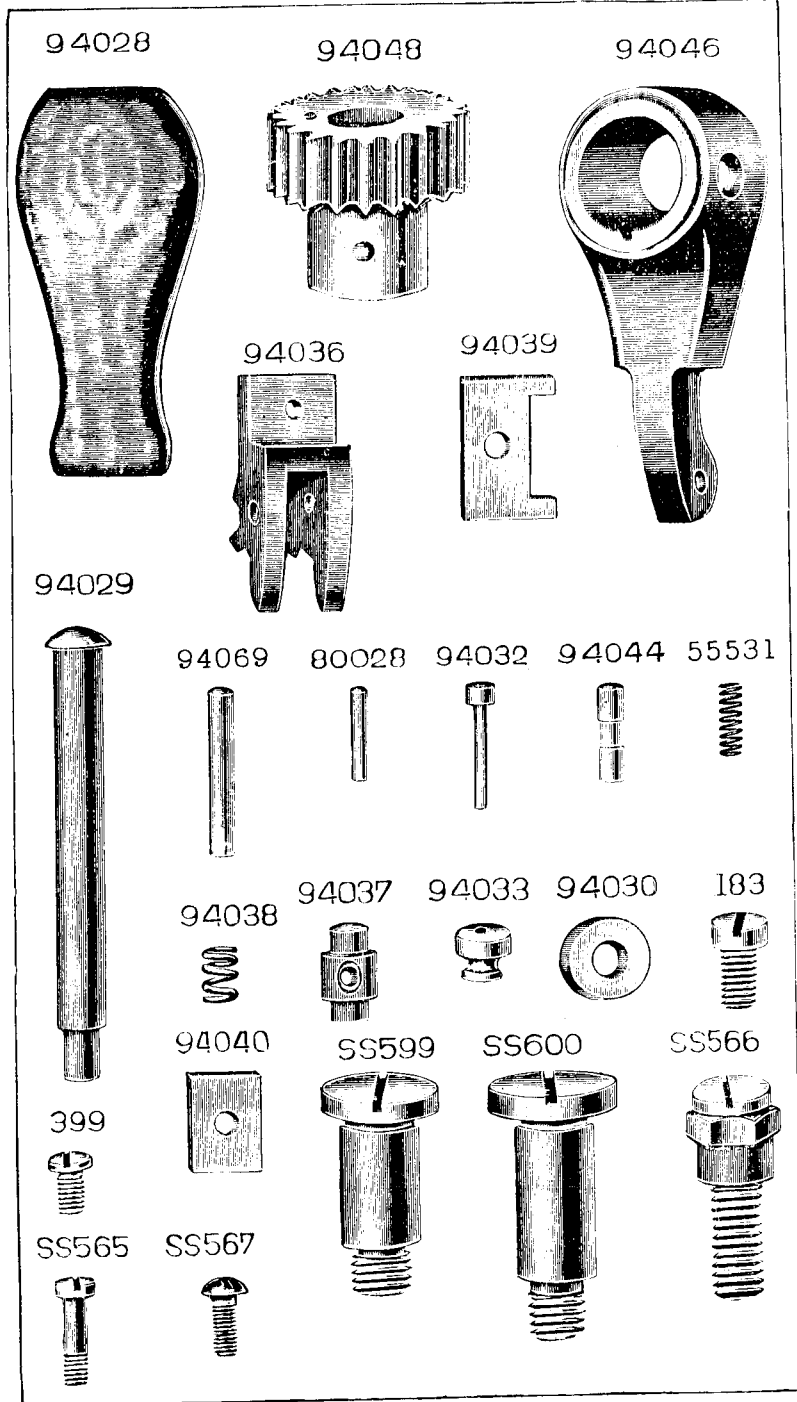

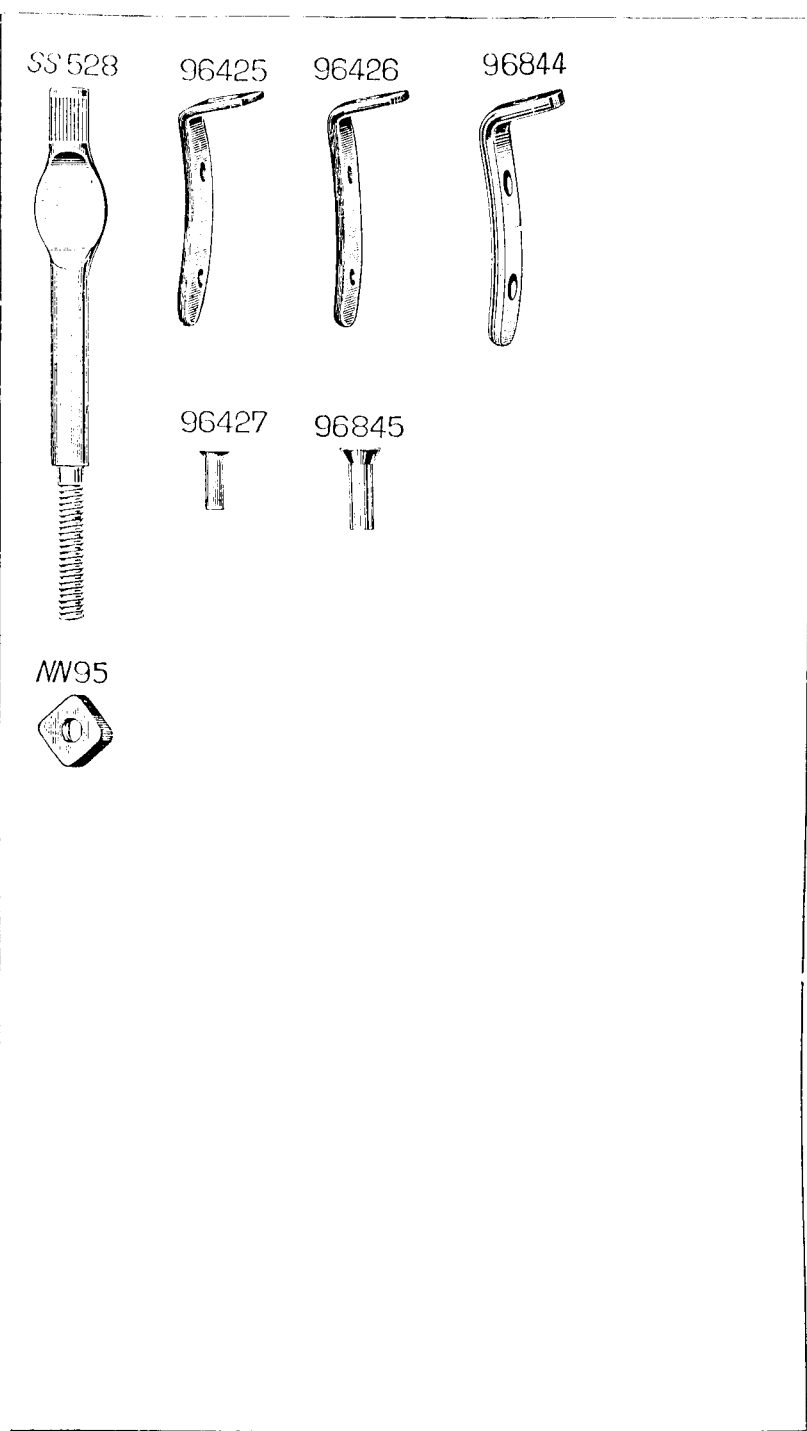
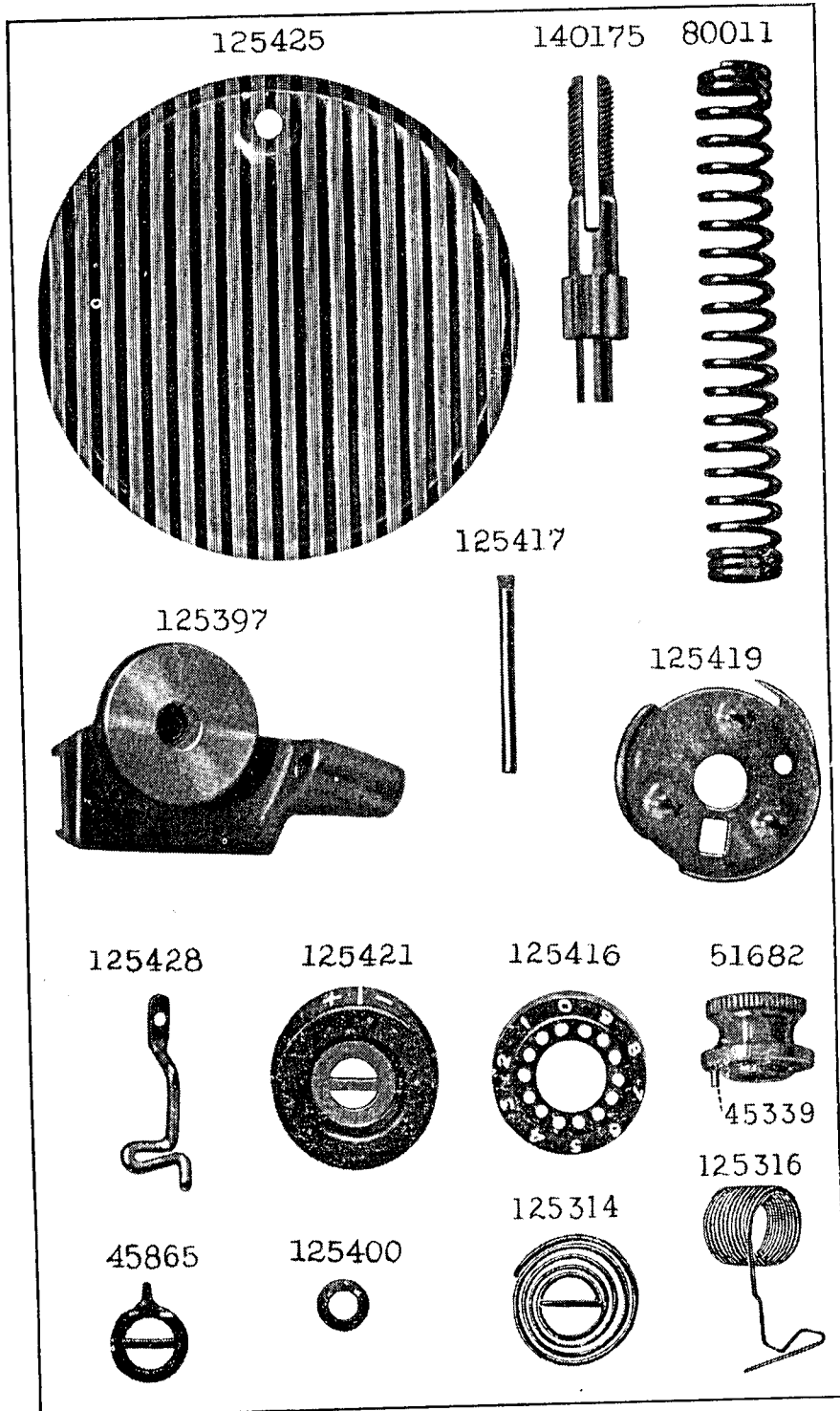

125281



125412

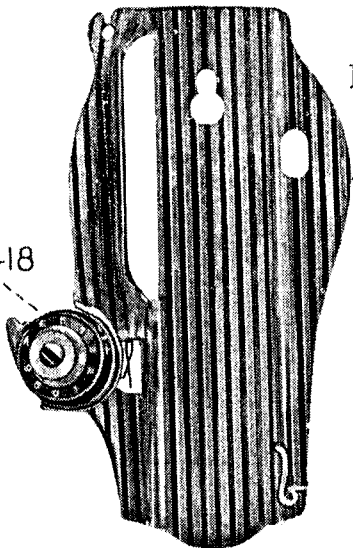

125367

125418



125061



125045

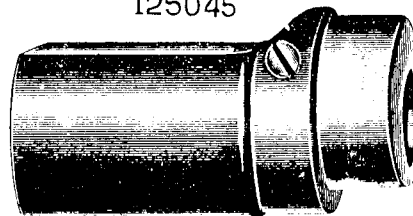

51228

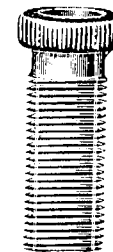

125048

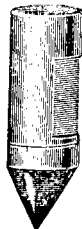

125049



2049



2022



2102

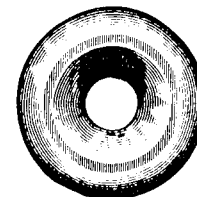

125047



125060



15170



66752



125399

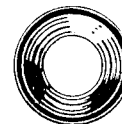

2068

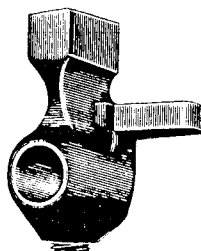

15410



15486

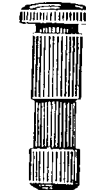

26075



2070



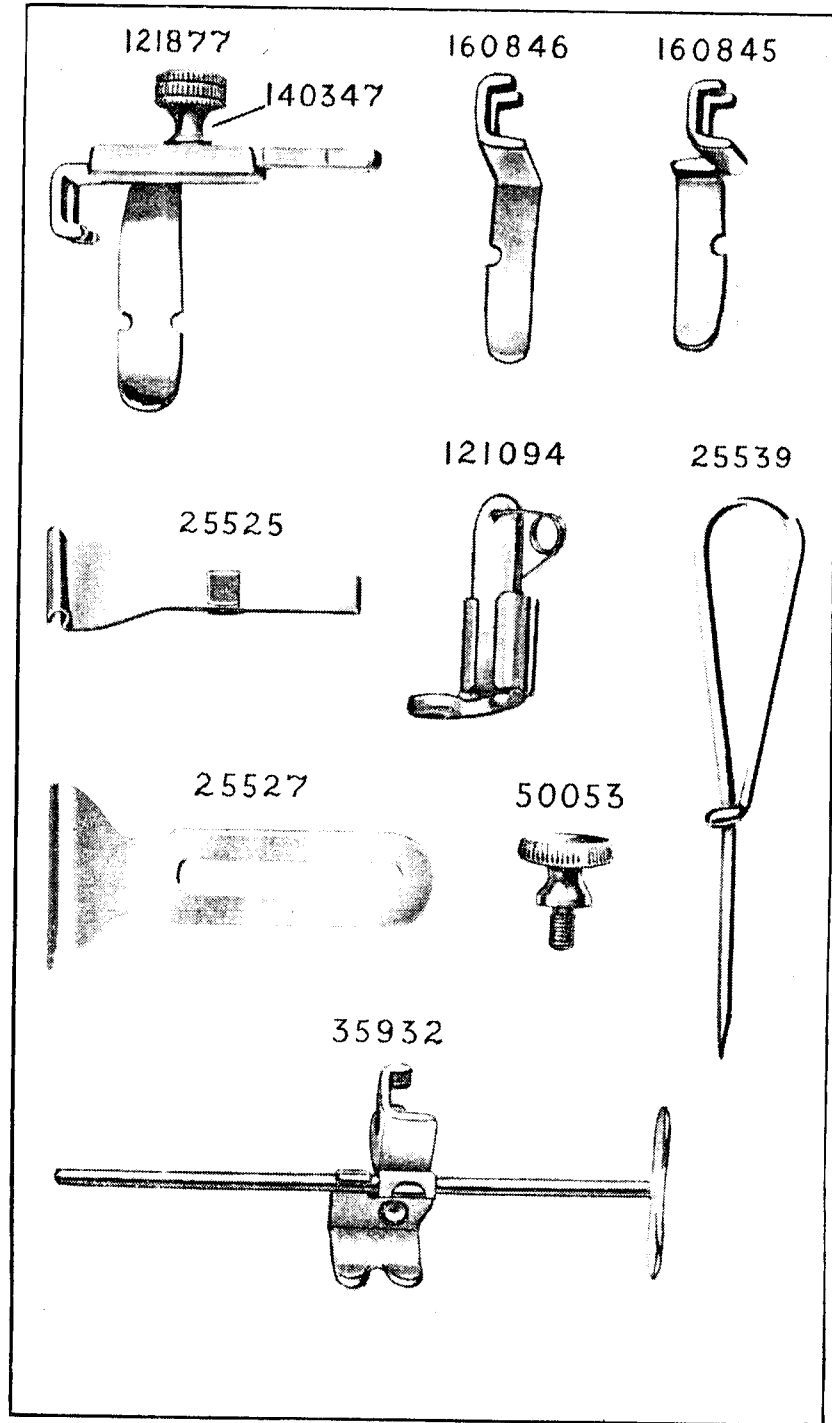
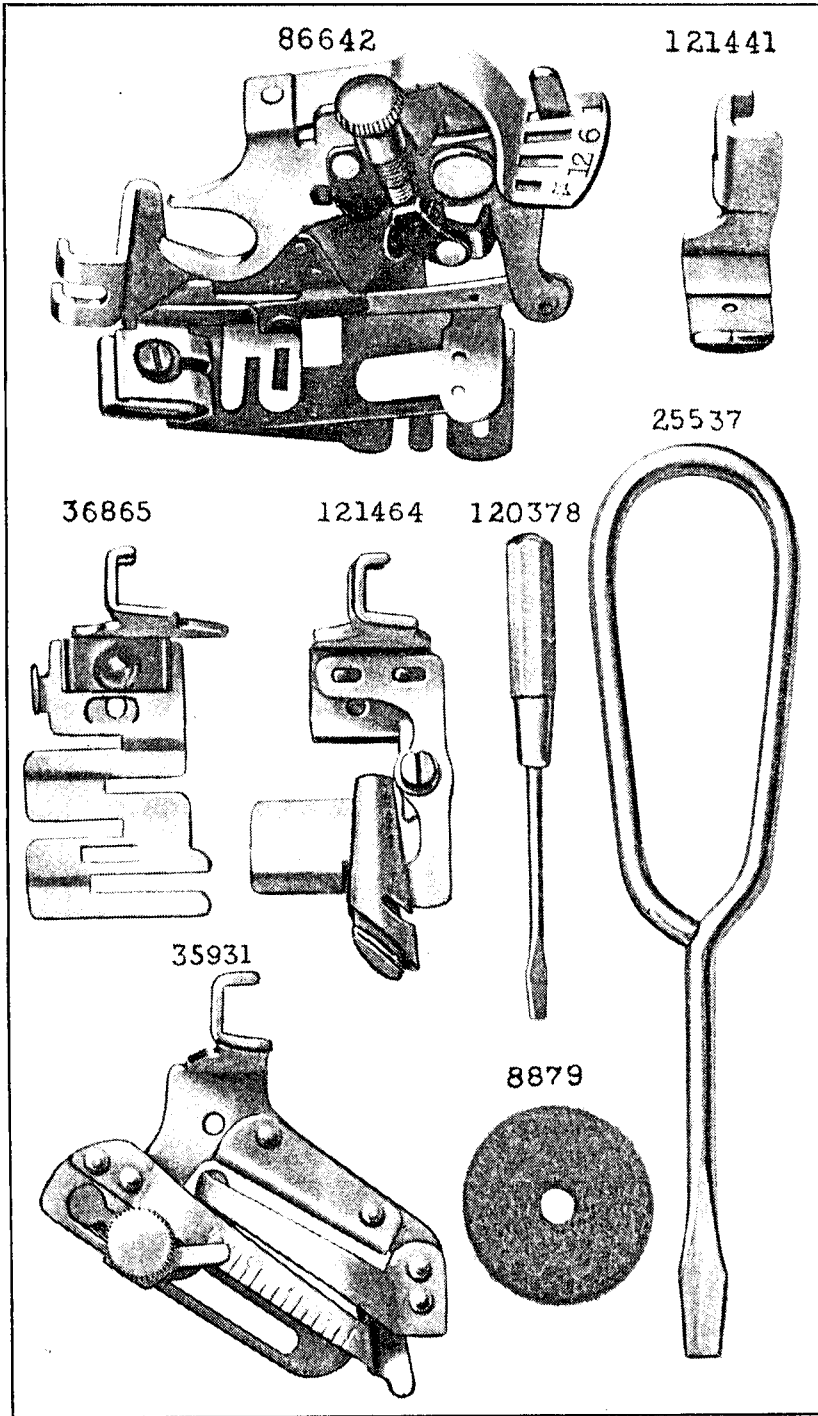
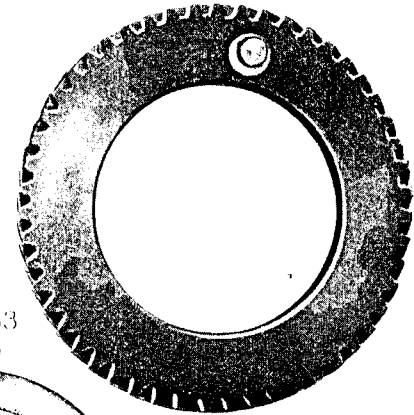
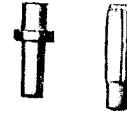

PLATE 4956 - FULL SIZE

125352



125356 125358



125353

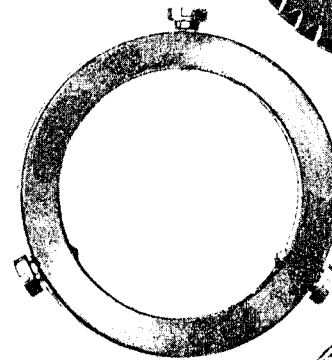

51281 125357



125354

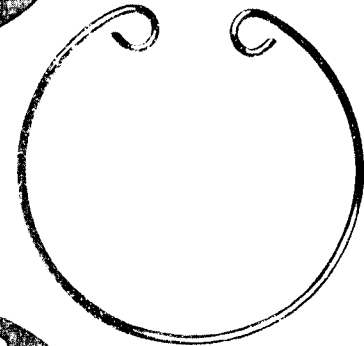

125355

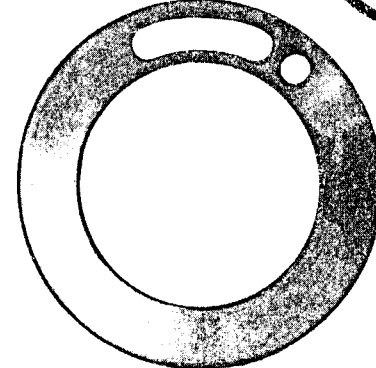

PLATE 4959—FULL SIZE

193523



193529



193524



192457



192458



193640



193546



192459



193542



727511



192790



193527



193526



51284



193543



51285



50617



51286



447



224



882



1768



192424

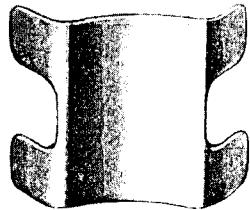
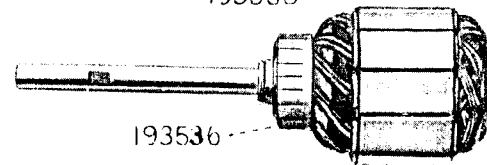

PLATE 4960—ONE-HALF SIZE

193555



193536

193541

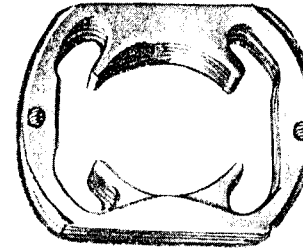

125350

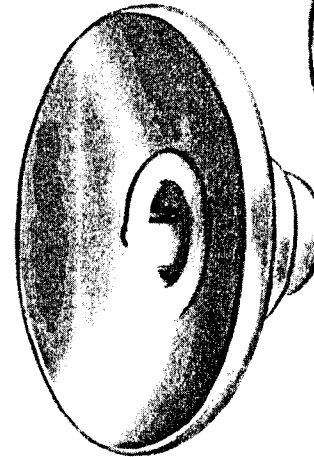

193544

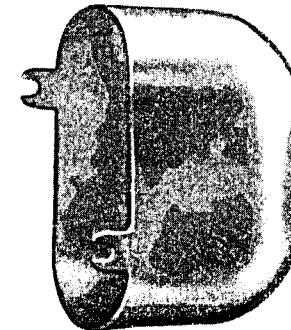

193545

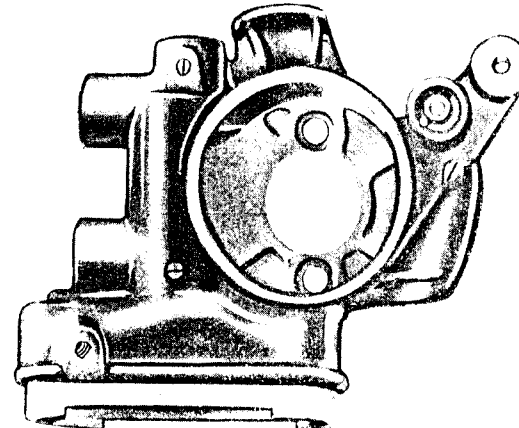
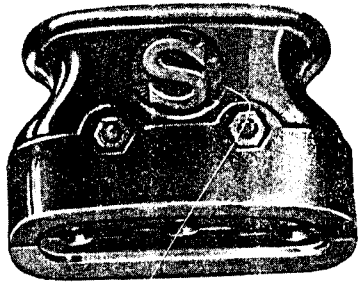
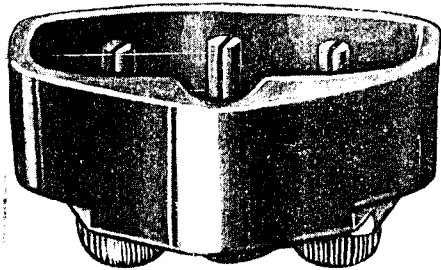

PLATE 4964—FULL SIZE

192989



192797



193629

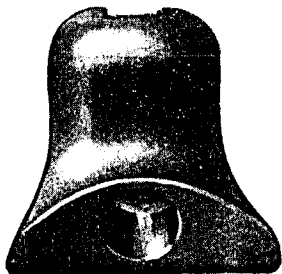

50657



51293



CONTENTS

	Page
Parts complete for 15K88 to 15K90 Machines	47
Parts special to 15K91 Machine	53
Attachments	63
Bobbin Winder	61
Embroidery Hoops	65
Hand Attachment	66
Numerical List of Parts	75
Obsolete Parts	67

LIST OF PARTS

FOR

15K88 to 15K91 Machines

INSTRUCTIONS FOR ORDERING

In ordering from this List, the prefix and affix letters with the part number **MUST BE** quoted exactly as they are shown in the first column.

A number always indicates the same part in whatever List it may appear, or for whatever machine.

The affix letters (where shown) indicate the style of finish, as follows:—

- A. Hardened, Polished, Nickel Plated and Buffed.
- B. Polished, Nickel Plated and Buffed.
- C. Hardened only.
- D. Polished only.
- E. Soft, Not Polished.
- F. Hardened and Polished.
- G. Bright Rumbled and Nickel Plated.
- H. Blued.
- J. Nickel Plated only.
- K. Hardened and Nickel Plated.
- L. Brass Plated.
- M. Oxidized.
- R. Phosphate Coating Formed on Surface of Iron or Steel.
- S. Cadmium Plated.
- T. Copper Plated.
- U. Zinc Plated.
- V. Silver Plated.
- W. Polished and Nickel Plated.
- X. Black Oxide for Iron and Steel.
- Y. Black Nickel Plated only.
- Z. Chromium Plated.
- A.A. Buffed and Chromium Plated.
- A.B. Hardened, Polished, Buffed and Chromium Plated.
- A.E. Hardened, Bright Rumbled and Nickel Plated.
- A.F. Hardened, Bright Rumbled, Nickel Plated, Bright Rumbled and Chromium Plated.
- A.G. Alumilite (Plain).
- A.H. Alumilite (Dyed). Colour must be stated.
- A.J. Polished, Nickel Plated and Chromium Plated.
- A.K. Hardened, Polished, Nickel Plated and Chromium Plated.
- A.L. Heat Treated for Toughness.
- A.L.D. Heat Treated for Toughness and Polished.
- A.L.X. Heat Treated for Toughness and Black Oxide.
- A.S. Black Moulded Phenolic.
- A.T. Beige Moulded Phenolic.
- A.U. Brown Moulded Phenolic.
- A.W. Hardened then Flame Coated with Tungsten Carbide.
- B.A. Chrome Nickel, Satin Finish.
- B.B. Hardened and Chrome Nickel, Satin Finish.
- C.R. Hardened and Phosphate Coating Formed on Surface of Steel.
- C.U. Hardened and Zinc Plated.
- F.J. Hardened, Polished and Nickel Plated.
- T.A. Hardened, Polished, Copper and Nickel Plated and Buffed.
- T.B. Copper and Nickel Plated and Polished.
- T.J. Copper and Nickel Plated only.
- T.K. Hardened, Copper and Nickel Plated.
- T.L. Copper and Brass Plated.
- T.M. Copper Plated and Oxidized.
- X.C. Hardened and Black Oxide for Iron and Steel.
- Z.A. Hardened, Polished, Nickel Plated, Buffed and Chromium Plated.
- Z.B. Polished, Nickel Plated, Buffed and Chromium Plated.
- Z.C. Hardened and Chromium Plated.
- Z.D. Polished and Chromium Plated.
- Z.G. Bright Rumbled, Nickel Plated, Bright Rumbled and Chromium Plated.
- Z.J. Nickel and Chromium Plated.
- Z.T. Copper and Chromium Plated.

Parts marked with an asterisk () are furnished only when the repairs are made at Factory.*

PARTS COMPLETE

FOR

Nos. 15K88 to 15K90 MACHINES

C.B. Shuttle, Reverse Feed, Balanced Machine, for Family Use.

No.	Plate								
25251	--	Arm
25252		"	125251, with 435c, 448c, 15186 and 15198
2002	1954	"	Dowel Pin (2)
25331	1949	"	Oil Pad (felt), for oiling Arm Shaft Back Bearing
25333	1949	"	" " Spring
25334	1949	"	" " " Cap
138e	1957	"	Screw (3)
15253	1947	"	Shaft
5254		"	" 125253 with 15434, 15498 and 125045
5498	1954	"	" Bushing
435c	1957	"	" " Set Screw
5425b	2391	"	Side Cover
1224b	1957	"	" " Thumb Screw
2007	1954	"	Spool Pin
5255		Bed
256b	1957	Clamp Stop Motion Clamp Screw
248a	1957	"	" " " " Stop Screw
2020	1954	"	" " " " Washer
312		"	" " " Flanged Bushing
313	1954	"	" " " " 15312 with two 462al
022	2552	"	" " " " Pin
462al	1957	"	" " " " Set Screw
314		Clamp Stop Motion, complete, Nos. 248a, 256b, 2020 and 15313
021	1947	Crank Connecting Rod with 125012, 125044 and two 896c
012		"	" " " Cap
896c	1957	"	" " " Screw
375c	1957	"	" " " Hinge Screw
518j	1958	"	" " " " Nut
044	1949	"	" " " Oil Pad (felt)
367	2551	Face Plate
84		"	" 125367 with 15410, 125258 and 125369
68		"	" 125384 with 857b, 50292b and 125317
58	1951	"	Tension Seat
28	2391	"	Thread Guard
69	1950	"	" " " 125428 with 125373

No.	Plate			No.	Plate
125373	--	Face Plate	Thread Guard Rivet	125386	1960
125412	2551	" "	125368 with 125418	125349	1950
190b	1957	" "	Screw	1813	1958
				125387	1960
				51289j	1958
2835	792	Feed Bar		
315c	1957	" "	Screw Centre (2)	15282	1152
1519j	1958	" "	" " Nut (2)	32672	1722
125045	2552	Feed Cam and Counterbalance	with 1285c	51045c	1958
1285c	1957	" "	" " Position Screw		
				25377	1951
				25272	1951
125261	1946	Feed Dog, 12 teeth (14 teeth to the inch)	25273	
208al	1957	" "	Screw (2)	25274	1949
				1498c	1958
125262	1947	Feed Forked Connection	with 175j	15248	1954
125340		" "	" " 125262 with 125335	25275	
175j	1957	" "	" " Adjusting Screw	51002c	1957
51252c	1958	" "	" " Hinge Screw (eccentric)	570c	1957
1520j	1958	" "	" " " Nut	1520j	1958
125047	2552	" "	" " Slide Block	15276	1950
125335		" "	" " 125047 with 1085c	1341c	1958
1085c	1957	" "	" " Screw Stud		
				5334	
125263	1947	Feed Lifting Rock Shaft	5285	1951
125388	1960	" "	" " Crank with 157j	5378	1951
157j	1957	" "	" " " Clamping Screw	1308j	1958
125389		" "	" " " complete, Nos. 51289j and 125386 to 125388	0515c	1958
				9519	1954
125390		" "	" " " complete, Nos. 125263, 125349 and 125389		
				5280	1947
304c	1957	" "	" " Screw Centre (2)	5048	2552
125344		" "	" " " 304c with 1513j (2)	1246c	1958
1513j	1958	" "	" " " Nut (2)	5049	2552
				1246c	1958
				3056	1949
125397	2391	Feed Regulator		
125398		" "	" " 125397 with 125381	281	2551
50353c	1957	" "	" " Hinge Screw	363	
125399	2552	" "	" " " Friction Washer		
				282	
45305	1960	Feed Reversing Handle	283	1950
125381		" "	" " 45305 with 1550j	284	
1550j	1960	" "	" " Lock Nut	049	2552
				462al	1957
125270	1947	Feed Rock Shaft	170	2552
304c	1957	" "	" " Screw Centre (2)	330	
125344		" "	" " " 304c with 1513j (2)	060	2552
1513j	1958	" "	" " " Nut (2)		

Feed Throw-out Lever	with 1813
" "	" Retaining Ring
" "	" Roller and Stud
" "	" Spring
" "	" Thumb Screw
Hand Wheel, 2 1/4" pulley,	for 15K88 and 15K89 Machines
" "	3 1/4" pulley, for 15K90 Machine
Machine Hinge Connection Set Screw	(2)
Needle Bar	with 92519
" "	Bushing
" "	" 125272 with 125274
" "	" Oil Pad (felt)
" "	" Set Screw
" "	" Connecting Link with 51002c
" "	" " 15248 with 125276
" "	" Adjusting Screw
" "	" Hinge Screw
" "	" " " Nut
" "	" Stud with 1341c
" "	" Set Screw
Needle Clamp	with 140545c
" "	45334 with 51308j
" "	Gib and Thread Guard
" "	Position Screw
" "	Thumb Screw
" "	Stop Pin
Oscillating Rock Shaft	with 125056
" "	" Centre (left)
" "	" (") Set Screw
" "	" (right)
" "	" (") Set Screw
" "	" Oil Wick (braided cotton)
Oscillating Shaft
" "	125281 with 2049 and 125295
" "	125363 with 125283, 125298 and two 51229e
" "	Crank
" "	" 125282 with 462al and 125330
" "	" 125282 with 125330 and two 462al
" "	" Pin
" "	" Set Screw
" "	" Slide Block
" "	" " 15170 with 125060
" "	" Stud

No.	Plate						
125061	2552	Presser Bar
55621	1951	"	"	Lifter
15486	2552	"	"	"	Hinge Stud
448c	1957	"	"	"	"	Set Screw	...
80011	2391	"	"	"	Spring
2068	2552	"	"	"	Bracket with 453c
453c	1957	"	"	"	"	Set Screw	...
2070	2552	"	"	"	Washer
45329	-	Presser Foot	Hinge Pin
45319	-	"	"	Plate
*32774	-	"	"	Shank
45321	1951	Presser Foot	(hinged), complete, Nos. 32774, 45319 and 45329				
<i>NOTE.—No. 45321 is sent with machine unless otherwise specified on order.</i>							
125285	1946	Presser Foot
51224b	1957	"	"	Thumb Screw
*51228b	2552	Pressure Regulating Thumb Screw
66773	-	"	"	"	"	51228b with 66752	...
66752	2552	"	"	"	"	Plug (felt)	...
2518	1954	Shuttle Bobbin
125287	1949	"	"	"	Case Latch
125320	1949	"	"	"	"	Lever	...
2974	1954	"	"	"	"	Fulcrum Pin	...
2975	1954	"	"	"	"	Spring	...
592e	1957	"	"	"	"	Stop Screw	...
125288	-	"	"	"	"	Hinge, Nos. 2974, 125287 and 125320	...
125290	1948	"	"	"	"	Position Plate	...
391j	1957	"	"	"	"	"	Screw
125291	1949	"	"	"	"	with 591f, 592e, 2975, 125288 and 125293	...
125292	1949	"	"	"	"	Body	...
591f	1957	"	"	"	"	Tension Regulating Screw	...
125293	1949	"	"	"	"	Spring	...
125294	-	Shuttle , 1 $\frac{1}{8}$ " diam., complete, Nos. 2518, 125291 and 125292
*125295	1949	Shuttle Driver
125297	-	"	"	"	"	125295 with two 1253c	...
125322	1949	"	"	"	"	125297 with 125298 and two 51229e	...
125298	1949	"	"	"	"	Cushion Spring	...
51229e	1958	"	"	"	"	"	Screw
2049	2552	"	"	"	"	Pin	...
1253c	1957	"	"	"	"	Set Screw	...

No.	Plate						
125299	1948	Shuttle Race Back
125301	1949	"	"	"	Position Pin
125302	1948	"	"	"	Spring
51261j	1958	"	"	"	"	Thumb Screw	...
125303	1948	"	"	"	Body
125304	-	"	"	"	"	125303 with 125305 and two 662j	...
125300	-	"	"	"	"	125304 with 125290, two each 391j and 125301	...
125305	1948	"	"	"	Cap
662j	1957	"	"	"	"	Screw	...
125306	-	Shuttle Race , complete, Nos. 51261j, 125299, 125300 and 125302
145j	1957	"	"	"	"	Screw (2)	...
125336	1946	Shuttle Race Slide
125337	1946	"	"	"	Spring
51282j	1958	"	"	"	"	Screw	...
125338	-	Shuttle Race Slide , complete, Nos. 125336, 125337 and two 51282j
45306	1960	Stitch Indicator Plate
335b	1957	"	"	"	"	Screw (2)	...
45307	-	Regulating Plate
45308	1960	"	"	"	"	45307 with 45289	...
45309	-	"	"	"	"	45308 with 45306, 45310, 51312b and 125400	...
51312b	1960	"	"	"	"	Thumb Screw	...
45289	-	Bushing
125400	2391	"	"	"	"	Friction Washer	...
45310	1960	"	"	"	"	Washer (fibre)	...
2102	2552	Tension Disc
125421	2391	"	"	"	"	Indicator	...
125416	2391	"	"	"	"	Flange	...
45865	2391	"	"	"	"	Stop Washer	...
51682b	2391	"	"	"	"	Regulating Thumb Nut with 45339	...
45339	2391	"	"	"	"	"	Engaging Pin
125417	2391	"	"	"	"	Releasing Pin	...
125314	2391	"	"	"	"	Spring	...
140175c	2391	"	"	"	"	Stud	...
125420	-	"	"	"	"	140175c with 51682b	...
15410	2552	"	"	"	"	Bushing	...
50292b	1957	"	"	"	"	Set Screw	...
25418	-	Tension , complete, Nos. 45865, 125314, 125316, 125416, 125417, 125419 to 125421 and two 2102
26075	2552	Thread Cutter and Holder

No.	Plate						
15272	1954	Thread Take-up Cam	with 1293al
*15434	---	"	"	"	15272 with 570c and 1520j
1293al	1957	"	"	"	Timing Screw
*125382	1951	Thread Take-up Lever	with 1822
125383	---	"	"	"	125382 with 50527c
50527c	1957	"	"	"	Hinge Screw
1822	1958	"	"	"	Roller and Stud
125316	2391	Thread Take-up Spring	
125317	1951	"	"	"	Regulator
857b	1957	"	"	"	" Set Screw
125419	2391	"	"	"	Thread Guard
125319	1946	Throat Plate	for 125261
691a	1957	"	"	"	Screw (2)
125029	---	Drip Pan	(for Cover Set)

PARTS SPECIAL

TO

No. 15K91 MACHINE

(OBSOLETE)

**C.B. Shuttle ; Reverse Feed ; Balanced Machine ; Solid Hand Wheel ;
P.G. Motor and SINGER Light ; for Family Use.**

This machine is the same as No. 15K88 with the following exceptions :

No.	Plate						
51280b	2091	Clamp Stop Motion Clamp Screw	
246a	2091	"	"	"	"	Stop Screw	...
125359	2091	"	"	"	"	Washer	...
125360	1949	"	"	"	"	Flanged Bushing	...
*125371	---	"	"	"	"	"	125360 with 51280b
125372	---	"	"	"	"	"	125360 with two 462al
125350	4960	Hand Wheel	with 125358
125364	---	"	"	"	"	125350 with 125352 to 125355 and two 125385	...
125351	---	"	"	"	"	Gear (textolite)	...
125352	4956	"	"	"	"	125351 with 125356 and 125357	...
125353	4956	"	"	"	"	Collar with three 51281c	...
51281c	4956	"	"	"	"	Set Screw	...
125354	4956	"	"	"	"	Spring	...
125385	2091	"	"	"	"	Cushion Pin (eccentric)	...
125355	4956	"	"	"	"	Retaining Washer	...
125356	4956	"	"	"	"	Stud	...
125357	4956	"	"	"	"	" Washer	...
125358	4956	"	"	"	"	Spring Stud	...

MOTOR PARTS

No.	Plate	
193555	4960	Armature, complete, for P.G.K. 3 Motor
193556	---	" " " P.G.K. 5 Motor
193557	---	" " " P.G.K. 6 Motor
193557	---	" " " P.G.K. 7 Motor
193558	---	" " " P.G.K. 8 Motor
193559	---	" " " P.G.K. 9 Motor
193560	---	" " " P.G.K. 10 Motor
193561	2090	" " " P.G.K. 11 Motor
193561	2090	" " " P.G.K. 12 Motor
193562	---	" " " P.G.K. 15 Motor
193563	---	" " " P.G.K. 87 Motor
193564	---	" " " P.G.K. 90 Motor
193560	---	" " " P.G.K. 92 Motor
*193540	---	Armature Core, complete
*193528	---	" Shaft
193523	4959	" " Bearing Sleeve (commutator end)
447c	4959	" " " " (" ") Set Screw
193524	4959	" " " " (front end)
50617b	4959	" " " " (" ") Cap Screw
447c	4959	" " " " (" ") Set Screw
193542	4959	" " Oil Sling
193529	4959	" " Pinion (spiral) with two 462al
462al	1957	" " " Set Screw
931275	---	" Wire Separator (linen)
194591	---	Brush (carbon) for 25 and 32 volts
192457	4959	" (") " 50 to 145 volts (2)
193799	---	" (") " 150 to 250 volts (2)
193543	4959	" Cap (2)
192458	4959	" Spring (2)
194113	2091	" Tube (2)
193546	4959	" " Insulating Bushing (2)
882e	4959	" " " " Set Screw
193536	4960	Commutator, complete
193566	---	Field Coil (left) for 193565
193567	---	" " (right) for 193565
193565	---	Field Coil, complete, Nos. 193566 and 193567, for P.G.K. 3 Motor
193569	---	Field Coil (left) for 193568
193570	---	" " (right) for 193568
193568	---	Field Coil, complete, Nos. 193569 and 193570, for P.G.K. 5 Motor
193572	---	Field Coil (left) for 193571
193573	---	" " (right) for 193571
193571	---	Field Coil, complete, Nos. 193572 and 193573, for P.G.K. 6 Motor
193575	---	Field Coil (left) for 193574
193576	---	" " (right) for 193574
193574	---	Field Coil, complete, Nos. 193575 and 193576 for P.G.K. 7 Motor

MOTOR PARTS

No.	Plate	
193578	---	Field Coil (left) for 193577
193579	---	" " (right) for 193577
193577	---	Field Coil, complete, Nos. 193578 and 193579 for P.G.K. 8 Motor
193581	---	Field Coil (left) for 193580
193582	---	" " (right) for 193580
193580	---	Field Coil, complete, Nos. 193581 and 193582 for P.G.K. 9 Motor
193584	---	Field Coil (left) for 193583
193585	---	" " (right) for 193583
193583	---	Field Coil, complete, Nos. 193584 and 193585 for P.G.K. 10 and P.G.K. 11 Motors
193587	---	Field Coil (left) for 193586
193588	---	" " (right) for 193586
193586	2090	Field Coil, complete, Nos. 193587 and 193588 for P.G.K. 12 Motor
193590	---	Field Coil (left) for 193589
193591	---	" " (right) for 193589
193589	---	Field Coil, complete, Nos. 193590 and 193591 for P.G.K. 15 Motor
193593	---	Field Coil (left) for 193592
193594	---	" " (right) for 193592
193592	---	Field Coil, complete, Nos. 193593 and 193594 for P.G.K. 87 Motor
193596	---	Field Coil (left) for 193595
193597	---	" " (right) for 193595
193595	---	Field Coil, complete, Nos. 193596 and 193597 for P.G.K. 90 Motor
193599	---	Field Coil (left) for 193598
193600	---	" " (right) for 193598
193598	---	Field Coil, complete, Nos. 193599 and 193600 for P.G.K. 92 Motor
727511	4959	Field Coil Lead Bushing (rubber)
195834	---	" " " Terminal Clip (2)
192424	4959	Field Coil Retainer (2)
193541	4960	" Core, complete
51286r	4959	" " Screw (2)
193526	4959	Grease Wick
193525	---	" " 193526 with 193527 (2)
193527	4959	" " Spring
51284r	4959	" " " Cap Screw (2)
193640	4959	" " " Retainer (2)
*192852	---	Lead Cord
192851	---	Lead Cord, complete, from lamp socket to three-pin terminal, for Knee and Treadle Control, Nos. 192790, 192852, 192989 and Plug

MOTOR PARTS

No.	Plate		No.	Plate	
*192820	---	Lead Cord, 8ft. long, for 192875	198052	2090	Two-Pin Plug
192874	---	" " 3 ft. 10 ins. long, for 192875	198108	" "	(Norwegian)
192875	---	Lead Cord, complete, from lamp socket to three-pin terminal and controller, for Foot Controller, Nos. 192348, 192820, 192874, 192989, Plug and two 195834	198138	" "	(Danish)
192348	1949	Lead Bushing	198367	" "	(Swiss)
195834	---	Lead Terminal Clip	97382	2090	Bayonet Plug, complete, Nos. 97383 and 97384
193544	4960	Motor Cover	97383	2090	" " Body for 97382
224b	4959	" " Screw (2)	97384	2090	" " Cover for 97382
193522	---	" Frame	192540	---	Screw Plug, complete, Nos. 192541 and 192542
193545	4960	" " 193522 with 193523, 193524, two each 447c and 882c	192541	2090	" " Base for 192540
*193644	---	Motor Frame 193545 with 190b, 51303b, 51319b, 125326, 125365, 125366, 125376 and 125462	192542	2090	" " Cap with 192543 for 192540
51285e	4959	Motor Frame Screw (2)	192543	2090	" " Flash Disc (fibre) for 192542
899418	---	Name Plate for P.G.K. 7 Motor			
899419	---	" " " all P.G.K. Motors except P.G.K. 7			
192790	4959	Three-Pin Terminal Adaptor Bushing			
*192643	---	" " (female half) Housing (upper)			
*192644	---	" " (" ") " (lower)			
51093r	2091	" " (" ") " Screw			
1768r	4959	" " (" ") " " Nut			
192692	2091	" " (" ") Insert Clamp			
192691	2091	" " (" ") " Sleeve			
192989	4964	Three-Pin Terminal (female half), complete, Nos. 192643, 192644, two each 1768r, 51093r, three each 192691 and 192692			
*192642	---	Three-Pin Terminal Body (male half)			
*193700	---	" " " (" ") 192642 with three 192793			
192793	2091	" " " (male half) Post			
51582	2091	" " " (" ") " Thumb Nut			
701719	2091	" " " (" ") " Washer			
192797	4964	Three-Pin Terminal Body (male half), complete, Nos. 193700, three each 51582 and 701719			
193629	4964	Three-Pin Terminal Body (male half) Bracket			
51293e	4964	" " " (" ") " Screw			
50657r	4964	" " " (" ") Screw			
190439	---	Tube, filled with Singer Lubricant, for Electric Motors			
190613	---	" 190439 with 190612			
190612	---	" Carton (paper)			

PLUGS

No.	Plate		No.	Plate	
198052	2090	Two-Pin Plug			
198108	" "	(Norwegian)			
198138	" "	(Danish)			
198367	" "	(Swiss)			
97382	2090	Bayonet Plug, complete, Nos. 97383 and 97384			
97383	2090	" " Body for 97382			
97384	2090	" " Cover for 97382			
192540	---	Screw Plug, complete, Nos. 192541 and 192542			
192541	2090	" " Base for 192540			
192542	2090	" " Cap with 192543 for 192540			
192543	2090	" " Flash Disc (fibre) for 192542			

SINGER LIGHT

(for details see Form K5550, List of Parts for B.R.K. Motors)

No.	Plate
193294	SINGER Light (moulded, less lamp), complete, Nos. 691j, 97359, 191785, 193248, 193289, 193400, 193421, 193431, 193437, 701842 and two 191786
194120	SINGER Light Lamp
<i>NOTE.—When ordering lamps for SINGER Lights, it is necessary to state the exact voltage required.</i>	
Example :—	194120, 240 volts

Bobbin Winder

for Hand Wheel No. 15282 or No. 32672

No.	Plate
15072	1954 Bobbin Position Pin
†125324	1955 Bracket (belt cover)
158e	1957 " Screw (2)
66670	1955 Frame
125366	" 66670 with 15288 and 125068
51319b	1955 " Hinge Screw
66601	1955 " Spring
15287	1955 Friction Ring (rubber)
15288	1955 Pulley
125068	1955 Spindle with 15072
2007	1954 Spool Pin
125376	1955 Stop Latch
51303b	1955 " " Hinge Screw
125462	1955 " " Spring
125395	1955 Tension Bracket
125396	" " complete, Nos. 45847, 45915, 45916, 125395 and 140138b
193b	1957 " " Screw
7071	1955 " " Washer
45915	1955 " Disc
45916	1955 " " Screw Washer
45847	1955 " " Spring
140138b	1955 " " Screw
125326	1955 Tripping Arm
190b	1957 " " Screw
†125327	1955 Bobbin Winder (automatic), complete, Nos. 190b, 15287, 51303b, 51319b, 66601, 125324, 125326, 125366, 125376 and 125462

† In ordering it is necessary to state Class of Machine.

Bobbin Winder Parts

for No. 15K91 Machine
(OBSOLETE)

No.	Plate							
15072	1954	Bobbin Position Pin
66670	1955	Frame
125366	---	"	66670 with 15288 and 125068
51319b	1955	"	Hinge Screw
125365	2091	"	Spring
15287	1955	Friction Ring	(rubber)
15288	1955	Pulley
125068	1955	Spindle with 15072
2007	1954	Spool Pin
125376	1955	Stop Latch
51303b	1955	"	" Hinge Screw
125462	1955	"	" Spring
125395	1955	Tension Bracket
125396	---	"	" complete, Nos. 45847, 45915, 45916, 125395 and 140138b
193b	1957	"	" Screw
7071	1955	"	" " Washer
45915	1955	"	Disc
45916	1955	"	" Screw Washer
45847	1955	"	" Spring
140138b	1955	"	Screw
125326	1955	Tripping Arm
190b	1957	"	" Screw

Attachments

Attachment Set
Supplied with Machine

No.	Plate							
121464	2574	Binder
36865	2574	Edge Stitcher
121441	2574	Gathering Foot (double toe)
35931	2574	Hemmer (adjustable)
15 × 1	---	Needles (6)
86642	2574	Ruffler
25537	2574	Screw Driver (machine)
120378	2574	"	" (bobbin case)
8879	2574	Spool Pin Washer (cloth)
160810	---	Set of Attachments, complete, Nos. 25537, 35931, 36865, 86642, 120378, 121441, 121464, two 8879 and six needles
160811	---	Set of Attachments (less needles), complete, Nos. 25537, 35931, 36865, 86642, 120378, 121441, 121464 and two 8879
120855	1946	Hemmer (foot) $\frac{5}{64}$ " hem
2518	1954	Shuttle Bobbin (4)
120861	---	Tin of Oil (3 oz.)

The following Attachments may be purchased at an additional charge:

25525	2719	Bias Gauge
25527b	2719	Cloth Guide
50053b	2719	" " and Underbraider Thumb Screw
120914	1946	Feller (foot)
120687	---	Imitation Hemstitching Attachment with Yielding Presser Plate
35932	2719	Quilter
121170	909	Ruffler Shirring Plate
25539	2719	Stiletto
36583	1956	Tucker
121547	909	Underbraider

Art Work and Darning

No.	Plate	
85893	1956	Embroidery Foot (for art work)
121094	2719	Darning Foot (spring)

Cording Feet

For Stitching on Edge and Inserting Cord

No.	Plate	
160845	2719	Presser Foot (left toe)
160846	2719	" " (right toe)

Imitation Hemstitching Attachment

No.	Plate	
120687	1956	with Yielding Presser Plate

Presser Feet

No.	Plate	
121875	—	Presser Foot, for 121877 <i>obsolete</i>
140347w	—	" " Adjusting Thumb Screw, for 121877 <i>obsolete</i>
121876	—	" " Body, for 121877 <i>obsolete</i>
121877	2719	Presser Foot (adjustable for sewing on the right or left side of the needle), complete, Nos. 121875, 121876 and 140347w, for Cording and Slide Fastener Work <i>obsolete, use 161127</i>
121441	2574	Presser Foot (double toe) for gathering

Presser Foot

(for Cording and Slide Fastener Work)

No.	Plate	
140728	—	Presser Foot Adjusting Thumb Screw
161122	—	" " " " " Spring
161123	—	" " Hinge Pin
161124	—	" " Plate
161125	—	" " Shank (adjustable)
161126	—	" " (stationary)
161127	—	Presser Foot (hinged, adjustable) for sewing on the right or left side of the needle, complete, Nos. 140728 and 161122 to 161126

96417	—	Round, 5 $\frac{3}{8}$ " diam. \times 7 $\frac{m}{m}$ high, complete, Nos. 101348 and 101349
96418	2193	" 7" " \times 7 $\frac{m}{m}$ " " Nos. 101350 and 101351
96419	—	" 8" " \times 7 $\frac{m}{m}$ " " Nos. 101352 and 101353
96420	—	" 10" " \times 7 $\frac{m}{m}$ " " Nos. 101354 and 101355
96421	—	" 12" " \times 7 $\frac{m}{m}$ " " Nos. 101356 and 101357
96423	—	Oval, 9" \times 4 $\frac{1}{2}$ " \times 7 $\frac{m}{m}$ high, complete, Nos. 101360 and 101361
96424	—	" 12" \times 5 $\frac{1}{2}$ " \times 7 $\frac{m}{m}$ " " Nos. 101362 and 101363

Embroidery Hoops (Plain)

(BIRCH)

No.	Plate	
87586	—	Round, 5 $\frac{3}{8}$ " diam. \times 7 $\frac{m}{m}$ high
96416	—	" 7" " \times 7 $\frac{m}{m}$ " "
87589	1221	" 8" " \times 7 $\frac{m}{m}$ " "
87593	—	" 10" " \times 7 $\frac{m}{m}$ " "
87595	—	" 12" " \times 7 $\frac{m}{m}$ " "
96422	1221	Oval, 9" \times 4 $\frac{1}{2}$ " \times 7 $\frac{m}{m}$ high
87597	—	" 12" \times 5 $\frac{1}{2}$ " \times 7 $\frac{m}{m}$ " "

Handwritten notes:
 101336 & 101337
 101346 & 101347
 101338 & 101339
 101340 & 101341
 101342 & 101343
 101358 & 101359
 101344 & 101345

Embroidery Hoops (with Clamp)

(BIRCH)

No.	Plate	
96417	—	Round, 5 $\frac{3}{8}$ " diam. \times 7 $\frac{m}{m}$ high, with SS528j, NN95j, two	96425	and four	96427	
96418	—	" 7" " \times 7 $\frac{m}{m}$ " " SS528j, NN95j, two	96426	and four	96427	
96419	—	" 8" " \times 7 $\frac{m}{m}$ " " SS528j, NN95j, two	96426	and four	96427	
96420	—	" 10" " \times 7 $\frac{m}{m}$ " " SS528j, NN95j, two	96426	and four	96427	
96421	—	" 12" " \times 7 $\frac{m}{m}$ " " SS528j, NN95j, two	96844	and four	96845	
96423	—	Oval, 9" \times 4 $\frac{1}{2}$ " \times 7 $\frac{m}{m}$ high, with SS528j, NN95j,	96425, 96426	and	96427	
96424	—	" 12" \times 5 $\frac{1}{2}$ " \times 7 $\frac{m}{m}$ " " SS528j, NN95j,	96425, 96426	and	96427	
96425	2399	Clamping Bracket for	96417, 96423 and 96424 101349, 101361 & 101363			
96426	2399	" " " "	96418 to 96420, 96423 and 96424 101351, 101353			
96844	2399	" " " "	96421 101357, 101355, 101361, 101363			
96427	2399	" " Rivet for	96417 to 96420, 96423 and 96424 101349,			
96845	2399	" " " "	96421 101351, 101353, 101355,			
SS528j	2399	" " Screw	101361 & 101362			
NN95j	2399	" " Nut

101336	---	"	"	(outer) for 87586
101337	---	"	"	(inner) for 87589
101338	---	"	"	(outer) for 87589
101339	---	"	"	(inner) for 87593
101340	---	"	"	(outer) for 87593
101341	---	"	"	(inner) for 87595
101342	---	"	"	(outer) for 87595
101343	---	"	"	(inner) for 87597
101344	---	"	"	(outer) for 87597
101345	---	"	"	(inner) for 96416
101346	---	"	"	(outer) for 96416
101347	---	"	"	(inner) for 96422
101358	---	"	"	(outer) for 96422
101359	---	"	"	(outer) for 96422

101348	---	Embroidery Hoop	(inner) for 96417
101349	---	"	(outer) with SS528j, NN95j, two 96425 and four 96427, for 96417
101350	---	"	(inner) for 96418
101351	---	"	(outer) with SS528j, NN95j, two 96426 and four 96427, for 96418
101352	---	"	(inner) for 96419
101353	---	"	(outer) with SS528j, NN95j, two 96426 and four 96427, for 96419
101354	---	"	(inner) for 96420
101355	---	"	(outer) with SS528j, NN95j, two 96426 and four 96427, for 96420
101356	---	"	(inner) for 96421
101357	---	"	(outer) with SS528j, NN95j, two 96844 and four 96845, for 96421
101360	---	"	(inner) for 96423
101361	---	"	(outer) with SS528j, NN95j, 96425, 96426 and four 96427, for 96423
101362	---	"	(inner) for 96424
101363	---	"	(outer) with SS528j, NN 95j, 96425, 96426 and four 96427, for 96424

Embroidery Hoop (with Spring)

(BIRCH)

No.	Plate	
101364	---	Hoop (inner) for 101246
101365	---	" (outer) with Spring, for 101246
101246	---	" (round) 10" diam. x $\frac{7}{16}$ " high, complete, Nos. 101364 and 101365

Hand Attachment

No.	Plate		No.	Plate
94050	2284	Body	25361	1950
94027	2284	" Bracket	25347	1950
183e	2114	" " Screw	25362	---
94028	2114	Crank Handle (wood)		
94029b	2114	" " Spindle	25267	---
94030b	2114	" " " Flange (loose)		
94069	2114	" Hinge Pin		
94031a	2284	" Lever	25268	1950
94032	2114	" " Lock Pin	25341	---
94033b	2114	" " " " Head		
55531	2114	" " " " Spring		
94034b	---	Crank , complete, Nos. 94028, 94029b, 94030b and 94031a	5269	1950
94046	2114	Driver	5345	---
94070	---	" 94046 with 80028 and 94048	1735j	1958
94036	2114	" Finger		
94039	2114	" " Driving Pad (raw-hide)	5374	---
94040	2114	" " " " Plate	5307	1950
SS567e	2114	" " " " and Plate Binding Screw	5379	---
94041	---	" " 94036 with SS567e, 94039 and 94040	5308	1950
94044	2114	" " Hinge Pin	335b	1957
94037	2114	" " Latch	714b	1958
SS565e	2114	" " " Screw Stud	5309	---
94038	2114	" " " Spring	8391	1950
94051b	2284	Gear with 55531, 94032 and 94033b		
94016	2284	" Cover		
399a	2114	" " Screw		
SS599f	2114	" Screw Stud		
94048	2114	Pinion		
80028	2114	" Dowel Pin		
SS600f	2114	" Screw Stud (eccentric)		
94052b	2284	Hand Attachment , complete, Nos. SS565e, SS566c, SS599f, SS600f, 94016, 94027, 94034b, 94037, 94038, 94041, 94044, 94050, 94051b, 94069, 94070, two each 183e and 399a		
SS566c	2114	Hand Attachment Screw		

Obsolete Parts

No.	Plate		No.	Plate
		Feed Bar Throw-out Lever with 1813		
		Feed Lifting Rock Shaft Crank with 157j		
		Feed Lifting Rock Shaft Crank, complete, Nos. 51289j, 125347 and 125361		
		Feed Lifting Rock Shaft, complete, Nos. 125263, 125349 and 125362		
		Feed Regulator		
		" " 125268 with 125345		
		Feed Reversing Lever		
		" " " 125269 with 1735j		
		" " " Lock Nut		
		Stitch Indicator Plate		
		" " " 125374 with 125309		
		" " " 125307 with 714b, 38391 and 125308		
		" " " Cover		
		" " " Screw (2)		
		" Regulating Thumb Screw		
		" " " " Bushing		
		" " " " Washer		

Numerical List of Parts

No.	Plate	
NN95j	2399	Embroidery Hoop Clamping Bracket Screw Nut for 96417 to 96421, 96423 and 96424 101353, 101355,
138e	1957	Arm Screw 101357, 101361, 101363.
145j	1957	Shuttle Race Screw
157j	1957	Feed Lifting Rock Shaft Crank Clamping Screw for 125347 and 125388
158e	1957	Bobbin Winder Bracket Screw
175j	1957	Feed Forked Connection Adjusting Screw for 125262
183e	2114	Hand Attachment Body Bracket Screw for 94052b
190b	1957	Bobbin Winder Tripping Arm Screw for 125327 and 193644
190b	1957	Face Plate Screw
193b	1957	Bobbin Winder Tension Bracket Screw
208al	1957	Feed Dog Screw
224b	4959	Motor Cover Screw for 15K91 Machine
246a	2091	Clamp Stop Motion Clamp Stop Screw for 15K91 Machine
248a	1957	Clamp Stop Motion Clamp Stop Screw for 15314
256b	1957	Clamp Stop Motion Clamp Screw for 15314
304c	1957	Feed Lifting Rock Shaft Screw Centre for 125344
304c	1957	Feed Rock Shaft Screw Centre for 125344
315c	1957	Feed Bar Screw Centre
335b	1957	Stitch Indicator Plate Cover Screw (Obsolete)
335b	1957	Stitch Indicator Plate Screw
375c	1957	Crank Connecting Rod Hinge Screw
391j	1957	Shuttle Bobbin Case Position Plate Screw for 125300
399a	2114	Hand Attachment Gear Cover Screw for 94052b
435c	1957	Arm Shaft Bushing Set Screw for 125252
447c	4959	Armature Shaft Bearing Sleeve (commutator end) Set Screw for 193545
447c	4959	Armature Shaft Bearing Sleeve (front end) Set Screw for 193545
448c	1957	Presser Bar Lifter Hinge Stud Set Screw for 125252
453c	1957	Presser Bar Spring Bracket Set Screw for 2068
462al	1957	Armature Shaft Pinion Set Screw for 193529
462al	1957	Clamp Stop Motion Flanged Bushing Set Screw for 15313 and 125372

No.	Plate	
462al	1957	Oscillating Shaft Crank Set Screw for 125283 and 125284
SS528j	2399	Embroidery Hoop Clamping Bracket Screw for 96417 to 96421, 96423 and 96424 10134410
SS565e	2114	Hand Attachment Driver Finger Latch Screw Stud for 94052b 101353, 101357, 1013
SS566c	2114	Hand Attachment Screw for 94052b
SS567e	2114	Hand Attachment Driver Finger Driving Pad and Plate Binding Screw for 94041 ...
570c	1957	Needle Bar Connecting Link Hinge Screw for 15434
591f	1957	Shuttle Tension Regulating Screw for 125291
592e	1957	Shuttle Bobbin Case Latch Stop Screw for 125291
SS599f	2114	Hand Attachment Gear Screw Stud for 94052b
SS600f	2114	Hand Attachment Pinion Screw Stud (eccentric) for 94052b
662j	1957	Shuttle Race Cap Screw for 125304 ...
691a	1957	Throat Plate Screw
714b	1958	Stitch Regulating Thumb Screw for 125379 (Obsolete)
857b	1957	Thread Take-up Spring Regulator Set Screw for 125368
882e	4959	Brush Tube Insulating Bushing Set Screw for 193545
896e	1957	Crank Connecting Rod Cap Screw for 125021
1085e	1957	Feed Forked Connection Slide Block Screw Stud for 125335
1253c	1957	Shuttle Driver Set Screw for 125297 ...
1285c	1957	Feed Cam and Counterbalance Position Screw for 125045
1293al	1957	Thread Take-up Cam Timing Screw for 15272
1341c	1958	Needle Bar Connecting Stud Set Screw for 125276
1498c	1958	Needle Bar Bushing Set Screw
1513j	1958	Feed Lifting Rock Shaft Screw Centre Nut for 125344
1513j	1958	Feed Rock Shaft Screw Centre Nut for 125344
1518j	1958	Crank Connecting Rod Hinge Screw Nut ...
1519j	1958	Feed Bar Screw Centre Nut
1520j	1958	Feed Forked Connection Hinge Screw Nut
1520j	1958	Needle Bar Connecting Link Hinge Screw Nut for 15434
1550j	1960	Feed Reversing Handle Lock Nut for 125381
1735j	1958	Feed Reversing Lever Lock Nut for 125345 (Obsolete)

No.	Plate	
1768r	4959	Three-Pin Terminal (female half) Housing Screw Nut for 192989
1813	1958	Feed Throw-out Lever Roller and Stud for 125361 and 125386
1822	1958	Thread Take-up Lever Roller and Stud for 125382
2002	1954	Arm Dowel Pin
2007	1954	Arm Spool Pin
2007	1954	Bobbin Winder Spool Pin
2020	1954	Clamp Stop Motion Clamp Washer for 15314
2022	2552	Clamp Stop Motion Flanged Bushing Pin ...
2049	2552	Oscillating Shaft Crank Pin for 125363 ...
2049	2552	Shuttle Driver Pin
2068	2552	Presser Bar Spring Bracket with 453c ...
2070	2552	Presser Bar Spring Washer
2102	2552	Tension Disc for 125418
2518	1954	Shuttle Bobbin for 125294
2835	792	Feed Bar
2974	1954	Shuttle Bobbin Case Latch Lever Fulcrum Pin for 125288
2975	1954	Shuttle Bobbin Case Latch Spring for 125291
7071	1955	Bobbin Winder Tension Bracket Screw Washer
8879	2574	Spool Pin Washer (cloth) for 160810 and 160811
15072	1954	Bobbin Winder Bobbin Position Pin for 125068
*15170	2552	Oscillating Shaft Crank Slide Block for 125330
*15248	1954	Needle Bar Connecting Link with 51002e, for 125275
15272	1954	Thread Take-up Cam with 1293al, for 15434
15282	1152	Hand Wheel, 2 1/4" pulley, for 15K88 and 15K89 Machines
15287	1955	Bobbin Winder Friction Ring (rubber) for 125327 and 15K91 Machine
15288	1955	Bobbin Winder Pulley for 125366
*15312	---	Clamp Stop Motion Flanged Bushing for 15313
15313	1954	Clamp Stop Motion Flanged Bushing 15312 with two 462al, for 15314
15314	---	Clamp Stop Motion, complete, Nos. 248a, 256b, 2020 and 15313, for 15K88 to 15K90 Machines
15410	2552	Tension Stud Bushing for 125384
*15434	---	Thread Take-up Cam 15272, with 570c and 1520j, for 125254

No.	Plate	
15486	2552	Presser Bar Lifter Hinge Stud for 125252 ...
15498	1954	Arm Shaft Bushing for 125252 and 125254
25525	2719	Bias Gauge
25527b	2719	Cloth Guide
25537	2574	Screw Driver (machine) for 160810 and 160811 (Accessories)
25539	2719	Stiletto
26075	2552	Thread Cutter and Holder
32519	1954	Needle Stop Pin for 125377
32672	1722	Hand Wheel, 3 1/2" Pulley, for 15K90 Machine
*32774	-	Presser Foot Shank for 45321
35931	2574	Hemmer (adjustable) for 160810 and 160811
35932	2719	Quilter
36583	1956	Tucker
36865	2574	Edge Stitcher for 160810 and 160811
38391	1950	Stitch Regulating Thumb Screw Washer for 125379 (Obsolete)
45285	1951	Needle Clamp 45334 with 51308j
45290	-	Stitch Regulating Thumb Screw Bushing for 45308
45305	1960	Feed Reversing Handle for 125381
45306	1960	Stitch Indicator Plate for 45309
45307	-	Stitch Regulating Plate for 45308
45308	1960	Stitch Regulating Plate 45307 with 45289 for 45309
45309	-	Stitch Regulating Plate 45308 with 45306, 45310, 51312b and 125400
45310	1960	Stitch Regulating Thumb Screw Washer (fibre) for 45309
45319	-	Presser Foot Plate for 45321
45321	1951	Presser Foot (hinged), complete, Nos. 32774, 45319, and 45329
45329	-	Presser Foot Hinge Pin for 45321
45334	-	Needle Clamp with 140545c for 45285
45339	2391	Tension Regulating Thumb Nut Engaging Pin for 51682
45847	1955	Bobbin Winder Tension Disc Spring for 125396
45865	2391	Tension Indicator Flange Stop Washer for 125418
45915	1955	Bobbin Winder Tension Disc for 125396
45916	1955	Bobbin Winder Tension Disc Screw Washer for 125396
50053b	2719	Cloth Guide and Under Braider Thumb Screw
50292b	1957	Tension Stud Set Screw for 125368
50353e	1957	Feed Regulator Hinge Screw

No.	Plate	
50527c	1957	Thread Take-up Lever Hinge Screw for 125383
50617b	4959	Armature Shaft Bearing Sleeve (front end) Cap Screw for 15K91 Machine
50657r	4964	Three-Pin Terminal Body (male half) Screw for 15K91 Machine
51002c	1957	Needle Bar Connecting Link Adjusting Screw for 15248
51045c	1958	Machine Hinge Connection Set Screw
51093r	2091	Three-Pin Terminal (female half) Housing Screw for 192989
51224b	1957	Arm Side Cover Thumb Screw
51224b	1957	Presser Foot Thumb Screw
*51228b	2552	Pressure Regulating Thumb Screw for 66773
51229c	1958	Shuttle Driver Cushion Spring Screw for 125322 and 125323
51246c	1958	Oscillating Rock Shaft Centre (left) Set Screw
51246c	1958	Oscillating Rock Shaft Centre (right) Set Screw
51252c	1958	Feed Forked Connection Hinge Screw (eccentric)
51261j	1958	Shuttle Race Back Spring Thumb Screw for 125306
51280b	2091	Clamp Stop Motion Clamp Screw for 125371
51281c	4956	Hand Wheel Gear Collar Set Screw for 125353
51282j	1958	Shuttle Race Slide Spring Screw for 125338
51284r	4959	Grease Wick Spring Cap Screw for 15K91 Machine
51285e	4959	Motor Frame Screw for 15K91 Machine
51286r	4959	Field Core Screw for 15K91 Machine
51289j	1958	Feed Throw-out Lever Thumb Screw for 125362 and 125389
51293e	4964	Three-Pin Terminal Body (male half) Bracket Screw for 15K91 Machine
51303b	1955	Bobbin Winder Stop Latch Hinge Screw for 125327 and 193644
51308j	1958	Needle Clamp Position Screw for 45285
51312b	1960	Stitch Regulating Thumb Screw for 45309
51319b	2091	Bobbin Winder Frame Hinge Screw for 125327 and 193644
51582b	2091	Three-Pin Terminal Body (male half) Post Thumb Nut for 192797
51682b	2391	Tension Regulating Thumb Nut with 45339 for 125420

No.	Plate	
55531	2114	Hand Attachment Crank Lever Lock Pin Spring for 94051b
55621	1951	Presser Bar Lifter
66601	1955	Bobbin Winder Frame Spring for 125327 ...
66670	1955	Bobbin Winder Frame for 125366 ...
66752	2552	Pressure Regulating Thumb Screw Plug (felt) for 66773
66773	---	Pressure Regulating Thumb Screw 51228b with 66752

No.	Plate	
80011	2391	Presser Bar Spring
80028	2114	Hand Attachment Pinion Dowel Pin for 94070
85893	1956	Embroidery Foot (for art work)
86642	2574	Ruffler for 160810 and 160811
87586	---	Embroidery Hoop (round, birch) 5 $\frac{3}{8}$ " diam. $\times 7\frac{m}{m}$ high <i>10/336 & 10/337</i> ...
87589	1221	Embroidery Hoop (round, birch) 8" diam. $\times 7\frac{m}{m}$ high <i>10/338 & 10/339</i> ...
87593	---	Embroidery Hoop (round, birch) 10" diam. $\times 7\frac{m}{m}$ high <i>10/340 & 10/341</i> ...
87595	---	Embroidery Hoop (round, birch) 12" diam. $\times 7\frac{m}{m}$ high <i>10/342 & 10/343</i> ...
87597	---	Embroidery Hoop (oval, birch) 12" \times 5 $\frac{1}{2}$ " \times 7 $\frac{m}{m}$ high <i>10/344 & 10/345</i> ...

No.	Plate	
94016	2284	Hand Attachment Gear Cover for 94052b ...
94027	2284	Hand Attachment Body Bracket for 94052b
94028	2114	Hand Attachment Crank Handle (wood) for 94034b
94029b	2114	Hand Attachment Crank Handle Spindle for 94034b
94030b	2114	Hand Attachment Crank Handle Spindle Flange (loose) for 94034b
94031a	2284	Hand Attachment Crank Lever for 94034b ...
94032	2114	Hand Attachment Crank Lever Lock Pin for 94051b
94033b	2114	Hand Attachment Crank Lever Lock Pin Head for 94051b
94034b		Hand Attachment Crank, complete, Nos. 94028, 94029b, 94030b and 94031a, for 94052b
94036	2114	Hand Attachment Driver Finger for 94041
94037	2114	Hand Attachment Driver Finger Latch for 94052b
94038	2114	Hand Attachment Driver Finger Latch Spring for 94052b
94039	2114	Hand Attachment Driver Finger Driving Pad (raw-hide) for 94041
94040	2114	Hand Attachment Driver Finger Driving Pad Plate for 94041
94041		Hand Attachment Driver Finger 94036, with SS567c, 94039 and 94040, for 94052b ...
94044	2114	Hand Attachment Driver Finger Hinge Pin for 94052b
94046	2114	Hand Attachment Driver for 94070
94048	2114	Hand Attachment Pinion for 94070
94050	2284	Hand Attachment Body for 94052b
94051b	2284	Hand Attachment Gear with 55531, 94032 and 94033b, for 94052b
94052b	2284	Hand Attachment, complete Nos. SS565e, SS566c, SS599f, SS600f, 94016, 94027, 94034b, 94037, 94038, 94041, 94044, 94050, 94051b, 94069, 94070, two each 183c and 399a
94069	2114	Hand Attachment Crank Hinge Pin for 94052b
94070		Hand Attachment Driver 94046 with 80028 and 94048, for 94052b

No.	Plate	
96416		Embroidery Hoop (round, birch) 7" diam. × 7 ^m / _m high 101346 & 101347 ...
96417		Embroidery Hoop (round, birch) 5 ³ / ₈ " diam. × 7 ^m / _m high, with SS528j, NN95j, two 96425 and four 96427
96418		Embroidery Hoop (round, birch) 7" diam. × 7 ^m / _m high, with SS528j, NN95j, two 96426 and four 96427
96419		Embroidery Hoop (round, birch) 8" diam. × 7 ^m / _m high, with SS528j, NN95j, two 96426 and four 96427
96420		Embroidery Hoop (round, birch) 10" diam. × 7 ^m / ₁₆ " high, with SS528j, NN95j, two 96426 and four 96427
96421		Embroidery Hoop (round, birch) 12" diam. × 5 ³ / ₈ " high, with SS528j, NN95j, two 96844 and four 96845
96422	1221	Embroidery Hoop (oval, birch) 9" × 4 ¹ / ₂ " × 7 ^m / _m high 101358 & 101359
96423		Embroidery Hoop (oval, birch) 9" × 4 ¹ / ₂ " × 7 ^m / _m high, with SS528j, NN95j, 96425, 96426 and four 96427
96424		Embroidery Hoop (oval, birch) 12" × 5 ¹ / ₂ " × 7 ^m / _m high, with SS528j, NN95j, 96425, 96426 and four 96427
96425	2399	Embroidery Hoop Clamping Bracket for 101349, 101361, 101362 & 101363.
96426	2399	Embroidery Hoop Clamping Bracket for 101351, 101353, 101355, 101361, 101362, 101363
96427	2399	Embroidery Hoop Clamping Bracket Rivet for 96417 to 96420, 96423 and 96424 101349, 101351, 101353, 101355
96844	2399	Embroidery Hoop Clamping Bracket for 101353, 101355, 101361 & 101362
96845	2399	Embroidery Hoop Clamping Bracket Rivet for 96421 101357
97382	2090	Bayonet Plug, complete, Nos. 97383 and 97384, for 15K91 Machine
97383	2090	Bayonet Plug Body for 97382
97384	2090	Bayonet Plug Cover for 97382
96417		Embroidery Hoop (round, birch) 5 ³ / ₈ " diam. × 7 ^m / _m high, complete, Nos. 101348 and 101349
96418	2193	Embroidery Hoop (round, birch) 7" diam. × 7 ^m / _m high, complete, Nos. 101350 and 101351
96419		Embroidery Hoop (round, birch) 8" diam. × 7 ^m / _m high, complete, Nos. 101352 and 101353
96420		Embroidery Hoop (round, birch) 10" diam. × 7 ^m / ₁₆ " high, complete, Nos. 101354 and 101355
96421		Embroidery Hoop (round, birch) 12" diam. × 5 ³ / ₈ " high, complete, Nos. 101356 and 101357
96423		Embroidery Hoop (oval, birch) 9" × 4 ¹ / ₂ " × 7 ^m / _m high, complete, Nos. 101360 and 101361
96424		Embroidery Hoop (oval, birch) 12" × 5 ¹ / ₂ " × 7 ^m / _m high, complete, Nos. 101362 and 101363

101362	—	Embroidery Hoop (inner) for 96424	...
101363	—	Embroidery Hoop (outer) with SS528j, NN95j, 96425, 96426 and four 96427, for 96424	...
101364	—	Embroidery Hoop (inner) for 101246	...
101365	—	Embroidery Hoop (outer) with Spring, for 101246	...
140728	—	Presser Foot Adjusting Thumb Screw for 161127	...
101122	—	Presser Foot Adjusting Thumb Screw Spring for 161127	...
161123	—	Presser Foot Hinge Pin for 161127	...
161124	—	Presser Foot Plate for 161127	...
161125	—	Presser Foot Shank (adjustable) for 161127	...
161126	—	Presser Foot Shank (stationary) for 161127	...
161127	—	Presser Foot (hinged, adjustable) for sewing on the right or left side of the needle, complete, Nos. 140728 and 161122 to 161126	...
101246	—	Embroidery Hoop (round, birch) 10" diam. x $\frac{1}{8}$ " high, complete, Nos. 101364 and 101365	...
101336	—	Embroidery Hoop (inner) for 87586	...
101337	—	Embroidery Hoop (outer) for 87586	...
101338	—	Embroidery Hoop (inner) for 87589	...
101339	—	Embroidery Hoop (outer) for 87589	...
101340	—	Embroidery Hoop (inner) for 87593	...
101341	—	Embroidery Hoop (outer) for 87593	...
101342	—	Embroidery Hoop (inner) for 87595	...
101343	—	Embroidery Hoop (outer) for 87595	...
101344	—	Embroidery Hoop (inner) for 87597	...
101345	—	Embroidery Hoop (outer) for 87597	...
101346	—	Embroidery Hoop (inner) for 96416	...
101347	—	Embroidery Hoop (outer) for 96416	...
101348	—	Embroidery Hoop (inner) for 96417	...
101349	—	Embroidery Hoop (outer) with SS528j, NN95j, two 96425 and four 96427, for 96417	...
101350	—	Embroidery Hoop (inner) for 96418	...
101351	—	Embroidery Hoop (outer) with SS528j, NN95j, two 96426 and four 96427, for 96418	...
101352	—	Embroidery Hoop (inner) for 96419	...
101353	—	Embroidery Hoop (outer) with SS528j, NN95j, two 96426 and four 96427, for 96419	...
101354	—	Embroidery Hoop (inner) for 96420	...
101355	—	Embroidery Hoop (outer) with SS528j, NN95j, two 96426 and four 96427, for 96420	...
101356	—	Embroidery Hoop (inner) for 96421	...
101357	—	Embroidery Hoop (outer) with SS528j, NN95j, two 96844 and four 96845, for 96421	...
101358	—	Embroidery Hoop (inner) for 96422	...
101359	—	Embroidery Hoop (outer) for 96422	...
101360	—	Embroidery Hoop (inner) for 96423	...

No.	Plate	
120378	2574	Screw Driver (bobbin case) for 160810 and 160811
120687	1956	Imitation Hemstitching Attachment with yielding presser plate
120855	1946	Hemmer (foot), $\frac{5}{8}$ " hem...
120861		Tin of Oil (3 oz.)
120914	1946	Feller (foot)
121094	2719	Darning Foot (spring)
121170	909	Ruffler Shirring Plate
121441	2574	Gathering Foot (double toe) for 160810 and 160811
121441	2574	Presser Foot (double toe) for gathering
121461	2574	Binder for 160810 and 160811
121547	909	Under Braider
121875		Presser Foot for 121877 <i>obsolete</i>
121876		Presser Foot Body for 121877 <i>obsolete</i>
121877	2719	Presser Foot (adjustable for sewing on the right or left side of the needle), complete, Nos. 121875, 121876 and 140347w, for Cording and Slide Fastener Work <i>obsolete use 161127</i>
*125012		Crank Connecting Rod Cap for 125021
125021	1947	Crank Connecting Rod with 125012, 125044 and two 896e
125029		Drip Pan (for Cover Set)
125044	1949	Crank Connecting Rod Oil Pad (felt) for 125021
125045	2552	Feed Cam and Counterbalance with 1285c, for 125251
125047	2552	Feed Forked Connection Slide Block for 125335
125048	2552	Oscillating Rock Shaft Centre (left)
125049	2552	Oscillating Rock Shaft Centre (right)
125056	1949	Oscillating Rock Shaft Oil Wick (braided cotton) for 125280
*125060	2552	Oscillating Shaft Crank Slide Block Stud for 125330
125061	2552	Presser Bar
125068	1955	Bobbin Winder Spindle with 15072, for 125366
*125251		Arm for 125252
125252		Arm 125251 with 435e, 448c, 15486 and 15498
125253	1947	Arm Shaft for 125254
*125254		Arm Shaft 125253 with 15434, 15498 and 125045
*125255		Bed
125258	1951	Face Plate Tension Seat for 125384
125261	1946	Feed Dog, 12 teeth (14 teeth to the inch)

No.	Plate	
125262	1947	Feed Forked Connection with 175j, for 125340
125263	1947	Feed Lifting Rock Shaft for 125267 and 125390
125267	--	Feed Lifting Rock Shaft, complete, Nos. 125263, 125349 and 125362 (Obsolete)
125268	1950	Feed Regulator for 125341 (Obsolete)
125269	1950	Feed Reversing Lever for 125345 (Obsolete)
125270	1947	Feed Rock Shaft
*125272	1951	Needle Bar Bushing for 125273
125273	—	Needle Bar Bushing 125272 with 125274
125274	1949	Needle Bar Bushing Oil Pad (felt) for 125273
125275	—	Needle Bar Connecting Link 15248 with 125276
125276	1950	Needle Bar Connecting Stud with 1341c, for 125275
125280	1947	Oscillating Rock Shaft with 125056
125281	2551	Oscillating Shaft for 125363
*125282	—	Oscillating Shaft Crank for 125283 and 125284
*125283	1950	Oscillating Shaft Crank 125282, with 462al and 125330 for 125323
125284	—	Oscillating Shaft Crank 125282 with 125330 and two 462al
125285	1946	Presser Foot
125287	1949	Shuttle Bobbin Case Latch for 125288
125288	—	Shuttle Bobbin Case Hinge, Nos. 2974, 125287 and 125320 for 125291
125290	1948	Shuttle Bobbin Case Position Plate for 125300
125291	1949	Shuttle Bobbin Case with 591f, 592c, 2975, 125288 and 125293, for 125294
125292	1949	Shuttle Body for 125294
125293	1949	Shuttle Tension Spring for 125291
125294	—	Shuttle, 1 $\frac{1}{8}$ " diam., complete, Nos. 2518, 125291 and 125292
*125295	1949	Shuttle Driver for 125297 and 125363
125297	—	Shuttle Driver 125295, with two 1253c, for 125322
125298	1949	Shuttle Driver Cushion Spring for 125322 and 125323
125299	1948	Shuttle Race Back for 125306
125300	—	Shuttle Race Body 125304, with 125290, two each 391j and 125301, for 125306
125301	1949	Shuttle Race Back Position Pin for 125300
125302	1948	Shuttle Race Back Spring for 125306
125303	1948	Shuttle Race Body for 125304
125304	—	Shuttle Race Body 125303 with 125305 and two 662j, for 125300

No.	Plate	
125305	1948	Shuttle Race Cap for 125304
125306	—	Shuttle Race, complete, Nos. 51261j, 125299, 125300 and 125302
125307	1950	Stitch Indicator Plate 125374, with 125309, for 125379 (Obsolete)
125308	1950	Stitch Indicator Plate Cover for 125379 (Obsolete)
*125309	—	Stitch Regulating Thumb Screw Bushing for 125307 (Obsolete)
125311	2391	Tension Spring for 125418
125316	2391	Thread Take-up Spring for 125418
125317	1951	Thread Take-up Spring Regulator for 125368
125319	1946	Throat Plate for 125261
125320	1949	Shuttle Bobbin Case Latch Lever for 125288
125322	1949	Shuttle Driver 125297 with 125298 and two 51229e
125323	—	Oscillating Shaft 125363 with 125283, 125298 and two 51229e
†125324	1955	Bobbin Winder Bracket (belt cover) for 125327
125326	1955	Bobbin Winder Tripping Arm for 125327 and 193644
†125327	1955	Bobbin Winder (automatic), complete, Nos. 190b, 15287, 51303b, 51319b, 66601, 125324, 125326, 125366, 125376 and 125462 for Hand Wheel No. 15282 or No. 32672
125330	—	Oscillating Shaft Crank Slide Block 15170, with 125060, for 125283 and 125284
125331	1949	Arm Oil Pad (felt) for oiling Arm Shaft Back Bearing
125333	1949	Arm Oil Pad Spring
125334	1949	Arm Oil Pad Spring Cap
125335	—	Feed Forked Connection Slide Block 125047 with 1085e, for 125340
125336	1946	Shuttle Race Slide for 125338
125337	1946	Shuttle Race Slide Spring for 125338
125338	—	Shuttle Race Slide, complete, Nos. 125336, 125337 and two 51282j
† In ordering it is necessary to state Class of Machine.		
125340	—	Feed Forked Connection 125262 with 125335
125341	—	Feed Regulator 125268 with 125345 (Obsolete)
125344	—	Feed Lifting Rock Shaft Screw Centre 304c with 1513j
125344	—	Feed Rock Shaft Screw Centre 304c with 1513j

No.	Plate	
125345	--	Feed Reversing Lever 125269, with 1735j, for 125341 (Obsolete)
125347	1950	Feed Lifting Rock Shaft Crank with 157j, for 125362 (Obsolete)
125349	1950	Feed Throw-out Lever Retaining Ring for 125267 and 125390
125350	4960	Hand Wheel with 125358, for 125364
125351	---	Hand Wheel Gear (textolite) for 125352
125352	4956	Hand Wheel Gear 125351, with 125356 and 125357, for 125364
125353	4956	Hand Wheel Gear Collar with three 51281c, for 125364
125354	4956	Hand Wheel Gear Spring for 125364
125355	4956	Hand Wheel Gear Spring Retaining Washer for 125364
125356	4956	Hand Wheel Gear Spring Stud for 125352
125357	4956	Hand Wheel Gear Spring Stud Washer for 125352
125358	4956	Hand Wheel Spring Stud for 125350
125359	2091	Clamp Stop Motion Clamp Washer for 15K91 Machine
125360	1949	Clamp Stop Motion Flanged Bushing for 125371 and 125372
125361	1950	Feed Bar Throw-out Lever with 1813, for 125362 (Obsolete)
125362	---	Feed Lifting Rock Shaft Crank, complete, Nos. 51289j, 125347 and 125361, for 125267 (Obsolete)
125363	---	Oscillating Shaft 125281 with 2049 and 125295 for 125323
125364	---	Hand Wheel 125350 with 125352 to 125355 and two 125385 for 15K91 Machine
125365	2091	Bobbin Winder Frame Spring for 193644
125366	---	Bobbin Winder Frame 66670, with 15288 and 125068 for 125327 and 193644
*125367	2551	Face Plate for 125384
125368	---	Face Plate 125381, with 857b, 50292b and 125317, for 125412
125369	1950	Face Plate Thread Guard 125428 with 125373, for 125384
*125371	---	Clamp Stop Motion Flanged Bushing 125360 with 51280b, for 15K91 Machine
125372	---	Clamp Stop Motion Flanged Bushing 125360 with two 462a1, for 15K91 Machine
125373	---	Face Plate Thread Guard Rivet for 125369
125374	---	Stitch Indicator Plate for 125307 (Obsolete)

No.	Plate	
125376	1955	Bobbin Winder Stop Latch for 125327 and 193644
125377	1951	Needle Bar with 32510
125378	1951	Needle Clamp Gib and Thread Guard
125379	---	Stitch Indicator Plate 125307 with 714b, 38391 and 125308 (Obsolete)
125381	---	Feed Reversing Handle 45305 with 1550j, for 125398
*125382	1951	Thread Take-up Lever with 1822, for 125383
125383	---	Thread Take-up Lever 125382 with 50527c
125384	---	Face Plate 125367, with 15410, 125258 and 125369, for 125368
125385	2091	Hand Wheel Gear Spring Cushion Pin (eccentric) for 125364
125386	1960	Feed Throw-out Lever with 1813, for 125389
125387	1960	Feed Throw-out Lever Spring for 125389
125388	1960	Feed Lifting Rock Shaft Crank with 157j, for 125389
125389	---	Feed Lifting Rock Shaft Crank, complete, Nos. 51289j and 125386 to 125388, for 125390
125390	---	Feed Lifting Rock Shaft, complete, Nos. 125263, 125349 and 125389
125395	1955	Bobbin Winder Tension Bracket for 125396
125396	---	Bobbin Winder Tension Bracket, complete, Nos. 45847, 45915, 45916, 125395 and 140138b
125397	2391	Feed Regulator for 125398
125398	---	Feed Regulator 125397 with 125381
125399	2552	Feed Regulator Hinge Screw Friction Washer
125400	2391	Stitch Regulating Thumb Screw Friction Washer for 45309
125412	2551	Face Plate 125368 with 125418
125416	2391	Tension Indicator Flange for 125418
125417	2391	Tension Releasing Pin for 125418
125418	---	Tension, complete, Nos. 45865, 125314, 125316, 125416, 125417, 125419 to 125421 and two 2102 for 125412
125419	2391	Thread Take-up Spring Thread Guard for 125418
125420	---	Tension Stud 140175e with 51682b for 125418
125421	2391	Tension Indicator for 125418
125425b	2391	Arm Side Cover
125428	2391	Face Plate Thread Guard for 125369

No.	Plate	
125462	1955	Bobbin Winder Stop Latch Spring for 125327 and 193644

No.	Plate	
140138b	1955	Bobbin Winder Tension Screw for 125396 ...
140175c	2391	Tension Stud for 125420 ...
140347w	2719	Presser Foot Adjusting Thumb Screw for 121877 <i>absolute</i> ...
140545c	1958	Needle Clamp Thumb Screw for 45334 ...
160810	---	Set of Attachments, complete, Nos. 25537, 35931, 36865, 86642, 120378, 121441, 121464, two 8879 and six needles ...
160811	---	Set of Attachments (less needles), complete, Nos. 25537, 35931, 36865, 86642, 120378, 121441, 121464 and two 8879 ...
160845	2719	Cording Foot (left toe) for Stitching on Edge, Inserting Cord and Slide Fastener Work
160846	2719	Cording Foot (right toe) for Stitching on Edge, Inserting Cord and Slide Fastener Work

No.	Plate	
190439	—	Tube, filled with Singer Lubricant, for Electric Motors, for 190613
190612	—	Tube Carton (paper) for 190613
190613	—	Tube 190439 with 190612, for 15K91 Machine
192348	1949	Lead Bushing for 192875
192424	4959	Field Coil Retainer for 15K91 Machine ...
192457	4959	Brush (carbon) for 50 to 145 volts, for 15K91 Machine
192458	4959	Brush Spring for 15K91 Machine
192540	—	Screw Plug, complete, Nos. 192541 and 192542, for 15K91 Machine
192541	2090	Screw Plug Base for 192540
192542	2090	Screw Plug with 192543, for 192540
192543	2090	Screw Plug Flash Disc (fibre) for 192542 ...
*192642	—	Three-Pin Terminal Body (male half) for 193700
*192643	—	Three-Pin Terminal (female half) Housing (upper) for 192989
*192644	—	Three-Pin Terminal (female half) Housing (lower) for 192989
192691	2091	Three-Pin Terminal (female half) Insert Sleeve for 192989
192692	2091	Three-Pin Terminal (female half) Insert Clamp for 192989
192790	4959	Three-Pin Terminal Adaptor Bushing for 192851
192793	2091	Three-Pin Terminal Body (male half) Post for 193700
192797	4964	Three-Pin Terminal Body (male half), complete, Nos. 193700, three each 51582 and 701719, for 15K91 Machine
*192820	—	Lead Cord, 8 ft. long, for 192875
192851	—	Lead Cord, complete, from lamp socket to three-pin terminal, for Knee and Treadle Control, Nos. 192790, 192852, 192989 and Plug for 15K91 Machine
*192852	—	Lead Cord for 192851
192874	—	Lead Cord, 3 ft. 10 ins. long, for 192875 ...
192875	—	Lead Cord, complete, from lamp socket to three-pin terminal and controller, for Foot Controller, Nos. 192348, 192820, 192874, 192989, Plug and two 195834, for 15K91 Machine

No.	Plate	
192989	4964	Three-Pin Terminal (female half), complete, Nos. 192643, 192644, two each 1768r, 51093r, three each 192691 and 192692, for 192851 and 192875
193294	—	SINGER Light (moulded, less lamp), complete, Nos. 691j, 97359, 191785, 193248, 193289, 193400, 193421, 193431, 193437, 701842, and two 191786
193522	—	Motor Frame for 193545
193523	4959	Armature Shaft Bearing Sleeve (commutator end) for 193545
193524	4959	Armature Shaft Bearing Sleeve (front end) for 193545
193525	—	Grease Wick 193526 with 193527, for 15K91 Machine
193526	4959	Grease Wick for 193525
193527	4959	Grease Wick Spring for 193525
*193528	—	Armature Shaft for 15K91 Machine
193529	4959	Armature Shaft Pinion (spiral) with two 462al, for 15K91 Machine
193536	4960	Commutator, complete, for 15K91 Machine
*193540	—	Armature Core, complete, for 15K91 Machine
193541	4960	Field Core, complete, for 15K91 Machine ...
193542	4959	Armature Shaft Oil Sling for 15K91 Machine
193543	4959	Brush Cap for 15K91 Machine
193544	4960	Motor Cover for 15K91 Machine
193545	4960	Motor Frame 193522 with 193523, 193524, two each 447c and 882e, for 193644
193546	4959	Brush Tube Insulating Bushing for 15K91 Machine
193555	4960	Armature, complete, for P.G.K. 3 Motor for 15K91 Machine
193556	—	Armature, complete, for P.G.K. 5 Motor for 15K91 Machine
193557	—	Armature, complete, for P.G.K. 6 and P.G.K. 7 Motors for 15K91 Machine
193558	—	Armature, complete, for P.G.K. 8 Motor for 15K91 Machine
193559	—	Armature, complete, for P.G.K. 9 Motor for 15K91 Machine
193560	—	Armature, complete, for P.G.K. 10 and P.G.K. 92 Motors for 15K91 Machine ...
193561	2090	Armature, complete, for P.G.K. 11 and P.G.K. 12 Motors for 15K91 Machine
193562	—	Armature, complete, for P.G.K. 15 Motor for 15K91 Machine

No.	Plate	
193563	—	Armature, complete, for P.G.K. 87 Motor for 15K91 Machine
193564	—	Armature, complete, for P.G.K. 90 Motor for 15K91 Machine
193565	—	Field Coil, complete, Nos. 193566 and 193567, for P.G.K. 3 Motor for 15K91 Machine ...
193566	—	Field Coil (left) for 193565
193567	—	Field Coil (right) for 193565
193568	—	Field Coil, complete, Nos. 193569 and 193570, for P.G.K. 5 Motor for 15K91 Machine ...
193569	—	Field Coil (left) for 193568
193570	—	Field Coil (right) for 193568
193571	—	Field Coil, complete, Nos. 193572 and 193573, for P.G.K. 6 Motor for 15K91 Machine ...
193572	—	Field Coil (left) for 193571
193573	—	Field Coil (right) for 193571
193574	—	Field Coil, complete, Nos. 193575 and 193576, for P.G.K. 7 Motor for 15K91 Machine ...
193575	—	Field Coil (left) for 193574
193576	—	Field Coil (right) for 193574
193577	—	Field Coil, complete, Nos. 193578 and 193579, for P.G.K. 8 Motor for 15K91 Machine ...
193578	—	Field Coil (left) for 193577
193579	—	Field Coil (right) for 193577
193580	—	Field Coil, complete, Nos. 193581 and 193582, for P.G.K. 9 Motor for 15K91 Machine ...
193581	—	Field Coil (left) for 193580
193582	—	Field Coil (right) for 193580
193583	—	Field Coil, complete, Nos. 193584 and 193585, for P.G.K. 10 and P.G.K. 11 Motors for 15K91 Machine
193584	—	Field Coil (left) for 193583
193585	—	Field Coil (right) for 193583
193586	2090	Field Coil, complete, Nos. 193587 and 193588, for P.G.K. 12 Motor for 15K91 Machine ...
193587	—	Field Coil (left) for 193586
193588	—	Field Coil (right) for 193586
193589	—	Field Coil, complete, Nos. 193590 and 193591, for P.G.K. 15 Motor for 15K91 Machine ...
193590	—	Field Coil (left) for 193589
193591	—	Field Coil (right) for 193589
193592	—	Field Coil, complete, Nos. 193593 and 193594, for P.G.K. 87 Motor for 15K91 Machine ...
193593	—	Field Coil (left) for 193592
193594	—	Field Coil (right) for 193592
193595	—	Field Coil, complete, Nos. 193596 and 193597, for P.G.K. 90 Motor for 15K91 Machine ...

No.	Plate	
193596	—	Field Coil (left) for 193595
193597	—	Field Coil (right) for 193595
193598	—	Field Coil, complete, Nos. 193599 and 193600, for P.G.K. 92 Motor for 15K91 Machine ...
193599	—	Field Coil (left) for 193598
193600	—	Field Coil (right) for 193598
193629	4964	Three-Pin Terminal Body (male half) Bracket for 15K91 Machine
193640	4959	Grease Wick Spring Retainer for 15K91 Machine
*193644	—	Motor Frame 193545, with 190b, 51303b, 51319b, 125326, 125365, 125366, 125376 and 125462 for 15K91 Machine ...
*193700	—	Three-Pin Terminal Body (male half) 192642 with three 192793, for 192797 ...
193799	—	Brush (carbon) for 150 to 250 volts for 15K91 Machine
194113	2091	Brush Tube for 15K91 Machine
194120	—	SINGER Light Lamp
<i>NOTE.—When ordering 194120 state voltage required.</i>		
194591	—	Brush (carbon) for 25 and 32 volts for 15K91 Machine
195834	—	Field Coil Lead Terminal Clip for 15K91 Machine
195834	—	Lead Terminal Clip for 192875

NUMERICAL LIST OF PARTS

105

No.	Plate	
198052	2090	Two-Pin Plug for 15K91 Machine ...
198108	---	Two-Pin Plug (Norwegian) for 15K91 Machine
198138	---	Two-Pin Plug (Danish) for 15K91 Machine
198367	---	Two-Pin Plug (Swiss) for 15K91 Machine ...

108

NUMERICAL LIST OF PARTS

No.	Plate	
701719	2091	Three-Pin Terminal Body (male half) Post Washer for 192797
727511	1959	Field Coil Lead Bushing (rubber) for 15K91 Machine
899418	---	Name Plate for P.G.K. 7 Motor
899419	---	Name Plate for all P.G.K. Motors except P.G.K. 7
931275	---	Armature Wire Separator (linen) for 15K91 Machine