

Singer 17-32

Form 19012  
(936)  
Printed in U.S.A.

# LIST OF PARTS

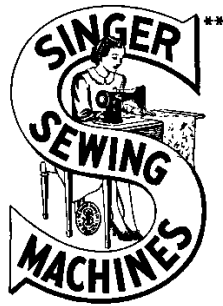

## SINGER\*\*

### MACHINE No. 17-32

---

THE SINGER MANUFACTURING COMPANY

\*\*A Trade Mark of THE SINGER MANUFACTURING COMPANY

## INSTRUCTIONS FOR OILING

---

To ensure easy running and prevent unnecessary wear of the parts which are in movable contact, the machine requires oiling and when in continuous use, "TYPE B" or "TYPE D" OIL, sold by Singer Sewing Machine Company, should be applied at least twice each day to all oil holes marked "OIL", as instructed in Form 7946.

"TYPE D" OIL should be used when an oil is desired which will produce a minimum of stain on fabrics, even after a long period of storage.

Apply a few drops of oil to the shuttle bearings in the shuttle race each time a bobbin is replaced.

## INDEX

---

	Page
Accessories.....	11
Bobbin Winders.....	11
Foot Lifter Parts.....	13
Knee Lifter Parts.....	13
Machine Base.....	11
Machine No. 17-32.....	5
Numerical List of Parts.....	15
Thread Unwinder.....	14

## INSTRUCTIONS FOR ORDERING

In ordering from this list, use **ONLY** the part NUMBER in the **FIRST** column.

The number stamped on a Sewing Machine Part is in every case the number of the single part only.

Every combination of parts sent out as such has its specific number, which, although not stamped on the parts, must be used when ordering the combination.

Each number always indicates the **SAME PART** in whatever list it appears, or for whatever machine.

The letters after some of the numbers indicate the style of finish only, as follows:

- A-Hardened, Polished, Nickel Plated and Buffed
- B-Polished, Nickel Plated and Buffed
- C-Hardened Only
- D-Polished Only
- E-Soft, Not Polished
- F-Hardened and Polished

F.J-Hardened, Polished and Nickel Plated

G-Bright Rumbled and Nickel Plated

H-Blued

J-Nickel Plated Only

K-Hardened and Nickel Plated

L-Brass Plated

M-Oxidized

N-Japanned, Dull

P-Japanned, Bright

R-Merlized

T-Copper Plated

T.A-Hardened, Polished, Copper and Nickel Plated and Buffed

T.B-Copper and Nickel Plated and Polished

T.J-Copper and Nickel Plated Only

T.K-Hardened, Copper and Nickel Plated

T.M-Copper Plated and Oxidized

T.L-Copper and Brass Plated

U-Zinc Plated

V-Silver Plated

W-Polished and Nickel Plated

Y-Black Nickel Plated Only

Z-Chromium Plated

Z.B-Polished, Nickel Plated, Buffed and Chromium Plated

Z.J-Nickel and Chromium Plated

These letters **MUST BE USED** when they appear in the list; and **AFTER** the number as in the list.

In this series:

1 to 1500, 50001 to 51500 and 140001 to 142000 are Screw Numbers

1501 to 1800 and 51501 to 51800 are Nut Numbers

1801 to 2000 and 51901 to 52000 are Roller Numbers

2001 to 50000 and 52001 to 140000 and 142001 to

190000 are Sewing Machine Parts, 190001 and upward

are numbers of Electrical Parts.

The figures in the second column refer only to the plates, illustrating the parts, and are **NOT TO BE USED** in ordering.

Parts marked with an asterisk (\*) are furnished only when repairs are made at factory.

## LIST OF PARTS COMPLETE

FOR

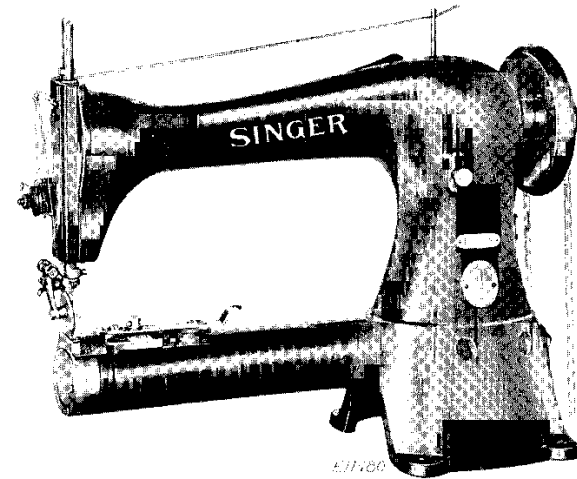

**MACHINE No. 17-32**

For Pumps, Eyelet Ties, Blucher Oxfords, Etc. Has  
Horizontal Under Trimmer, Cylinder Bed 2 7/16 inches diameter,  
Drop Feed Across Arm and Roller Presser. Speed 1800 R. P. M.

No.	Plate	Name
*65115	----	Arm with 4448, 4449, 15404 and two 15405
4389	20887	" Dowel Pin.....
4448	20887	" Oil Tube for oiling intermediate bearing.....
	123E 20887	Arm Screw.....
65116	20906	" Shaft.....
*65117	----	" " 65116 with 16269 and 65118....
3005	20888	" " Bushing (back).....
448C	20887	" " " Set Screw.....
*4449	20888	" " " (front).....
144D	20887	" " Screw.....
4288	20888	" Side Cover.....
51224W	20887	" " Thumb Screw.....
12403	20887	" Spool Pin and Thread Eyelet.....
8879	20890	" " " Washer (cloth).....
16267	20906	Balance Wheel (disc, power) 2 3/4 in. pulley with two 448C.....
16278	20906	Balance Wheel (disc, stand) 3 in. pulley, for 3022.....

No.	Plate	Name
448C	20887	Balance Wheel Set Screw.....
256J	20888	Clamp Stop Motion Clamp Screw.....
248A	20887	" " " " Stop Screw.....
2020	20888	" " " " Washer.....
*3023	-----	" " " " Flanged Bushing.....
4933	20888	" " " " " 3023 with two 462C.....
2022	20887	Clamp Stop Motion Flanged Bushing Pin...
462C	20887	" " " " " Set Screw
3022	-----	Clamp Stop Motion complete, Nos. 248A, 256J 2020 and 4933.....
4292	20903	Crank Connecting Rod with two 145E.....
145E	20887	" " " " Cap Screw.....
375C	20887	" " " " Hinge Screw.....
1518J	20887	" " " " " Nut....
*16812	-----	Cylinder, 2 7/16 in. diam.....
4343	20905	Face Plate.....
56796	-----	" " 4343 with 2105.....
56775	-----	Face Plate complete, Nos. 448C, 460C, 2107, 2111, 2127, 2269, 4369, 56791, 56796 and two 233J.....
164J	20887	Face Plate Screw.....
2107	20887	" " Thread Guard.....
233J	20887	" " " " Screw.....
65113	20888	Feed Cam and Arm Shaft Counterbalance with 435C.....
435C	20887	Feed Cam and Arm Shaft Counterbalance Set Screw.....
3033	20890	Feed Connecting Link.....
375C	20887	" " " " Hinge Screw.....
1518J	20887	" " " " " Nut....
16744	20889	" Dog, 12 teeth (16 teeth to the inch) for 65103.....
16846	20889	Feed Dog, 17 teeth (24 teeth to the inch) for 65103.....
65058	20389	" " (diagonal spiked teeth) for 65103.....
6016	20889	Feed Dog Carrier.....
225C	20889	" " Screw.....
3037	20903	" Forked Connection.....
375C	20887	" " " " Hinge Screw.....
1518J	20887	" " " " " Nut..
3039	20888	" Regulator.....
58E	20887	" " Hinge Screw.....
813D	20887	" " Thumb Screw.....
65114	20906	" Rock Shaft.....
65120	-----	" " " 65114 with 6016.....
6018	20888	" " " Crank with 207F.....
156F	20887	" " " " Position Screw.....
207F	20887	" " " " Set Screw.....
24586	20891	Knife without Guide (corner bent up) for under trimming.....

No.	Plate	Name
24587	-----	Knife without Guide (corner bent up) and Holder (sectional) complete, for under trimming, Nos. 24174, 24586 and two 602F.....
65063	20891	Knife Driving Lever.....
65064	-----	Knife Driving Lever complete, Nos. 104D, 217J, 16749, 24173, 65063 and 65065...
65065	20891	Knife Driving Lever Adjusting Block with 24177.....
217J	20891	Knife Driving Lever Adjusting Block Screw.....
16748	20891	Knife Driving Lever Cam with two 465C...
465C	20891	" " " " Set Screw.....
24170	20891	" " " " Center Plate.....
24171	20891	" " " " " Cap....
934J	20891	" " " " " " Screw
756D	20891	" " " " " " Screw..
16749	20891	" " " " Fork.....
16750	20891	" " " " Cover.....
233J	20887	" " " " " " Screw....
24173	20891	" " " " " Swivel.....
104D	20891	" " " " " " Screw....
16751	20892	" " " " Plate.....
16752	20892	" " " " " Holder.....
1346D	20892	" " " " " " Screw...
50027F	20892	" " " " " " Screw.....
24174	20892	" Holder.....
1098C	20892	" " Adjusting Screw.....
886C	20892	" " " " Binding Screw.....
24175	20892	Knife Holder Bushing.....
16753	20892	" " Position Spring.....
24177	20892	" " " Stud.....
24188	-----	" " Regulator, Nos. 886C and 1098C
50998K	20892	" " Screw.....
1097F	20892	" " Stop Screw.....
602F	20891	" " Screw.....
65119	20903	Needle Bar (hollow).....
*3045	20890	" " Connecting Link.....
56773	-----	" " " " 3045 with 2052
377C	20887	" " " " Hinge Screw...
1518J	20887	" " " " " " Nut
2052	20893	" " " " Stud with 155C....
155C	20893	" " " " " Set Screw....
290E	20893	" " " Screw Bushing.....
16813	20893	" Clamp with 196F.....
16814	-----	Needle Clamp complete, Nos. 665J, 16813 and 16815.....
196F	20893	Needle Clamp Screw.....
16815	20893	" " Thread Guide.....
665J	20893	" " " " Screw.....
*6022	20888	Oscillating Rock Shaft with 4784.....

No.	Plate	Name
16806	-----	Oscillating Rock Shaft complete, Nos. 6022 and 65131.....
65130	20888	Oscillating Rock Shaft Hinge Pin.....
65131	-----	" " " " " " 65130 with 1513J.....
1513J	20893	Oscillating Rock Shaft Hinge Pin Nut....
4784	20893	" " " Oil Pad (felt)...
16754	20905	" Shaft.....
*6056	20893	" " Crank with 460C and 1813.....
6024	20893	Oscillating Shaft Crank with 1813 and two 462C.....
2049	20893	Oscillating Shaft Crank Pin.....
1813	20893	" " " Roller and Stud.
460C	20893	" " " Set Screw for 6056.....
462C	20887	Oscillating Shaft Crank Set Screw for 6024.....
3054	20903	Presser Bar.....
52016	20890	" " Lifter.....
689C	20893	" " " Screw.....
1520J	20893	" " " Nut.....
5808	20890	" " Lifting Bracket with 453C...
453C	20893	" " " " Set Screw...
290E	20893	" " Screw Bushing.....
3056	20890	" " Spring (heavy).....
2308	20890	" " " (light).....
2070	20893	" " " Washer.....
262J	20893	Pressure Regulating Thumb Screw.....
1987	20894	Roller, 1 1/4 in. diam., coarse, with 386D and 1528J, for 16755.....
1932	-----	Roller, 1 1/4 in. diam., fine, with 386D and 1528J, for 65046.....
16098	20895	Roller Arm.....
440F	20895	" " Adjusting Screw.....
1547J	20895	" " " " Nut.....
4282	20895	" " Bracket.....
316F	20895	" " " Screw Center.....
1547J	20895	" " " " Nut.....
2205	20895	" " Lock Spring.....
176J	20895	" " " " Screw.....
1549J	20895	" " " " " Nut.....
16755	20894	Roller Presser complete, 1 1/4 in. coarse roller, Nos. 176J, 440F, 1549J, 1987, 2205, 4282, 16098, two 316F and three 1547J.....
386D	20895	Roller Screw.....
1528J	20895	" " Nut.....
65046	20894	Roller Presser complete, 1 1/4 in. fine roller, Nos. 176J, 440F, 1549J, 1932, 2205, 4282, 16098, two 316F and three 1547J.....

No.	Plate	Name
16232	20895	Roller Ball.....
1768C	20895	" " Retaining Nut.....
50553C	20895	" " Screw.....
1528J	20895	" " Nut.....
51860	20894	Roller, 1 1/4 in. diam., 7/32 in. face, coarse (ball bearing) complete, Nos. 1528J, 1768C, 50553C and twenty-four 16232.....
16230	20895	Roller Arm.....
440F	20895	" " Adjusting Screw.....
1547J	20895	" " " " Nut.....
4282	20895	" " Bracket.....
316F	20895	" " " Screw Center.....
1547J	20895	" " " " Nut.....
2205	20895	" " Lock Spring.....
176J	20895	" " " " Screw.....
1549J	20895	" " " " " Nut.....
65041	20894	Roller Presser (ball bearing) complete, 1 1/4 in. coarse roller, Nos. 176J, 440F, 1549J, 2205, 4282, 16230, 51860, two 316F and three 1547J.....
190J	20895	Roller Presser Screw.....
2073	20896	Shuttle Bobbin.....
2211	20897	" " Retaining Spring.....
2212	20897	" " " Rivet...
*6058	-----	" " Body with 398E, 2082, 2084, 2211 and two 2212.....
*1458	-----	Shuttle Cover.....
125017	-----	" " 1458 with 112E, 466H, 2078, 2080, 2086 and 2090.....
2076	20896	Shuttle Cover Hinge Pin.....
2078	20897	" Delivery Eye Thread Guard.....
2080	20897	" " " " Rivet..
2082	20897	" Main Spring.....
398E	20897	" " " Screw.....
2084	20897	" " " Steady Pin.....
466H	20897	" Tension Regulating Screw.....
2086	20897	" " Spring.....
2090	20897	" " Plate.....
112E	20897	" " " " Screw.....
16892	20896	Shuttle (high point) complete, Nos. 2073, 2076, 6058 and 125017.....
6029	20897	Shuttle Driver and Feed Lifting Cam....
2049	20893	" " " " " Pin.
16816	20896	" Race.....
50037F	20895	" " Screw.....
16756	-----	" " Ring.....
16757	20896	" " " 16756 with 65059 and two 767J.....
16688	-----	Shuttle Race Ring Cover.....
16689	20897	" " " " 16688 with 16242 and two 725J.....

No.	Plate	Name
16242	20897	Shuttle Race Ring Cover Latch.....
725J	20895	" " " " " Screw.....
50250J	20895	" " " " " Screw.....
175J	20895	" " " " " Screw.....
65059	20896	" " " " " Thread Protector.....
767J	20897	" " " " " Screw.....
2102	20898	Tension Disc.....
1560C	20898	" Regulating Thumb Nut.....
4369	20898	" Releaser.....
2269	20898	" " Hinge Pin.....
600C	20898	" " Screw Stud.....
16202	-----	" " " 600C with 1560C.....
448C	20887	" " " Set Screw.....
2103	20898	" " Spring.....
2105	20898	" " Thread Guard.....
56791	-----	Tension complete, Nos. 2103, 2124, 16202 and two 2102.....
2112	20898	Thread Retaining Disc with 2113.....
2113	20898	" " " Steady Pin.....
2114	20898	" " " Spring.....
2115	20898	" " " Stud.....
460C	20893	" " " Set Screw.....
2111	20898	Thread Retainer Guide complete, Nos. 2112, 2114 and 2115.....
*16269	-----	Thread Take-up Cam.....
16270	20888	" " " 16269 with 446C.....
3012	20898	" " " Pin.....
446C	20898	" " " Set Screw.....
*3072	20898	" " " Lever with 1819.....
56855	-----	" " " 3072 with 1088C....
1088C	20898	" " " Hinge Screw.....
1819	20898	" " " Roller and Stud....
2124	20898	" " " Spring.....
2127	20898	" " " Regulator Plate...
233J	20887	" " " " Ad-justing Screw.....
65102	-----	Throat Plate.....
65103	20889	Throat Plate complete, for 16744, 16346 and 65058, Nos. 65102, 65104 and two 238D.....
65104	20889	Throat Plate Needle Hole Strip.....
238D	20889	" " " " " Screw....
335D	20889	" " " " " Screw.....
65066	-----	Trimming Attachment (adjustable) complete, Nos. 1097F, 16751, 16753, 24170, 24175, 24186, 24587, 50998K, 65064, two each 756D, 24171 and four 934J.....
6053	20906	Drip Pan.....
*15404	-----	Trade Mark.....
15405	-----	" " " Rivet.....

## MACHINE BASE

No.	Plate	Name
7169	20905	Machine Base with four each 6055, 51070E and wood screws 1 in. No. 12.....
51070E	20901	Machine Bolt with 51581E, to secure machine to base.....
51581E	20901	Machine Bolt Nut.....
6055	20901	" " " Washer.....

## ACCESSORIES

No.	Plate	Name
51072E	20901	Machine Bolt with 51581E, to secure machine to table.....
51581E	20901	Machine Bolt Nut.....
6055	20901	" " " Washer.....
120342	20899	Oiler (copper plated) with 120343.....
120343	20899	" Spout, 3 1/2 in. long.....
26026	20899	Screw Driver (machine).....
26485	20899	" " (shuttle tension).....
4822	20899	Wrench for 1528, 1547 and 1549.....
8908	20899	" " 1520.....
4347	20899	" " 1513 and 1518.....

## BOBBIN WINDERS

## BOBBIN WINDER

(SWINGING AUTOMATIC, LEFT HAND)

No.	Plate	Name
16271	20900	Base.....
27321	20902	Frame.....
50356D	20902	" Hinge Screw.....
1620J	20902	" " " Nut.....
27322	20902	" Spring.....
27541	20900	Pulley.....
27305	20901	Spindle.....
27306	20901	Spool Pin.....
27307	20900	" Stand.....
27308	20900	Spool Stand complete, Nos. 418E, 1562J, 2106 10141, 11241, 27306, 27307 and two each 2455 and wood screws 1 in. No. 10.....
11241	20900	Spool Washer (cloth).....
27326	20902	Stop Latch.....
35D	20902	" " Hinge Screw.....
2455	20901	Tension Disc.....

No.	Plate	Name
1562J	20901	Tension Regulating Thumb Nut.....
418E	20901	" Screw Stud.....
10141	20901	" Spring.....
2106	20901	" Thread Guide.....
16272	20900	Bobbin Winder, Nos. 35D, 1620J, 16271, 27305, 27321, 27322, 27326, 27541, 50356D and two wood screws 1 in. No. 7 F.H.....
16273	-----	Bobbin Winder (swinging automatic, left hand) complete, Nos. 16272 and 27308

## BOBBIN WINDER

(SWINGING AUTOMATIC, RIGHT HAND)

No.	Plate	Name
27540	20900	Base.....
15072	20901	Bobbin Position Pin.....
27302	20902	Frame.....
50356D	20902	" Hinge Screw.....
1620J	20902	" " " Nut.....
27303	20901	" Spring.....
27541	20900	Pulley.....
*27849	-----	Spindle.....
27538	20901	" 27849 with 15072, 27850 and 41828.
*27850	-----	" Collar.....
41828	20901	" " Pin.....
27306	20901	Spool Pin.....
150534	20900	" Stand.....
150535	20900	Spool Stand complete, Nos. 418E, 1562J, 2106 10141, 11241, 27306, 150534, two each 2455 and wood screws 1 in. No. 10....
11241	20900	Spool Washer (cloth).....
27312	20902	Stop Latch.....
35D	20902	" " Hinge Screw.....
2455	20901	Tension Disc.....
1562J	20901	" Regulating Thumb Nut.....
418E	20901	" Screw Stud.....
10141	20901	" Spring.....
2106	20901	" Thread Guide.....
27647	20900	Bobbin Winder, Nos. 35D, 1620J, 27302, 27303, 27312, 27538, 27540, 27541, 50356D and two wood screws 1 in. No. 7.....
150536	-----	Bobbin Winder (swinging automatic, right hand) complete, Nos. 27647 and 150535

## FOOT LIFTER PARTS

No.	Plate	Name
6439	-----	Chain, 36 in. to 45 in., with 56864 and 56865.....
Note: When ordering 6439, state length required.		
4879	20904	Chain Connecting Link for 4885.....
56864	20904	" Hook (large).....
56865	20904	" " (small).....
7170	20905	Lifting Lever.....
802D	20904	" " Hinge Screw.....
16659	20903	" " Spring.....
5608	20890	Presser Bar Lifting Bracket with 453C...
453C	20893	" " " " Set Screw...
5613	20904	Tension Releaser Pin.....
4881	20906	Treadle.....
4882	20904	" Shaft.....
4883	20904	" Spring.....
4884	20906	" Stand.....
4885	20906	Treadle complete, Nos. 4879, 4881 to 4884 and two wood screws 1 in. No. 16...
6344	-----	Foot Lifter complete, Nos. 802D, 4885, 5608, 6439, 7170 and 16659.....

## KNEE LIFTER PARTS

No.	Plate	Name
7170	20905	Lifting Lever.....
802D	20904	" " Hinge Screw.....
16659	20903	" " Spring.....
6333	20906	Pitman.....
5608	20890	Presser Bar Lifting Bracket with 453C...
453C	20893	" " " " Set Screw...
2763	20905	Rock Shaft.....
6334	20905	" " Hanger with two wood screws 1 in. No. 10.....
16646	20905	Rock Shaft Knee Arm.....
16647	-----	Rock Shaft Knee Arm complete, Nos. 2766, 2767 and 16646.....
2766	20905	Rock Shaft Knee Arm Hub with 356C.....
356C	20901	" " " " " Set Screw.....
2767	20905	" " " " Plate with 356C.....
356C	20901	" " " " " Set Screw.....
6337	20905	" " " " Lifting Bracket with two 356C
6338	20905	" " " " " Hook.....
356C	20901	" " " " " Set Screw
2770	20905	" " " " Stop Dog with 356C.....
356C	20901	" " " " " Set Screw.....



No.	Plate	Name
6339	20905	Rock Shaft complete, Nos. 2763, 2770, 6337, 6338, 16647 and two 6334.....
5613	20904	Tension Releaser Pin.....
6330	-----	Knee Lifter complete, Nos. 802D, 5608, 6333, 6339, 7170 and 16659.....

## THREAD UNWINDER

### FOR ONE SPOOL

No.	Plate	Name
225259	8405	Spool Rest with 201018C.....
150203	8405	" " Cushion (felt).....
225388	8405	" " Rod.....
200383C	20901	" " " Set Screw.....
201018C	20901	" " " Set Screw.....
202490	8405	" Stand with 200383C.....
225391	8405	Thread Guide.....
201696J	20901	" " Lock Nut.....
225326	20904	" " Position Cup.....
225324	8405	" " Rod with 208E and 225322....
208E	20901	" " " Screw.....
225322	20901	" " " Washer.....
225260	8405	Thread Unwinder complete, Nos. 150203, 201696J, 202490, 225259, 225324, 225326 225388, 225391 and three wood screws 7/8 in. No. 12.....
27739	8405	Thread Cone (wood) for large cones.....
225390	8405	" " Holder, for inverted cones..

Note: Nos. 27739 and 225390 are used with, but not included in 225260.

**SINGER** Needles should be used  
in **SINGER** Machines  
These Needles and their Containers  
are marked with the  
Company's Trade Mark "**SIMANCO**."\*\* 1

Needles in Containers marked  
"**FOR SINGER MACHINES**"  
are NOT **SINGER** made needles. 2

## NUMERICAL LIST OF PARTS

No.	Plate	Name
35D	20902	Bobbin Winder Stop Latch Hinge Screw, for 16272 and 27647.....
58E	20887	Feed Regulator Hinge Screw.....
104D	20891	Knife Driving Lever Fork Swivel Screw, for 65064.....
112E	20897	Shuttle Tension Spring Plate Screw, for 125017.....
123E	20887	Arm Screw.....
144D	20887	" Shaft Screw.....
145E	20887	Crank Connecting Rod Cap Screw, for 4292.
155C	20893	Needle Bar Connecting Stud Set Screw, for 2052.....
156F	20887	Feed Rock Shaft Crank Position Screw....
164J	20887	Face Plate Screw.....
175J	20895	Shuttle Race Ring Screw.....
176J	20895	Roller Arm Lock Spring Screw, for 16755, 65041 and 65046.....
190J	20895	Roller Presser Screw.....
196F	20893	Needle Clamp Screw, for 16813.....
207F	20887	Feed Rock Shaft Crank Set Screw, for 6018
208E	20901	Thread Unwinder Thread Guide Rod Screw, for 225324.....
217J	20891	Knife Driving Lever Adjusting Block Screw, for 65064.....
225C	20889	Feed Dog Screw.....
233J	20887	Face Plate Thread Guard Screw, for 56775
233J	20887	Knife Driving Lever Fork Cover Screw....
233J	20887	Thread Take-up Spring Regulator Plate Adjusting Screw.....
238D	20889	Throat Plate Needle Hole Strip Screw, for 65103.....
248A	20887	Clamp Stop Motion Clamp Stop Screw, for 3022.....
256J	20888	Clamp Stop Motion Clamp Screw, for 3022.
262J	20893	Pressure Regulating Thumb Screw.....
290E	20893	Needle Bar Screw Bushing.....
290E	20893	Presser Bar Screw Bushing.....
316F	20895	Roller Arm Bracket Screw Center, for 16755, 65041 and 65046.....
335D	20889	Throat Plate Screw.....
356C	20901	Rock Shaft Knee Arm Hub Set Screw, for 2766.....
356C	20901	Rock Shaft Knee Plate Set Screw, for 2767
356C	20901	" " Lifting Bracket Hook Set Screw, for 6337.....
356C	20901	Rock Shaft Stop Dog Set Screw, for 2770.
375C	20887	Feed Connecting Link Hinge Screw.....
375C	20887	" Forked Connection Hinge Screw.....
375C	20887	Crank Connecting Rod Hinge Screw.....

## NUMERICAL LIST OF PARTS

No.	Plate	Name
377C	20887	Needle Bar Connecting Link Hinge Screw..
386D	20895	Roller Screw, for 1932 and 1987.....
398E	20897	Shuttle Main Spring Screw, for 6058.....
418E	20901	Bobbin Winder Tension Screw Stud, for 27308 and 150535.....
435C	20887	Feed Cam and Arm Shaft Counterbalance Set Screw, for 65118.....
440F	20895	Roller Arm Adjusting Screw, for 16755, 65041 and 65046.....
446C	20898	Thread Take-up Cam Set Screw, for 16270..
448C	20897	Arm Shaft Bushing (back) Set Screw.....
448C	20887	Balance Wheel Set Screw, for 16287.....
448C	20887	Tension Screw Stud Set Screw, for 56775..
453C	20893	Presser Bar Lifting Bracket Set Screw, for 5608.....
460C	20893	Oscillating Shaft Crank Set Screw, for 6056.....
460C	20893	Thread Retaining Stud Set Screw, for 56775.....
462C	20887	Clamp Stop Motion Flanged Bushing Set Screw, for 4933.....
462C	20887	Oscillating Shaft Crank Set Screw, for 6024.....
465C	20891	Knife Driving Lever Cam Set Screw, for 16748.....
466H	20897	Shuttle Tension Regulating Screw, for 125017.....
600C	20898	Tension Screw Stud, for 16202.....
602F	20891	Knife Screw, for 24587.....
665J	20893	Needle Clamp Thread Guide Screw, for 16814.....
689C	20893	Presser Bar Lifter Screw.....
725J	20895	Shuttle Race Ring Cover Latch Screw, for 16689.....
756D	20891	Knife Driving Lever Center Plate Screw, for 65066.....
767J	20897	Shuttle Race Ring Thread Protector Screw for 16757.....
802D	20904	Lifting Lever Hinge Screw, for 6330 and 6344.....
818D	20887	Feed Regulator Thumb Screw.....
886C	20892	Knife Holder Adjusting Screw Binding Screw, for 24188.....
934J	20891	Knife Driving Lever Center Plate Cap Screw, for 65066.....
1088C	20898	Thread Take-up Lever Hinge Screw, for 56855.....
1097F	20892	Knife Holder Stop Screw, for 65066.....
1098C	20892	" " Adjusting Screw, for 24188..
1346D	20892	" Driving Lever Plate Holder Screw..
1513J	20893	Oscillating Rock Shaft Hinge Pin Nut, for 65131.....

## NUMERICAL LIST OF PARTS

No.	Plate	Name
1518J	20887	Crank Connecting Rod Hinge Screw Nut....
1518J	20887	Feed Connecting Link Hinge Screw Nut....
1518J	20887	" Forked Connection Hinge Screw Nut..
1518J	20887	Needle Bar Connecting Link Hinge Screw Nut.....
1520J	20893	Presser Bar Lifter Screw Nut.....
1528J	20895	Roller Screw Nut, for 1932, 1987 and 51860
1547J	20895	" Arm Adjusting Screw Nut, for 18755 65041 and 65046.....
1547J	20895	Roller Arm Bracket Screw Center Nut, for 16755, 65041 and 65046.....
1549J	20895	Roller Arm Lock Spring Screw Nut, for 16755, 65041 and 65046.....
1560C	20898	Tension Regulating Thumb Nut, for 16202.
1582J	20901	Bobbin Winder Tension Regulating Thumb Nut, for 27308 and 150535.....
1620J	20902	Bobbin Winder Frame Hinge Screw Nut, for 16272 and 27647.....
1766C	20895	Roller Ball Retaining Nut, for 51860....
1813	20893	Oscillating Shaft Crank Roller and Stud, for 6024 and 6056.....
1819	20898	Thread Take-up Lever Roller and Stud, for 3072.....
1932	-----	Roller, 1 1/4 in.diam., fine with 386D and 1528J, for 65046.....
1987	20894	Roller, 1 1/4 in.diam., coarse with 386D and 1528J, for 16755.....
2020	20888	Clamp Stop Motion Clamp Washer, for 3022
2022	20887	" " " Flanged Bushing Pin...
2049	20893	Oscillating Shaft Crank Pin.....
2049	20893	Shuttle Driver and Feed Lifting Cam Pin.
2052	20893	Needle Bar Connecting Stud with 155C, for 56773.....
2070	20893	Presser Bar Spring Washer.....
2073	20896	Shuttle Bobbin, for 16892.....
2076	20896	" Cover Hinge Pin, for 16892.....
2078	20897	" Delivery Eye Thread Guard, for 125017.....
2080	20897	Shuttle Delivery Eye Thread Guard Rivet, for 125017.....
2082	20897	Shuttle Main Spring, for 6058.....
2084	20897	" " " Steady Pin, for 6058
2086	20897	" Tension Spring, for 125017.....
2090	20897	" " " Plate, for 125017.
2102	20898	Tension Disc, for 56791.....
2103	20898	" Spring, for 56791.....
2105	20898	" Thread Guard, for 56796.....
2106	20901	Bobbin Winder Tension Thread Guide, for 27308 and 150535.....
2107	20887	Face Plate Thread Guard, for 56775.....
2111	20898	Thread Retainer Guide complete, Nos. 2112, 2114 and 2115, for 56775.....

## NUMERICAL LIST OF PARTS

No.	Plate	Name
2112	20898	Thread Retaining Disc with 2113, for 2111
2113	20898	" " " Steady Pin, for 2112.....
2114	20898	Thread Retaining Spring, for 2111.....
2115	20898	" " Stud, for 2111.....
2124	20898	" Take-up Spring, for 58791.....
2127	20898	" " Regulator Plate, for 58775.....
2205	20895	Roller Arm Lock Spring, for 16755, 65041 and 65046.....
2211	20897	Shuttle Bobbin Retaining Spring, for 6058
2212	20897	" " " Rivet, for 6058.....
2269	20898	Tension Releaser Hinge Pin, for 56775...
2308	20890	Presser Bar Spring (light).....
2455	20901	Bobbin Winder Tension Disc, for 27308 and 150535.....
2763	20905	Rock Shaft, for 6339.....
2766	20905	" " Knee Arm Hub with 356C, for 16647.....
2787	20905	Rock Shaft Knee Plate with 356C, for 16647.....
2770	20905	Rock Shaft Stop Dog with 356C, for 6339.
3005	20888	Arm Shaft Bushing (back).....
3012	20898	Thread Take-up Cam Pin.....
3022	-----	Clamp Stop Motion complete, Nos. 248A, 256J 2020 and 4933.....
*3023	-----	Clamp Stop Motion Flanged Bushing, for 4933.....
3033	20890	Feed Connecting Link.....
3037	20903	" Forked Connection.....
3039	20888	" Regulator.....
*3045	20890	Needle Bar Connecting Link, for 56773...
3054	20903	Presser Bar.....
3056	20890	" " Spring (heavy).....
*3072	20898	Thread Take-up Lever with 1819, for 56855
4282	20895	Roller Arm Bracket, for 16755, 65041 and 65046.....
4288	20888	Arm Side Cover.....
4292	20903	Crank Connecting Rod with two 145E.....
4343	20905	Face Plate, for 56796.....
4347	20899	Wrench, for 1513 and 1518 (Accessories).
4369	20898	Tension Releaser, for 56775.....
4389	20887	Arm Dowel Pin.....
4448	20887	" Oil Tube, for oiling intermediate bearing, for 65115.....
*4449	20888	Arm Shaft Bushing (front) for 65115.....
4784	20893	Oscillating Rock Shaft Oil Pad (felt) for 6022.....
4822	20899	Wrench, for 1528, 1547 and 1549 (Accessories).....
4879	20904	Chain Connecting Link, for 4885.....

## NUMERICAL LIST OF PARTS

No.	Plate	Name
4881	20906	Treadle, for 4885.....
4882	20904	" Shaft, for 4885.....
4883	20904	" Spring, for 4885.....
4884	20906	" Stand, for 4885.....
4885	20906	Treadle complete, Nos. 4879, 4881 to 4884 and two wood screws 1 in. No. 16, for 6344.....
4933	20888	Clamp Stop Motion Flanged Bushing 3023 with two 462C, for 3022.....
5608	20890	Presser Bar Lifting Bracket with 453C, for 6330 and 6344.....
5613	20904	Tension Releaser Pin.....
6016	20889	Feed Dog Carrier, for 65120.....
6018	20888	" Rock Shaft Crank with 207F.....
*6022	20888	Oscillating Rock Shaft with 4784, for 16806.....
6024	20893	Oscillating Shaft Crank with 1813 and two 462C.....
6029	20897	Shuttle Driver and Feed Lifting Cam....
6053	20906	Drip Pan.....
6055	20901	Machine Bolt Nut Washer, for 7189.....
*6056	20893	Oscillating Shaft Crank with 460C and 1813.....
*6058	-----	Shuttle Body with 398E, 2082, 2084, 2211 and two 2212, for 16892.....
6330	-----	Knee Lifter complete, Nos. 802D, 5608, 6333, 6339, 7170 and 16659.....
6333	20906	Pitman, for 6330.....
6334	20905	Rock Shaft Hanger with two wood screws 1 in. No. 10, for 6339.....
6337	20905	Rock Shaft Lifting Bracket with two 356C for 6339.....
6338	20905	Rock Shaft Lifting Bracket Hook, for 6339.....
6339	20905	Rock Shaft complete, Nos. 2763, 2770, 6337, 6338, 16647 and two 6334, for 6330..
6344	-----	Foot Lifter complete, Nos. 802D, 4885, 5608, 6439, 7170 and 16659.....
6439	-----	Chain, 36 in. to 45 in. with 56864 and 56865, for 6344.....
7169	20905	Machine Base with four each 6055, 51070E and wood screws 1 in. No. 12.....
7170	20905	Lifting Lever, for 6330 and 6344.....
8879	20890	Arm Spool Pin Washer (cloth).....
8908	20899	Wrench, for 1520 (Accessories).....
10141	20901	Bobbin Winder Tension Spring, for 27308 and 150535.....
11241	20900	Bobbin Winder Spool Washer (cloth) for 27308 and 150535.....
12403	20887	Arm Spool Pin and Thread Eyelet.....
15072	20901	Bobbin Winder Bobbin Position Pin for 27538.....

## NUMERICAL LIST OF PARTS

No.	Plate	Name
*15404	-----	Trade Mark, for 65115.....
15405	-----	" " Rivet, for 65115.....
*15458	-----	Shuttle Cover, for 125017.....
16098	20895	Roller Arm, for 16755 and 65046.....
16202	-----	Tension Screw Stud 600C with 1560C, for 56791.....
16230	20895	Roller Arm, for 65041.....
16232	20895	" Ball, for 51860.....
16242	20897	Shuttle Race Ring Cover Latch, for 16689
16267	20906	Balance Wheel (disc, power) 2 3/4 in. pulley with two 449C.....
*16269	-----	Thread Take-up Cam, for 16270 and 65117.
16270	20888	" " " 16269 with 446C.....
16271	20900	Bobbin Winder Base, for 16272.....
16272	20900	" " Nos.35D,1620J,16271,27305, 27321,27322,27326,27541,50356D and two wood screws 1 in. No. 7 F.H., for 16273.....
16273	-----	Bobbin Winder (swinging automatic, left hand) complete,Nos.16272 and 27308.
16278	20906	Balance Wheel (disc, stand) 3 in. pulley for 3022.....
16646	20905	Rock Shaft Knee Arm, for 16647.....
16647	-----	Rock Shaft Knee Arm complete,Nos.2766, 2767 and 16646, for 6339.....
16659	20903	Lifting Lever Spring, for 6330 and 6344.
16688	-----	Shuttle Race Ring Cover, for 16689.....
16689	20897	" " " 16688 with 16242 and two 725J.....
16744	20889	Feed Dog,12 teeth (16 teeth to the inch) for 65103.....
16748	20891	Knife Driving Lever Cam with two 465C...
16749	20891	" " " Fork, for 65064.....
16750	20891	" " " Cover.....
16751	20892	" " " Plate, for 65066....
16752	20892	" " " Holder.....
16753	20892	" Holder Position Spring, for 65066.
16754	20905	Oscillating Shaft.....
16755	20894	Roller Presser complete,1 1/4 in.coarse roller,Nos.176J,440F,1549J,1987, 2205,4282,16098,two 316F and three 1547J.....
16756	-----	Shuttle Race Ring, for 16757.....
16757	20896	" " " 16756 with 65059 and two 767J.....
16806	-----	Oscillating Rock Shaft complete,Nos.6022 and 65131.....
*16812	-----	Cylinder, 2 7/16 in. diam.....
16813	20893	Needle Clamp with 196F, for 16814.....
16814	-----	Needle Clamp complete,Nos.665J,16813 and 16815.....
16815	20893	Needle Clamp Thread Guide, for 16814....

## NUMERICAL LIST OF PARTS

No.	Plate	Name
16816	20896	Shuttle Race.....
16846	20889	Feed Dog,17 teeth (24 teeth to the inch) for 65103.....
16892	20896	Shuttle (high point) complete,Nos.2073, 2076,6058 and 125017.....
24170	20891	Knife Driving Lever Center Plate,for 65066.....
24171	20891	Knife Driving Lever Center Plate Cap,for 65066.....
24173	20891	Knife Driving Lever Fork Swivel,for 65064.....
24174	20892	Knife Holder, for 24587.....
24175	20892	" " Bushing, for 65066.....
24177	20892	" " Position Stud, for 65065..
24188	-----	" " Regulator,Nos.886C and 1096C, for 65066.....
24586	20891	Knife without Guide (corner bent up) for under trimming, for 24587.....
24587	-----	Knife without Guide (corner bent up) and Holder (sectional) complete,for under trimming,Nos.24174,24586 and two 602F, for 65066.....
26026	20899	Screw Driver (machine) Accessories.....
26485	20899	" " (shuttle tension) Accessories.....
27302	20902	Bobbin Winder Frame, for 27647.....
27303	20901	" " Spring, for 27647..
27305	20901	" " Spindle, for 16272.....
27306	20901	" " Spool Pin, for 27308 and 150535.....
27307	20900	Bobbin Winder Spool Stand, for 27308....
27308	20900	Bobbin Winder Spool Stand complete,Nos. 418E,1562J,2106,10141,11241,27306, 27307 and two each 2455 and wood screws 1 in. No. 10, for 16273.....
27312	20902	Bobbin Winder Stop Latch, for 27647.....
27321	20902	" " Frame, for 16272.....
27322	20902	" " Spring, for 16272...
27326	20902	" " Stop Latch, for 16272....
27538	20901	" " Spindle 27649 with 15072, 27850 and 41828, for 27647.....
27540	20900	Bobbin Winder Base, for 27647.....
27541	20900	" " Pulley,for 16272 and 27647
27647	20900	" " Nos.35D,1620J,27302,27303, 27312,27538,27540,27541,50356D and two wood screws 1 in. No. 7, for 150536.....
27739	8405	Thread Unwinder Thread Cone (wood) for large cones.....
*27849	-----	Bobbin Winder Spindle, for 27538.....
*27850	-----	" " " Collar, for 27538.
41828	20901	" " " " Pin, for 27538.....

## NUMERICAL LIST OF PARTS

No.	Plate	Name
50027F	20892	Knife Driving Lever Plate Screw.....
50037F	20895	Shuttle Race Screw.....
50250J	20895	" " Ring Cover Screw.....
50356D	20902	Bobbin Winder Frame Hinge Screw, for 16272 and 27647.....
50553C	20895	Roller Screw, for 51860.....
50998K	20892	Knife Holder Screw, for 65066.....
51070E	20901	Machine Bolt with 51581E, to secure ma- chine to base, for 7189.....
51072E	20901	Machine Bolt with 51581E, to secure ma- chine to table (Accessories).....
51224W	20887	Arm Side Cover Thumb Screw.....
51581E	20901	Machine Bolt Nut, for 51070E and 51072E..
51860	20894	Roller, 1 1/4 in. diam., 7/32 in. face, coarse (ball bearing) complete, Nos. 1528J, 1766C, 50553C and twenty-four 16232, for 65041.....
52016	20890	Presser Bar Lifter.....
56773	-----	Needle Bar Connecting Link 3045 with 2052.....
56775	-----	Face Plate complete, Nos. 448C, 460C, 2107, 2111, 2127, 2269, 4369, 56791, 56796 and two 233J.....
56791	-----	Tension complete, Nos. 2103, 2124, 16202 and two 2102, for 56775.....
56796	-----	Face Plate 4343 with 2105, for 56775....
56855	-----	Thread Take-up Lever 3072 with 1088C....
56864	20904	Chain Hook (large) for 6439.....
56865	20904	" " (small) for 6439.....
65041	20894	Roller Presser (ball bearing) complete, 1 1/4 in. coarse roller, Nos. 176J, 440F, 1549J, 2205, 4282, 16230, 51860, two 316F and three 1547J.....
65046	20894	Roller Presser complete, 1 1/4 in. fine roller, Nos. 176J, 440F, 1549J, 1932, 2205, 4282, 16098, two 316F and three 1547J.....
65058	20889	Feed Dog (diagonal spiked teeth) for 65103.....
65059	20896	Shuttle Race Ring Thread Protector, for 16757.....
65063	20891	Knife Driving Lever, for 65064.....
65064	-----	Knife Driving Lever complete, Nos. 104D, 217J, 16749, 24173, 65063 and 65065,.. for 65066.....
65065	20891	Knife Driving Lever Adjusting Block with 24177, for 65064.....
65066	-----	Trimming Attachment (adjustable) com- plete, Nos. 1097F, 16751, 16753, 24170, 24175, 24188, 24587, 50998K, 65064, two each 756D, 24171 and four 934J.....
65102	-----	Throat Plate, for 65103.....

## NUMERICAL LIST OF PARTS

No.	Plate	Name
65103	20889	Throat Plate complete, for 16744, 16846 and 65058, Nos. 65102, 65104 and two 238D.....
65104	20889	Throat Plate Needle Hole Strip, for 65103
65114	20906	Feed Rock Shaft, for 65120.....
*65115	-----	Arm with 4448, 4449, 15404 and two 15405..
65116	20906	" Shaft, for 65117.....
*65117	-----	" " 65116 with 16269 and 65118...
65118	20888	Feed Cam and Arm Shaft Counterbalance with 435C, for 65117.....
65119	20903	Needle Bar (hollow).....
65120	-----	Feed Rock Shaft 65114 with 6016.....
65130	20888	Oscillating Rock Shaft Hinge Pin, for 65131.....
65131	-----	Oscillating Rock Shaft Hinge Pin 65130 with 1513J, for 16806.....
120342	20899	Oiler (copper plated) with 120343 (Ac- cessories).....
120343	20899	Oiler Spout, 3 1/2 in. long, for 120343 (Accessories).....
125017	-----	Shuttle Cover 15458 with 112E, 466H, 2078, 2080, 2086 and 2090, for 16892.....
150203	8405	Thread Unwinder Spool Rest Cushion (felt) for 225260.....
150534	20900	Bobbin Winder Spool Stand, for 150535...
150535	20900	Bobbin Winder Spool Stand complete, Nos. 418E, 1562J, 2106, 10141, 11241, 27306, 150534, two each 2455 and wood screws 1 in. No. 10, for 150536.....
150536	-----	Bobbin Winder (swinging automatic, right hand) complete, Nos. 27647 and 150535
200383C	20901	Thread Unwinder Spool Rest Rod Set Screw for 202490.....
201018C	20901	Thread Unwinder Spool Rest Set Screw, for 225259.....
201696J	20901	Thread Unwinder Thread Guide Lock Nut, for 225260.....
202490	8405	Thread Unwinder Spool Stand with 200383C for 225260.....
225259	8405	Thread Unwinder Spool Rest with 201018C, for 225260.....
225260	8405	Thread Unwinder complete, Nos. 150203, 201696J, 202490, 225259, 225324, 225326 225388, 225391 and three wood screws 7/8 in. No. 12.....
225322	20901	Thread Unwinder Thread Guide Rod Washer, for 225324.....
225324	8405	Thread Unwinder Thread Guide Rod with 208E and 225322, for 225260.....
225326	20904	Thread Unwinder Thread Guide Position Cup, for 225260.....
225388	8405	Thread Unwinder Spool Rest Rod for 225260.....

NUMERICAL LIST OF PARTS

No.	Plate	Name
225390	8405	Thread Unwinder Thread Cone Holder, for inverted cones.....
225391	8405	Thread Unwinder Thread Guide, for 225260.

**SINGER Needles should be used in SINGER Machines**  
**These Needles and their Containers are marked with the Company's Trade Mark "SIMANCO.\*\*" 1**

**Needles in Containers marked "FOR SINGER MACHINES" are NOT SINGER made needles. 2**

**PLATE 8405—ONE-FOURTH SIZE**

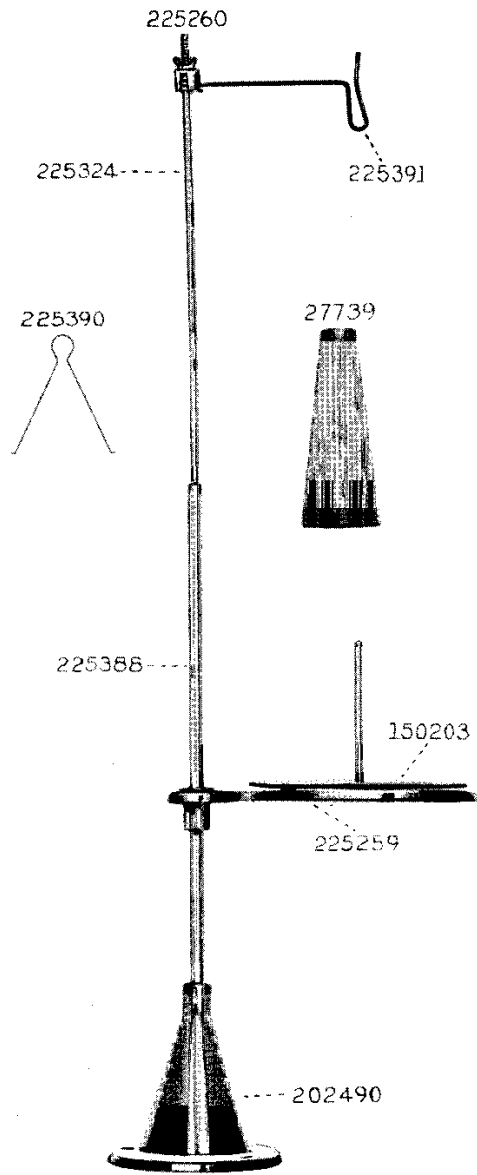

PLATE 20887 - FULL SIZE

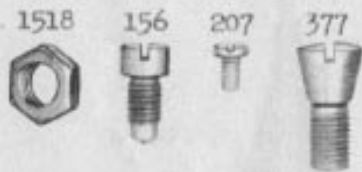
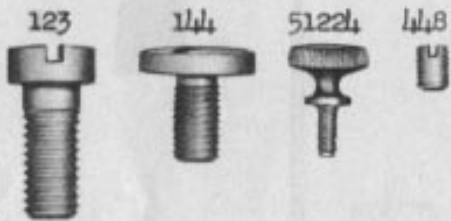
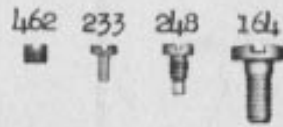
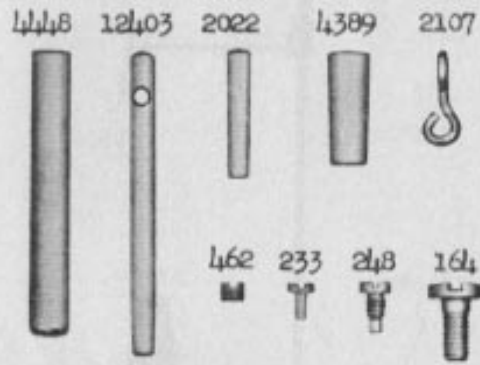

PLATE 20888 - ONE - HALF SIZE

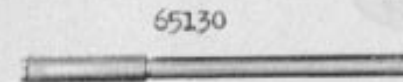
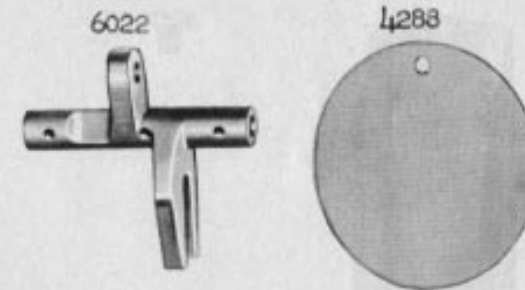

PLATE 20889 - FULL SIZE

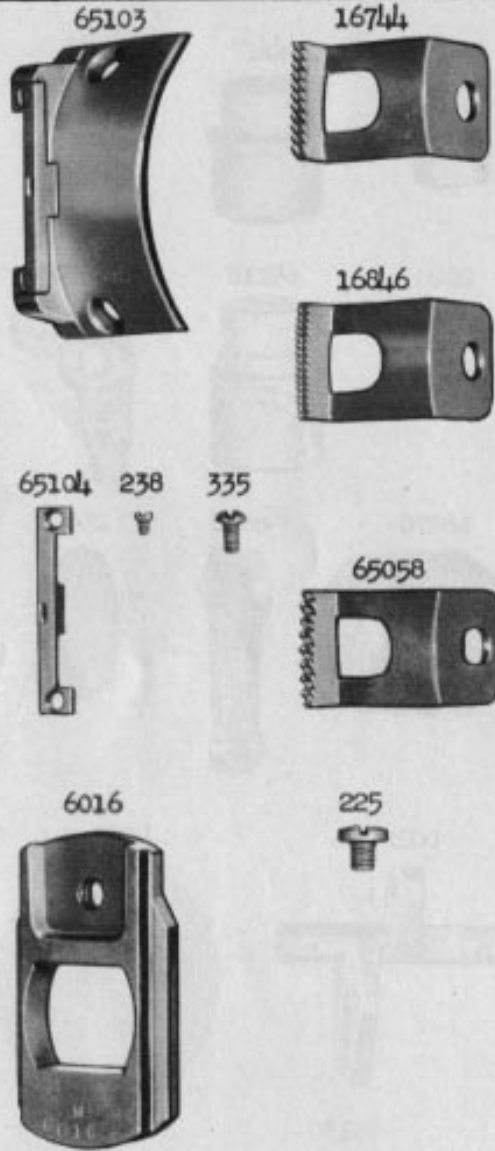

PLATE 20890 - FULL SIZE

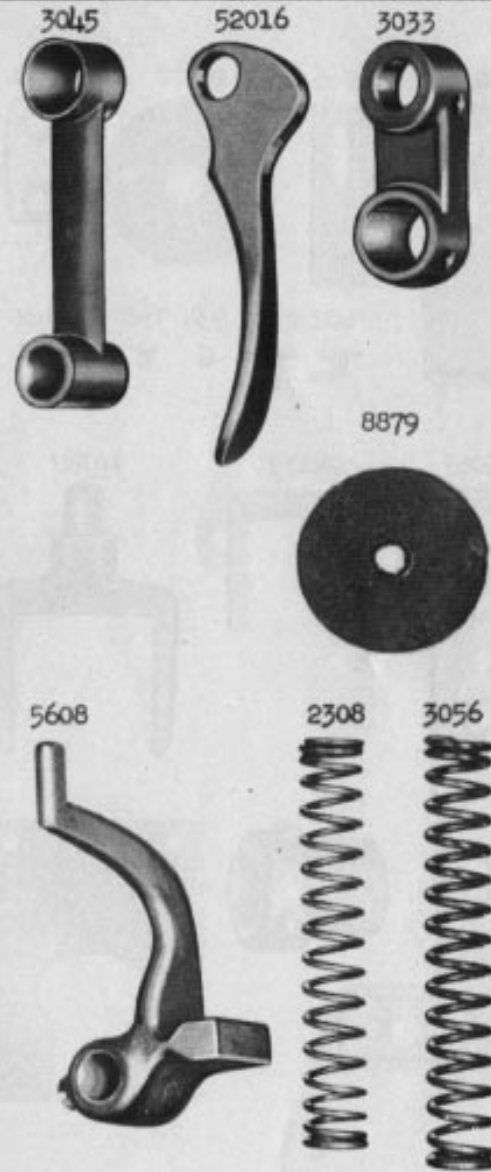



PLATE 20891 - FULL SIZE

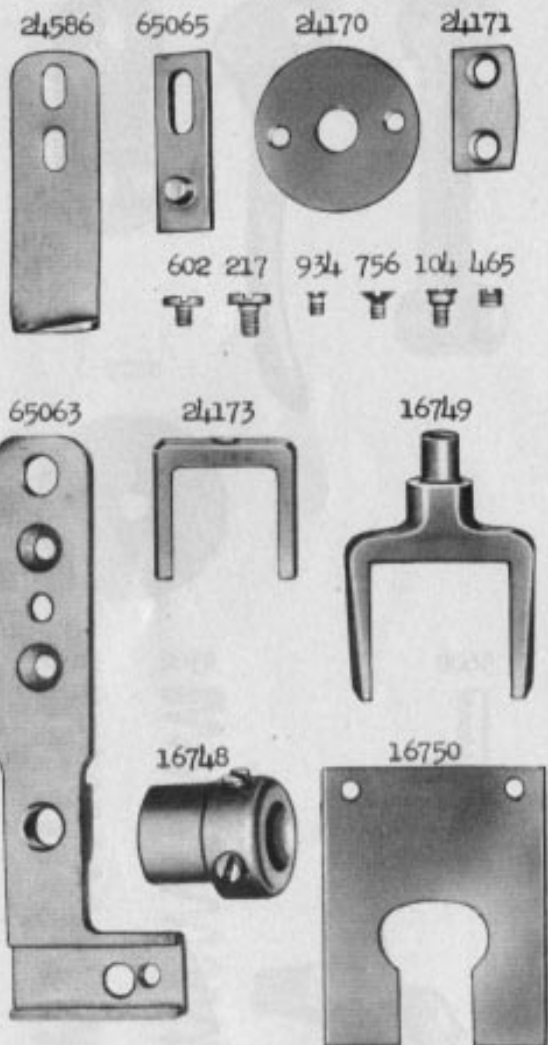

PLATE 20892 - FULL SIZE

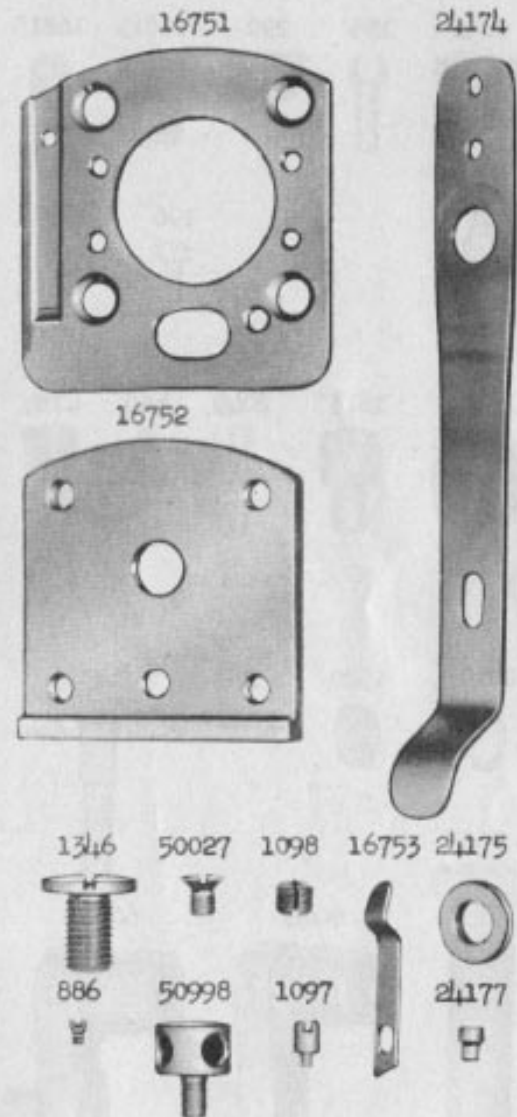

PLATE 20893 - FULL SIZE

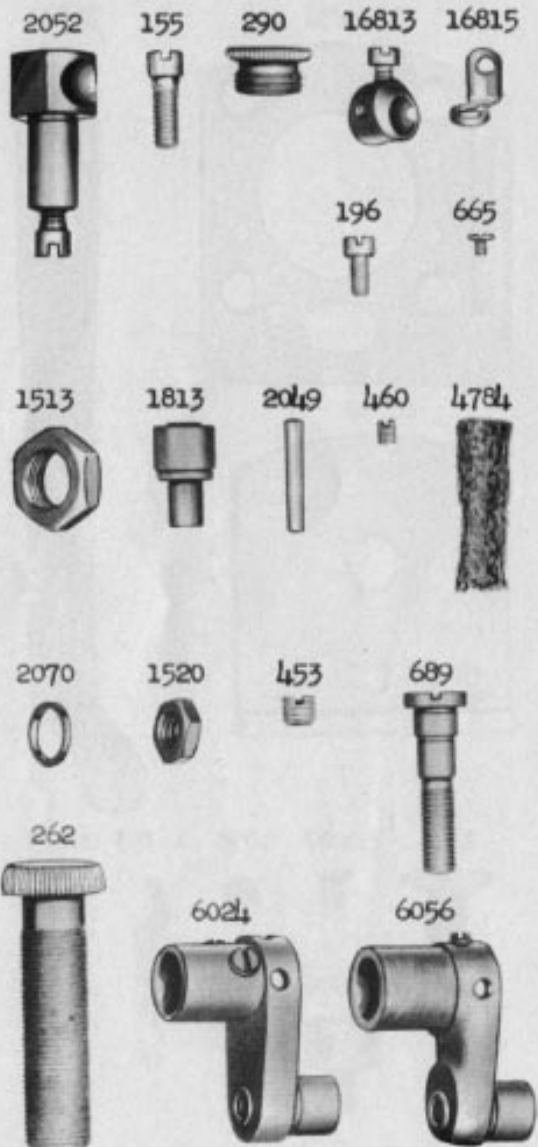

PLATE 20894 - FULL SIZE

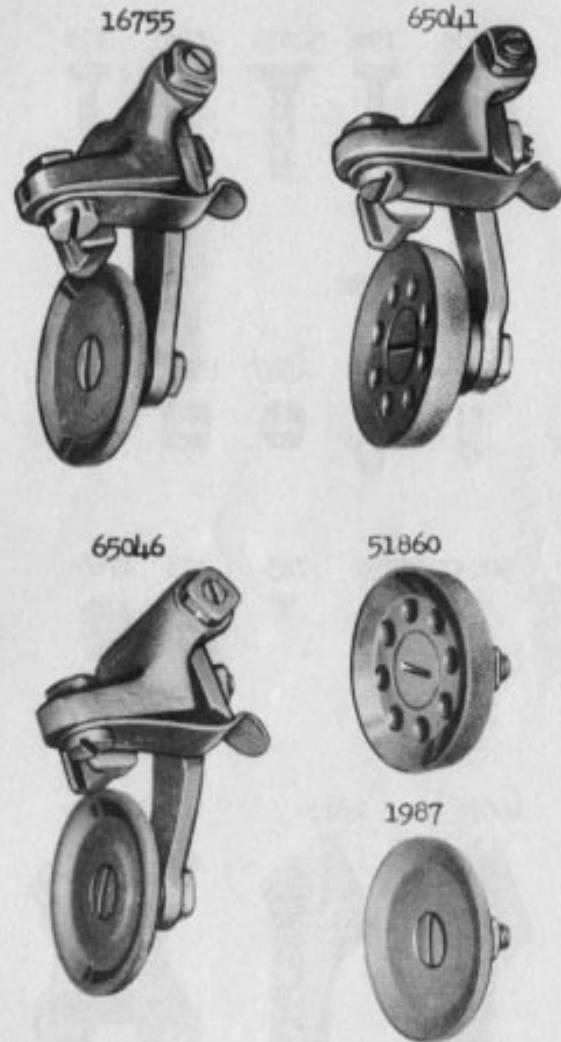
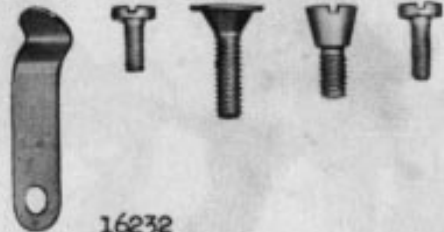

PLATE 20895 - FULL SIZE

2205 190 50553 386 176



16232  
o

316 440 1547 1528 1549



50037 50250 725 175 1766



16098



16230



4282



PLATE 20896 - FULL SIZE

16757



16816



16892



2076



2073



65059



PLATE 20897 - FULL SIZE

16689

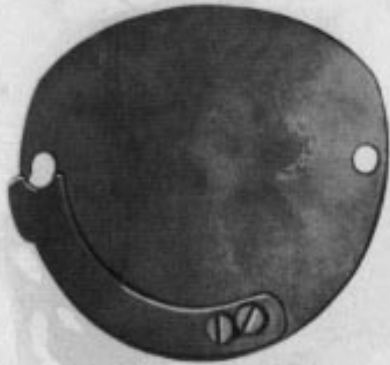

16242

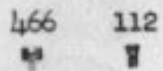
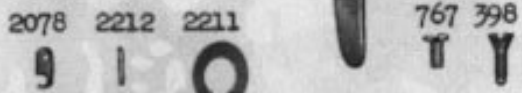
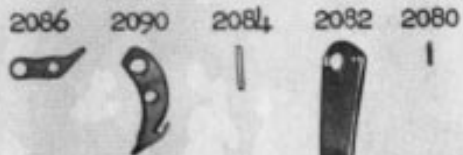

PLATE 20898 - FULL SIZE

4369 2102 2103 2105

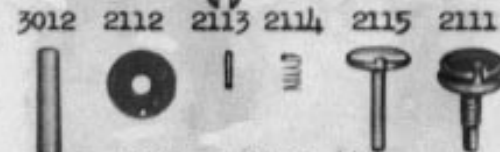
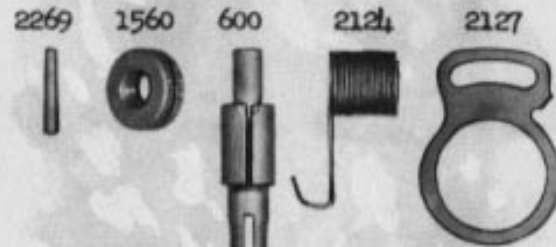
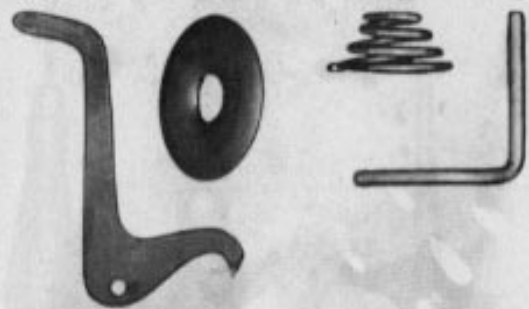

PLATE 20899 - ONE - HALF SIZE

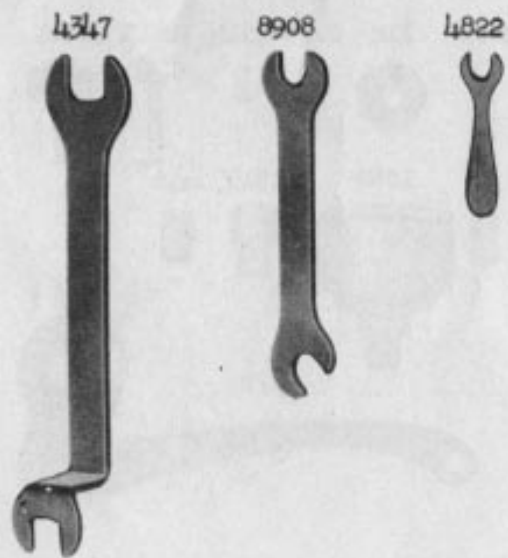
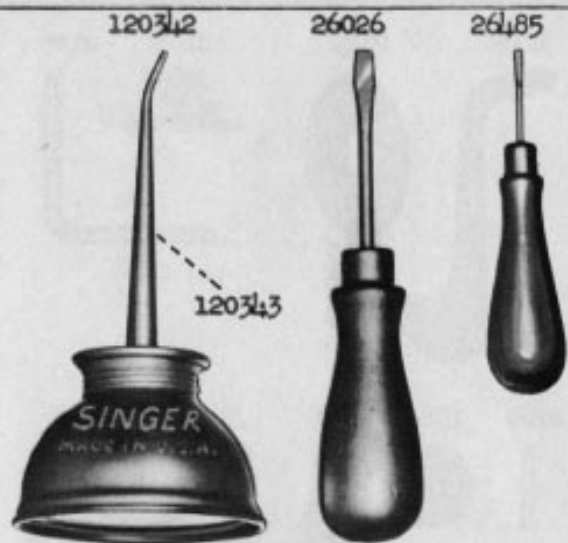

PLATE 20900 - ONE - HALF SIZE

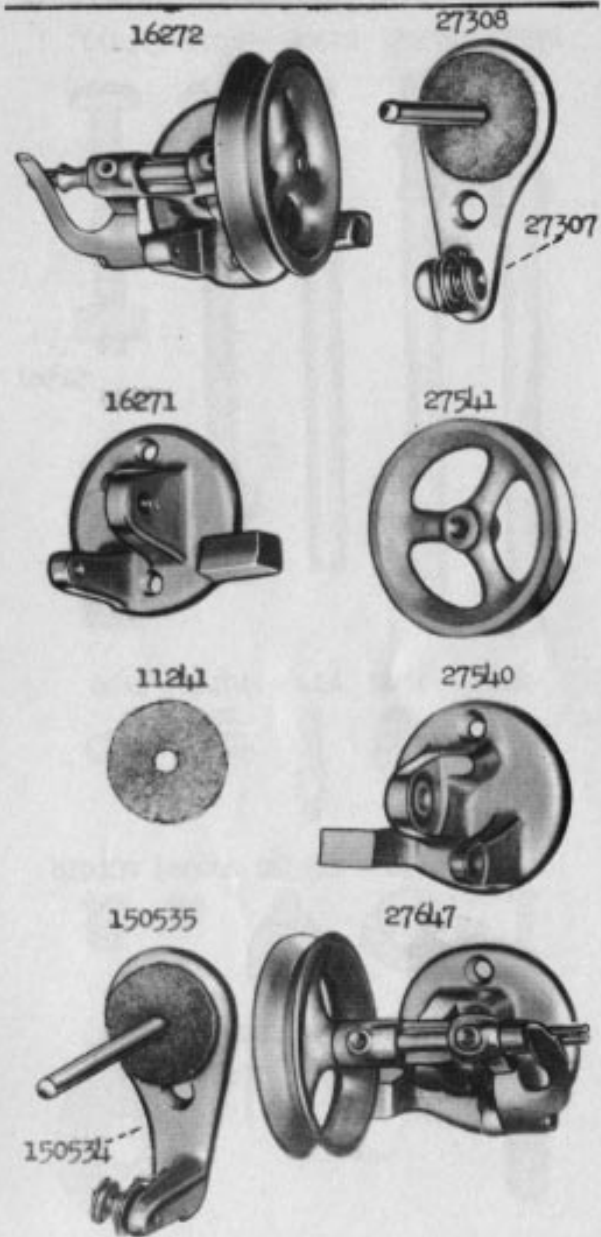

PLATE 20901 - FULL SIZE

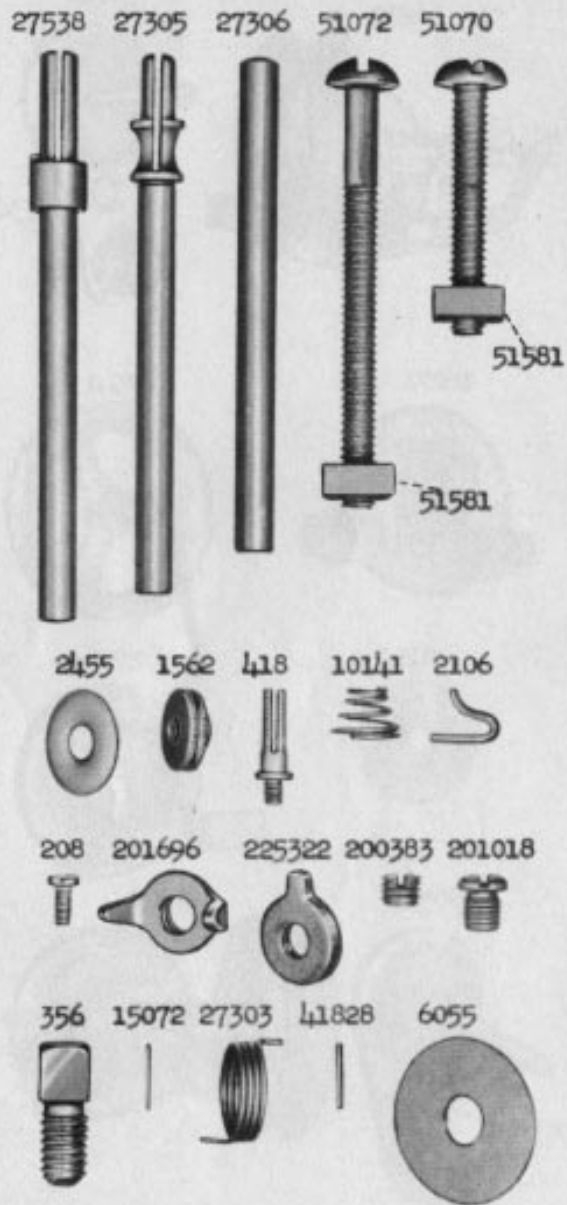

PLATE 20902 - FULL SIZE

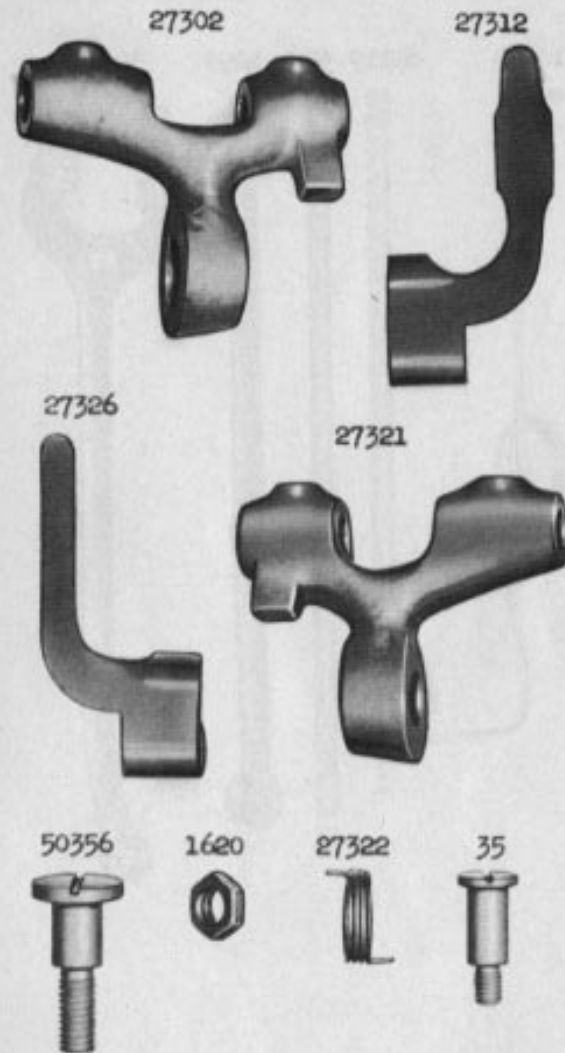

PLATE 20903 - ONE - HALF SIZE

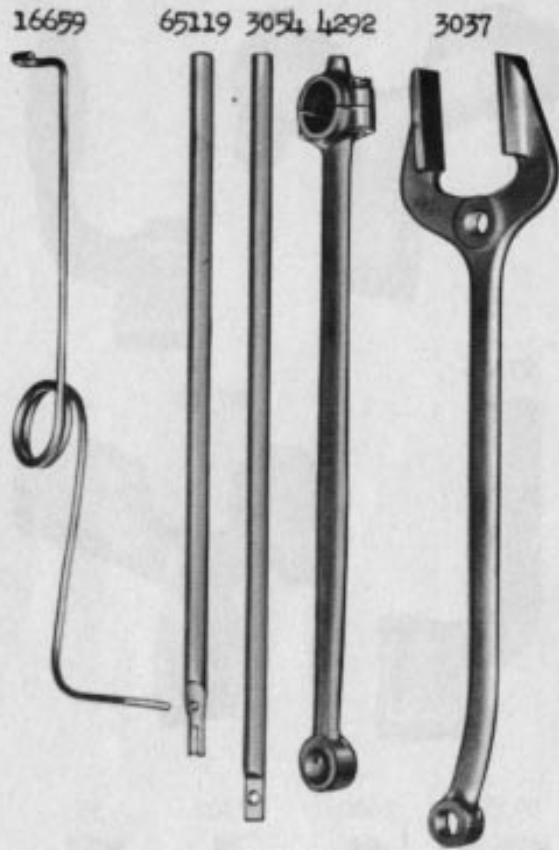

PLATE 20904 - FULL SIZE

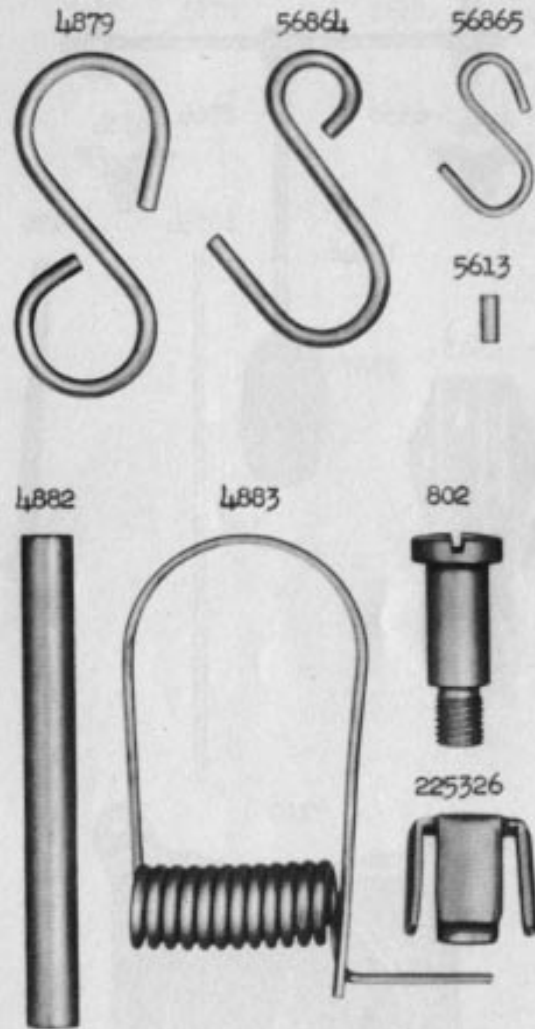

PLATE 20905 - ONE-FOURTH SIZE

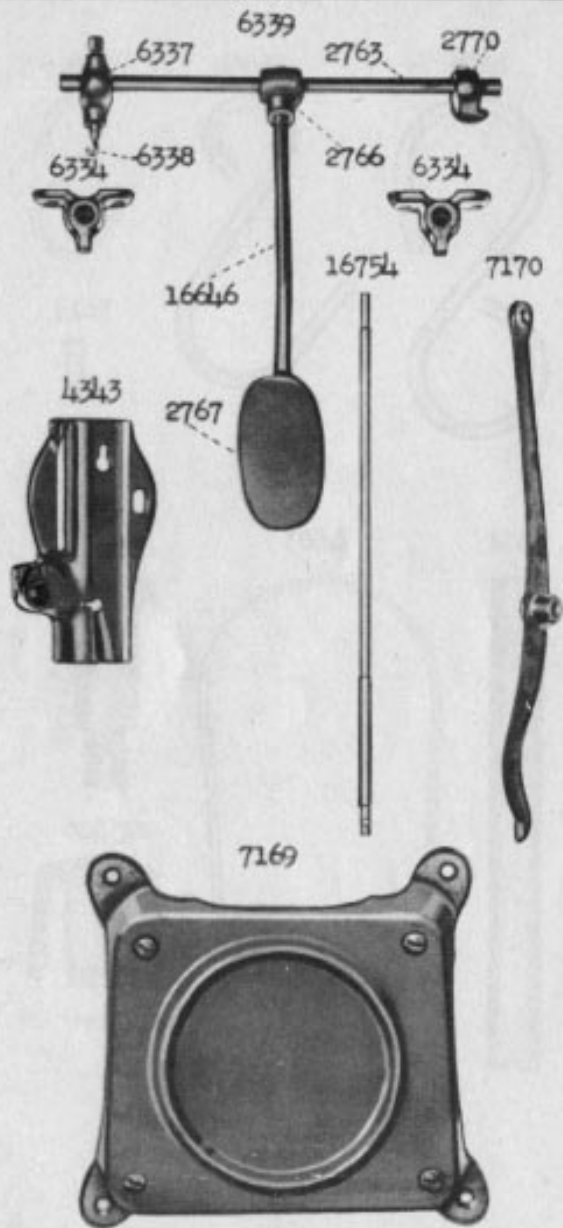

PLATE 20906 - ONE-FOURTH SIZE

