

Form U 3007
Form U 3007
(Rev. 583)
Printed in Japan

MACHINE PARTS CHART **for** **SINGER***

17U230
17U241
17U242

★ A Trademark of THE SINGER COMPANY
Copyright © 1976 THE SINGER COMPANY
All Rights Reserved Throughout the World

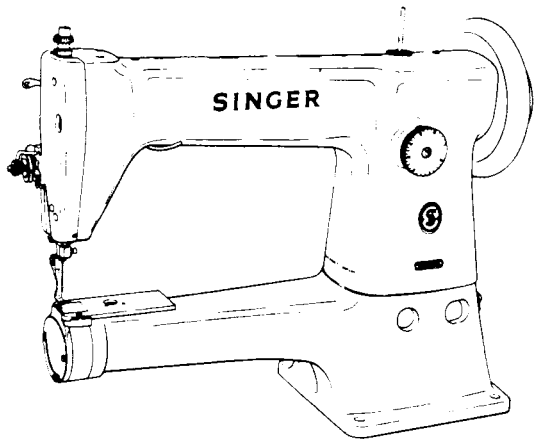

SINGER*

17U241

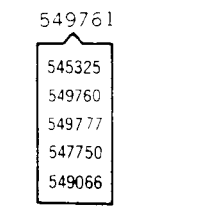
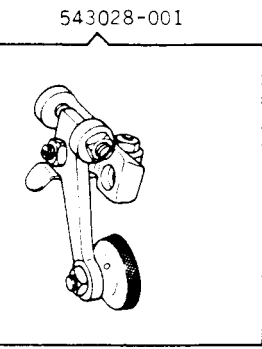
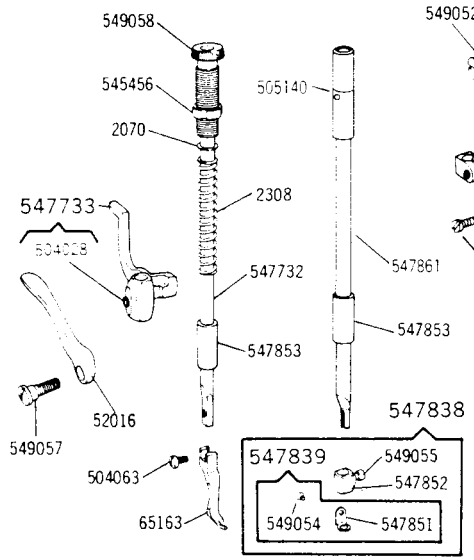
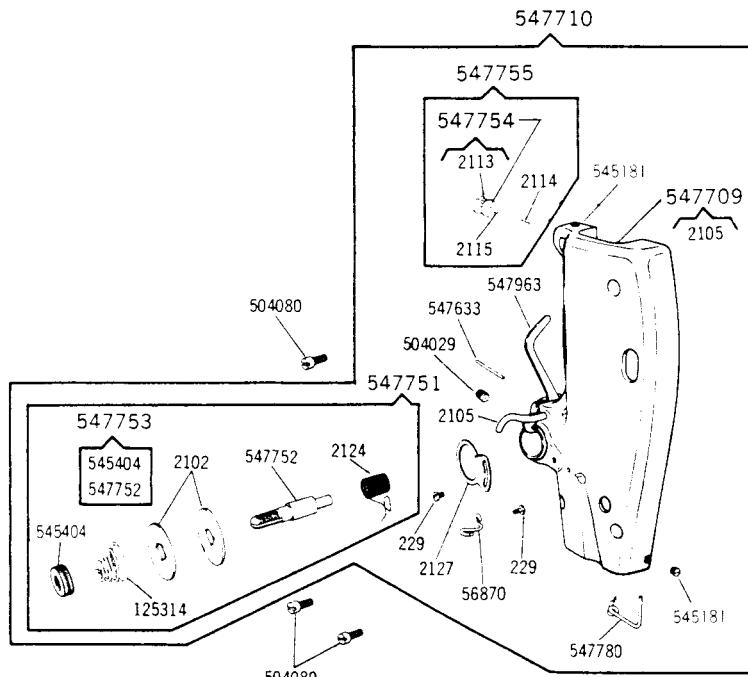
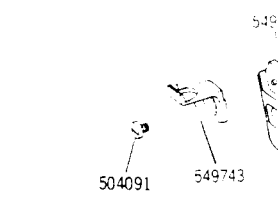
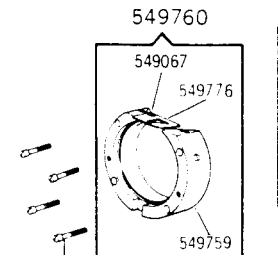
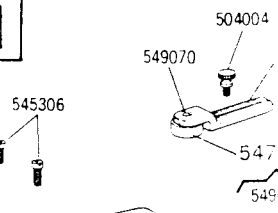
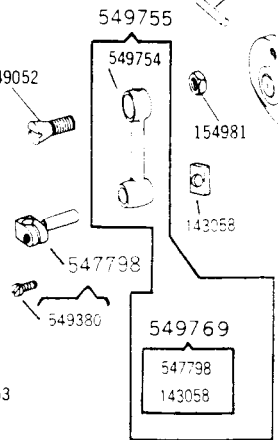
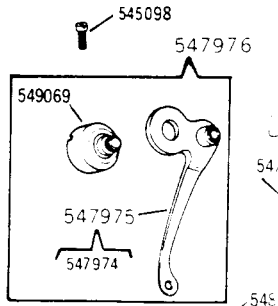

PARTS ONLY FOR MACHINE

17U230/U241

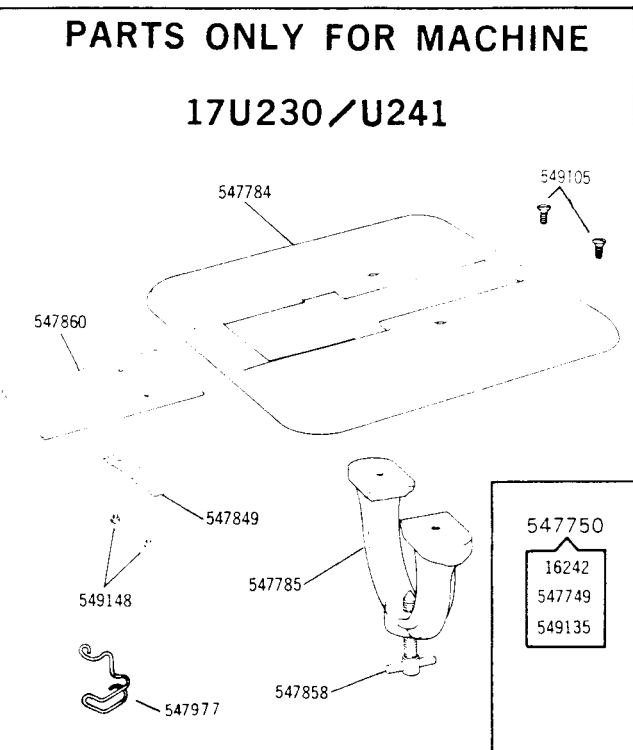

- 16242
- 547749
- 549135

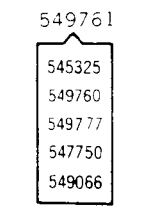
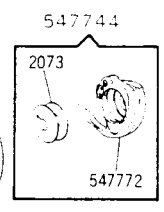
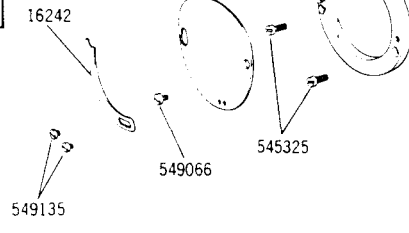

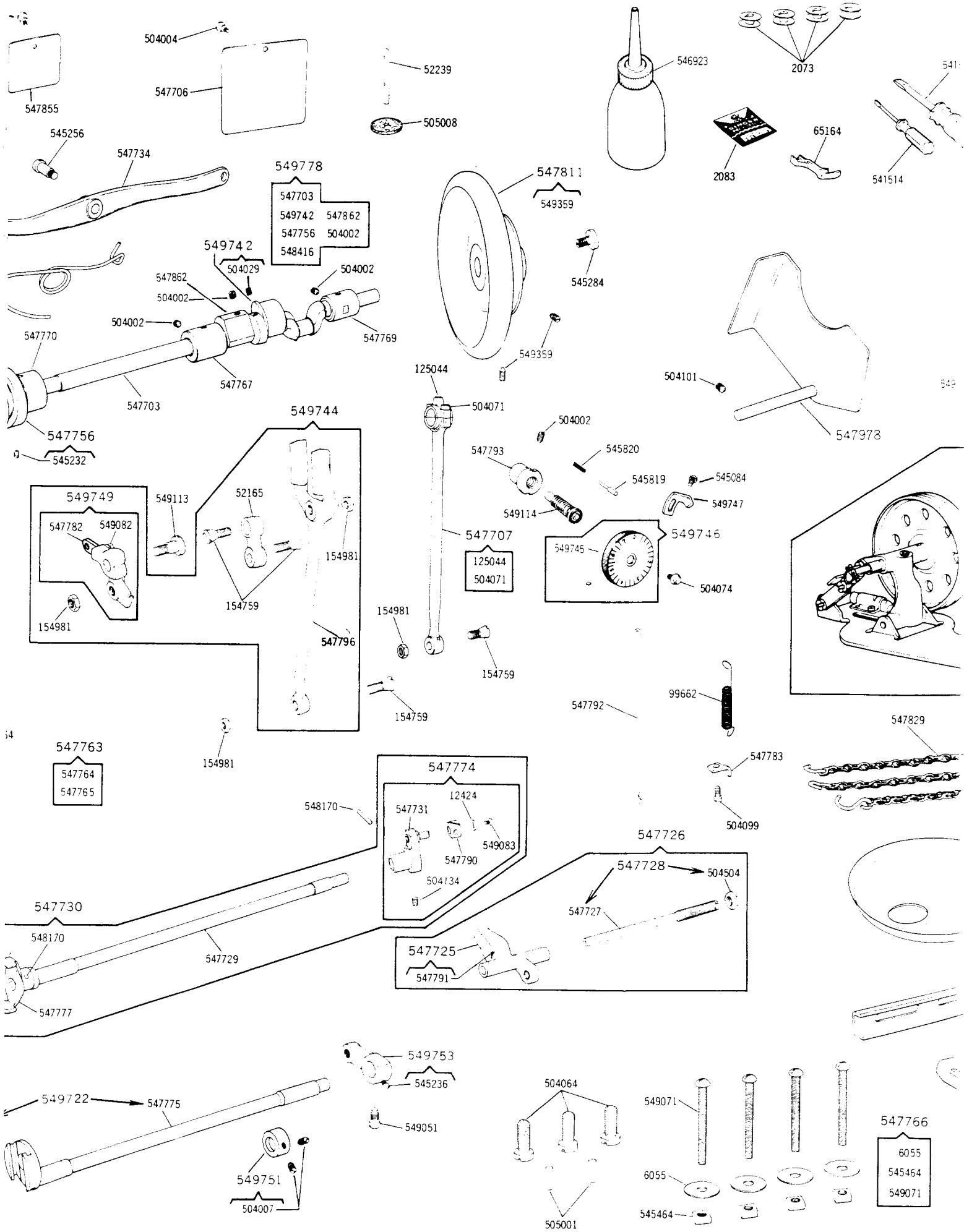

505633

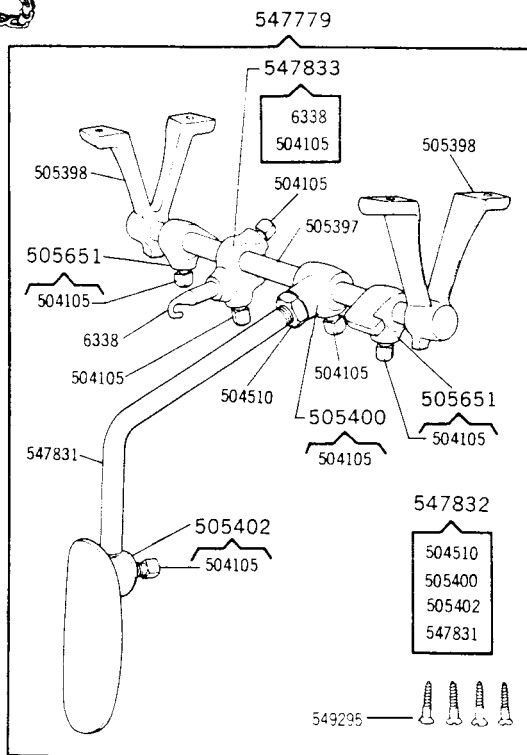
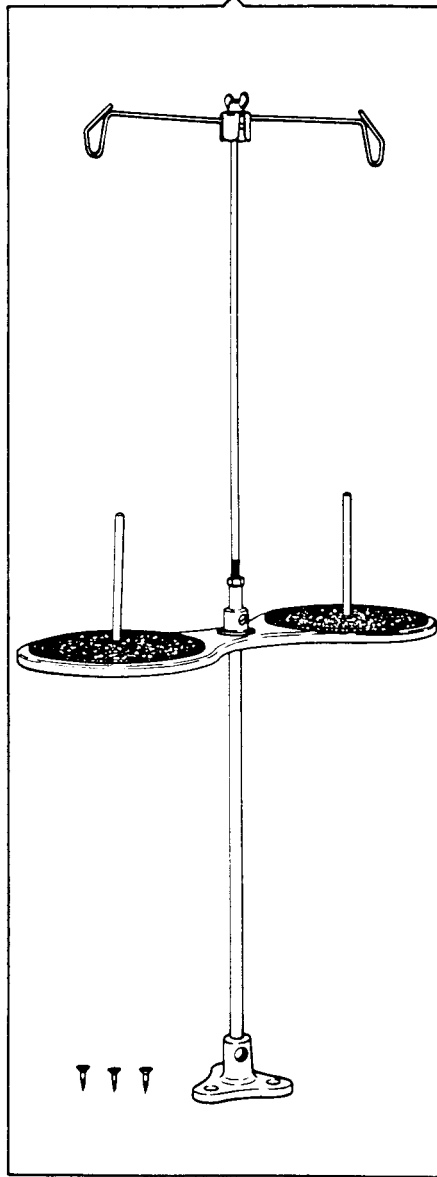
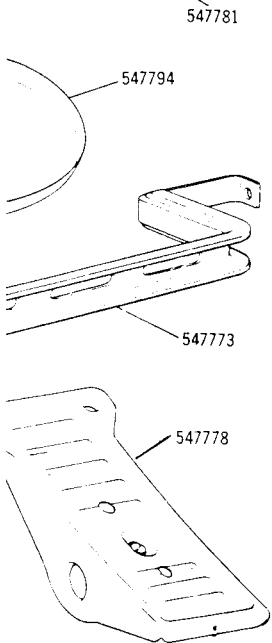
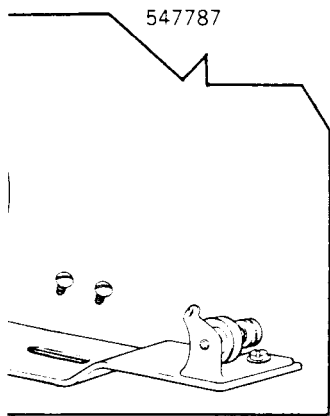
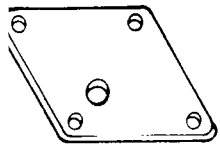
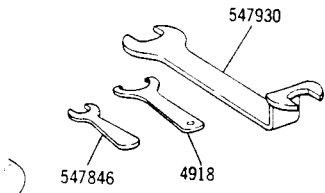

PARTS ONLY FOR MACHINE

17U230

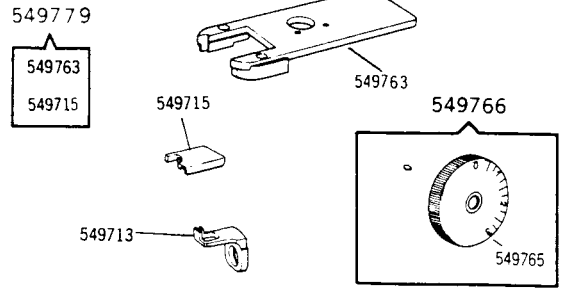

PARTS ONLY FOR MACHINE

17U242

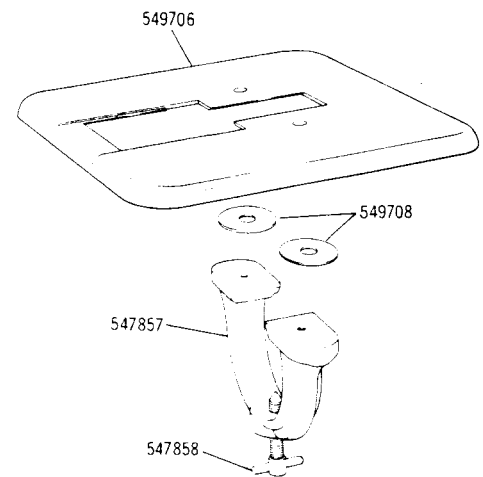
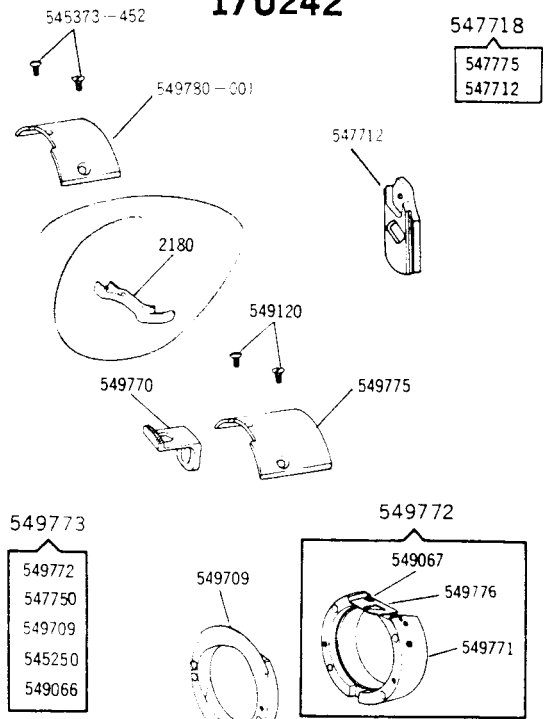

NUMERICAL LIST OF PARTS FOR 17U241, 17U242 AND 17U242 M/C

Part No.	17U			Description	Part No.	17U			Description
	230	241	242			230	241	242	
229	*	*	*	Face Plate Thread Guard (upper) Screw (809)	545236	*	*	*	Feed Rock Shaft Crank Set Screw (803)
					545250	*	*	*	Shuttle Race Ring Screw (2) (803)
229	*	*	*	Thread Take-up Spring Regulator Plate Adjusting Screw (809)	545256	*	*	*	Presser Bar Lifter Lever Hinge Screw (850)
2070	*	*	*	Presser Bar Spring Washer	545284	*	*	*	Arm Shaft Screw (802)
2073	*	*	*	Shuttle Bobbin	545306	*	*	*	Throat Plate Holder Screw (2) (805)
2102	*	*	*	Tension Disc (2)	545325	*	*	*	Shuttle Race Ring Screw (2) (809)
2105	*	*	*	Tension Thread Guard	545404	*	*	*	Tension Regulating Thumb Nut (852)
2113	*	*	*	Thread Retaining Disc Steady Pin	545456	*	*	*	Pressure Regulating Thumb Screw Lock Nut (851)
2114	*	*	*	Thread Retaining Spring					
2115	*	*	*	Thread Retaining Stud	545819	*	*	*	Feed Regulating Stud Lock Pin
2124	*	*	*	Thread Take-up Spring	545820	*	*	*	Feed Regulating Stud Lock Pin Spring
2127	*	*	*	Thread Take-up Spring Regulator Plate	547633	*	*	*	Tension Releaser Hinge Pin
2308	*	*	*	Presser Bar Spring	547703	*	*	*	Arm Shaft
12424	*	*	*	Oscillating Shaft Crank Slide Block Cap Screw Washer	547706	*	*	*	Arm Side Cover
					547707	*	*	*	Crank Connecting Rod with 125044 and two 504071 (833)
16242	*	*	*	Shuttle Race Ring Cover Latch					
52016	*	*	*	Presser Bar Lifter	547709	*	*	*	Face Plate (body) with 2105
52165	*	*	*	Feed Connecting Link	547710	*	*	*	Face Plate complete, Nos. 504029 (833), 56870, 547780, 547755, 2127, 547633, 547963, 547751, 547709 with two each 229 and 545181 (803)
56870	*	*	*	Face Plate Thread Guard (upper)					
65163	*	*	*	Presser Foot (narrow toe)					
99662	*	*	*	Feed Reverse Lever Return Spring	547712	*	*	*	Feed Dog Carrier
125044	*	*	*	Crank Connecting Rod Oil Pad (felt)	547718	*	*	*	Feed Rock Shaft 547775 with 547712
125314	*	*	*	Tension Spring	547725	*	*	*	Oscillating Rock Shaft (body) with 547791
143058	*	*	*	Needle Bar Connecting Stud Slide Block					
154759	*	*	*	Crank Connecting Rod Hinge Screw (850)	547726	*	*	*	Oscillating Rock Shaft complete, Nos. 547725 and 547728
154759	*	*	*	Feed Connecting Link Hinge Screw (2) (850)	547727	*	*	*	Oscillating Rock Shaft Hinge Pin
					547728	*	*	*	Oscillating Rock Shaft Hinge Pin 547727 and 504504 (819)
154759	*	*	*	Feed Forked Connection Hinge Screw (850)	547729	*	*	*	Oscillating Shaft
154961	*	*	*	Crank Connecting Rod Hinge Screw Nut (819)	547730	*	*	*	Oscillating Shaft 547729 with 547724, 547777 and 548170
154981	*	*	*	Feed Connecting Link Hinge Screw Nut (2) (819)	547731	*	*	*	Oscillating Shaft Crank (body) with Screw Stud
154981	*	*	*	Feed Forked Connection Hinge Screw Nut (819)	547732	*	*	*	Presser Bar
					547733	*	*	*	Presser Bar Lifter Bracket with 504028 (850)
154981	*	*	*	Needle Bar Connection Link Hinge Screw Nut (819)	547734	*	*	*	Presser Bar Lifter Lever
504002	*	*	*	Arm Shaft Bushing (intermediate) Set Screw (850)	547744	*	*	*	Shuttle Bobbin 2073 with 547772
504002	*	*	*	Arm Shaft Bushing (back) Set Screw (850)	547749	*	*	*	Shuttle Race Ring Cover
504002	*	*	*	Arm Shaft Counterbalance Set Screw (850)	547752	*	*	*	Shuttle Race Ring Cover 547749 with 16242 and two 549135 (810)
504002	*	*	*	Feed Regulating Stud Bushing Set Screw (850)	547752	*	*	*	Tension complete, Nos. 125314, 2124, 547712 and two 2115
504004	*	*	*	Arm Side Cover Thumb Screw (852)	547754	*	*	*	Tension Screw Stud
504004	*	*	*	Cylinder Side Cover Thumb Screw (852)	547755	*	*	*	Tension Screw Stud 547752 with 549404
504007	*	*	*	Feed Rock Shaft Collar Set Screw (2) (850)	547756	*	*	*	Thread Retaining Disc with 2113
504028	*	*	*	Presser Bar Lifter Bracket Set Screw (850)	547767	*	*	*	Thread Retainer Guide complete, Nos. 547754, 2114 and 2115
504029	*	*	*	Feed Cam Set Screw (850)	547769	*	*	*	Thread Take-up Cam with 545232 (833)
504029	*	*	*	Tension Screw Stud Set Screw (833)	547770	*	*	*	Arm Shaft Bushing (intermediate)
504063	*	*	*	Presser Foot Screw	547771	*	*	*	Arm Shaft Bushing (back)
504063	*	*	*	Roller Presser Screw	547774	*	*	*	Arm Shaft Bushing (front)
504064	*	*	*	Arm Screw (2)					Shuttle Body with Cover
504071	*	*	*	Crank Connecting Rod Cap Screw (2) (833)	547775	*	*	*	Oscillating Shaft Crank complete, Nos. 547731, 547790, 549083 (800), 12424 and 504134 (850)
504074	*	*	*	Feed Regulating Stud Head Cap Screw (850)	547776	*	*	*	Feed Rock Shaft
504080	*	*	*	Face Plate Screw (3) (851)	547777	*	*	*	Presser Bar Lifter Lever Spring
504091	*	*	*	Feed Dog Screw (803)	547778	*	*	*	Shuttle Driver and Feed Lifting Cam
504099	*	*	*	Feed Reverse Lever Return Spring Bracket Screw (1050)	547780	*	*	*	Face Plate Thread Guard (lower)
504101	*	*	*	Belt Safety Guard Shaft Set Screw (830)	547782	*	*	*	Feed Reverse Lever
504134	*	*	*	Oscillating Shaft Crank Set Screw (850)	547783	*	*	*	Feed Reverse Lever Return Spring Bracket
504504	*	*	*	Oscillating Rock Shaft Hinge Pin Lock Nut (819)	547790	*	*	*	Oscillating Shaft Crank Slide Block
505001	*	*	*	Arm Dowel Pin	547791	*	*	*	Oscillating Rock Shaft Oil Pad (felt)
505008	*	*	*	Arm Spool Pin Washer (felt)	547792	*	*	*	Feed Reverse Lever Pitman
505140	*	*	*	Needle Bar Bushing (upper)	547793	*	*	*	Feed Regulating Stud Bushing
543023-001	*	*	*	Roller Presser Complete, (1-1/4 in. fine roller)	547796	*	*	*	Feed Forked Connection
545084	*	*	*	Feed Regulating Stud Head Stopper Screw (853)	547798	*	*	*	Needle Bar Connecting Stud with 549380 (810)
545098	*	*	*	Thread Take-up Lever Hinge Screw Set Screw (850)	547811	*	*	*	Machine Pulley with two 549359 (850)
545181	*	*	*	Face Plate Thread Guard (lower) Screw (803)	547838	*	*	*	Needle Clamp (body) 547852 with 549055 and 547830
545181	*	*	*	Thread Retaining Stud Set Screw (803)	547853	*	*	*	Needle Clamp Thread Guide 547851 with 549054 (851)
545232	*	*	*	Thread Take-up Cam Set Screw (833)	547852	*	*	*	Needle Clamp (body)
					547853	*	*	*	Needle Bar Bushing (lower)
					547853	*	*	*	Presser Bar Bushing
					547855	*	*	*	Cylinder Side Cover
					547861	*	*	*	Needle Bar (narrow)
					547862	*	*	*	Arm Shaft Counterbalance

NUMERICAL LIST OF PARTS FOR 17U241, 17U230 AND 17U242 M/C

Part No.	17U			Description	Part No.	17U			Description
	230	241	242			230	241	242	
547963	*	*	*	Tension Releaser					<u>ACCESSORIES FOR MACHINES 17U230, 17U241, 17U242</u> (Supplied with Machine)
547974	*	*	*	Thread Take-up Lever Roller Stud complete					
547975	*	*	*	Thread Take-up Lever with 547974	CAT. 2083	*	*	*	Needle (size #19) (6)
547976	*	*	*	Thread Take-up Lever 547975 with 549069 (851)	2073	*	*	*	Shuttle Bobbin (4)
547978	*	*	*	Belt Safety Guard with Shaft	2180	*	*	*	Presser Foot
548170	*	*	*	Oscillating Shaft Crank Pin	4918	*	*	*	Wrench (for 545456)
548170	*	*	*	Shuttle Driver Pin	6055	*	*	*	Machine Bolt Washer (4)
548416	*	*	*	Thread Take-up Cam Pin	65164	*	*	*	Presser Foot (wide toe)
549051	*	*	*	Feed Rock Shaft Crank Position Screw (803)	504004	*	*	*	Guide Thumb Screw (809)
549052	*	*	*	Needle Bar Connecting Link Hinge Screw (803)	505656	*	*	*	Thread Unwinder (for two spools) complete (include three wood screws) (purchased assembly)
549054	*	*	*	Needle Clamp Thread Guide Screw (851)	541513	*	*	*	Screw Driver (large)
549055	*	*	*	Needle Clamp Screw	541514	*	*	*	Screw Driver (small)
549057	*	*	*	Presser Bar Lifter Screw (810)	543028-001	*	*	*	Roller Presser complete, (1-1/4 in. fine roller)
549058	*	*	*	Pressure Regulating Thumb Screw	545464	*	*	*	Machine Bolt Nut (4) (809)
549066	*	*	*	Shuttle Race Ring Cover Screw (2) (810)	546923	*	*	*	Oiler (filled with Singer Type "B" Oil)
549067	*	*	*	Shuttle Race Thread Protector Screw (809)	547763	*	*	*	Guide (roller) complete, Nos. 547765 and 547764
549068	*	*	*	Shuttle Race Screw (4) (810)	547764	*	*	*	Guide Bracket
549069	*	*	*	Thread Take-up Lever Hinge Screw (851)	547765	*	*	*	Guide Roller with 549070
549082	*	*	*	Feed Reverse Lever Set Screw (850)	547766	*	*	*	Machine Bolt 549071 with 545464 and 6055 (4)
549083	*	*	*	Oscillating Shaft Crank Slide Block Cap Screw (809)	547773	*	*	*	Motor Treadle Lever
549113	*	*	*	Feed Regulator Hinge Screw (803)	547778	*	*	*	Feed Reversing Treadle complete
549114	*	*	*	Feed Regulating Stud	547781	*	*	*	Feed Reverse Lever Chain
549120	*	*	*	Throat Plate Screw (2) (806)	547787	*	*	*	Universal Bobbin Winder complete, (include two wood screws) (purchased assembly)
549135	*	*	*	Shuttle Race Ring Cover Latch Screw (2) (810)	547791	*	*	*	Crip Pan
549350	*	*	*	Machine Pulley Set Screw (2) (850)	547846	*	*	*	Wrench (for 545454 and 545455)
549380	*	*	*	Needle Bar Connecting Stud Set Screw (803)	547930	*	*	*	Wrench (for 154981)
549709	*	*	*	Shuttle Race Ring	549070	*	*	*	Guide Roller Screw Stud
549710	*	*	*	Feed Dog	549071	*	*	*	Machine Bolt (4) (809)
549714	*	*	*	Feed Dog Carrier	549768	*	*	*	Machine Bed Cushion
549715	*	*	*	Throat Plate					
549722	*	*	*	Feed Rock Shaft 547775 with 549714					
549742	*	*	*	Feed Cam with 504029 (850)					
549743	*	*	*	Feed Dog					
549744	*	*	*	Feed Forked Connection complete, Nos. 547796, 52165, 549749 with two each 154759 and 154981	6338	*	*	*	Rock Shaft Lifting Bracket Hook
549745	*	*	*	Feed Regulating Stud Head	504105	*	*	*	Rock Shaft Knee Arm Hub Set Screw (809)
549746	*	*	*	Feed Regulating Stud Head 549745 with Stop Plate	504105	*	*	*	Rock Shaft Knee Plate Set Screw (809)
549747	*	*	*	Feed Regulating Stud Head Stopper	504105	*	*	*	Rock Shaft Lifting Bracket Hook Set Screw (809)
549749	*	*	*	Feed Regulator with 547782 and 549082 (850)	504105	*	*	*	Rock Shaft Lifting Bracket Set Screw (809)
549751	*	*	*	Feed Rock Shaft Collar with two 504007 (850)	504105	*	*	*	Rock Shaft Stop Dog Set Screw (2) (809)
549753	*	*	*	Feed Rock Shaft Crank with 549076 (803)	504311	*	*	*	Rock Shaft Knee Arm Clamping Nut (809)
549754	*	*	*	Needle Bar Connecting Link	505397	*	*	*	Rock Shaft
549755	*	*	*	Needle Bar Connecting Link 549754 with 549769	505398	*	*	*	Rock Shaft Hanger (2)
549759	*	*	*	Shuttle Race (body)	505400	*	*	*	Rock Shaft Knee Arm Hub with 504105 (809)
549760	*	*	*	Shuttle Race (body) 549759 with 54976 and 549067 (809)	505402	*	*	*	Rock Shaft Knee Plate with 504105 (809)
549761	*	*	*	Shuttle Race complete, Nos. 547750, 549765, 549777 with two each 545325 and 549066	505651	*	*	*	Rock Shaft Stop Dog with 504105 (809) (2)
549763	*	*	*	Throat Plate Holder	547779	*	*	*	Rock Shaft complete Nos. 505397, 547832, 547833, 505651 (2), and 505398 (2) with four Wood Screw (1 in., No. 10)
549765	*	*	*	Feed Regulating Stud Head	547829	*	*	*	Presser Bar Lifter Lever Chain
549766	*	*	*	Feed Regulating Stud Head 549765 with Stop Plate	547831	*	*	*	Rock Shaft Knee Arm
549769	*	*	*	Needle Bar Connecting Stud 547798 with 143053	547832	*	*	*	Rock Shaft Knee Arm complete, Nos. 504310 (809), 547831, 505400 and 505412
549770	*	*	*	Feed Dog	547833	*	*	*	Rock Shaft Lifting Bracket with 6338 and two 504105 (809)
549771	*	*	*	Shuttle Race (body)	549295	*	*	*	Wood Screw (1 in. No. 10) (4)
549772	*	*	*	Shuttle Race (body) 549771 with 549067 (809) and 549776					
549773	*	*	*	Shuttle Race complete, Nos. 549772, 547750, 549709 with two each 549250 and 549066					
549775	*	*	*	Throat Plate					
549776	*	*	*	Shuttle Race Thread Protector					
549777	*	*	*	Shuttle Race Ring					
549778	*	*	*	Arm Shaft 547703 with 549742, 547756, 548416, 547862 and 504002 (850)	547784	*	*	*	Cloth Plate
549779	*	*	*	Throat Plate Holder 549763 and 549715	547785	*	*	*	Cloth Plate Bracket
549782	*	*	*	Throat Plate	547849	*	*	*	Cloth Plate Slide Spring
CAT. 2083	*	*	*	Needle (size #19)	547857	*	*	*	Cloth Plate Bracket
					547858	*	*	*	Cloth Plate Bracket Set Screw with Handle

CLOTH PLATE FOR MACHINES 17U230, 17U241 AND 17U242
(Optional Parts)

NUMERICAL LIST OF PARTS FOR 17U241, 17U242 AND 17U242 M/C

<u>Part No.</u>	<u>17U 17U 17U</u>			<u>Description</u>
	<u>230</u>	<u>241</u>	<u>242</u>	
547860	*	*	*	Cloth Plate Slide
549105	*	*	*	Cloth Plate Screw (2) (850)
549148	*	*	*	Cloth Plate Slide Spring Screw (2) (832)
549706			*	Cloth Plate
549708			*	Cloth Plate Washer
545373-452			*	Throat Plate Screw (2)
547977	*	*		Finger Guard
549780-001			*	Throat Plate