

SINGER

17W1,W2

LIST OF PARTS



MACHINES Nos. 17w1 and 17w2

INDEX

	Page
Accessories.....	22
Binders.....	28
Bobbin Winder.....	22
Feed Dogs.....	24
Knee Lifter.....	23
Machine No. 17w1.....	5
" " 17w2.....	13
Numerical List of Parts.....	31
Presser Feet.....	25
Throat Plates.....	26

INSTRUCTIONS FOR ORDERING

In ordering from this list, use ONLY the PART number in the FIRST column.

The number stamped on a Sewing Machine Part is the number of the Single Part only, except when the part includes Set Screws, Clamping Screws, Studs and Rollers Spun on, Small Wires riveted, or Parts soldered together, etc., which it is necessary to furnish in combination.

Every combination of parts sent out has its specific number which, although not stamped on Parts (except in above case), must be used when ordering the combination.

Each number always indicates the SAME PART in whatever list it appears, or for whatever Machine.

The letters after some of the numbers indicate the style of finish only, as follows:

- A. Hardened, Polished and Plated.
- B. Polished and Plated.
- C. Hardened only.
- D. Polished only.
- E. Soft, not polished.
- F. Hardened and Polished.
- H. Blued.
- J. Nickel Plated only.
- R. Merlized.
- Y. Black Nickel Plated only.

These letters **MUST BE USED** when they appear in the list and **AFTER** the number, as in the list.

In this series

200001 to 201500 and 350001 to 351500 are Screw Numbers.
201501 to 201800 and 351501 to 351800 are Nut Numbers.
201801 to 202000 and 351801 to 352000 are Roller Numbers.
202001 to 350000 are Numbers of Machine Parts.

The figures in the second column refer only to the plate in which the illustration of the part is shown and are **NOT TO BE USED** in ordering.

Two or more numbers over a cut indicate that the difference between such parts is not visible in an illustration.

Parts marked with an asterisk (*) are furnished only when repairs are made at the factory.

LIST OF PARTS COMPLETE

FOR

MACHINE No. 17w1

FOR OVERSEAMING AND ZIGZAG STITCHING

No.	Plate	Name
*204920	-----	Arm with 200439C, 202036 and 204705
204163	12852	" Cap
200278H	12311	" " Screw
202248	12851	" " " Washer
204235	12851	" Position Pin (2)
200963E	12311	" Screw (3)
202005	12851	" " Washer (3)
204291	12854	" Shaft
204705	12852	" " Bushing (front)
200439C	12311	" " " Position Screw
204165	12852	" " Connection with four 200054E (2)
200054E	12851	Arm Shaft Connection Screw
204174	12854	Balance Wheel, 5-1/4 in. diam. (belt groove 2-3/4 in. diam.), with 200328C and 200335C
200062H	12311	Balance Wheel Adjusting Screw
200328C	12311	" " Position Screw
200335C	12311	" " Set Screw
*204872	-----	Bed with 203376, 204245, 204393 and two 200516E
202258	12852	Bed Hinge Connection (2)
200570E	12311	" " " Screw (4)
206105	12852	" Slide (back)
204739	12852	" " (front)
204178	12851	Bobbin
208384	12851	" Case (solid center bearing) with 204181
204181	12851	Bobbin Case Position Finger
204182	12851	" " Tension Spring
200598C	12851	" " " " Regulating Screw
200592C	12851	Bobbin Case Tension Spring Screw
208385	-----	Bobbin Case complete, Nos. 200592C, 200598C 204182 and 208384
200459D	12851	Cloth Guide Thumb Screw
208656	-----	Face Plate with 200366H, 200368H, 202087, 202090, 204185, 204281 and two 200397H
200053C	12311	Face Plate Screw (2)
204185	12851	" " Thread Guide

No.	Plate	Name
200397H	10675	Face Plate Thread Guide Set Screw
208657	12854	Face Plate complete, Nos. 200286F, 200577H, 201527E, 202088, 204059, 204280, 204933, 204934, 206639 and 208656
204875	12852	Feed Bar with 204189
206594	-----	" " 204875 with 200214E, 201525E and 204877
200214E	12851	Feed Bar Hinge Screw
201525E	12851	" " " " Nut
204188	12851	" " Spring
204189	12851	" " Hook
207650	12860	" Dog, for 207394
200106E	12311	" " Screw (2)
210779	-----	" Driving Cam
204191	10662	" " 210779 with 200378C and 200437C
206079	12852	Feed Driving Cam Fork Lever with 204293 and 204928
204193	12852	Feed Driving Cam Fork Lever Connection with 200668C and 201525E
204194	10438	Feed Driving Cam Fork Lever Connection Clamp with 200031F
200031F	12311	Feed Driving Cam Fork Lever Connection Clamp Pinch Screw
200668C	10438	Feed Driving Cam Fork Lever Connection Clamp Screw Stud
201525E	12851	Feed Driving Cam Fork Lever Connection Clamp Screw Stud Nut
200002E	12851	Feed Driving Cam Fork Lever Connection Hinge Screw
201522E	12851	Feed Driving Cam Fork Lever Connection Hinge Screw Nut
*204928	-----	Feed Driving Cam Fork Lever Shaft
204197	10662	" " " " " " Collar with 200113F
200113F	10662	Feed Driving Cam Fork Lever Shaft Collar Set Screw
204293	10662	Feed Driving Cam Fork Lever Shaft Position Pin
204968	10662	Feed Driving Cam Fork Lever Shaft Sleeve (split)
200043C	12311	Feed Driving Cam Fork Lever Shaft Sleeve Set Screw
201524E	12851	Feed Driving Cam Fork Lever Shaft Sleeve Set Screw Nut
206080	-----	Feed Driving Cam Fork Lever complete, Nos. 204194 and 206079
200437C	12311	Feed Driving Cam Position Screw
200378C	12311	" " " Set Screw
204294	12854	" " Rock Shaft

No.	Plate	Name
206555	-----	Feed Driving Rock Shaft 204294 with 200002E, 201522E and 204193
202305	10662	Feed Driving Rock Shaft Center (2)
200043C	12311	" " " " " Set Screw (2)
204877	12853	Feed Driving Rock Shaft Crank with 204189 (on right side) and two 200383C
200383C	12311	Feed Driving Rock Shaft Crank Set Screw
204201	10662	" Lifting Cam Crank with 200335C, 200431C, 200669C and 201530E
200431C	10662	Feed Lifting Cam Crank Position Screw
200335C	12311	" " " " Set Screw
204202	10662	" " " Fork with 200027E
200027E	12851	" " " Pinch Screw
204878	12852	" " Rock Shaft with 204264
204503	-----	" " " 204878 with 201343D and 204204
202305	10662	Feed Lifting Rock Shaft Center (2)
200043C	12311	" " " " " Set Screw (2)
204204	12853	Feed Lifting Rock Shaft Slide Block
201343D	12853	" " " " " Hinge Screw
204264	12853	Feed Lifting Rock Shaft Slide Block Position Pin
204206	12852	Feed Regulating Handle
204207	-----	" " " 204206 with 200098F, 202622, 204208 to 204210, 204213 and 204925
204208	10438	Feed Regulating Handle Adjustable Stop
200098F	10438	" " " " " Screw
204925	10675	Feed Regulating Handle Adjustable Stop Screw Washer
204209	10438	Feed Regulating Handle Position Pin
204210	10438	" " " Shaft
204211	10438	" " " Crank with 200098F
204212	10438	Feed Regulating Handle Shaft Crank Link
200271E	10438	" " " " " Hinge Screw (lower)
200291E	10438	Feed Regulating Handle Shaft Crank Link Hinge Screw (upper)
200098F	10438	Feed Regulating Handle Shaft Crank Set Screw
204213	10438	Feed Regulating Handle Shaft Sleeve (split)
200362C	12311	Feed Regulating Handle Shaft Sleeve Set Screw

PARTS FOR MACHINE NO. 17w1

No.	Plate	Name
202622	10438	Feed Regulating Handle Shaft Sleeve Washer
202036	10438	Feed Regulating Handle Stop Pin
204214	-----	Feed Regulating Handle complete, Nos. 200291E, 204207, 204211 and 204212
204535	12822	Hook (sewing) with 204217
204217	12853	" Bobbin Case Stud
204880	12856	" Bracket with 200379C, two 200380C and three 204234
204881	-----	Hook Bracket 204880 with 204226
204930	-----	" " 204881 with 204224, 204225, 204324, 204539, two each 204223 and 204233
200379C	12853	Hook Bracket Adjusting Screw (lower)
200380C	10884	" " " " (upper)
204539	10458	" " Bobbin Case Stop (hinged)
204223	12853	" " " " " Hinge Pin
204224	12853	" " " " " Latch
204223	12853	" " " " " Hinge Pin
204225	12853	Hook Bracket Bobbin Case Stop Latch Spring
200085C	12853	Hook Bracket Screw (2)
206095	-----	Hook Bracket complete, Nos. 204535 and 204930
204910	12853	Hook Driver with 204242 and 204243
204885	10514	" " Bevel Gear, 25 teeth, with two 200348C
200348C	10514	Hook Driver Bevel Gear Set Screw
208246	-----	" " Crank
204240	12855	" " 208246 with 200378C, 200662C, 201530E and two 200348C
204241	10662	Hook Driver Crank Link
200669C	12853	" " " " Stud
201530E	12853	" " " " Nut
200348C	10514	" " " Set Screw (long)
200378C	12311	" " " " (short)
200662C	12853	" " " Stud
201530E	12853	" " " Nut
204243	12853	" " Pin
204242	12855	" " Washer
204887	10514	" Driving Bevel Gear (intermediate), 24 teeth
204888	12856	Hook Driving Bevel Gear (intermediate) Bracket
206078	10514	Hook Driving Bevel Gear (intermediate) Bracket 204888 with 200772C, 201516E and 204887
200041E	10514	Hook Driving Bevel Gear (intermediate) Bracket Screw (2)

PARTS FOR MACHINE NO. 17w1

No.	Plate	Name
200772C	10514	Hook Driving Bevel Gear (intermediate) Bracket Screw Stud
201516E	12855	Hook Driving Bevel Gear (intermediate) Bracket Screw Stud Nut
204890	12856	Hook Driving Bevel Gear (intermediate) Oil Guard
200113F	10662	Hook Driving Bevel Gear (intermediate) Oil Guard Screw (2)
204886	10514	Hook Driving Bevel Gear Shaft, 25 teeth
204393	12855	" " " " " Bushing
206104	12854	" " Shaft
204245	12856	" " " Bearing
202126	12855	" " " " Position Pin
200516E	12311	" " " " Screw
204246	10662	" " " Collar with two 200383C
200383C	12311	" " " Set Screw
204226	12822	" Race, .156 in. thick, 1.906 in. diameter
204324	10457	Hook Race Cap (steel)
204230	12855	" " " Spring
204233	12855	" " " " 204230 with 200802E
200802E	12855	" " " " Screw
204234	12855	" " Position Pin
237837	12854	Knee Lifter Connection Lever
208506	-----	" " " " 237837 with 208507, 227308 and two 200262H
200262H	12855	Knee Lifter Connection Lever Hinge Screw
227308	12856	" " " " Lifting Rod with 202302
202302	12855	Knee Lifter Connection Lever Lifting Rod Cotter Pin
208507	12854	Knee Lifter Lifting Lever
200262H	12855	" " " " Hinge Screw
208613	-----	Needle Bar (hollow)
204247	12857	" " 208613 with 200125F, 200175D and 204250
204911	12855	Needle Bar Connecting Link
200237C	12855	" " " " Hinge Screw Stud
201519E	12855	Needle Bar Connecting Link Hinge Screw Stud Nut
206024	12855	Needle Bar Connecting Stud with two 200387C
200387C	12855	Needle Bar Connecting Stud Set Screw
204913	12856	" " Frame
204916	12856	" " " Driving Cam with two 200347C
204917	12856	Needle Bar Frame Driving Cam Cover
200571B	12855	" " " " " Screw (3)
204918	12855	Needle Bar Frame Driving Cam Follower

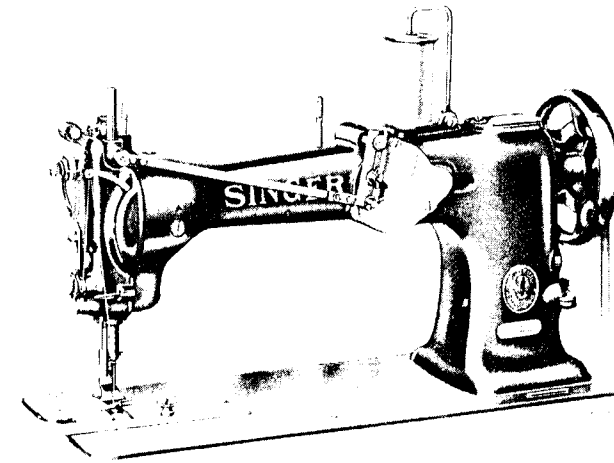
No.	Plate	Name
200347C	12855	Needle Bar Frame Driving Cam Set Screw
204919	12857	" " " Pitman with 200741C, 201531E,204921 and two 200110B
200741C	12855	Needle Bar Frame Pitman Ball Screw
*204921	-----	" " " " " " Cap
200110B	12855	" " " " " " " Screw
201531E	12855	Needle Bar Frame Pitman Ball Screw Nut
204922	12858	" " " " Connection (ad- justable)
204841	-----	Needle Bar Frame Pitman Connection 204922 with 204923
204926	-----	Needle Bar Frame Pitman Connection 204841 with 204919,204924 and two 200110B
204923	12858	Needle Bar Frame Pitman Connection Bearing
204924	12858	Needle Bar Frame Pitman Connection Clamp Washer
200110B	12855	Needle Bar Frame Pitman Connection Clamp Washer Screw
200791E	12858	Needle Bar Frame Pitman Connection Slide
206505	12858	" " " " " " Stop
202108	12858	Needle Bar Frame Pitman Connection Slide Stop Pin
200135C	12858	Needle Bar Frame Pitman Connection Slide Stop Screw
225908	12858	Needle Bar Frame Pitman Connection Slide Stop Screw Washer
228026	10884	Needle Bar Frame Pitman Connection Slide Washer
201581B	12858	Needle Bar Frame Pitman Connection Slide Wing Nut
204944	-----	Needle Bar Frame Pitman Connection com- plete, Nos. 200791E,201581B,204926 and 228026
204929	12856	Needle Bar Frame Regulator with 202090 202108 and 204928
*204928	-----	Needle Bar Frame Regulator Shaft
202574	10662	" " " " " Collar with 200380C
200380C	10884	Needle Bar Frame Regulator Shaft Collar Set Screw
202090	10675	Needle Bar Frame Regulator Shaft Pin
200410C	12858	" " " " Screw Center (lower or upper)
201517E	10514	Needle Bar Frame Screw Center Nut (lower or upper)
204250	12858	Needle Bar Thread Guide

No.	Plate	Name
200175D	12858	Needle Bar Thread Guide Screw
200125F	12858	" Set Screw
204251	12857	Presser Bar (hollow) with 200074F
204252	12858	" " Lifter
200550C	12311	" " " Hinge Screw
208609	12858	" " Lifting Bracket
204931	-----	" " " " 208609 with 200650F and 201525E
204254	12858	Presser Bar Lifting Bracket Position Guide
200362C	12311	Presser Bar Lifting Bracket Position Guide Set Screw
204327	-----	Presser Bar Packing Washer (felt)
200504E	12858	" " Screw Bushing (lower)
204255	12858	" " Spring
200491B	12858	" " Thumb Screw (pressure regu- lating)
207187	12862	Presser Foot
200074F	12859	" " Screw
202068	12857	Spool Holder Base
200575H	12311	" " " Screw
204296	12857	" " Wire
200079H	12311	" " " Hinge Screw
204297	12857	Spool Holder complete, Nos.200079H,202068 and 204296
204969	12857	Take-up Cam with 200237C,200335C,200383C 200430C,201519E and 204911
203172	12859	Take-up Cam Friction Washer
200430C	12311	" " Position Screw
200383C	12311	" " " " Check Screw
200335C	12311	" " Set Screw
204262	12859	" Lever
206556	-----	" " 204262 with 204263
204263	12859	" " Bearing with 204264
204264	12853	" " " Position Pin
200042F	12311	" " " Screw
201816	12859	" " Roller
204266	-----	Take-up Lever complete, Nos.200042F, 201816 and 206556
244048	10675	Tension Disc
202090	10675	" " Position Pin
204933	12859	" Release Lever
200286F	12859	" " " Hinge Screw
201527E	12859	" " " " " Nut
204934	12859	" " " " " Washer
200650F	12859	" " " Switch Screw Stud
201525E	12851	" " " " " " Nut

No.	Plate	Name
202407	10881	Tension Spring
200632B	10675	" Stud
200397H	10675	" " Set Screw
201572B	10881	" Thumb Nut
204271	10675	" Washer
206639	10675	Tension complete, Nos. 200632B, 201572B, 202407, 204271 and two 244048
204274	10675	Thread Controller Plate
200577H	12311	" " " Screw
202098	10675	" " Roller
204275	10675	" " " Guard
202084	10675	" " " Washer
200300C	10675	" " " Screw
204276	10675	" " Spring
204333	10675	" " " Guard
200581H	10675	" " " " Screw
202087	10675	" " " Stop
202088	10675	" " " Stud with 204925
200366H	10675	" " " " Set Screw
204925	10675	" " " " Washer
205987	10675	Thread Controller complete, Nos. 200300C, 200581H, 202084, 202098, 204274, 204275 and 204333
204280	10675	Thread Controller and Spring complete, Nos. 204276 and 205987
204459	12859	Thread Guide
202412	12859	" "
204281	10675	" Retainer Guide Wire
202091	10675	" " Sleeve
202092	10675	" " Spring
204058	10675	" " Stud
200368H	10675	" " " Set Screw
204059	10675	Thread Retainer complete, Nos. 202091, 202092 and 204058
207394	12866	Throat Plate, 53 needle hole, for needle sizes 12 and 13, for 207650
203376	12859	Throat Plate Position Pin
200577H	12311	" " Screw

LIST OF PARTS COMPLETE

FOR



MACHINE No. 17w2

FOR OVERSEAMING AND ZIGZAG STITCHING

No.	Plate	Name
*215773	-----	Arm with 200439C, 202036 and 206101
204163	12852	" Cap
200278H	12311	" " Screw
202248	12851	" " " Washer
204235	12851	" Position Pin (2)
200963E	12311	" Screw (3)
202005	12851	" " Washer (3)
204291	12854	" Shaft
206101	12852	" " Bushing (front)
200439C	12311	" " " Position Screw
204165	12852	" " Connection with four 200054E (2)
200054E	12851	Arm Shaft Connection Screw
204174	12854	Balance Wheel, 5-1/4 in. diam. (belt groove 2-3/4 in. diam.), with 200328C and 200335C
200062H	12311	Balance Wheel Adjusting Screw
200329C	12311	" " Position Screw

No.	Plate	Name
200335C	12311	Balance Wheel Set Screw
*204872	-----	Bed with 203376,204245,204393 and two 200516E
202258	12852	Bed Hinge Connection (2)
200570E	12311	" " " Screw (4)
206105	12852	" Slide (back)
204739	12852	" " (front)
204178	12851	Bobbin
208382	12851	" Case (solid center bearing) with 204181
204181	12851	Bobbin Case Position Finger
204531	12851	" " Tension Spring
200598C	12851	" " " " Regulating Screw
200592C	12851	Bobbin Case Tension Spring Screw
208383	-----	Bobbin Case complete, Nos. 200592C, 200598C 204531 and 208382
200459D	12851	Cloth Guide Thumb Screw
208656	-----	Face Plate with 200366H, 200368H, 202087, 202090, 204185, 204281 and two 200397H
200053C	12311	Face Plate Screw (2)
204185	12851	" " Thread Guide
200397H	10675	" " " " Set Screw
208657	12854	Face Plate complete, Nos. 200286F, 200577H, 201527E, 202088, 204059, 204280, 204933, 204934, 206639 and 208656
204875	12852	Feed Bar with 204189
206594	-----	" " 204875 with 200214E, 201525E and 204877
200214E	12851	Feed Bar Hinge Screw
201525E	12851	" " " " Nut
204188	12851	" " Spring
204189	12851	" " Hook
207649	10632	" Dog, for 207397
200106E	12311	" " Screw (2)
210779	-----	" Driving Cam
204191	10662	" " " 210779 with 200378C and 200437C
206079	12852	Feed Driving Cam Fork Lever with 204293 and 204928
204193	12852	Feed Driving Cam Fork Lever Connection with 200668C and 201525E
204194	10438	Feed Driving Cam Fork Lever Connection Clamp with 200031F
200031F	12311	Feed Driving Cam Fork Lever Connection Clamp Pinch Screw
200668C	10438	Feed Driving Cam Fork Lever Connection Clamp Screw Stud
201525E	12851	Feed Driving Cam Fork Lever Connection Clamp Screw Stud Nut

No.	Plate	Name
200002E	12851	Feed Driving Cam Fork Lever Connection Hinge Screw
201522E	12851	Feed Driving Cam Fork Lever Connection Hinge Screw Nut
*204928	-----	Feed Driving Cam Fork Lever Shaft
204197	10662	" " " " " " Collar with 200113F
200113F	10662	Feed Driving Cam Fork Lever Shaft Collar Set Screw
204293	10662	Feed Driving Cam Fork Lever Shaft Posi- tion Pin
204968	10662	Feed Driving Cam Fork Lever Shaft Sleeve (split)
200043C	12311	Feed Driving Cam Fork Lever Shaft Sleeve Set Screw
201524E	12851	Feed Driving Cam Fork Lever Shaft Sleeve Set Screw Nut
206080	-----	Feed Driving Cam Fork Lever complete, Nos. 204194 and 206079
200437C	12311	Feed Driving Cam Position Screw
200378C	12311	" " " Set Screw
204294	12854	" " Rock Shaft
206555	-----	" " " " 204294 with 200002E 201522E and 204193
202305	10662	Feed Driving Rock Shaft Center (2)
200043C	12311	" " " " " Set Screw (2)
204877	12853	Feed Driving Rock Shaft Crank with 204189 (on right side) and two 200383C
200383C	12311	Feed Driving Rock Shaft Crank Set Screw
204201	10662	" Lifting Cam Crank with 200335C, 200431C, 200669C and 201530E
200431C	10662	Feed Lifting Cam Crank Position Screw
200335C	12311	" " " " Set Screw
204202	10662	" " " Fork with 200027E
200027E	12851	" " " " Pinch Screw
204878	12852	" " Rock Shaft with 204264
204503	-----	" " " " 204878 with 201343D and 204204
202305	10662	Feed Lifting Rock Shaft Center (2)
200043C	12311	" " " " " Set Screw (2)
204204	12853	Feed Lifting Rock Shaft Slide Block
201343D	12853	" " " " " " Hinge Screw
204264	12853	Feed Lifting Rock Shaft Slide Block Position Pin
204206	12852	Feed Regulating Handle
204207	-----	" " " 204206 with 200098F 202622, 204208 to 204210, 204213 and 204925

No.	Plate	Name
204208	10438	Feed Regulating Handle Adjustable Stop
200098F	10438	" " " " "
		Screw
204925	10675	Feed Regulating Handle Adjustable Stop
		Screw Washer
204209	10438	Feed Regulating Handle Position Pin
204210	10438	" " " Shaft
204211	10438	" " " " Crank with
		200098F
204212	10438	Feed Regulating Handle Shaft Crank Link
200271E	10438	" " " " " "
		Hinge Screw (lower)
200291E	10438	Feed Regulating Handle Shaft Crank Link
		Hinge Screw (upper)
200098F	10438	Feed Regulating Handle Shaft Crank Set
		Screw
204213	10438	Feed Regulating Handle Shaft Sleeve
		(split)
200362C	12311	Feed Regulating Handle Shaft Sleeve Set
		Screw
202622	10438	Feed Regulating Handle Shaft Sleeve
		Washer
202036	10438	Feed Regulating Handle Stop Pin
204214	-----	Feed Regulating Handle complete, Nos.
		200291E, 204207, 204211 and 204212
204935	12822	Hook (sewing) with 204217
204217	12853	" Bobbin Case Stud
204936	10458	" Bracket with 200379C, two 200380C and
		204234
204937	-----	Hook Bracket 204936 with 204941
204938	-----	" " 204937 with 204224, 204225,
		204539, 204942, two each 204223 and
		204231
200379C	12853	Hook Bracket Adjusting Screw (lower)
200380C	10884	" " " " (upper)
204539	10458	" " Bobbin Case Stop (hinged)
204223	12853	" " " " Hinge Pin
204224	12853	" " " " Latch
204223	12853	" " " " " Hinge
		Pin
204225	12853	Hook Bracket Bobbin Case Stop Latch
		Spring
200085C	12853	Hook Bracket Screw (C)
204939	10457	Hook Bracket complete, Nos. 204935 and
		204938
204940	12853	Hook Driver with 204242 and 204243
204885	10514	" " Bevel Gear, 25 teeth, with two
		200348C
200348C	10514	Hook Driver Bevel Gear Set Screw
208246	-----	" " Crank

No.	Plate	Name
204240	12855	Hook Driver Crank 208246 with 200378C,
		200662C, 201530E and two 200348C
204241	10662	Hook Driver Crank Link
200669C	12853	" " " " Stud
201530E	12853	" " " " Nut
200348C	10514	" " " Set Screw (long)
200378C	12311	" " " " (short)
200662C	12853	" " " Stud
201530E	12853	" " " " Nut
204243	12853	" " Pin
204242	12855	" " Washer
204887	10514	" Driving Bevel Gear (intermediate),
		24 teeth
204888	12856	Hook Driving Bevel Gear (intermediate)
		Bracket
206078	10514	Hook Driving Bevel Gear (intermediate)
		Bracket 204888 with 200772C, 201516E
		and 204887
200041E	10514	Hook Driving Bevel Gear (intermediate)
		Bracket Screw (2)
200772C	10514	Hook Driving Bevel Gear (intermediate)
		Bracket Screw Stud
201516E	12855	Hook Driving Bevel Gear (intermediate)
		Bracket Screw Stud Nut
204890	12856	Hook Driving Bevel Gear (intermediate)
		Oil Guard
200113F	10662	Hook Driving Bevel Gear (intermediate)
		Oil Guard Screw (2)
204886	10514	Hook Driving Bevel Gear Shaft, 25 teeth
204393	12855	" " " " Bushing
206104	12854	" " Shaft
204245	12856	" " Bearing
202126	12855	" " " " Position Pin
200516E	12311	" " " " Screw
204246	10662	" " " Collar with two 200383C
200383C	12311	" " " " Set Screw
204941	12856	" Race, .156 in. thick, 1.906 in. diam-
		eter
204942	10458	Hook Race Cap (iron)
202230	12855	" " " Spring
204231	12855	" " " " 204230 with 200792E
200792E	12855	" " " " Screw
204234	12855	" " Position Pin
237837	12854	Knee Lifter Connection Lever
208506	-----	" " " " 237837 with
		208507, 227308 and two 200262H
200262H	12855	Knee Lifter Connection Lever Hinge Screw
227308	12856	" " " " Lifting Rod
		with 202302

No.	Plate	Name
202302	12855	Knee Lifter Connection Lever Lifting Rod Cotter Pin
208507	12854	Knee Lifter Lifting Lever
200262H	12855	" " " " Hinge Screw
208613	-----	Needle Bar (hollow)
204247	12857	" " 208613 with 200125F, 200175D and 204250
204911	12855	Needle Bar Connecting Link
200237C	12855	" " " " Hinge Screw Stud
201519E	12855	Needle Bar Connecting Link Hinge Screw Stud Nut
206024	12855	Needle Bar Connecting Stud with two 200387C
200387C	12855	Needle Bar Connecting Stud Set Screw
204913	12856	" " Frame
204916	12856	" " " Driving Cam with two 200347C
204917	12856	Needle Bar Frame Driving Cam Cover
200571B	12855	" " " " " " Screw (3)
204918	12855	Needle Bar Frame Driving Cam Follower
200347C	12855	" " " " " Set Screw
204919	12857	" " " Pitman with 200741C, 201531E, 204921 and two 200110B
200741C	12855	Needle Bar Frame Pitman Ball Screw
*204921	-----	" " " " " " Cap
200110B	12855	" " " " " " " " Screw
201531E	12855	Needle Bar Frame Pitman Ball Screw Nut
204922	12858	" " " " " Connection (ad- justable)
204841	-----	Needle Bar Frame Pitman Connection 204922 with 204923
204926	-----	Needle Bar Frame Pitman Connection 204841 with 204919, 204924 and two 200110B
204923	12858	Needle Bar Frame Pitman Connection Bear- ing
204924	12858	Needle Bar Frame Pitman Connection Clamp Washer
200110B	12855	Needle Bar Frame Pitman Connection Clamp Washer Screw
204943	10514	Needle Bar Frame Pitman Connection Slide (double) with two 200330E
200330E	10514	Needle Bar Frame Pitman Connection Slide Screw
206505	12858	Needle Bar Frame Pitman Connection Slide Stop

No.	Plate	Name
200135C	12858	Needle Bar Frame Pitman Connection Slide Stop Screw
225908	12858	Needle Bar Frame Pitman Connection Slide Stop Screw Washer
228026	10884	Needle Bar Frame Pitman Connection Slide Washer
201581B	12858	Needle Bar Frame Pitman Connection Slide Wing Nut
204945	-----	Needle Bar Frame Pitman Connection com- plete, Nos. 204926, 204943, two each 201581B and 228026
206102	12856	Needle Bar Frame Regulator with 202090 and 204928
*204928	-----	Needle Bar Frame Regulator Shaft
202374	10662	" " " " " Collar with 200380C
200380C	10884	Needle Bar Frame Regulator Shaft Collar Set Screw
202090	10675	Needle Bar Frame Regulator Shaft Pin
200410C	12858	" " " Screw Center (lower or upper)
201517E	10514	Needle Bar Frame Screw Center Nut (lower or upper)
204250	12858	Needle Bar Thread Guide
200175D	12858	" " " " " Screw
200125F	12858	" Set Screw
204251	12857	Presser Bar (hollow) with 200074F
204252	12858	" " Lifter
200550C	12311	" " " Hinge Screw
208609	12858	" " Lifting Bracket
204931	-----	" " " " 208609 with 200650F and 201525E
204254	12858	Presser Bar Lifting Bracket Position Guide
200362C	12311	Presser Bar Lifting Bracket Position Guide Set Screw
204327	-----	Presser Bar Packing Washer (felt)
200504E	12858	" " Screw Bushing (lower)
204255	12858	" " Spring
200491B	12858	" " Thumb Screw (pressure regu- lating)
207120	12863	Presser Foot
200074F	12859	" " " Screw
202068	12857	Spool Holder Base
200575H	12311	" " " Screw
204296	12857	" " Wire
200079H	12311	" " " Hinge Screw
204297	12857	Spool Holder complete, Nos. 200079H, 202068 and 204296

No.	Plate	Name
204969	12857	Take-up Cam with 200237C, 200335C, 200383C 200430C, 201519E and 204911
200430C	12311	Take-up Cam Position Screw
200383C	12311	" " " " Check Screw
200335C	12311	" " Set Screw
204262	12859	" Lever
206556	-----	" " 204262 with 204263
204263	12859	" " Bearing with 204264
204264	12853	" " " Position Pin
200042F	12311	" " " Screw
201816	12859	" " Roller
204266	-----	Take-up Lever complete, Nos. 200042F, 201816 and 206556
244048	10675	Tension Disc
202090	10675	" " Position Pin
204933	12859	" Release Lever
200286F	12859	" " " Hinge Screw
201527E	12859	" " " " Nut
204934	12859	" " " " Washer
200650F	12859	" " " Switch Screw Stud
201525E	12851	" " " " " "
		Nut
202407	10881	Tension Spring
200632B	10675	" Stud
200397H	10675	" " Set Screw
201572B	10881	" Thumb Nut
204271	10675	" Washer
206639	10675	Tension complete, Nos. 200632B, 201572B, 202407, 204271 and two 244048
204274	10675	Thread Controller Plate
200577H	12311	" " " Screw
202098	10675	" " Roller
204275	10675	" " " Guard
202084	10675	" " " Washer
200300C	10675	" " " Screw
204276	10675	" " Spring
204333	10675	" " " Guard
200581H	10675	" " " Screw
202087	10675	" " " Stop
202088	10675	" " " Stud with 204925
200366H	10675	" " " Set Screw
204925	10675	" " " Washer
205987	10675	Thread Controller complete, Nos. 200300C 200581H, 202084, 202098, 204274, 204275 and 204333
204280	10675	Thread Controller and Spring complete, Nos. 204276 and 205987
202412	12859	Thread Guide
204281	10675	" Retainer Guide Wire
202091	10675	" " Sleeve

No.	Plate	Name
202092	10675	Thread Retainer Spring
204058	10675	" " Stud
200368H	10675	" " " Set Screw
204059	10675	Thread Retainer complete, Nos. 202091, 202092 and 204058
207397	10632	Throat Plate, 50 needle hole, for needle sizes 14 and 15, for 207649
203376	12859	Throat Plate Position Pin
200577H	12311	" " Screw

Genuine Singer Needles should be used
in Singer Machines.
These Needles and their Containers
are marked with the
Company's Trade Mark "SIMANCO." 1

Needles in Containers marked
"For Singer Machines"
are not Singer made needles. 2

ACCESSORIES

FOR MACHINE No. 17w1

No.	Plate	Name
204178	12851	Bobbin (5)
*225482	-----	" Case Screw Driver Blade
*225483	-----	" " " " Handle
225497	10776	Bobbin Case Screw Driver complete, Nos. 225482 and 225483
231337	12859	Cloth Guide
130 x 17	-----	Needles, six, size 14
228216	-----	Drip Pan with four 1 in. wire nails
41400	10776	Machine Rest Pin (wood)
120342	10776	Oiler (copper plated) with 120343
120343	10776	" Spout, 3-1/2 in. long
*225484	-----	Screw Driver Blade
*225485	-----	" " Handle
225498	10776	Screw Driver complete (7-1/4 in. long), Nos. 225484 and 225485
225554	10776	Wrench (steel)

BOBBIN WINDER

(SWINGING AUTOMATIC, RIGHT HAND)

225453	10884	Frame with 202277 and 225438
225454	10884	" Hinge Pin
202277	-----	" Oil Packing (wick)
225438	10884	" " Well Cap
225455	10884	" Spring
225456	10884	" " Plunger
202473	10885	Pulley with 200380C
200380C	10884	" Set Screw
225381	10884	Spindle
225444	10884	Stop Latch
200056E	10884	" " Screw
225458	10884	" " Thumb Lever
225459	10884	" " " " Hinge Stud
225459	10884	" " " " Joint Stud
202478	10884	" " Trip Lever
200299H	10884	" " " " Hinge Screw
225461	10881	Tension Bracket with 201499B
200082D	10881	" " Screw
228026	10884	" " " Washer

No.	Plate	Name
2102	10881	Tension Disc
202407	10881	" Spring
201499B	10881	" Stud
201572B	10881	" " Thumb Nut
225462	10881	Tension Bracket complete, Nos. 201572B, 202407, 225461 and two 2102
225433	10885	Bobbin Winder and Tension Bracket Base
225302	10885	Universal Bobbin Winder complete, Nos. 200056E, 200082D, 200299H, 202473, 202478, 225301, 225433, 225444, 225453 to 225456, 225458, 225462, 228026, two each 225459 and wood screws 3/4 in., No. 12, R.H.B.

KNEE LIFTER

228294	15911	Rock Lever with two 356C
228295	15911	" " Bracket with 356C and four wood screws 7/8 in., No. 12
228299	-----	Rock Lever Bracket 228295 with 228294 and 228297
226296	15911	Rock Lever Extension with 200529C
356C	15911	" " " Set Screw
228297	15911	" " Hinge Pin
356C	15911	" " " Set Screw
228284	15911	" " Knee Plate with 356C
202455	15911	" " " " Arm
356C	15911	" " " " Set Screw
356C	15911	" " " " Set Screw
227728	15911	" " Rod with 227729
*227729	-----	" " " Cap
200529C	15911	" " " Set Screw
228298	15911	Knee Lifter complete, Nos. 202455, 227728, 228284, 228296 and 228299

(Other Knee Lifter parts are listed with parts of machine head.)

FOR MACHINE No. 17w2

Same as for No. 17w1 with the following exception:
130 x 19 ----- Needles, six, size 14, in place of 130x17

FEED DOGS

No.	Plate	Name
206083	12860	Feed Dog, for 206088, 206089, 206094 and 207406
207620	12861	Feed Dog, for 226247 and 226252
207621	12860	" " " 207396 to 207399
207622	12861	" " " 207493
207625	12860	" " " 207494
207638	12861	" " " 207495
207639	12861	" " " 207456 and 207491
207643	12860	" " " 207393, 207395, 207405, 207415 and 207492
207644	12861	Feed Dog, for 207371
207648	12861	" " " 207388
207649	10632	" " " 207396 to 207399
207650	12860	" " " 207394
207652	12860	" " " 206088, 206089, 206094 and 207406
207654	12860	Feed Dog, for 207409
207659	12861	" " " 207501
207675	12860	" " " 207447
207691	12861	" " " 207500
226250	12861	" " " 226248 and 226251
230605	12861	" " " 230604

Genuine Singer Needles should be used
in Singer Machines.
These Needles and their Containers
are marked with the
Company's Trade Mark "SIMANCO." 1

Needles in Containers marked
"For Singer Machines"
are not Singer made needles. 2

PRESSER FEET

FOR MACHINE No. 17w1

No.	Plate	Name
207142	12863	Presser Foot
207184	12863	" "
207164	12863	" "
230590	12863	" "
207131	12863	" " for binding
207187	12862	" "
207132	12863	" "
207120	12863	" "
207118	12863	" "
202090	10675	" " Hinge Pin
207159	-----	" " Plate
210620	-----	" " Shank
207160	12862	Presser Foot (hinged) complete, Nos. 202090, 207159 and 210620
207021	10645	Presser Foot with 204006
204006	12859	" " Position Pin

FOR MACHINE No. 17w2

207133	12862	Presser Foot
207187	12862	" "
207120	12863	" "
207181	12862	" "
207105	12862	" "
206099	12862	" " 40 needle hole

THROAT PLATES

FOR MACHINE No. 17w1

No.	Plate	Name
207501	12832	Throat Plate,56 needle hole,for needle sizes 10 and 11, for 207659
207395	12866	Throat Plate,50 needle hole,for needle sizes 14 and 15,for stitching selvage edges together with a flat seam,for 207643
207492	12865	Throat Plate,35 needle hole,for needle sizes 25 and 26 for 207643
207415	12864	Throat Plate,53 needle hole,for needle sizes 12 and 13, for 207643
207393	12864	Throat Plate,50 needle hole,for needle sizes 14 and 15, for 207643
207494	12865	Throat Plate,53 needle hole,for needle sizes 12 and 13,for 207625
207447	12867	Throat Plate,60 needle hole,for needle sizes 8 and 9, for 207675
207394	12866	Throat Plate,53 needle hole,for needle sized 12 and 13,for 207650
207409	12865	Throat Plate,50 needle hole,for needle sizes 14 and 15, for 207654
207493	12865	Throat Plate,60 needle hole,for needle sizes 8 and 9,for 207622
207371	12831	Throat Plate,50 needle hole,for needle sizes 14 and 15,for 207644
207388	12831	Throat Plate,53 needle hole,for needle sizes 12 and 13, for 207648
207491	12831	Throat Plate,50 needle hole,for needle sizes 14 and 15,for 207639
226247	12867	Throat Plate,50 needle hole,for needle sizes 14 and 15, for binding, for 207620 and 226978
230604	12832	Throat Plate,50 needle hole,for needle sizes 14 and 15,for 230605
207401	-----	Throat Plate,50 needle hole,for needle sizes 14 and 15,with two 207404 .for suspender ends,for 207405
207402	10645	Throat Plate Guide (left)
207403	10645	" " " (right)
207404	10645	" " " Position Pin
200482D	10645	" " " Thumb Screw
207405	10645	Throat Plate complete,50 needle hole for needle sizes 14 and 15,Nos. 207401 to 207403 and two 200482D. for 207643

FOR MACHINE No. 17w2

No.	Plate	Name
207397	10632	Throat Plate,50 needle hole, for needle sizes 14 and 15, for 207621 and 207396
207649	10632	Throat Plate,60 needle hole,for needle sizes 8 and 9,for 207621 and 207649
207398	10632	Throat Plate,53 needle hole,for needle sizes 12 and 13,for stitching selvage edges together with a flat seam,for 207621 and 207649
207399	10632	Throat Plate,60 needle hole,for needle sizes 8 and 9,for 207621 and 207649
207406	12866	Throat Plate,56 needle hole,for needle sizes 10 and 11,for 206083 and 207652
206088	12864	Throat Plate,50 needle hole,for needle sizes 14 and 15, for 206083 and 207652
206089	12864	Throat Plate,46 needle hole,for needle sizes 16 and 18,for 206083 and 207652
206094	12832	Throat Plate,50 needle hole,for needle sizes 14 and 15, for 206083 and 207652
207456	12831	Throat Plate,50 needle hole,for needle sizes 14 and 15,for 207639
207495	12867	Throat Plate (thick stock),50 needle hole,for needle sizes 14 and 15,for 207638
207500	12866	Throat Plate,46 needle hole,for needle sizes 16 and 18,for 207691
226248	12867	Throat Plate,50 needle hole,for needle sizes 14 and 15,for binding,for 226250 and 226979

Genuine Singer Needles should be used
in Singer Machines.
These Needles and their Containers
are marked with the
Company's Trade Mark "SIMANCO." 1

Needles in Containers marked
"For Singer Machines"
are not Singer made needles. 2

BINDERS

WHEN ORDERING BINDERS STATE SIZE REQUIRED. SEND
SAMPLE OF BINDING AND MATERIAL TO BE BOUND

FOR AWNING WORK

No.	Plate	Name
230124	12868	Binder Head, for tapes of various widths
230125	12857	" Swing Bracket with seven 225648
226074	12857	" " " Base
200922B	12868	" " " " Hinge Screw
201527H	12859	" " " " " " Nut
200463D	12868	" Thumb Screw
225648	12868	" Tape Tension Pin
230262	-----	Binder complete, Nos. 200922B, 201527H, 226074, 230124, 230125 and two 200463D
230605	12861	Feed Dog
230604	12832	Throat Plate, 50 needle hole, for needle sizes 14 and 15
230590	12863	Presser Foot

Note: Nos. 230590, 230604 and 230605 should be
used with, but are not included in
230262.

FOR MACHINE No. 17w1

259119	12868	Binder Head, for tapes from 1/4 to 1 in., in steps of 1/32 inch
200155F	12868	Binder Screw
207620	12861	Feed Dog
207105	12862	Presser Foot
226247	12867	Throat Plate, 50 needle hole, for needle sizes 14 and 15
226978	-----	Throat Plate 226247 with 200155F and 259119
226252	-----	Binder complete, Nos. 207105, 207620 and 226978

FOR MACHINE No. 17w2

No.	Plate	Name
230577	12868	Binder Head, for tapes or folded strips of different widths as follows: 7/16, 1/2, 9/16, 5/8 and 3/4 inch
200154F	12868	Binder Screw
226250	12861	Feed Dog
207105	12862	Presser Foot
226248	12867	Throat Plate, 50 needle hole, for needle sizes 14 and 15
226979	-----	Throat Plate 226248 with 200154F and 230577
226251	-----	Binder complete, Nos. 207105, 226250 and 226979

Genuine Singer Needles should be used
in Singer Machines.
These Needles and their Containers
are marked with the
Company's Trade Mark "SIMANCO." 1

Needles in Containers marked
"For Singer Machines"
are not Singer made needles. 2

NUMERICAL LIST OF PARTS

NUMERICAL LIST OF PARTS

FOR

MACHINES

Nos. 17w1 and 17w2

No.	Plate	Name
356C	15911	Knee Lifter Rock Shaft Lever Extension Set Screw, for 228294
356C	15911	Knee Lifter Rock Lever Hinge Pin Set Screw, for 228295
356C	15911	Knee Lifter Rock Lever Knee Plate Arm Set Screw, for 228294
356C	15911	Knee Lifter Rock Lever Knee Plate Set Screw, for 228294
2102	10881	Bobbin Winder Tension Disc, for 225462
41400	19776	Machine Rest Pin (wood)
120342	10776	Oiler (copper plated) with 120343
120343	10776	" Spout, 3-1/2 in. long, for 120342
200002E	12851	Feed Driving Cam Fork Lever Connection Hinge Screw, for 206555
200027E	12851	Feed Lifting Cam Fork Pinch Screw, for 204202
200031F	12311	Feed Driving Cam Fork Lever Connection Clamp Pinch Screw, for 204194
200041E	10514	Hook Driving Bevel Gear (intermediate) Bracket Screw
200042F	12311	Take-up Lever Bearing Screw, for 204206
200043C	12311	Feed Driving Cam Fork Lever Shaft Sleeve Set Screw
200043C	12311	Feed Driving Rock Shaft Center Set Screw
200043C	12311	" Lifting Rock Shaft Center Set Screw
200053C	12311	Face Plate Screw
200054E	12851	Arm Shaft Connection Screw, for 204165
200056E	10884	Bobbin Winder Stop Latch Screw, for 225382
200062H	12311	Balance Wheel Adjusting Screw
200074F	12859	Presser Foot Screw, for 204251
200079H	12311	Spool Holder Wire Hinge Screw, for 204297
200082D	10881	Bobbin Winder Tension Bracket Screw, for 225382
200085C	12853	Hook Bracket Screw
200098F	10438	Feed Regulating Handle Adjustable Stop Screw, for 204207
200098F	10438	Feed Regulating Handle Shaft Crank Set Screw, for 204211
200106E	12311	Feed Dog Screw
200110B	12855	Needle Bar Frame Pitman Ball Screw Cap Screw, for 204919

NUMERICAL LIST OF PARTS

No.	Plate	Name
200110B	12855	Needle Bar Frame Pitman Connection Clamp Washer Screw, for 204926
200113F	10662	Feed Driving Cam Fork Lever Shaft Collar Set Screw, for 204197
200113F	10662	Hook Driving Bevel Gear (intermediate) Oil Guard Screw
200125F	12858	Needle Set Screw, for 204247
200135C	12858	" Bar Frame Pitman Connection Slide Stop Screw
200154F	12868	Binder Screw, for 226979
200155F	12868	" " " 226978
200175D	12858	Needle Bar Thread Guide Screw, for 204247
200214E	12851	Feed Bar Hinge Screw, for 206594
200237C	12855	Needle Bar Connecting Link Hinge Screw Stud, for 204969
200262H	12855	Knee Lifter Connection Lever Hinge Screw for 208506
200262H	12855	Knee Lifter Lifting Lever Hinge Screw, for 208506
200271E	10438	Feed Regulating Handle Shaft Crank Link Hinge Screw (lower)
200278H	12311	Arm Cap Screw
200286F	12859	Tension Release Lever Hinge Screw, for 208657
200291E	10438	Feed Regulating Handle Shaft Crank Link Hinge Screw (upper), for 204214
200299H	10884	Bobbin Winder Stop Latch Trip Lever Hinge Screw, for 225382
200300C	10675	Thread Controller Roller Screw, for 205987
200328C	12311	Balance Wheel Position Screw, for 204174
200330E	10514	Needle Bar Frame Pitman Connection Slide Screw, for 204943
200335C	12311	Balance Wheel Set Screw, for 204174
200335C	12311	Feed Lifting Cam Crank Set Screw, for 204201
200335C	12311	Take-up Cam Set Screw, for 204969
200347C	12855	Needle Bar Frame Driving Cam Set Screw, for 204916
200348C	10514	Hook Driver Bevel Gear Set Screw, for 204885
200348C	10514	Hook Driver Crank Set Screw (long), for 204240
200362C	12311	Feed Regulating Handle Shaft Sleeve Set Screw
200362C	12311	Presser Bar Lifting Bracket Position Guide Set Screw
200366H	10675	Thread Controller Spring Stud Set Screw, for 208656

NUMERICAL LIST OF PARTS

No.	Plate	Name
200366H	10675	Thread Retainer Stud Set Screw, for 208656
200378C	12311	Feed Driving Cam Set Screw, for 204191
200378C	12311	Hook Driver Crank Set Screw (short), for 204240
200379C	12853	Hook Bracket Adjusting Screw (lower), for 204880 and 204936
200380C	10884	Bobbin Winder Pulley Set Screw, for 202473
200380C	10884	Hook Bracket Adjusting Screw (upper), for 204880 and 204936
200380C	10884	Needle Bar Frame Regulator Shaft Collar Set Screw, for 202574
200383C	12311	Feed Driving Rock Shaft Crank Set Screw, for 204877
200383C	12311	Hook Driving Shaft Collar Set Screw, for 204246
200383C	12311	Take-up Cam Position Screw Check Screw, for 204969
200387C	12855	Needle Bar Connecting Stud Set Screw, for 206024
200397H	10675	Face Plate Thread Guide Set Screw, for 208656
200397H	10675	Tension Stud Set Screw, for 208656
200410C	12858	Needle Bar Frame Screw Center (lower or upper)
200430C	12311	Take-up Cam Position Screw, for 204969
200431C	10662	Feed Lifting Cam Crank Position Screw, for 204201
200437C	12311	Feed Driving Cam Position Screw, for 204191
200439C	12311	Arm shaft Bushing Position Screw, for 204920 and 215773
200459D	12851	Cloth Guide Thumb Screw
200463D	12868	Binder Thumb Screw, for 230262
200482D	10645	Throat Plate Guide Thumb Screw, for 207405
200491B	12858	Presser Bar Thumb Screw (pressure regulating)
200504E	12858	Presser Bar Screw Bushing (lower)
200516E	12311	Hook Driving Shaft Bearing Screw, for 204872
200529C	15911	Knee Lifter Rock Lever Rod Set Screw, for 228296
200550C	12311	Presser Bar Lifter Hinge Screw
200570E	12311	Bed Hinge Connection Screw
200571B	12855	Needle Bar Frame Driving Cam Cover Screw
200575H	12311	Spool Holder Base Screw
200577H	12311	Thread Controller Plate Screw, for 208657
200577H	12311	Throat Plate Screw

No.	Plate	Name
200581H	10675	Thread Controller Spring Guard Screw, for 205927
200592C	12851	Bobbin Case Tension Spring Screw, for 208383 and 208385
200598C	12851	Bobbin Case Tension Spring Regulating Screw, for 208383 and 208385
200632B	10675	Tension Stud, for 206639
200650F	12859	" Release Lever Switch Screw Stud, for 204931
200662C	12853	Hook Driver Crank Stud, for 204240
200668C	10438	Feed Driving Cam Fork Lever Connection Clamp Screw Stud, for 204193
200669C	12853	Hook Driver Crank Link Stud, for 204201
200741C	12855	Needle Bar Frame Pitman Ball Screw, for 204919
200772C	10514	Hook Driving Bevel Gear (intermediate) Bracket Screw Stud, for 206078
200791E	12858	Needle Bar Frame Pitman Connection Slide for 204944
200792E	12855	Hook Race Cap Spring Screw, for 204231
200802E	12855	" " " " " " 204233
200922B	12868	Binder Swing Bracket Base Hinge Screw, for 230262
200963E	12311	Arm Screw
201343D	12853	Feed Lifting Rock Shaft Slide Block Hinge Screw, for 204503
201499B	10881	Bobbin Winder Tension Stud, for 225461
201516E	12855	Hook Driving Bevel Gear (intermediate) Bracket Screw Stud Nut, for 206078
201517E	10514	Needle Bar Frame Screw Center Nut (lower or upper)
201519E	12855	Needle Bar Connecting Link Hinge Screw Stud Nut, for 204969
201522E	12851	Feed Driving Cam Fork Lever Connection Hinge Screw Nut, for 206555
201524E	12851	Feed Driving Cam Fork Lever Shaft Sleeve Set Screw Nut
201525E	12851	Feed Bar Hinge Screw Nut, for 206594
201525E	12851	" Driving Cam Fork Lever Connection Clamp Screw Stud Nut, for 204193
201525E	12851	Tension Release Lever Switch Screw Stud Nut, for 204931
201527H	12859	Binder Swing Bracket Base Hinge Screw Nut, for 230262
201527E	12859	Tension Release Lever Hinge Screw Nut, for 208657
201530E	12853	Hook Driver Crank Link Stud Nut, for 204201
201530E	12853	Hook Driver Crank Stud Nut, for 204240

No.	Plate	Name
201531E	12855	Needle Bar Frame Pitman Ball Screw Nut, for 204919
201572B	10881	Bobbin Winder Tension Stud Thumb Nut, for 225462
201572B	10881	Tension Thumb Nut, for 206639
201581B	12858	Needle Bar Frame Pitman Connection Slide Wing Nut, for 204944 and 204945
201816	12859	Take-up Lever Roller, for 204266
202005	12851	Arm Screw Washer
202036	10438	Feed Regulating Handle Stop Pin, for 204920 and 215773
202068	12857	Spool Holder Base, for 204297
202084	10675	Thread Controller Roller Guard Washer, for 205987
202087	10675	Thread Controller Spring Stop, for 208656
202088	10675	" " " Stud with 208657
202090	10675	Needle Bar Frame Regulator Shaft Pin, for 204929 and 206102
202090	10675	Presser Foot Hinge Pin, for 207160
202090	10675	Tension Disc Position Pin, for 208656
202091	10675	Thread Retainer Sleeve, for 204059
202092	10675	" " Spring, for 204059
202098	10675	" Controller Roller, for 205987
202108	12858	Needle Bar Frame Pitman Connection Slide Stop Pin, for 204929
202126	12855	Hook Driving Shaft Bearing Position Pin
202248	12851	Arm Cap Screw Washer
202258	12852	Bed Hinge Connection
202277	-----	Bobbin Winder Frame Oil Packing (wick), for 225453
202302	12855	Knee Lifter Connection Lever Lifting Rod Cotter Pin, for 227308
202305	10662	Feed Driving Rock Shaft Center
202305	10662	" Lifting Rock Shaft Center
202407	10881	Bobbin Winder Tension Spring, for 225462
202407	10881	Tension Spring, for 206639
202412	12859	Thread Guide
202455	15911	Knee Lifter Rock Lever Knee Plate Arm, for 228298
202473	10885	Bobbin Winder Pulley with 200380C, for 225332
202478	10884	Bobbin Winder Stop Latch Trip Lever, for 225332
202574	10662	Needle Bar Frame Regulator Shaft Collar with 200380C
202622	10438	Feed Regulating Handle Shaft Sleeve Washer, for 204207
203172	12859	Take-up Cam Friction Washer, for Machine No. 17w1
203376	12859	Throat Plate Position Pin, for 204872

No.	Plate	Name
204006	12859	Presser Foot Position Pin,for 207021
204058	10675	Thread Retainer Stud,for 204059
204059	10675	Thread Retainer complete,Nos.202091, 202092 and 204058,for 208657
204163	12852	Arm Cap
204165	12852	" Shaft Connection with four 200054E
204174	12854	Balance Wheel,5-1/4 in. diam. (belt groove 2-3/4 in. diam.),with 200328C and 200335C
204178	12851	Bobbin
204181	112851	" Case Position Finger,for 208382 and 208384
204182	12851	Bobbin Case Tension Spring,for 208385
204185	12851	Face Plate Thread Guide,for 208656
204188	12851	Feed Bar Spring
204189	12851	" " " Hook,for 204875 and 204877
204191	10662	Feed Driving Cam 210779 with 200378C and 200437C
204193	12852	Feed Driving Cam Fork Lever Connection with 200668C and 201525E,for 206555
204194	10438	Feed Driving Cam Fork Lever Connection Clamp with 200031F,for 206080
204197	10662	Feed Driving Cam Fork Lever Shaft Collar with 200113F
204201	10662	Feed Lifting Cam Crank with 200335C, 200431C,200669C and 201530E
204202	10662	Feed Lifting Cam Fork with 200027E
204204	12853	" " Rock Shaft Slide Block,for 204503
204206	12852	Feed Regulating Handle,for 204207
204207	-----	" " " 204206 with 200098F 202622,204208 to 204210,204213 and 204925,for 204214 Nos.204208 to 204210,for 204207
204208	10438	Feed Regulating Handle Adjustable Stop
204209	10438	" " " Position Pin
204210	10438	" " " Shaft
204211	10438	" " " Crank with 200098F,for 204214
204212	10438	Feed Regulating Handle Shaft Crank Link for 204214
204213	10438	Feed Regulating Handle Shaft Sleeve (split), for 204207
204214	-----	Feed Regulating Handle complete,Nos. 200291E,204207,204211 and 204212
204217	12853	Hook Bobbin Case Stud,for 204535 and 204935 Nos. 204223 to 204225,for 204930 and 204938
204223	12853	Hook Bracket Bobbin Case Stop Hinge Pin

No.	Plate	Name
204223	12853	Hook Bracket Bobbin Case Stop Latch Hinge Pin
204224	12853	Hook Bracket Bobbin Case Stop Latch
204225	12853	" " " " " " " Spring
204226	12822	" Race,.156 in. thick,1.906 in. diam., for 204881
204230	12855	Hook Race Cap Spring,for 204231 and 204233
204231	12855	Hook Race Cap Spring 204230 with 200792E for 204938
204233	12855	Hook Race Cap Spring 204230 with 200902E for 204930
204234	12855	Hook Race Position Pin,for 204880 and 204936
204235	12851	Arm Position Pin
204240	12855	Hook Driver Crank 208246 with 200378C, 200662C,201530E and two 200348C
204241	10662	Hook Driver Crank Link
204242	12855	" " Washer,for 204910 and 204940
204243	12853	" " Pin,for 204910 and 204940
204245	12856	" Driving Shaft Bearing,for 204872
204246	10662	" " " Collar with two 200383C
204247	12857	Needle Bar 208613 with 200125F,200175D and 204250
204250	12858	Needle Bar Thread Guide,for 204247
204251	12857	Presser Bar (hollow) with 200074F
204252	12858	" " Lifter
204254	12858	" " Lifting Bracket Position Guide
204255	12858	Presser Bar Spring
204262	12859	Take-up Lever,for 206556
204263	12859	" " Bearing with 204264,for 206556
204264	12853	Feed Lifting Rock Shaft Slide Block Position Pin,for 204878
204264	12853	Take-up Lever Bearing Position Pin,for 204263
204266	-----	Take-up Lever complete,Nos.200042F, 201916 and 206556
204271	10675	Tension Washer,for 206639
204274	10675	Thread Controller Plate,for 205987
204275	10675	" " Roller Guard,for 205987
204276	10675	" " Spring,for 204280
204280	10675	Thread Controller and Spring complete, Nos.204276 and 205987,for 208657
204281	10675	Thread Retainer Guide Wire,for 208656
204291	12854	Arm Shaft
204293	10662	Feed Driving Cam Fork Lever Shaft Posi- tion Pin,for 206079
204294	12854	Feed Driving Rock Shaft,for 206555

No.	Plate	Name
204296	12857	Spool Holder Wire, for 204297
204297	12857	Spool Holder complete, Nos. 200079H, 202068 and 204296
204324	10457	Hook Race Cap(steel), for 204930
204327	-----	Presser Bar Packing Washer (felt)
204333	10675	Thread Controller Spring Guard, for 205987
204393	12855	Hook Driving Bevel Gear Shaft Bushing, for 204872
204459	12859	Thread Guide, for Machine No.17w1
204503	-----	Feed Lifting Rock Shaft 204878 with 201343D and 204204
204531	12851	Bobbin Case Tension Spring, for 208383
204535	12822	Hook (sewing) with 204217, for 206095
204539	10458	" Bracket Bobbin Case Stop (hinged), for 204930 and 204938
204705	12852	Arm Shaft Bushing (front), for 204920
204739	12852	Bed Slide (front)
204841	-----	Needle Bar Frame Pitman Connection 204922 with 204923, for 204926
*204872	-----	Bed with 203376, 204245, 204393 and two 200516E
204875	12852	Feed Bar with 2004189, for 206594
204877	12853	" Driving Rock Shaft Crank with 204189 (on right side) and two 200383C, for 206594
204878	12852	Feed Lifting Rock Shaft with 204264, for 204503
204880	12856	Hook Bracket with 200379C, two 200380C and three 204234, for 204881
204881	-----	Hook Bracket 204880 with 204226, for 204930
204885	10514	Hook Driver Bevel Gear, 25 teeth, with two 200348C
204886	10514	Hook Driving Bevel Gear Shaft, 25 teeth
204887	10514	" " " " (intermediate), 24 teeth, for 206078
204888	12856	Hook Driving Bevel Gear (intermediate) Bracket, for 206078
204890	12856	Hook Driving Bevel Gear (intermediate) Oil Guard
204910	12853	Hook Driver with 204242 and 204243, for Machine No.17w1
204911	12855	Needle Bar Connecting Link, for 204969
204913	12856	" " Frame
204916	12856	" " " Driving Cam with two 200347C
204917	12856	Needle Bar Frame Driving Cam Cover
204918	12855	" " " " " Follower

No.	Plate	Name
204919	12857	Needle Bar Frame Pitman with 200741C, 201531E, 204921 and two 200110B, for 204926
*204920	-----	Arm with 200439C, 202036 and 204705, for Machine No.17w1
*204921	-----	Needle Bar Frame Pitman Ball Screw Cap, for 204919
204922	12858	Needle Bar Frame Pitman Connection (adjustable), for 204841
204923	12858	Needle Bar Frame Pitman Connection Bearing, for 204841
204924	12858	Needle Bar Frame Pitman Connection Clamp Washer, for 204926
204925	10675	Feed Regulating Handle Adjustable Stop Screw Washer, for 204207
204925	10675	Thread Controller Spring Stud Washer, for 202088
204926	-----	Needle Bar Frame Pitman Connection 204841 with 204919, 204924 and two 200110B, for 204944 and 204945
*204928	-----	Feed Driving Cam Fork Lever Shaft, for 206079
*204928	-----	Needle Bar Frame Regulator Shaft, for 204929 and 206102
204929	12856	Needle Bar Frame Regulator with 202090, 202108 and 204928, for Machine No.17w1
204930	-----	Hook Bracket 204881 with 204224, 204225, 204324, 204539, two each 204223 and 204233, for 206095
204931	-----	Presser Bar Lifting Bracket 208609 with 200650F and 201525E
204933	12859	Tension Release Lever, for 2008657
204934	12859	" " " Hinge Screw Washer, for 208657
204935	12859	Hook (sewing) with 204217, for 204939
204936	10458	" Bracket with 200379C, two 200380C and three 204234, for 204937
204937	-----	Hook Bracket 204936 with 204941, for 204938
204938	-----	Hook Bracket 204937 with 204224, 204225, 204539, 204942, two each 204223 and 204231, for 204939
204939	10457	Hook Bracket complete, Nos. 204935 and 204938, for Machine No. 17w2
204940	12853	Hook Driver with 204242 and 204243, for Machine No. 17w2
204941	12856	Hook Race, .156 in. thick, 1.906 in. diam., for 204937
204942	10458	Hook Race Cap (iron), for 204938

No.	Plate	Name
207399	10632	Throat Plate,60 needle hole,for needle sizes 8 and 9 Nos.207401 to 207403,for 207405
207401	-----	Throat Plate,50 needle hole,for needle sizes 14 and 15,with two 207404,for suspender ends
207402	10645	Throat Plate Guide (left)
207403	10645	" " " (right)
207404	10645	" " " Position Pin,for 207401
207405	10645	Throat Plate complete,50 needle hole,for needle sizes 14 and 15,Nos.207401 to 207403 and two 200482D,for 207643,for Machine No.17w1
207406	12866	Throat Plate,56 needle hole,for needle sizes 10 and 11,for 206083 and 207652 for Machine No.17w2
207409	12865	Throat Plate,50 needle hole,for needle sizes 14 and 15,for 207654,for Machine No.17w1
207415	12864	Throat Plate,53 needle hole,for needle sizes 12 and 13,for 207643,for Machine No.17w1
207447	12867	Throat Plate,60 needle hole,for needle sizes 8 and 9,for 207675,for Machine No.17w1
207456	12831	Throat Plate,50 needle hole,for needle sizes 14 and 15,for 207639,for Machine No.17w2 Nos.207491 to 207494,for Machine No.17w1
207491	12831	Throat Plate,50 needle hole,for needle sizes 14 and 15,for 207639
207492	12865	Throat Plate,35 needle hole,for needle sizes 25 and 26,for 207643
207493	12865	Throat Plate,60 needle hole,for needle sizes 8 and 9,for 207622
207494	12865	Throat Plate,53 needle hole,for needle sizes 12 and 13,for 207625
207495	12867	Throat Plate (thick stock),50 needle hole,for needle sizes 14 and 15, for 207638,for Machine No.17w2
207500	12866	Throat Plate,46 needle hole,for needle sizes 16 and 18,for 207691,for Machine No.17w2
207501	12832	Throat Plate,56 needle hole,for needle sizes 10 and 11,for 207659,for Machine No.17w1
207620	12861	Feed Dog,for 226247 and 226252
207621	12860	" " " 207396 to 207399
207622	12861	" " " 207493
207625	12860	" " " 207494

No.	Plate	Name
207638	12861	Feed Dog,for 207459
207639	12661	" " " 207456 and 207495
207643	12860	" " " 207393,207395,207405,207415 and 207492
207644	12861	Feed Dog,for 207371
207648	12861	" " " 207388
207649	10632	" " " 207396 to 207399
207650	12860	" " " 207394
207652	12860	" " " 206088,206089,206094 and 207406
207654	12860	Feed Dog,for 207409
207659	12861	" " " 207501
207675	12860	" " " 207447
207691	12861	" " " 207500
208246	-----	Hook Driver Crank,for 204240
208382	12851	Bobbin Case (solid center bearing),with 204181,for 208383
208383	-----	Bobbin Case complete,Nos.200592C,200598C 204531 and 208382,for Machine No.17w2
208384	12851	Bobbin Case (solid center bearing) with 204181,for 208385
208385	-----	Bobbin Case complete,Nos.200592C,200598C 204182 and 208384,for Machine No.17w1
208506	-----	Knee Lifter Connection Lever 237837 with 208507,227308 and two 200262H
208507	12854	Knee Lifter Lifting Lever,for 208506
208609	12858	Presser Bar Lifting Bracket,for 204931
208613	-----	Needle Bar (hollow),for 204247
208656	-----	Face Plate with 200366H,200368H,202087, 202090,204185,204281 and two 200397H, for 208657
208657	12854	Face Plate complete,Nos.200286F,200577H, 201527E,202088,204059,204280,204933, 204934,206639 and 208656
210620	-----	Presser Foot Shank,for 207160
210779	-----	Feed Driving Cam,for 204191
*215773	-----	Arm with 200439C,202036 and 206101,for Machine No. 17w2
225381	10884	Bobbin Winder Spindle,for 225382
225382	10885	Universal Bobbin Winder complete,Nos. 200056E,200082D,200299H,202473,202478, 225381,225433,225444,225453 to 225456 225458,225462,228026,two each 225459 and wood screws 3/4 in.,No.12,R.H.B.
225433	10885	Bobbin Winder and Tension Bracket Base, for 225382
225438	10884	Bobbin Winder Frame Oil Well Cap,for 225453
225444	10884	Bobbin Winder Stop Latch,for 225382

No.	Plate	Name
225453	10884	Nos.225453 to 225456,for 225382 Bobbin Winder Frame with 202277 and 225438
225454	10884	Bobbin Winder Frame Hinge Pin
225455	10884	" " " Spring
225456	10884	" " " " Plunger
225458	10884	" " Stop Latch Thumb Lever,for 225382
225459	10884	Bobbin Winder Stop Latch Thumb Lever Hinge Stud,for 225382
225459	10884	Bobbin Winder Stop Latch Thumb Lever Joint Stud,for 225382
225461	10881	Bobbin Winder Tension Bracket with 201499B,for 225462
225462	10881	Bobbin Winder Tension Bracket complete, Nos.201572B,202407,225461 and two 2102 ,for 225382
*225482	-----	Bobbin Case Screw Driver Blade,for 225497
*225483	-----	Bobbin Case Screw Driver Handle,for 225497
*225484	-----	Screw Driver Blade,for 225498
*225485	-----	" " Handle,for 225498
225497	10776	Bobbin Case Screw Driver complete,Nos. 225482 and 225483
225498	10776	Screw Driver complete (7-1/4 in. long), Nos.225484 and 225485
225554	10776	Wrench (steel)
225648	12868	Binder Tape Tension Pin,for 230125
225903	12858	Needle Bar Frame Pitman Connection Slide Stop Screw Washer
226074	12857	Binder Swing Bracket Base,for 230262
226247	12867	Throat Plate,50 needle hole,for needle sizes 14 and 15,for binding,for 207620 and 226978,for Machine No.17w1
226248	12867	Throat Plate,50 needle hole,for needle sizes 14 and 15,for binding,for 226250 and 226979,for Machine No.17w2
226250	12861	Feed Dog,for 226248 and 226251
226251	-----	Binder complete,Nos.207105,226250 and 226979,for Machine No.17w2
226252	-----	Binder complete,Nos.207105,207620 and 226978,for Machine No.17w1
226978	-----	Throat Plate 226247 with 200155F and 259119,for 226252
226979	-----	Throat Plate,226248 with 200154F and 230577,for 226251

No.	Plate	Name
227308	12856	Knee Lifter Connection Lever Lifting Rod with 202302,for 208506
227728	15911	Knee Lifter Rock Lever Rod with 227729, for 228298
*227729	-----	Knee Lifter Rock Lever Rod Cap,for 227728
228026	10884	Bobbin Winder Tension Bracket Screw Washer,for 225382
228026	10884	Needle Bar Frame Pitman Connection Slide Washer,for 204944 and 204945
228218	-----	Drip Pan with four 1 in. wire nails
228284	15911	Knee Lifter Rock Lever Knee Plate with 356C,for 228298
228294	15911	Knee Lifter Rock Lever with two 356C,for 228299
228295	15911	Knee Lifter Rock Lever Bracket with 356C and four wood screws 7/8 in., No.12 for 228299
228296	15911	Knee Lifter Rock Lever Extension with 200529C,for 228298
228297	15911	Knee Lifter Rock Lever Hinge Pin,for 228299
228298	15911	Knee Lifter complete,Nos.202455,227728, 228284,228296 and 228299
228299	-----	Knee Lifter Rock Lever Bracket 228295 with 228294 and 228297,for 228298
230124	12868	Binder Head,for tapes of various widths, for 230262
230125	12857	Binder Swing Bracket with seven 225648, for 230262
230262	-----	Binder complete,Nos.200922B,201527H, 226074,230124,230125 and two 200463D
230577	12868	Binder Head,for tapes or folded strips of different widths as follows: 7/16, 1/2,9/16,5/8 and 3/4 in.,for 226979
230590	12863	Presser Foot,for Machine No.17w1
230604	12832	Throat Plate,50 needle hole,for needle sizes 14 and 15,for 230605,for Ma- chine No.17w1
230605	12861	Feed Dog,for 230604
231337	12859	Cloth Guide
237837	12854	Knee Lifter Connection Lever,for 208506
244048	10675	Tension Disc,for 206639
259119	12868	Binder Head,for tapes from 1/4 to 1 in., in steps of 1/32 in.,for 226978

PLATE 10438 - FULL SIZE

ILLUSTRATIONS OF PARTS

FOR

MACHINES

Nos. 17w1 and 17w2

200031



200068



200271



200098



200291



202036



204209



204210



204212



204194



202622



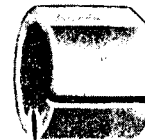
200206



200078



204213



204211

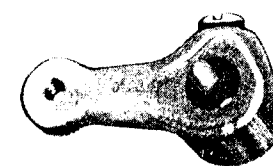
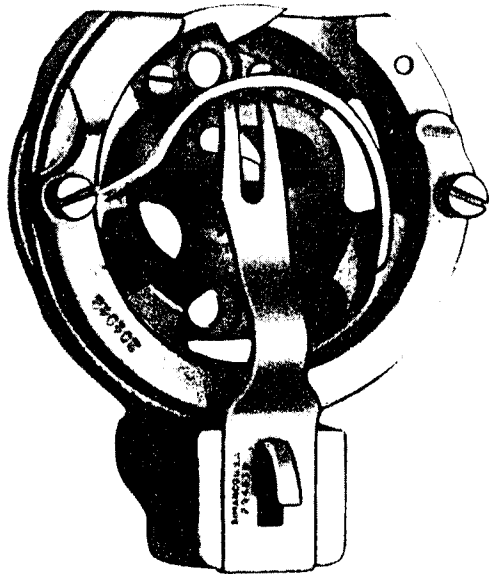


PLATE 10457 - FULL SIZE

204939



204324

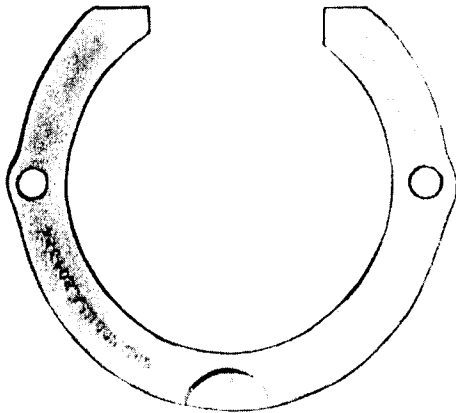
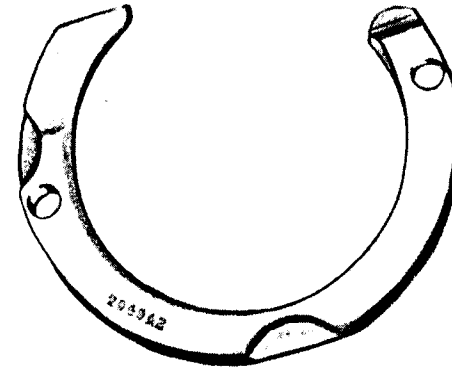


PLATE 10458 - FULL SIZE

204942



204539



204936

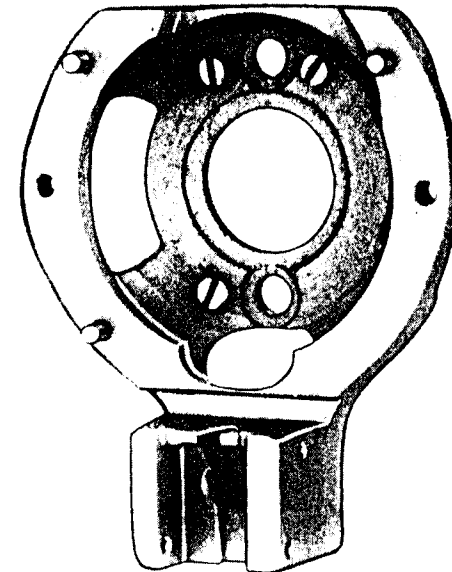
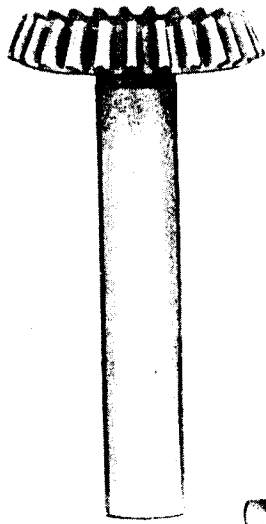
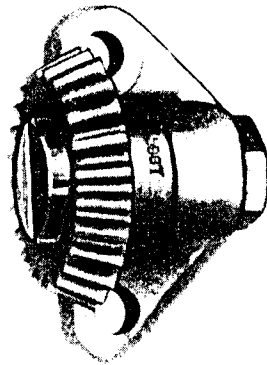


PLATE 10514 - FULL SIZE

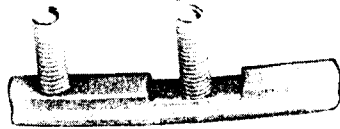
204886



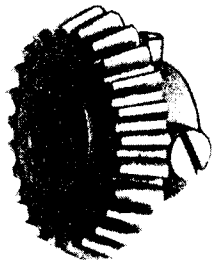
206078



204943



204885



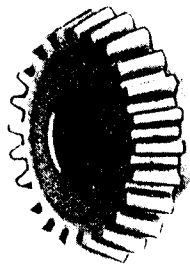
200772



200041



204887



200348



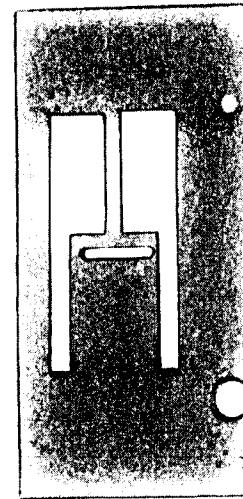
200330

201517

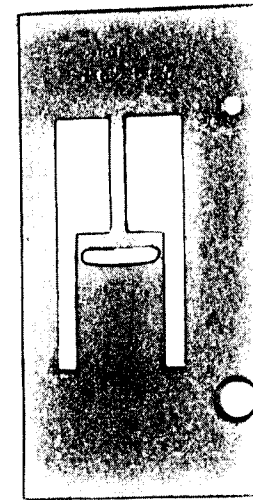


PLATE 10632 - FULL SIZE

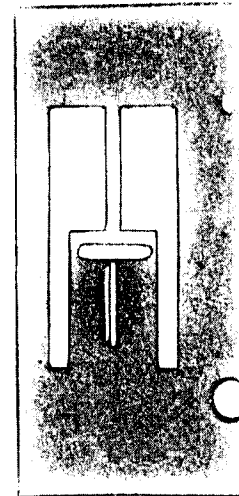
207396



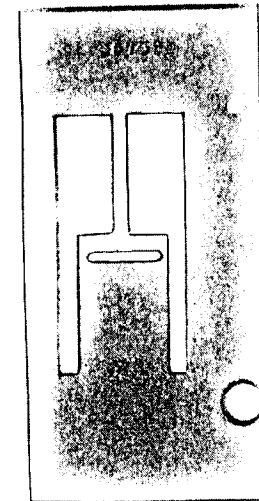
207397



207398



207399



207649

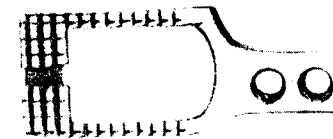


PLATE 10645 - FULL SIZE

200482



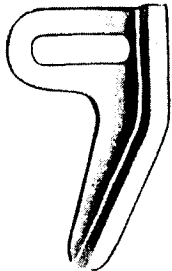
207121



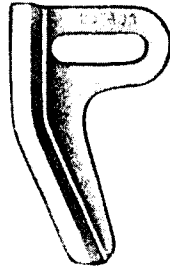
207404



207402



207403



207405

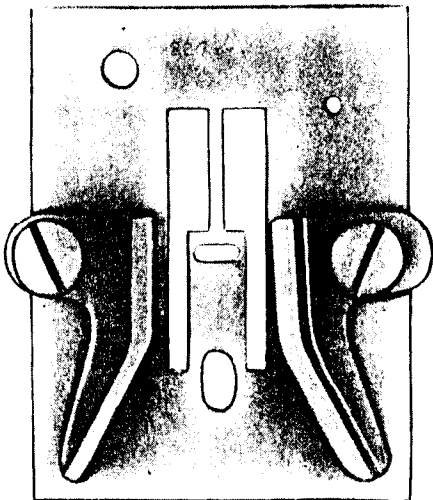
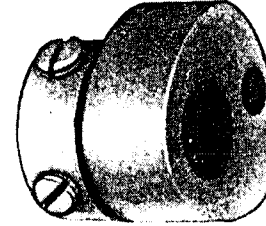


PLATE 10662 - FULL SIZE

204968



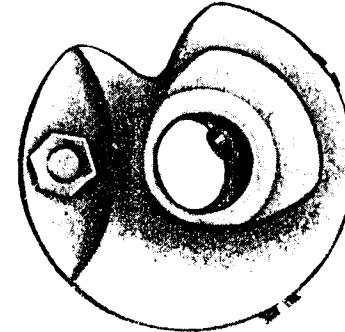
204191



204241



204201



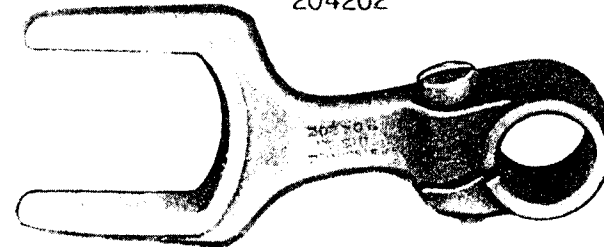
202305



204293



204202



204197



200113



202574



200431



204246



PLATE 10675 - FULL SIZE

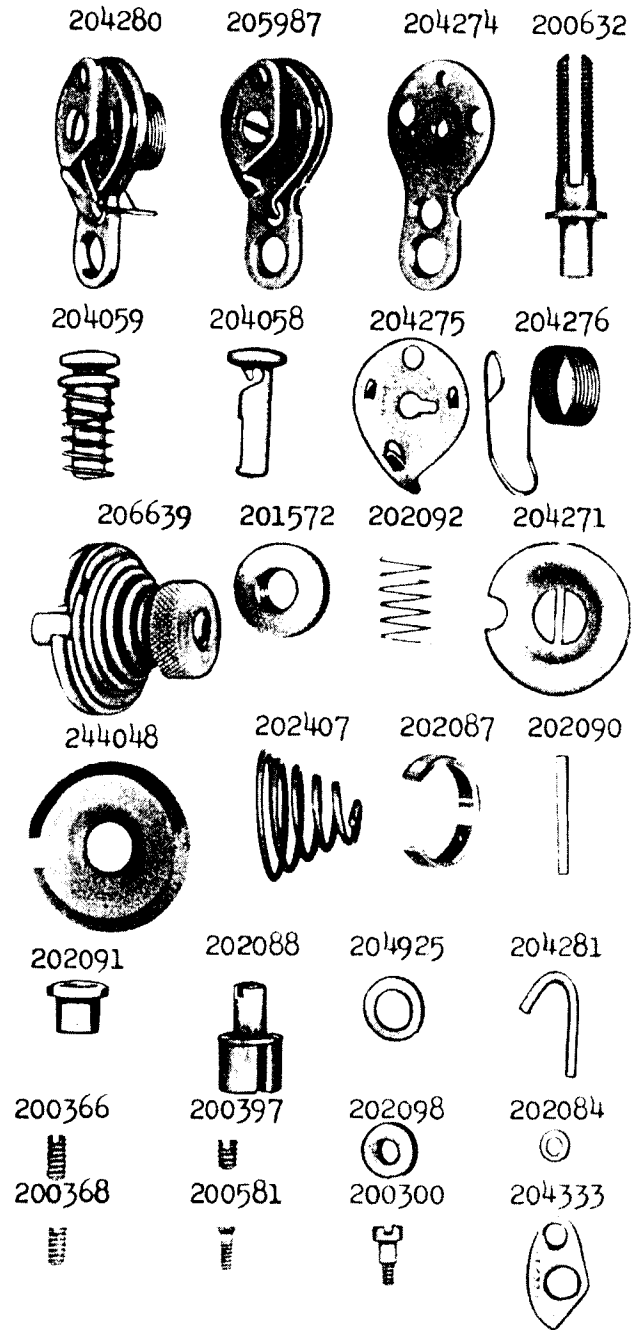


PLATE 10776 - ONE-HALF SIZE

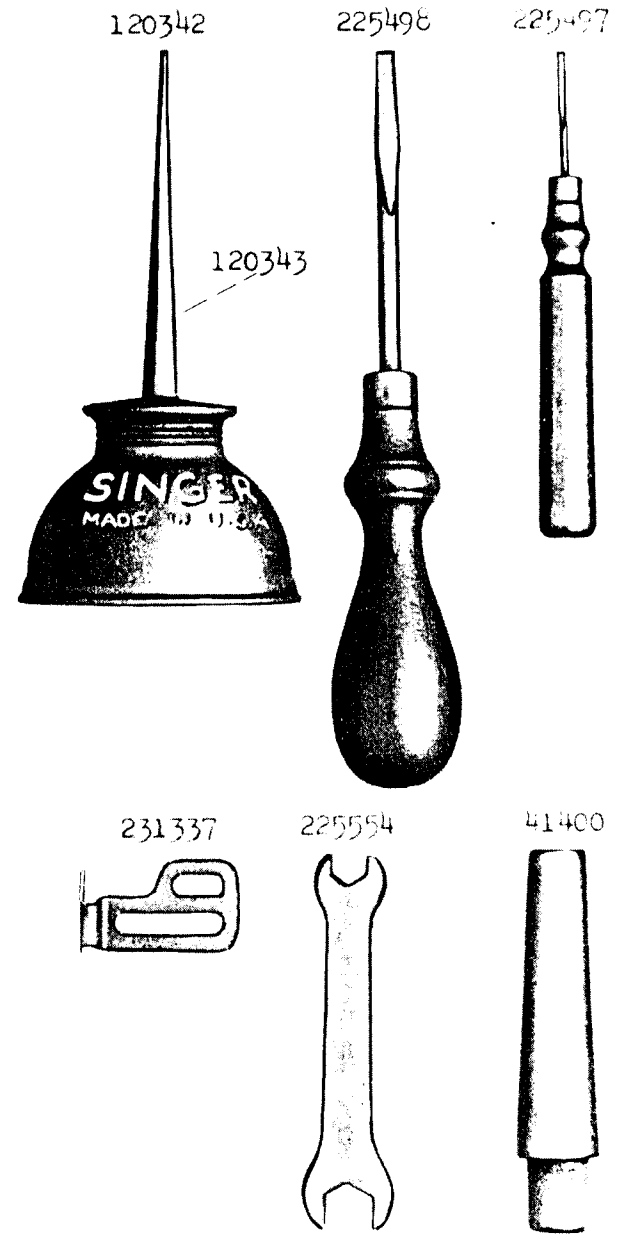
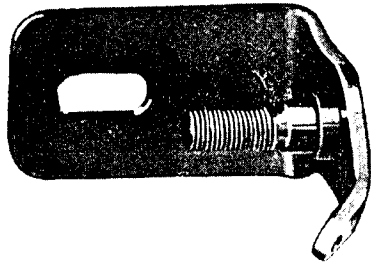


PLATE 10881—FULL SIZE

225461



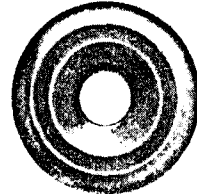
200082



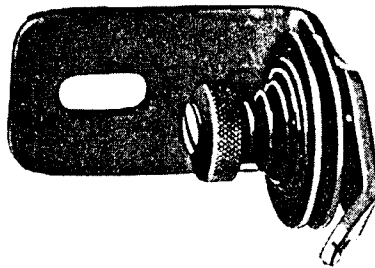
202104



2102



225462



202407



201499

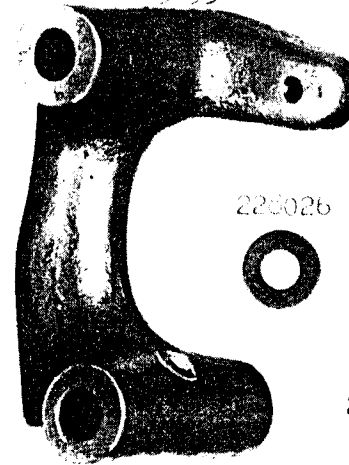


201572



PLATE 10884 - FULL SIZE

225455



225444



202478



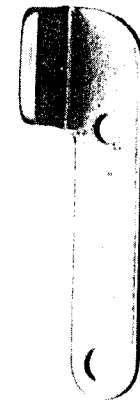
226026



225494



225458



225438



225455



225477



225456



200299



200380



200056



225381



PLATE 10885 -- ONE-FOURTH SIZE

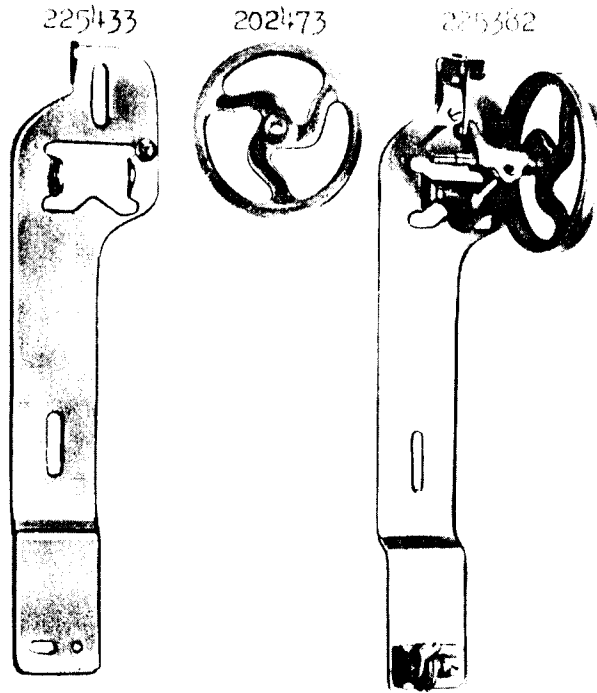


PLATE 12311 -- FULL SIZE

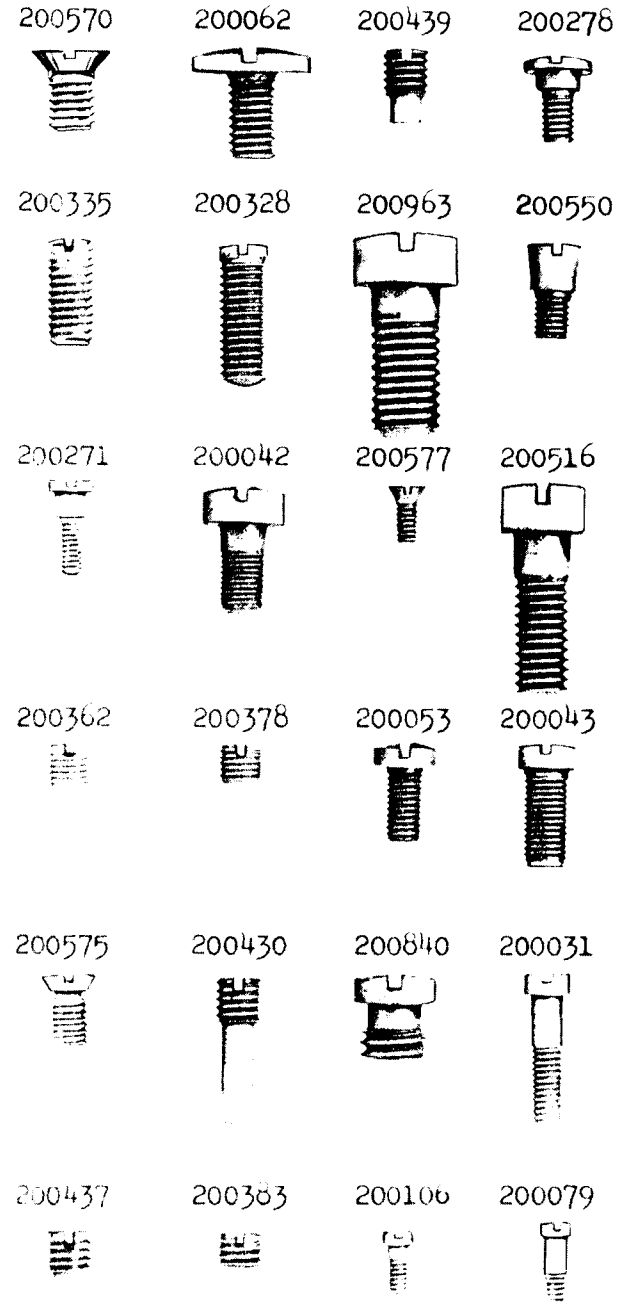
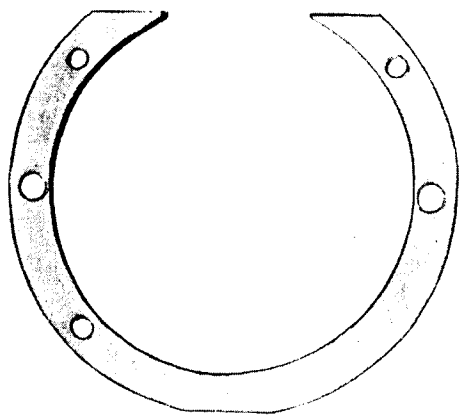
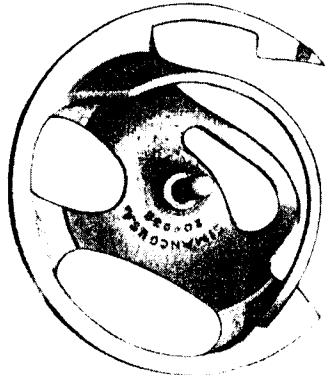


PLATE 12822 - FULL SIZE

204226



204935

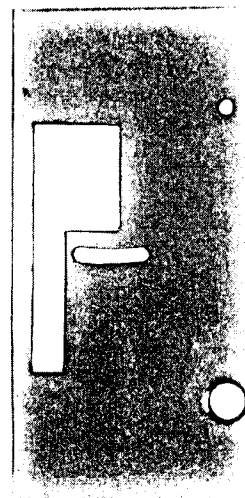


204535

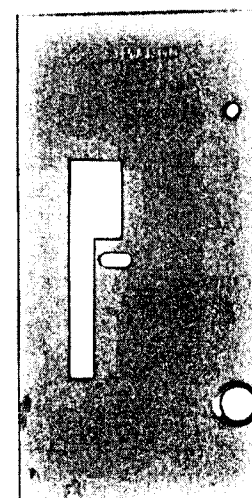


PLATE 12831 - FULL SIZE

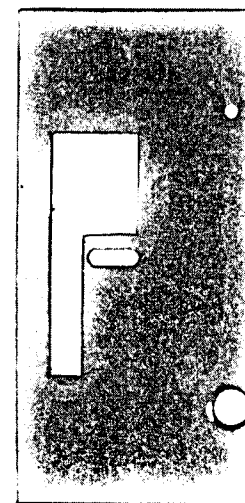
207456



207388



207371



207491

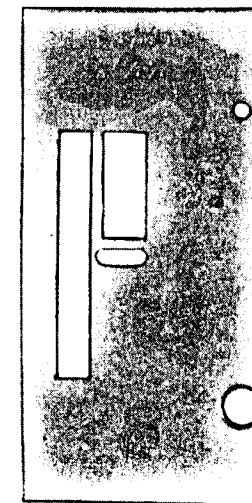
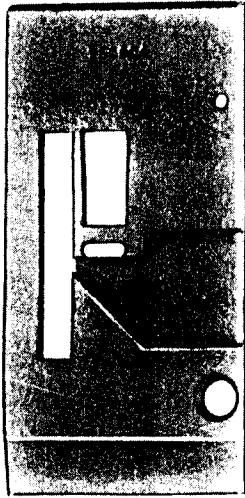
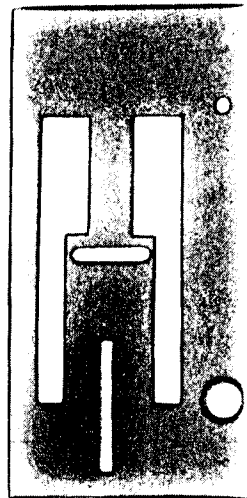


PLATE 12832 - FULL SIZE

230604



206094



207501

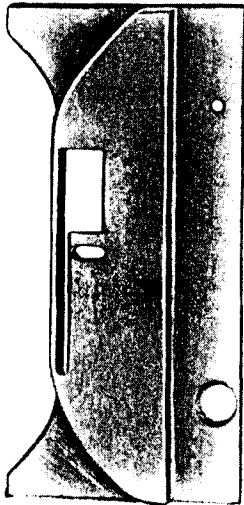
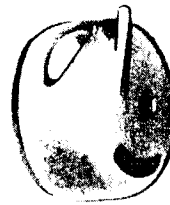
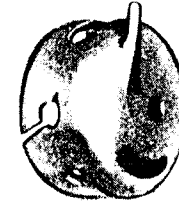


PLATE 12851 - FULL SIZE

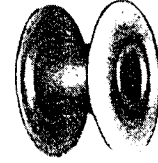
208382



208384



204178



204182



204531



204235



200459



202248



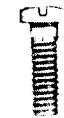
202005



204189



200054



200214



204185



204188



200002



201525



204181



200027



200598



200592



201522



201524



PLATE 12852 - ONE-HALF SIZE

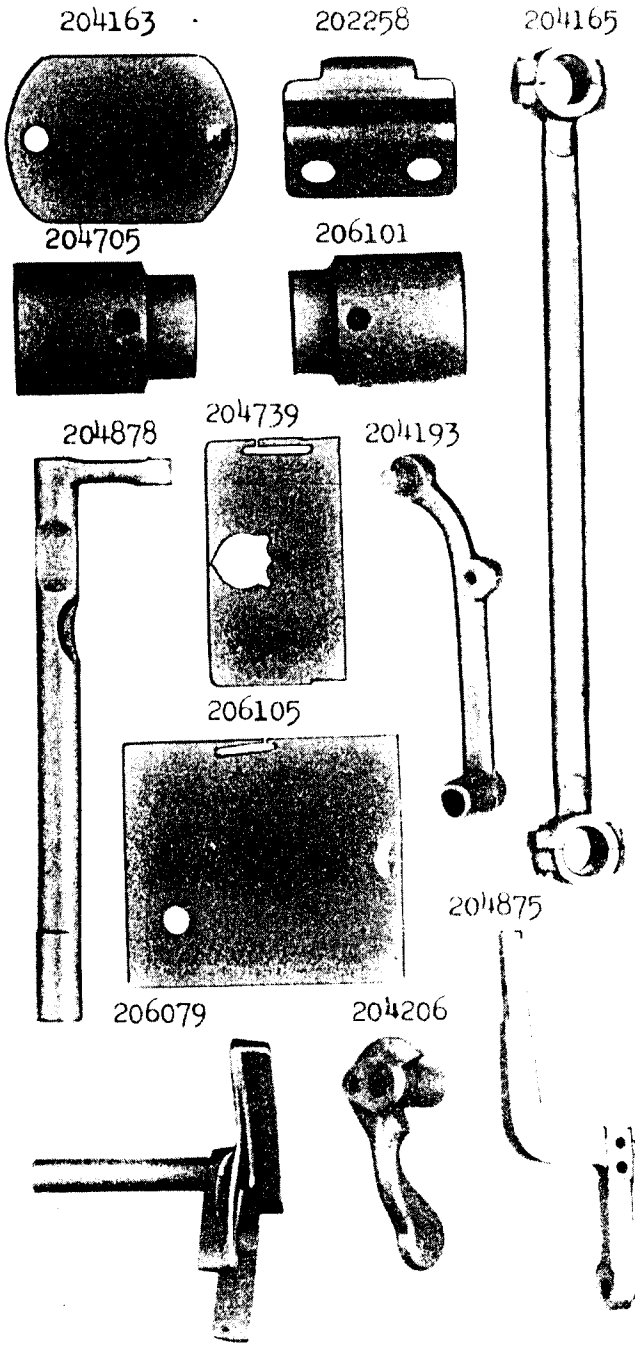


PLATE 12853 - FULL SIZE

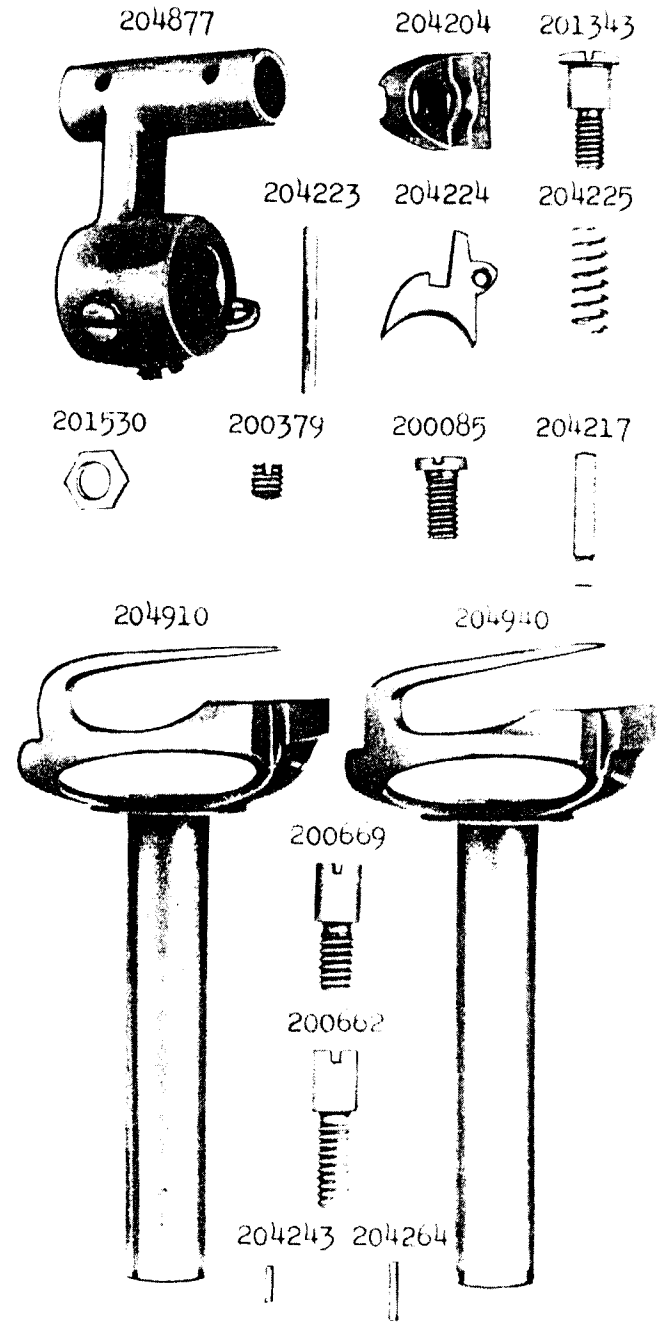


PLATE 12854 - ONE-FOURTH SIZE

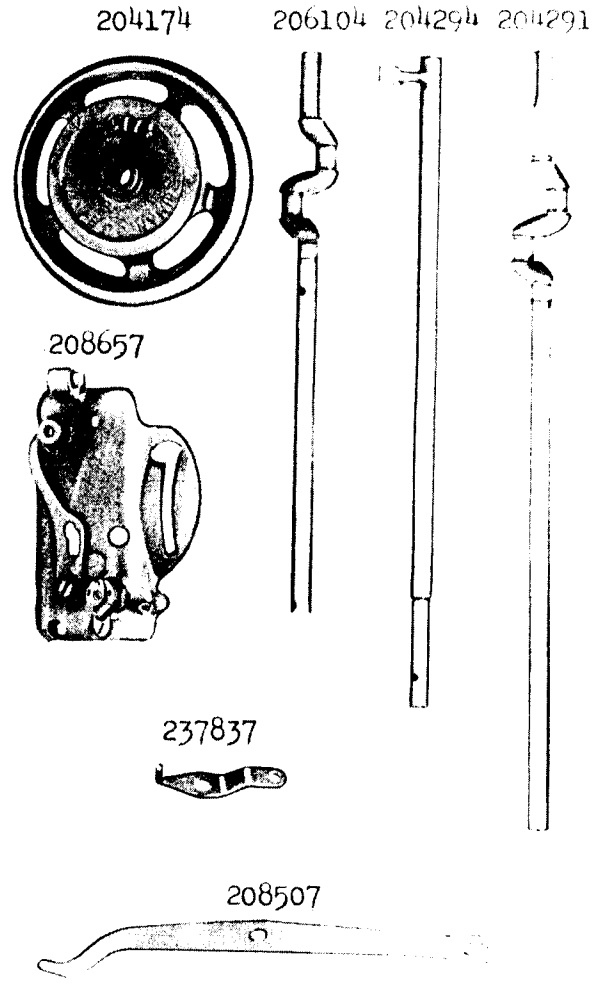


PLATE 12855 - FULL SIZE

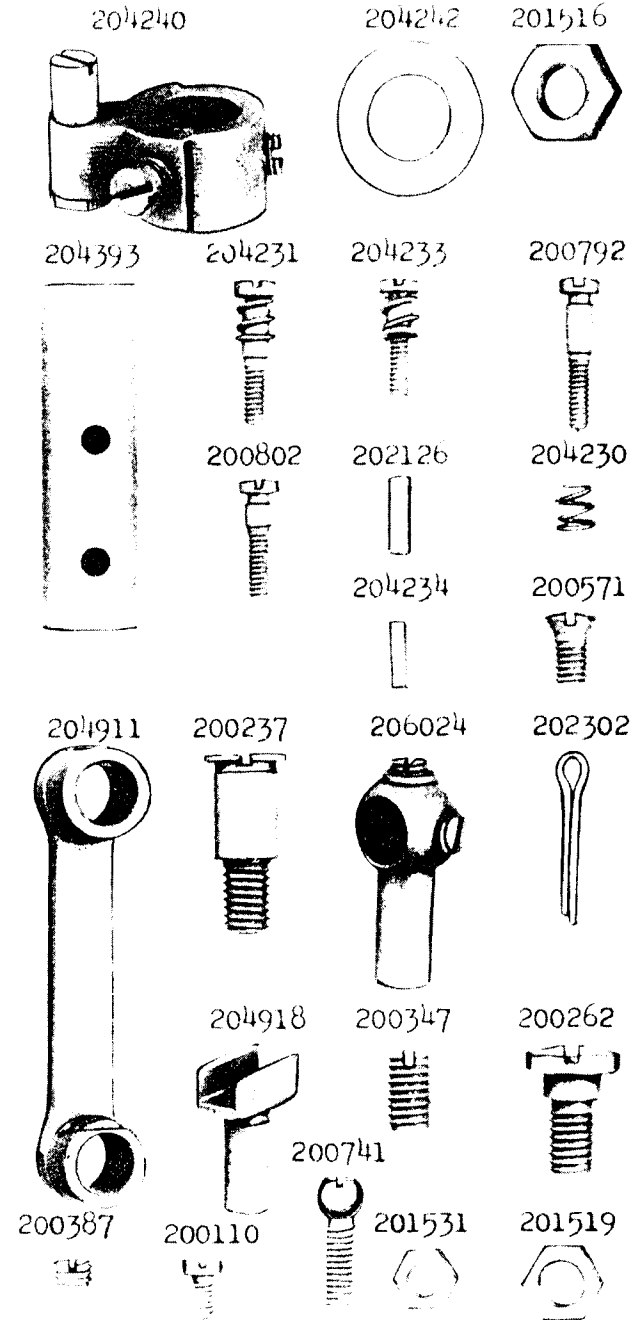


PLATE 12856 - ONE-HALF SIZE

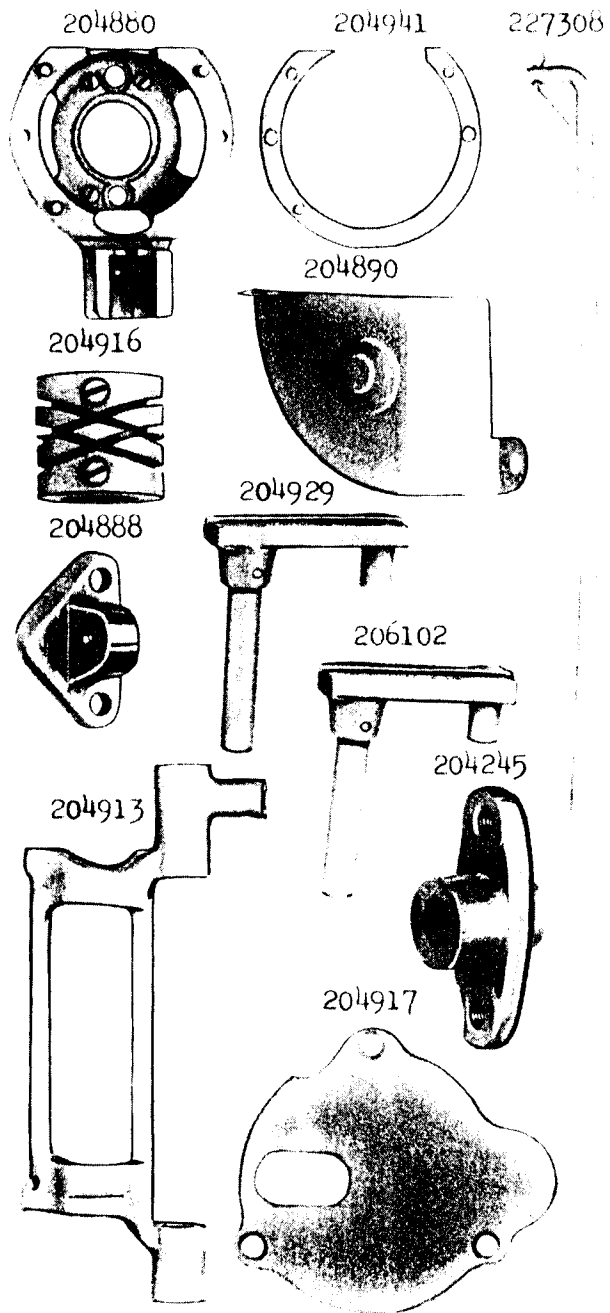


PLATE 12857 - ONE-HALF SIZE

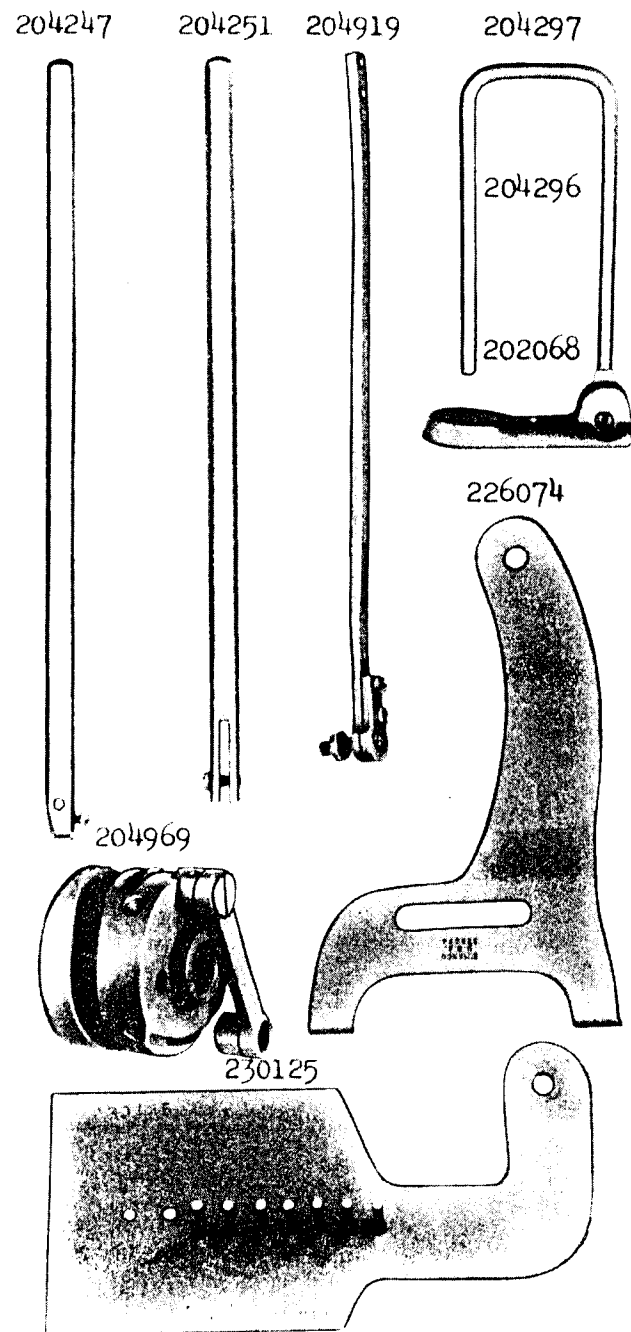


PLATE 12858 - FULL SIZE

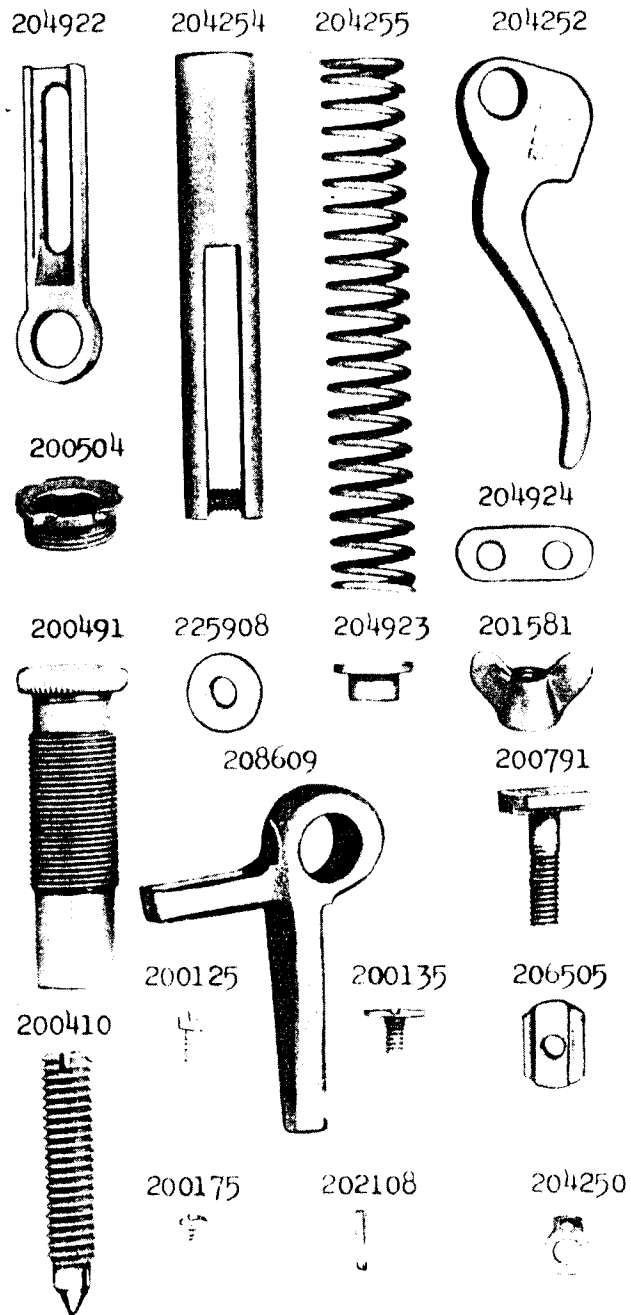


PLATE 12859 - FULL SIZE

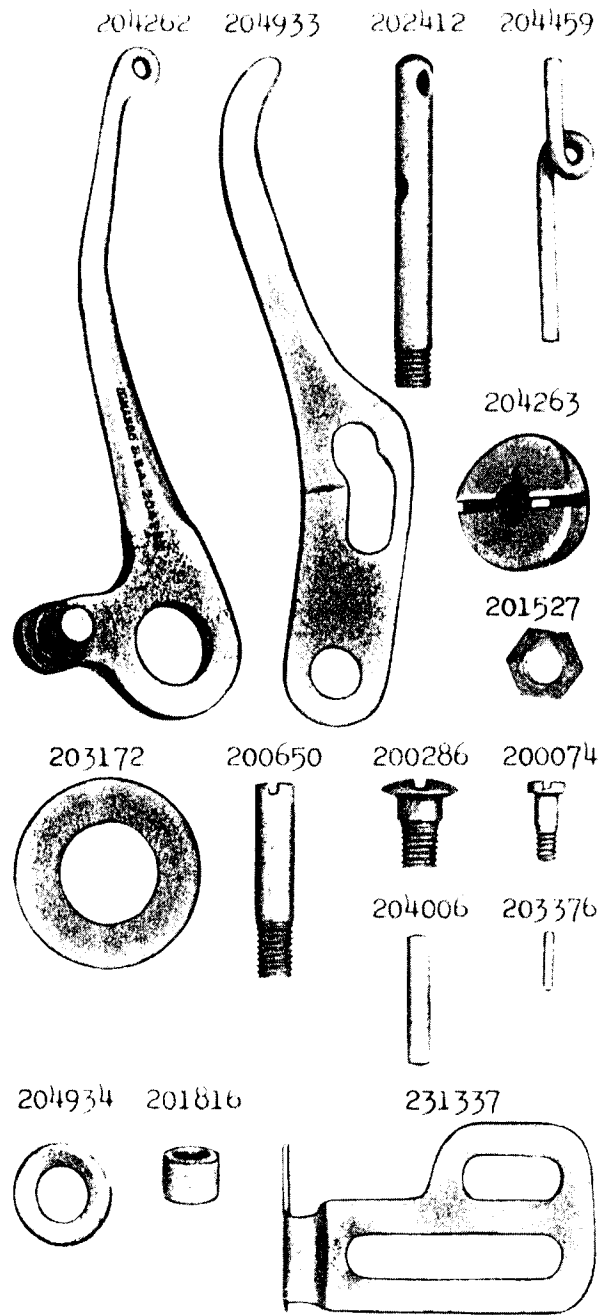


PLATE 12860 - FULL SIZE

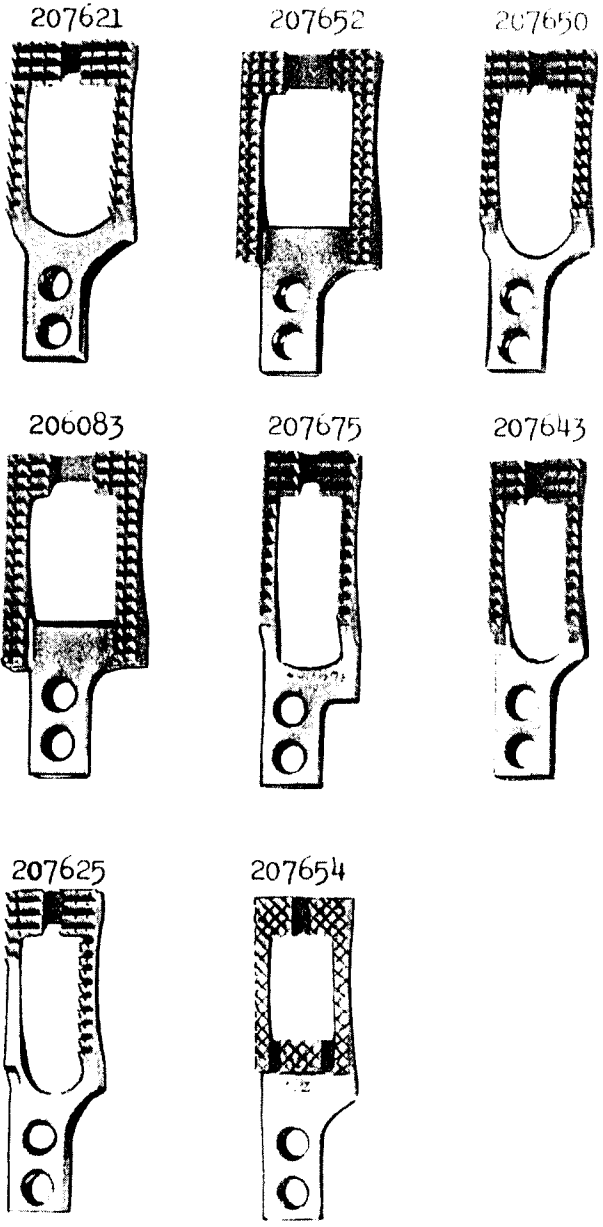


PLATE 12861 - FULL SIZE

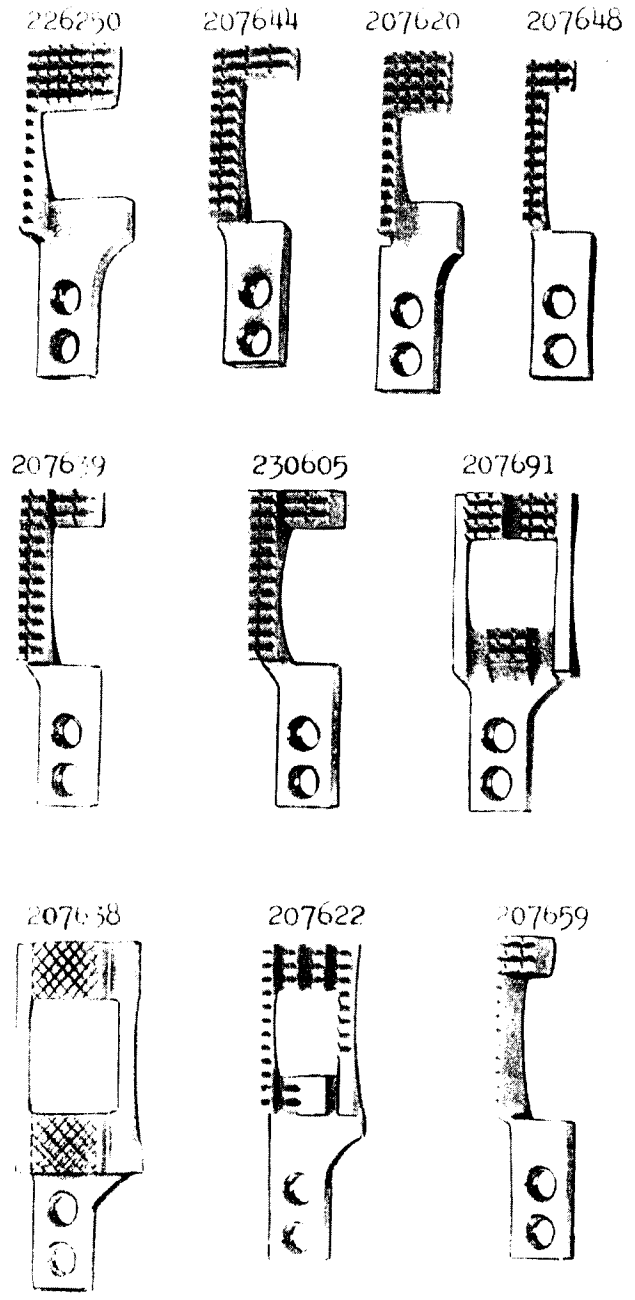
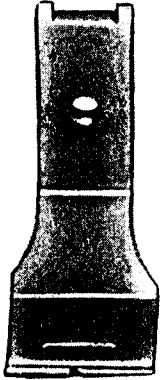


PLATE 12862 - FULL SIZE

207187



206099



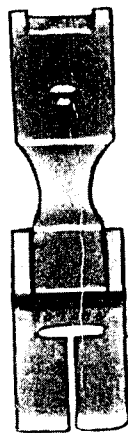
207133



207181



207160



207105



PLATE 12863 - FULL SIZE

207132



207184



207118



230590



207120



207131



207164



207142

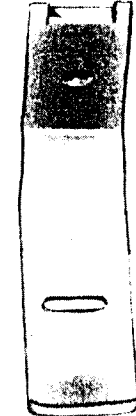
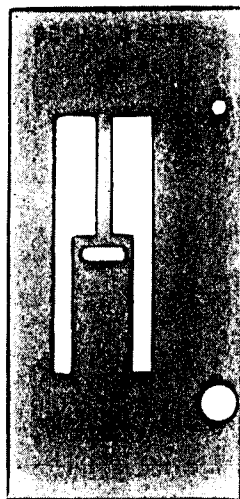


PLATE 12864 - FULL SIZE

207393



207415

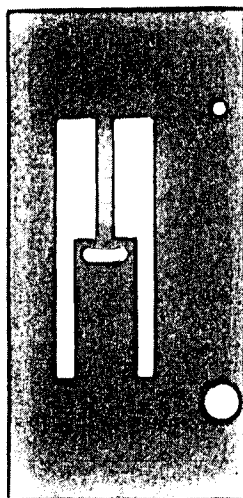
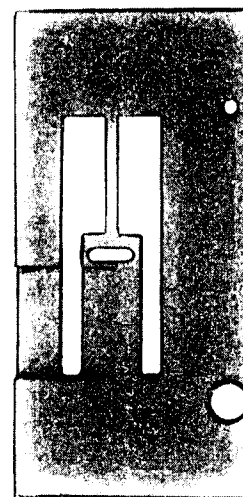
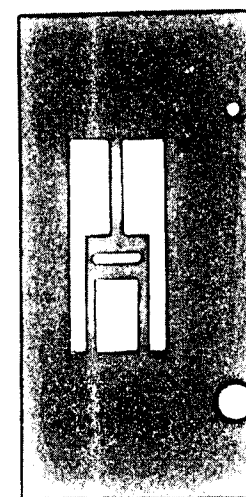


PLATE 12865 - FULL SIZE

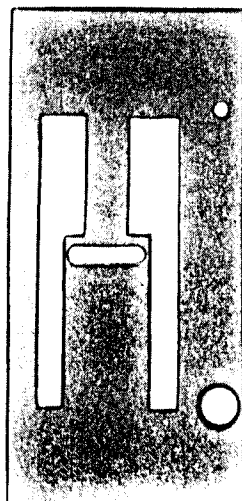
207494



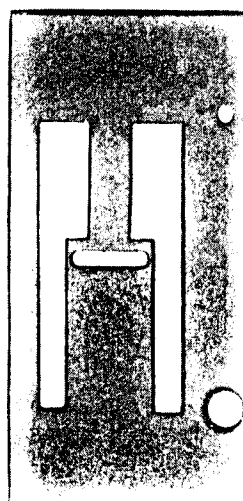
207493



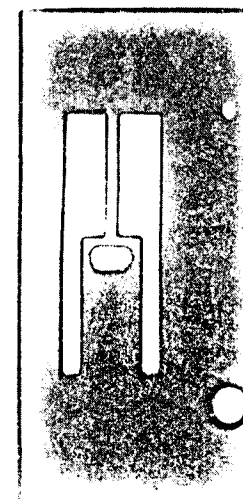
206089



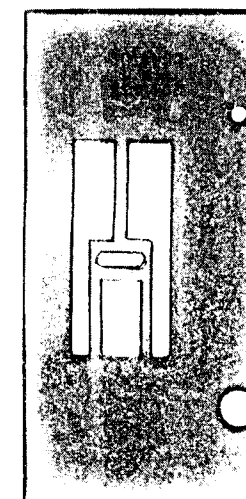
206088



207492



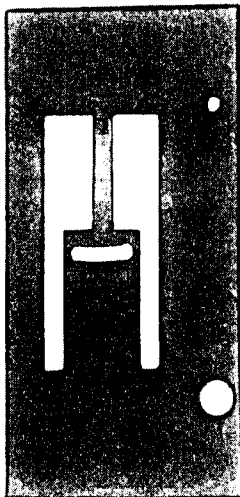
207409



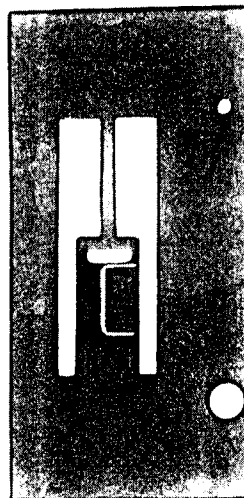
12

PLATE 12866 - FULL SIZE

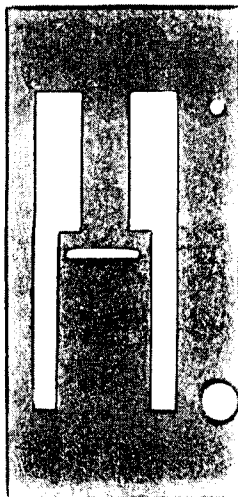
207394



207395



207406



207500

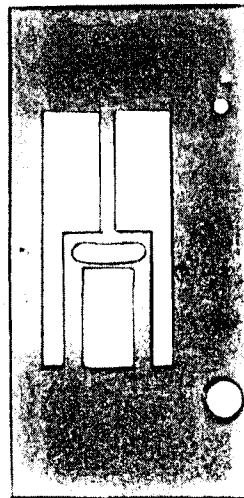
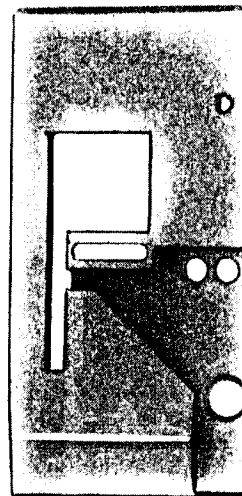
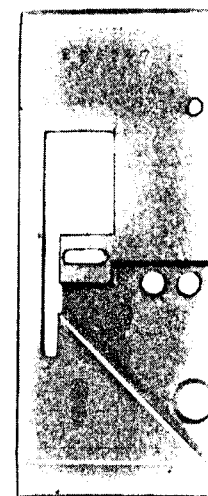


PLATE 12867 - FULL SIZE

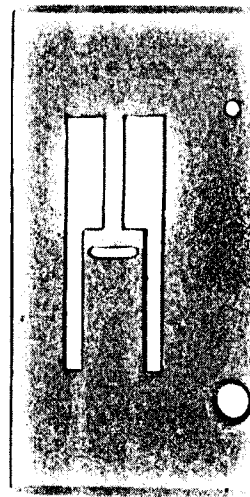
226248



226247



207447



207495

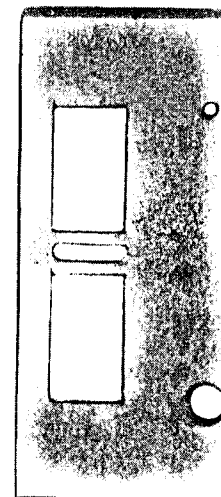


PLATE 12868 - FULL SIZE

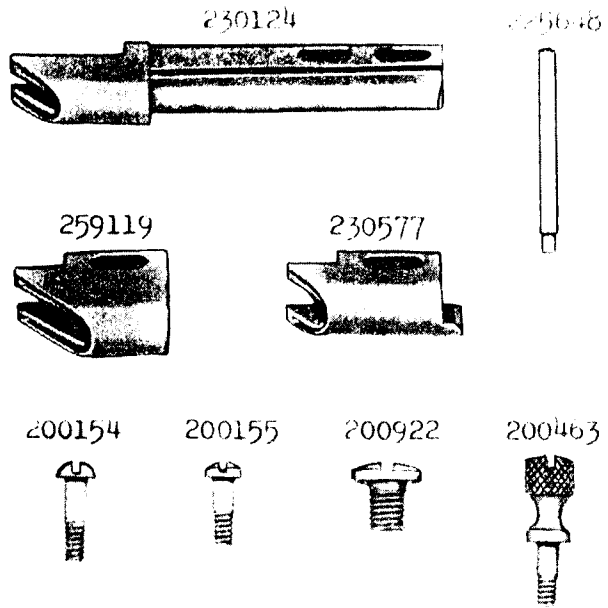


PLATE 1583 - ONE-FOURTH SIZE

