

SINGER
22W1,W110

LIST OF PARTS



MACHINES Nos. 22w1 and 22w110

INDEX

	PAGE
ACCESSORIES	18
BOBBIN WINDER	18
FEED DOGS	22
KNEE LIFTER	19, 20
LAP SEAM FELLER	44
MACHINE No. 22w1	7
" " 22w100	17
NEEDLE HOLDERS	24
NUMERICAL LIST OF PARTS	49
OBSOLETE PARTS	45
PRESSER FEET	25
THREAD UNWINDER	20
THROAT PLATES	35

Instructions for Ordering

In ordering from this list, use **ONLY** the **PART** number in the **FIRST** column.

The number stamped on a Sewing Machine Part is the number of the Single Part only, except when the part includes Set Screws, Clamping Screws, Studs and Rollers Spun on, Small Wires riveted, or Parts soldered together, etc., which it is necessary to furnish in combination.

Every combination of parts sent out has its specific number which, although not stamped on Parts (except in above cases) must be used when ordering the combination.

Each number always indicates the **SAME PART** in whatever list it appears, or for whatever Machine.

The letters after some of the numbers indicate the style of finish only, as follows:

- A. Hardened, Polished and Plated.
- B. Polished and Plated.
- C. Hardened only.
- D. Polished only.
- E. Soft, not polished.
- F. Hardened and Polished.
- H. Blued.

These letters **MUST BE USED** when they appear in the list and **AFTER** the number, as in the list.

In this series

- 200001 to 201500 are Screw Numbers.
- 201501 to 201800 are Nut Numbers.
- 201801 to 202000 are Roller Numbers.
- 202001 and upward are numbers of Machine Parts.

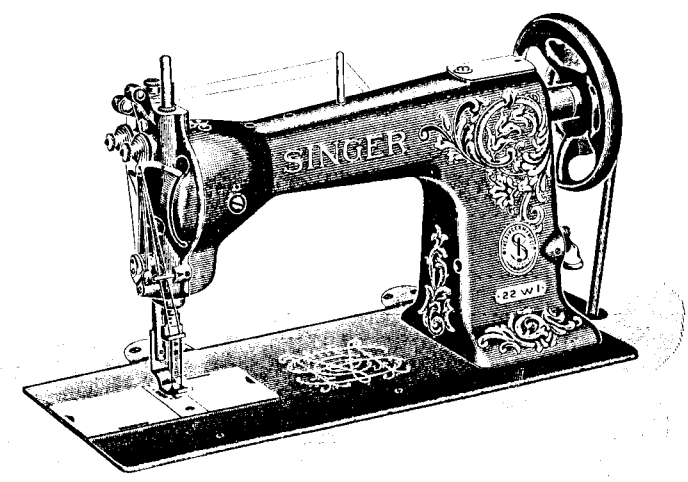
The figures in the second column refer only to the plate in which the illustration of the part is shown and are **NOT TO BE USED** in ordering.

Two or more numbers over a cut indicate that the difference between such parts is not visible in an illustration.

Parts marked with an asterisk (*) are furnished only when repairs are made at the factory.

LIST OF PARTS COMPLETE

FOR



MACHINE No. 22w1

DROP FEED

For Shirts, Underwear, Shirt Waists, Wrappers,
Corsets, etc.

In gauges from $\frac{1}{16}$ to $\frac{3}{4}$ inch.

No.	Plate	Name
*204161	- -	Arm with 200439c, 202036 and 204705
204163	12305	Arm Cap
200278H	12311	" " Screw
202248	12307	" " " Washer
200963E	12311	" Screw (3)
202005	12308	" " Washer (3)
203202	12333	" Shaft
204705	12334	" " Bushing (front)
200439c	12311	" " " Position Screw
204440	12333	" " Connection with four 200054E (2)
200054E	12307	Arm Shaft Connection Screw
202299	-----	" " Oil Packing (wick) (2)

No.	Plate	Name
204805	12333	Balance Wheel, 5½ in. diam. (belt groove 3 in. diam.), with 200328c and 200335c
200062n	12311	Balance Wheel Adjusting Screw ..
200328c	12311	" " Position Screw ...
200335c	12311	" " Set Screw
*203300	---	Bed with 202062, 203248, 203249, two each 200262c, 200516e, 200840e and 202299
202258	12345	Bed Hinge Connection (2)
200570e	12311	" " " " Screw (4) ...
203329	11886	" Slide (back)
203301	12334	" " (front)
203208	12312	Bobbin (2)
203210	12312	" Case Base with 202056, 203211 to 203213 and 203216
203211	12312	Bobbin Case Base Latch
*202056	---	" " " " Pin
203212	12312	" " " " Plunger ..
203213	12312	" " " " Spring ...
203209	12312	" " Cap with 200984c, 203214, 203215 and two 200594c..
203214	12312	Bobbin Case Tension Spring
200984c	12312	" " " " Regulating Screw
200594c	12312	Bobbin Case Tension Spring Screw
203215	12312	" " Thread Guide
200594c	12312	" " " " Screw..
203216	12312	" " Washer (cloth)
203217	12312	Bobbin Case complete, Nos. 203209 and 203210
204533	12333	Face Plate with 200368n, 204730, two each 200368n, 202090, 204281 and three 200397n
200053c	12311	Face Plate Screw
204730	12331	" " Thread Guide
200397n	12309	" " " " Set Screw
204874	12333	Face Plate complete, Nos. 200135c, 200319c, 200577n, 204277 to 204280, 204533, 204555, two each 200309e, 204059 and 204272
203303	12334	Feed Bar with 204189
203309	---	" " 203303 with 200214e, 201525e and 204200
200214e	12331	Feed Bar Hinge Screw
201525e	12331	" " " " Nut
214424	12331	" " Spring
204189	12306	" " Hook
236401	12085	" Dog, for 211878
211298	11887	" " " 211879

No.	Plate	Name
212571	11813	Feed Dog, for 216114
236411	11813	" " " 211053
211055	11813	" " " 211057
236423	11814	" " " 211060
212474	11814	" " " 211063
212169	11814	" " " 211066
211674	12092	" " " 211671
211679	12093	" " " 211676
211685	12093	" " " 211681
200106e	12311	" " Screw (2)
200075e	11890	" " Support Screw
201535e	11890	" " " " Nut
203233	12305	" Driving Cam with 200382c and 200437c
204192	---	Feed Driving Cam Fork Lever with 204195 and 204293
204193	12334	Feed Driving Cam Fork Lever Connection with 200668c and 201525e
204194	12306	Feed Driving Cam Fork Lever Connection Clamp with 200031e ..
200031e	12311	Feed Driving Cam Fork Lever Connection Clamp Pinch Screw
200668c	12334	Feed Driving Cam Fork Lever Connection Clamp Screw Stud
201525e	12331	Feed Driving Cam Fork Lever Connection Clamp Screw Stud Nut
200002e	12332	Feed Driving Cam Fork Lever Connection Hinge Screw
201522e	12332	Feed Driving Cam Fork Lever Connection Hinge Screw Nut
*204195	---	Feed Driving Cam Fork Lever Shaft
204197	12306	Feed Driving Cam Fork Lever Shaft Collar with 200113f
200113f	12308	Feed Driving Cam Fork Lever Shaft Collar Set Screw
204293	12308	Feed Driving Cam Fork Lever Shaft Position Pin
204196	12307	Feed Driving Cam Fork Lever Shaft Sleeve (split)
200043c	12311	Feed Driving Cam Fork Lever Shaft Sleeve Set Screw
201524e	12332	Feed Driving Cam Fork Lever Shaft Sleeve Set Screw Nut ...
204198	12334	Feed Driving Cam Fork Lever complete, Nos. 204192 and 204194 ..
200437c	12311	Feed Driving Cam Position Screw
200382c	11890	" " " Set Screw
204199	12333	" " Rock Shaft

No.	Plate	Name
206554	—	Feed Driving Rock Shaft 204199 with 200002E, 201522E and 204193
202305	12307	Feed Driving Rock Shaft Center (2)
200043c	12311	Feed Driving Rock Shaft Center Set Screw (2)
204200	12305	Feed Driving Rock Shaft Crank with 204189 (on left side) and two 200383c
200383c	12311	Feed Driving Rock Shaft Crank Set Screw
203235	12308	Feed Lifting Cam with 202126 ...
204202	12308	" " " Fork with 200027E
200027E	12332	Feed Lifting Cam Fork Pinch Screw
202126	12308	Feed Lifting Cam Position Pin ...
200045E	12332	" " " Screw
203305	12334	" " Rock Shaft
203315	12334	" " " " 203305 with 203238
202305	12307	Feed Lifting Rock Shaft Center (2)
200043c	12311	Feed Lifting Rock Shaft Center Set Screw (2)
202276	12308	Feed Lifting Rock Shaft Slide Block
203238	12308	Feed Lifting Rock Shaft Slide Block 202276 with 200243E and 201531E
200243E	12332	Feed Lifting Rock Shaft Slide Block Hinge Screw
201531E	12308	Feed Lifting Rock Shaft Slide Block Hinge Screw Nut
204206	12306	Feed Regulating Handle
204207	12334	" " " " 204206 with 200098F, 202622, 204208 to 204210, 204213 and 204925
204208	12307	Feed Regulating Handle Adjustable Stop
200098F	12307	Feed Regulating Handle Adjustable Stop Screw
204925	12306	Feed Regulating Handle Adjustable Stop Screw Washer
204209	12307	Feed Regulating Handle Position Pin
204210	12306	Feed Regulating Handle Shaft
204211	12306	" " " " Crank with 200098F

No.	Plate	Name
204212	12307	Feed Regulating Handle Shaft Crank Link
200271E	12311	Feed Regulating Handle Shaft Crank Link Hinge Screw (lower)
200291E	12307	Feed Regulating Handle Shaft Crank Link Hinge Screw (upper)
200038F	12307	Feed Regulating Handle Shaft Crank Set Screw
204213	12307	Feed Regulating Handle Shaft Sleeve (split)
200362c	12311	Feed Regulating Handle Shaft Sleeve Set Screw
202622	12306	Feed Regulating Handle Shaft Sleeve Washer
202036	12332	Feed Regulating Handle Stop Pin
204214	-	Feed Regulating Handle complete, Nos. 200291E, 204207, 204211 and 204212
*203239	-	Hook (sewing)
203240	12312	" 203239 with 201253F, 201376F and 203251
203290	12312	Hook and Bobbin Case complete, Nos. 203217 and 203240
203241	11007	Hook Bevel Gear Socket, 24 teeth
200555H	11007	" " " " Screw ..
203242	11007	" " Pinion, 24 teeth, with two 200383c (2)
200383c	12311	Hook Bevel Pinion Set Screw
203306	12333	" Counter Shaft
203244	11007	" " " Collar with two 200393c
200393c	11007	Hook Counter Shaft Collar Set Screw
203245	11007	Hook Counter Shaft Driving Gear, 44 teeth, with 200362c and 200439c
213154	12305	Hook Counter Shaft Driving Gear 203245 with 200045E and 203235
200439c	12311	Hook Counter Shaft Driving Gear Position Screw
200362c	12311	Hook Counter Shaft Driving Gear Set Screw
203246	11007	Hook Counter Shaft Gear, 22 teeth, with two 200383c
200383c	12311	Hook Counter Shaft Gear Set Screw
202299	—	Hook Counter Shaft Oil Packing (wick)
200840E	12311	Hook Counter Shaft Oil Packing (wick) stop Screw
203247	12333	Hook Driving Shaft

No.	Plate	Name
203248	12334	Hook Driving Shaft Bearing with 202299
202299	-----	Hook Driving Shaft Bearing Oil Packing (wick)
202126	12308	Hook Driving Shaft Bearing Position Pin
200516E	12311	Hook Driving Shaft Bearing Screw
203249	11007	" " " Bushing (eccentric)
202299	-----	Hook Driving Shaft Bushing Oil Packing (wick)
200362c	12311	Hook Driving Shaft Bushing Set Screw
213141	11890	Hook Driving Shaft Collar with two 200393c
200393c	11007	Hook Driving Shaft Collar Set Screw
203251	12312	Hook Gib
201376F	11890	" " Hinge Screw
201253F	12312	" " Screw
203307	12335	" Saddle (left or right) with 202299
202299	-----	Hook Saddle Oil Packing (wick) ..
200006E	11007	" " Screw (4)
225585E	11007	" " " Washer (4)
203254	12312	" Washer
203308	12335	Hook Saddle (left or right) complete, Nos. 200555H, 203241, 203254, 203290 and 203307
203462	-----	Hook Saddle Combination (left and right) complete, Nos. two 203308
202445	11125	Knee Lifter Connection Lever with 202446
227311	-----	Knee Lifter Connection Lever 202445 with 200224H, 200262H, 227302 and 227308
200224H	12306	Knee Lifter Connection Lever Hinge Screw
227308	11125	Knee Lifter Connection Lever Lifting Rod with 202302
202302	12306	Knee Lifter Connection Lever Lifting Rod Cotter Pin
202446	12306	Knee Lifter Connection Lever Pin
227302	11125	" " Lifting Lever
200262H	12306	" " " " Hinge Screw
231390	11886	Needle Bar (hollow)
204248	12307	" " Connecting Link
200658c	12307	" " " " Hinge Screw Stud

No.	Plate	Name
201519c	12307	Needle Bar Connecting Link Hinge Screw Stud Nut
204249	12308	Needle Bar Connecting Stud with 200072c and 202277
202277	-----	Needle Bar Connecting Stud Oil Packing (wick)
200072c	12308	Needle Bar Connecting Stud Pinch Screw
204326	-----	Needle Bar Packing Cord (2)
200504E	12331	" " Screw Bushing (lower)
200503H	12331	" " " " (upper)
231388	11890	" Holder, needles $\frac{3}{16}$ in. apart and must be set diagonally, in gauges $\frac{1}{16}$, $\frac{3}{16}$ and $\frac{1}{4}$ in., with 201030F and two 200141F
231383	11890	Needle Holder, in gauges from $\frac{3}{16}$ to $\frac{1}{2}$ in., in steps of $\frac{1}{16}$ in., with 201030F and two 200141F
231385	11890	Needle Holder, in gauges from $\frac{1}{16}$ to $\frac{3}{4}$ in., in steps of $\frac{1}{16}$ in., with 201030F and two 200141F
201030F	11890	Needle Holder Screw
200141F	12332	" Set Screw
204251	12334	Presser Bar (hollow) with 200074F
204252	12308	" " Lifter
200550c	12311	" " " Hinge Screw ..
204253	12308	" " Lifting Bracket with 200086c
200086c	12308	Presser Bar Lifting Bracket Pinch Screw
204254	12307	Presser Bar Lifting Bracket Position Guide
200362c	12311	Presser Bar Lifting Bracket Position Guide Set Screw
204327	12306	Presser Bar Packing Washer (felt)
200504E	12331	" " Screw Bushing (lower)
204255	12331	" " Spring
200491H	12305	" " Thumb Screw (pressure regulating)
229092	11883	Presser Foot, 50 needle hole, needles $\frac{3}{16}$ in. apart, in gauges $\frac{1}{16}$, $\frac{3}{16}$ and $\frac{1}{8}$ inch
229102	13071	Presser Foot, 46 needle hole, in gauges $\frac{1}{16}$, $\frac{1}{8}$, $\frac{3}{16}$, $\frac{1}{4}$ and $\frac{1}{2}$ inch
229103	13071	Presser Foot, 46 needle hole, in gauges $\frac{1}{8}$, $\frac{3}{16}$ and $\frac{1}{4}$ inch
229104	13071	Presser Foot, 46 needle hole, in gauges from $\frac{1}{16}$ to $\frac{1}{2}$ in., in steps of $\frac{1}{16}$ inch

No.	Plate	Name
229105	13072	Presser Foot, 46 needle hole, in gauges $\frac{13}{32}$ and $\frac{1}{8}$ inch
229106	13072	Presser Foot, 46 needle hole, in gauges $\frac{13}{32}$, $\frac{5}{8}$, $\frac{3}{16}$ and $\frac{1}{8}$ inch
229107	13072	Presser Foot, 46 needle hole, in gauges $\frac{3}{16}$ and $\frac{1}{4}$ inch
200074F	12308	Presser Foot Screw
212920	-----	Take-up Cam with 200335c and 200430c
203268	12334	Take-up Cam 212920 with 200383c, 200658c and 201519c
203172	12307	Take-up Cam Friction Washer ..
200430c	12311	" " Position Screw
200383c	12311	" " " " Check Screw
200335c	12311	Take-up Cam Set Screw
204553	12331	" Lever
206601	---	" " 204553 with 204263 ..
204263	12331	" " Bearing with 204264 ..
204264	12306	" " " Position Pin ..
200042F	12311	" " " Screw
201816	12307	" " Roller
204554	12331	Take-up Lever complete, Nos. 200042F, 201816 and 206601
202402	12309	Tension Disc
202090	12309	" " Position Pin
204555	12332	" Release Lever
200309F	12309	" " " Screw
202075	12309	" " Plunger
215609	---	" " Slide
204268	12331	" " " 215609 with 204269
204269	12308	Tension Release Slide Spring
202407	10881	" Spring
200632B	12309	" Stud
200397H	12309	" " Set Screw
201572B	10881	" Thumb Nut
204271	12309	" Washer
204272	12309	Tension complete, Nos. 200632B, 201572B, 202075, 202407, 204271 and two 202402
204273	12308	Thread Controller Adjusting Collar with 200684H (for Presser Bar)
200684H	12308	Thread Controller Adjusting Collar Screw
204274	12309	Thread Controller Plate

No.	Plate	Name
200577H	12311	Thread Controller Plate Screw ...
202098	12309	" " Roller
204275	12309	" " " Guard
202084	12309	" " " " Washer
200300c	12309	" " " Screw
204276	12309	" " Spring
204333	12309	" " " Guard
200581H	12309	" " " " Screw
204277	12309	" " " Stop
204278	12309	" " " " Driving Gear
200319c	12309	Thread Controller Spring Stop Driving Gear Hinge Screw
200135c	12309	Thread Controller Spring Stop Screw
204279	12309	Thread Controller Spring Stud with 204925
200366H	11890	Thread Controller Spring Stud Set Screw
204925	12306	Thread Controller Spring Stud Washer
205987	12309	Thread Controller complete, Nos. 200300c, 200581H, 202084, 202098, 204274, 204275 and 204333
204280	12309	Thread Controller and Spring complete, Nos. 204276 and 205987
203313	12331	Thread Guide
204556	12331	" " "
204281	12309	" Retainer Guide Wire
202091	12309	" " Sleeve
202092	12309	" " Spring
204058	12309	" " Stud
200368H	12309	" " " Set Screw
204059	12309	Thread Retainer complete, Nos. 202091, 202092 and 204058
211878	12085	Throat Plate, 50 needle hole, needles $\frac{3}{32}$ in. apart, for needle sizes 14 and 15, in gauges $\frac{1}{16}$, $\frac{1}{8}$ and $\frac{1}{16}$ in., for 236401
211879	12086	Throat Plate, 50 needle hole, for needle sizes 14 and 15, in gauges $\frac{3}{32}$, $\frac{1}{4}$ and $\frac{3}{16}$ in., for 211298
211614	12332	Throat Plate, 50 needle hole, for needle sizes 14 and 15, in gauges $\frac{1}{16}$ and $\frac{1}{32}$ in., for 212571
211053	11813	Throat Plate, 50 needle hole, for needle sizes 14 and 15, in gauges $\frac{1}{4}$ and $\frac{3}{16}$ in., for 236411

No.	Plate	Name
211057	11813	Throat Plate, 50 needle hole, for needle sizes 14 and 15, in $\frac{3}{16}$ in. gauge, for 211055
211060	11814	Throat Plate, 50 needle hole, for needle sizes 14 and 15, in gauges $\frac{1}{4}$ and $\frac{5}{16}$ in., for 236423
211063	11814	Throat Plate, 50 needle hole, for needle sizes 14 and 15, in gauges $\frac{1}{4}$ and $\frac{5}{16}$ in., for 212474
211066	11814	Throat Plate, 50 needle hole, for needle sizes 14 and 15, in gauges $\frac{1}{4}$ and $\frac{1}{2}$ in., for 212169
211671	12092	Throat Plate, 50 needle hole, for needle sizes 14 and 15, in gauges $\frac{1}{4}$, $\frac{5}{16}$ and $\frac{3}{8}$ in., for 211674
211676	12093	Throat Plate, 50 needle hole, for needle sizes 14 and 15, in gauges $\frac{5}{16}$, $\frac{3}{8}$ and $\frac{1}{2}$ in., for 211679
211681	12093	Throat Plate, 50 needle hole, for needle sizes 14 and 15, in gauges $\frac{3}{8}$ and $\frac{1}{2}$ in., for 211685
200161D	12319	Throat Plate Clamp Screw
202062	12308	" " Position Pin
200577H	12311	" " Screw

MACHINE No. 22w110

DROP FEED

For Shirts, Underwear, Shirt Waists, Wrappers,
Corsets, etc.

In gauges from $\frac{1}{16}$ to $\frac{3}{8}$ inch.

The same as Machine No. 22w1 with the following exceptions:

No.	Plate	Name
204290	----	Arm with 200439c, 202036 and 204705, in place of 204161
213622	12333	Arm Shaft, in place of 202302
213052	----	Bed with 202062, 203248, 203249, two each 200362c, 200516e, 200840e and 202299, in place of 203300
204294	12333	Feed Driving Rock Shaft, in place of 204199
206555	----	Feed Driving Rock Shaft 204294 with 200002e, 201522e and 204193, in place of 206554
213624	12333	Hook Driving Shaft, in place of 203247
227312	----	Knee Lifter Connection Lever 202445 with 200224n, 200262n, 227303 and 227308, in place of 227311
227303	11125	Knee Lifter Lifting Lever, in place of 227302

ACCESSORIES

No.	Plate	Name
200157R	12332	Attachment Screw
203208	12312	Bobbin (10)
*225482	---	" Case Screw Driver Blade ..
*225483	---	" " " " Handle ..
225497	12345	Bobbin Case Screw Driver complete, Nos. 225482 and 225483 ..
128 x 3	---	Needles, six each, sizes 12 and 14
225191	---	Drip Pan with four wood screws $\frac{1}{2}$ in., No. 5
41400	12345	Machine Rest Pin (wood)
36578	12345	Oiler with 36579
36579	12345	" Spout, $3\frac{1}{2}$ in. long, with 120117
120117	---	" " Washer
*225484	---	Screw Driver Blade
*225485	---	" " Handle
225498	12345	Screw Driver complete ($7\frac{1}{4}$ in. long), Nos. 225484 and 225485 ..
225554	12345	Wrench (steel)

BOBBIN WINDER

Swing Automatic, Right Hand.

*225451	---	Bobbin Holder
225453	10882	Frame with 202277 and 225438 ..
225454	10882	" Hinge Pin
202277	---	" Oil Packing (wick)
225438	10882	" " Well Cap
225455	10882	" Spring
225456	10882	" " Plunger
202473	10883	Pulley with 200380c
200380c	12319	" Set Screw
*225443	---	Spindle
225452	10882	" 225443 with 225451
225444	10882	Stop Latch
200056E	10882	" " Screw
225458	10882	" " Thumb Lever
225459	10882	" " " " Hinge Stud
225460	10882	" " " " Joint Stud
202478	10882	" " Trip Lever
200299H	10882	" " " " Hinge Screw
225461	10881	Tension Bracket with 201499B ...
200082D	10881	" " Screw
202104	10881	" " " Washer

No.	Plate	Name
2102	10881	Tension Disc
202407	10881	" Spring
201499B	10881	" Stud
201572B	10881	" " Thumb Nut
225462	10881	Bobbin Winder Tension Bracket complete, Nos. 201572B, 202407, 225461 and two 2102
225433	10883	Bobbin Winder and Tension Bracket Base
225436	10883	Universal Bobbin Winder complete, Nos. 200056E, 200082D, 200299H, 202104, 202473, 202478, 225433, 225444, 225452 to 225456, 225458 to 225460, 225462 and two wood screws $\frac{3}{4}$ in., No. 13, R.H.B.

KNEE LIFTER

227781	11125	Knee Lifter Rock Lever with 200522c and 200529c
227782	---	Knee Lifter Rock Lever 227781 with two each 202451 and 202452 ...
227783	11125	Knee Lifter Rock Lever 227782 with 202985 and 227784
202453	11125	Knee Lifter Rock Lever Knee Plate with 200526c
202985	---	Knee Lifter Rock Lever Knee Plate 202453 with 202455
202455	11125	Knee Lifter Rock Lever Knee Plate Arm (short)
200522c	12319	Knee Lifter Rock Lever Knee Plate Arm Set Screw
200526c	12319	Knee Lifter Rock Lever Knee Plate Set Screw
202451	11125	Knee Lifter Rock Lever Lug with two wood screws $\frac{3}{4}$ in., No. 13H
202452	12319	Knee Lifter Rock Lever Lug Hinge Pin
227784	11125	Knee Lifter Rock Lever Rod, 3 in. long, with 227785
*227785	---	Knee Lifter Rock Lever Rod Cap or Oil Guard
200529c	12319	Knee Lifter Rock Lever Rod Set Screw

(Other Knee Lifter parts are listed with parts of machine head.)

THREAD UNWINDER

No.	Plate	Name
202486	---	Spool Pin
202487	---	" Rest
227498	---	" "
202488	10838	" " 202487 with 200363c, 200383c and two 202486
227499	10838	Spool Rest 227498 with 200363c and 202486
202489	10838	Spool Rest Rod
200383c	12311	" " " Set Screw
200383c	12311	" " " Set Screw
202490	10838	" Stand with 200383c
202491	---	" Washer (steel)
202492	---	" Weight with 202493
202493	---	" " Center with 202793 and 203163
203163	---	Spool Weight Center Bushing
202793	---	" " Thread Guide
202794	10838	Thread Eyelet Rod
227605	10838	" " "
227606	10838	" " " Clamp with two 200396c
200396c	11890	Thread Eyelet Rod Clamp Set Screw
200363c	12332	Thread Eyelet Rod Set Screw ...
227500	10838	Thread Unwinder complete. Nos. 202488 to 202490, 202794, 227499, 227605, 227606, three each 202491, 202492 and wood screws $\frac{3}{4}$ in., No. 13

FOR MACHINE NO. 22W110

Same as for No. 22w1 with the following exceptions:

225181	---	Drip Pan with four wood screws $\frac{1}{2}$ in., No. 5, in place of 225191
--------	-----	---

KNEE LIFTER

227781	11125	Knee Lifter Rock Lever with 200522c and 200529c
227782	---	Knee Lifter Rock Lever 227781 with two each 202451 and 202452

No.	Plate	Name
227787	---	Knee Lifter Rock Lever 227782 with 202203 and 227784, in place of 227783
202453	11125	Knee Lifter Rock Lever Knee Plate with 200526c
202203	---	Knee Lifter Rock Lever Knee Plate 202453 with 202454
202454	11125	Knee Lifter Rock Lever Knee Plate Arm (long)
200522c	12319	Knee Lifter Rock Lever Knee Plate Arm Set Screw
200526c	12319	Knee Lifter Rock Lever Knee Plate Set Screw
202451	11125	Knee Lifter Rock Lever Lug with two wood screws $\frac{3}{4}$ in., No. 13
202452	12319	Knee Lifter Rock Lever Lug Hinge Pin
227784	11125	Knee Lifter Rock Lever Rod, 3 in. long, with 227785
*227785	---	Knee Lifter Rock Lever Rod Cap or Oil Guard
200529c	12319	Knee Lifter Rock Lever Rod Set Screw

(Other Knee Lifter parts are listed with
parts of machine head.)

FEED DOGS

No.	Plate	Name
211000	11819	Feed Dog, for 211826 and 211834 ..
211010	11888	" " " 211008, 211748, 211824 and 211825
211014	12114	Feed Dog, for 211831
211043	11816	" " " 211848, 211911 and 211915
236411	11813	Feed Dog, for 211052 to 211054
211055	11813	" " " 211056 to 211058
211246	11887	" " " 211726 and 211727 ..
211298	11887	" " " 211191, 211633 and 211879
211595	11817	Feed Dog, for 211596
236401	12085	" " " 211625 to 211627, 211878 and 212218
211630	12085	Feed Dog, for 211629, 211906 and 212170
211632	12086	Feed Dog, for 211631
211640	11888	" " " 211639
211650	11888	" " " 211649
211652	12090	" " " 211651 and 211859..
211654	12090	" " " 211653
211665	12091	" " " 211663 and 211664..
211669	12092	" " " 211666 and 211667..
211670	12092	" " " 211666 and 211667..
211674	12092	" " " 211671 and 211672..
211675	12092	" " " 211671 and 211672..
211679	12093	" " " 211676 and 211677..
211680	12093	" " " 211676 and 211677..
211684	12093	" " " 211681 and 211682..
211685	12093	" " " 211681 and 211682..
211714	12099	" " " 203769 and 211713..
211717	12099	" " " 211715 and 211716..
211718	12099	" " " 211715 and 211716..
211721	12099	" " " 211719 and 211720..
211722	12099	" " " 211719 and 211720..
211725	12100	" " " 211723 and 211724..
211728	12100	" " " 211726 and 211727..
211729	12100	" " " 211726 and 211727..
211730	11818	" " " 213850
211732	12100	" " " 211018, 211731, 211816 to 211818 and 213850
211733	12100	Feed Dog, for 211018, 211731, 211816 to 211818 and 213850

No.	Plate	Name
211739	11888	Feed Dog, for 211737 and 211870..
211740	11888	" " " 211737 and 211870..
211756	12103	" " " 211755
211758	12103	" " " 211757
211761	12103	" " " 211759, 211760 and 211830
211762	12103	Feed Dog, for 211759, 211760, 211830 and 222217
211765	12104	Feed Dog, for 211749, 211763 and 211764
211766	12104	Feed Dog, for 211749, 211763 and 211764
211769	12104	Feed Dog, for 211767 and 211768..
211770	12104	" " " 211767 and 211768..
211778	12106	" " " 211776 and 211777..
211781	12106	" " " 211779 and 211780..
211786	11887	" " " 211848, 211911 and 211915
211811	12111	Feed Dog, for 211810
211813	12111	" " " 211812
211815	12112	" " " 211814 and 211845..
211820	12112	" " " 211819
211823	12113	" " " 211821
211829	12114	" " " 211828
211836	12115	" " " 211835 and 211849..
211838	12115	" " " 211837
211840	12116	" " " 211839
211844	12116	" " " 211843
211847	12117	" " " 211846
211851	12119	" " " 211850
211853	12119	" " " 211852
211855	12120	" " " 211854
211857	12120	" " " 211856
211883	11816	" " " 211908
211904	12086	" " " 211903 and 212091..
211920	11818	" " " 211918 and 211919..
211921	11819	" " " 211922
211933	11818	" " " 211749, 211763 and 211764
211934	11887	Feed Dog, for 211767 and 211768..
211971	11816	" " " 211972
211995	11887	" " " 211191, 211633 and 211879
212154	11887	Feed Dog, for 211750
212159	11887	" " " 212172
212169	11814	" " " 211065 to 211067....
212175	11887	" " " 203778
212205	11817	" " " 212204
212471	11814	" " " 211062 to 211064....

No.	Plate	Name
212571	11813	Feed Dog, for 211048, 211050 and 211614
212834	11815	Feed Dog, for 211773 and 211774..
212836	11815	" " " 211771
221452	11817	" " " 221451
230602	11819	" " " 230601
236423	11814	" " " 211059 to 211061....

NEEDLE HOLDERS

231383	11890	Needle Holder, in gauges from $\frac{3}{32}$ to $\frac{1}{2}$ in., in steps of $\frac{1}{32}$ in., with 201030F and two 200141F
231385	11890	Needle Holder, in gauges from $\frac{1}{16}$ to $\frac{3}{4}$ in., in steps of $\frac{1}{32}$ in., with 201030F and two 200141F
231388	11890	Needle Holder, needles $\frac{3}{32}$ in. apart and must be set diagonally, in gauges $\frac{3}{32}$, $\frac{7}{32}$ and $\frac{1}{16}$ in., with 201030F and two 200141F
231389	11890	Needle Holder, needles $\frac{1}{4}$ in. apart and must be set diagonally, in gauges $\frac{3}{32}$, $\frac{7}{32}$, $\frac{1}{16}$ and $\frac{3}{32}$ in., with 201030F and two 200141F

PRESSER FEET

No.	Plate	Name
229008	11833	Presser Foot, 50 needle hole, needles $\frac{3}{32}$ in. apart, in gauges $\frac{3}{32}$, $\frac{7}{32}$ and $\frac{1}{16}$ inch
229092	11833	Presser Foot, 50 needle hole, needles $\frac{3}{32}$ in. apart, in gauges $\frac{3}{32}$, $\frac{7}{32}$ and $\frac{1}{16}$ inch
229101	13071	Presser Foot, 50 needle hole, needles $\frac{3}{32}$ in. apart, in gauges $\frac{3}{32}$, $\frac{7}{32}$ and $\frac{1}{16}$ inch
229102	13071	Presser Foot, 46 needle hole, in gauges $\frac{3}{32}$, $\frac{1}{4}$, $\frac{5}{32}$, $\frac{3}{16}$ and $\frac{3}{32}$ inch
229103	13071	Presser Foot, 46 needle hole, in gauges $\frac{1}{4}$, $\frac{5}{32}$ and $\frac{3}{16}$ inch
229104	13071	Presser Foot, 46 needle hole, in gauges from $\frac{1}{16}$ to $\frac{1}{2}$ in., in steps of $\frac{1}{32}$ inch
229105	13072	Presser Foot, 46 needle hole, in gauges $\frac{1}{16}$ and $\frac{3}{16}$ inch
229106	13072	Presser Foot, 46 needle hole, in gauges $\frac{1}{16}$, $\frac{5}{32}$, $\frac{3}{16}$ and $\frac{1}{8}$ inch
229107	13072	Presser Foot, 46 needle hole, in gauges $\frac{3}{32}$ and $\frac{1}{4}$ inch
229125	11890	Presser Foot, 46 needle hole, in gauges $\frac{1}{4}$, $\frac{3}{32}$, $\frac{1}{16}$, $\frac{3}{32}$ and $\frac{1}{4}$ inch
229127	11890	Presser Foot, 46 needle hole, in gauges $\frac{1}{16}$, $\frac{3}{32}$ and $\frac{1}{4}$ inch
222226	11833	Presser Foot, 46 needle hole, in gauges $\frac{1}{16}$, $\frac{3}{32}$ and $\frac{1}{4}$ inch
229296	11834	Presser Foot 46 needle hole, in gauges from $\frac{3}{32}$ to $\frac{1}{2}$ in., in steps of $\frac{1}{32}$ in., for outside staying ..
229308	14022	Presser Foot, 46 needle hole, in gauges from $\frac{1}{16}$ to $\frac{3}{4}$ in., in steps of $\frac{1}{32}$ inch
229493	14009	Presser Foot, 46 needle hole, in gauges $\frac{1}{4}$, $\frac{3}{32}$ and $\frac{1}{16}$ in., for reed and strip lining
229494	14009	Presser Foot, 46 needle hole, in gauges $\frac{1}{16}$, $\frac{3}{32}$ and $\frac{1}{4}$ in., for reed and strip lining
229495	14009	Presser Foot, 46 needle hole, in gauges $\frac{1}{16}$, $\frac{3}{32}$, $\frac{1}{4}$, $\frac{3}{32}$ and $\frac{1}{16}$ in., for reed and strip lining

No.	Plate	Name
229500	14011	Presser Foot, 46 needle hole, in gauges $\frac{1}{16}$, $\frac{1}{8}$, $\frac{1}{4}$, $\frac{3}{8}$ and $\frac{1}{2}$ in., for reed and strip work
229501	14011	Presser Foot, 46 needle hole, in gauges $\frac{1}{8}$, $\frac{1}{4}$ and $\frac{1}{2}$ in., for reed and strip work
229502	14011	Presser Foot, 46 needle hole, in gauges $\frac{1}{16}$, $\frac{1}{8}$, $\frac{1}{4}$, $\frac{3}{8}$ and $\frac{1}{2}$ in., for strip work
229532	11890	Presser Foot, 46 needle hole, in gauges $\frac{1}{8}$, $\frac{1}{4}$, $\frac{3}{8}$, $\frac{1}{2}$ and $\frac{3}{4}$ in., for folding a strip and stitching it over a cord
229533	14021	Presser Foot, 46 needle hole, in gauges from $\frac{1}{16}$ to $\frac{1}{2}$ in., in steps of $\frac{1}{32}$ in., for stitching steels on corsets
229534	14021	Presser Foot, 46 needle hole, in gauges from $\frac{1}{2}$ to $\frac{3}{4}$ in., in steps of $\frac{1}{32}$ in., for stitching steels on corsets
229535	14021	Presser Foot, 46 needle hole, in gauges from $\frac{3}{8}$ to $\frac{3}{4}$ in., in steps of $\frac{1}{32}$ in., for stitching straps on tents, awnings, etc.
229536	14022	Presser Foot, 46 needle hole, in gauges from $\frac{1}{4}$ to $\frac{1}{2}$ in., in steps of $\frac{1}{32}$ in., for strip work
229539	14022	Presser Foot, 46 needle hole, in gauges from $\frac{1}{4}$ to $\frac{3}{4}$ in., in steps of $\frac{1}{32}$ inch
229540	14022	Presser Foot, 53 needle hole, in gauges from $\frac{1}{16}$ to $\frac{1}{4}$ in., in steps of $\frac{1}{32}$ inch
229542	11834	Presser Foot, 46 needle hole, in gauges from $\frac{1}{8}$ to $\frac{1}{2}$ in., in steps of $\frac{1}{32}$ in., with 200172u and 229541
229551	14026	Presser Foot (deep grooved), 46 needle hole, in gauges $\frac{1}{16}$, $\frac{1}{8}$, $\frac{1}{4}$ and $\frac{3}{8}$ in., for top cording
229552	14026	Presser Foot (shallow grooved), 46 needle hole, in gauges $\frac{1}{16}$, $\frac{1}{8}$, $\frac{1}{4}$ and $\frac{3}{8}$ in., for top and bottom cording
229553	14026	Presser Foot (shallow grooved), 46 needle hole, in gauges $\frac{1}{16}$, $\frac{1}{8}$, $\frac{1}{4}$ and $\frac{3}{8}$ in., for top and bottom cording

No.	Plate	Name
229554	14026	Presser Foot (shallow grooved), 50 needle hole, in gauges $\frac{1}{16}$, $\frac{1}{8}$, $\frac{1}{4}$, $\frac{3}{8}$ and $\frac{1}{2}$ in., for top and bottom cording
229555	14026	Presser Foot (deep grooved), 46 needle hole, in gauges $\frac{1}{16}$, $\frac{1}{8}$, $\frac{1}{4}$, $\frac{3}{8}$ and $\frac{1}{2}$ in., for top and bottom cording
229556	14027	Presser Foot (deep grooved), 46 needle hole, in gauges $\frac{1}{16}$, $\frac{1}{8}$, $\frac{1}{4}$ and $\frac{3}{8}$ in., for top and bottom cording
229559	13085	Presser Foot, 50 needle hole, needles $\frac{1}{16}$ in. apart, in gauges $\frac{1}{16}$, $\frac{1}{8}$ and $\frac{1}{4}$ in., for felling
229572	13071	Presser Foot, 50 needle hole, needles $\frac{1}{16}$ in. apart, in gauges $\frac{1}{16}$, $\frac{1}{8}$ and $\frac{1}{4}$ inch
229573	13071	Presser Foot, 46 needle hole, in gauges from $\frac{1}{16}$ to $\frac{1}{4}$ in., in steps of $\frac{1}{32}$ inch
229575	13071	Presser Foot, 46 needle hole, in gauges from $\frac{1}{16}$ to $\frac{1}{4}$ in., in steps of $\frac{1}{32}$ inch
229577	13072	Presser Foot, 46 needle hole, in gauges from $\frac{1}{16}$ to $\frac{3}{8}$ in., in steps of $\frac{1}{32}$ inch
229578	13072	Presser Foot, 46 needle hole, in $\frac{3}{4}$ in. gauge
229584	14021	Presser Foot, 46 needle hole, in gauges from $\frac{1}{16}$ to $\frac{1}{2}$ in., in steps of $\frac{1}{32}$ inch
230795	11890	Presser Foot Hinge Pin
230200	12309	" " " "
221442	---	" " Plate, for 221443
229011	---	" " " " 229010
229013	---	" " " " 229012
229014	---	" " " " 229015
229093	---	" " " " 229094
229095	---	" " " " 229096
229097	---	" " " " 229098
229099	---	" " " " 229100
229128	---	" " " " 229129
229132	---	" " " " 229133
229134	---	" " " " 229135
229138	---	" " " " 229139
229140	---	" " " " 229141
221411	---	" " " " 221410
223900	---	" " " " 223901

No.	Plate	Name
229903	—	Presser Foot Plate, for 229904
229164	—	" " " " 229188
229168	—	" " " " 229169
229191	—	" " " " 229192
229193	—	" " " " 229194
229195	—	" " " " 229167
229197	—	" " " " 229198
229201	—	" " " " 229202
229203	—	" " " " 229204
229215	—	" " " " 229216
229217	—	" " " " 229218
229321	—	" " " " 229322
229368	—	" " " " 229369
229560	—	" " " " 229561
229839	—	" " " " 229840
229964	—	" " " " 229965
229162	—	" " " " 229163
229184	—	" " " " 229935
229241	—	" " " " 229242
229243	—	" " " " 229244
229245	—	" " " " 229246
229247	—	" " " " 229248
229249	—	" " " " 229250
229253	—	" " " " 229254
229261	—	" " " " 229262
229263	—	" " " " 229264
229276	—	" " " " 229278
229279	—	" " " " 229280
229281	—	" " " " 229282
229283	—	" " " " 229284
229285	—	" " " " 229286
229496	—	" " " " 229497
229498	—	" " " " 229499
229504	—	" " " " 229505
229508	—	" " " " 229509
229510	—	" " " " 229511
229512	—	" " " " 229513
229514	—	" " " " 229515
229537	—	" " " " 229538
229557	—	" " " " 229558
229609	—	" " " " 229610
229720	—	" " " " 230697
230830	—	" " " " 230831
222306	—	" " " " 222307
202923	—	" " " Shank
202926	—	" " " "
202930	—	" " " "
202993	—	" " " "
202996	—	" " " "

No.	Plate	Name
229277	—	Presser Foot Shank
202989	11834	" " Spring
229541	11834	" " " Guide, in gauges from $\frac{1}{4}$ to $\frac{1}{2}$ in., in steps of $\frac{1}{32}$ in., for 229542
200172H	11890	Presser Foot Spring Guide Screw
221443	11835	Presser Foot (hinged) complete, 46 needle hole, in gauges from $\frac{1}{4}$ to $\frac{11}{16}$ in., in steps of $\frac{1}{32}$ in., Nos. 202090, 202923 and 221442
229010	11835	Presser Foot (hinged) complete, 46 needle hole, in gauges $\frac{11}{16}$, $\frac{11}{8}$, $\frac{3}{4}$ and $\frac{7}{8}$ in., Nos. 202923, 229011 and 230795
229012	11834	Presser Foot (hinged) complete, 46 needle hole, in gauges from $\frac{11}{16}$ to $\frac{7}{8}$ in., in steps of $\frac{1}{32}$ in., Nos. 202926, 229013 and 230795
229015	11834	Presser Foot (hinged) complete, 46 needle hole, in gauges from $\frac{11}{16}$ to $\frac{7}{8}$ in., in steps of $\frac{1}{32}$ in., Nos. 202923, 229014 and 230795
229094	11833	Presser Foot (hinged) complete, 46 needle hole, in gauges $\frac{1}{4}$, $\frac{3}{8}$ and $\frac{1}{2}$ in., Nos. 202923, 229093 and 230795
229096	11833	Presser Foot (hinged) complete, 46 needle hole, in gauges $\frac{3}{8}$, $\frac{1}{2}$, $\frac{5}{8}$ and $\frac{3}{4}$ in., Nos. 202923, 229095 and 230795
229098	11833	Presser Foot (hinged) complete, 46 needle hole, in gauges $\frac{11}{16}$, $\frac{3}{4}$, $\frac{11}{8}$ and $\frac{7}{8}$ in., Nos. 202923, 229097 and 230795
229100	11833	Presser Foot (hinged) complete, 46 needle hole, in gauges from $\frac{11}{16}$ to $\frac{7}{8}$ in., in steps of $\frac{1}{32}$ in., Nos. 202923, 229099 and 230795
229129	13079	Presser Foot (hinged) complete, 50 needle hole, needles $\frac{3}{16}$ in. apart, in gauges $\frac{1}{2}$, $\frac{5}{8}$ and $\frac{3}{4}$ in., Nos. 202923, 229128 and 230795
229133	13079	Presser Foot (hinged) complete, 46 needle hole, in gauges $\frac{3}{8}$, $\frac{1}{2}$, $\frac{5}{8}$ and $\frac{3}{4}$ in., Nos. 202923, 229132 and 230795
229135	13079	Presser Foot (hinged) complete, 46 needle hole, in gauges $\frac{11}{16}$, $\frac{3}{4}$, $\frac{11}{8}$ and $\frac{7}{8}$ in., Nos. 202923, 229134 and 230795

No.	Plate	Name
229139	11833	Presser Foot (hinged) complete, 46 needle hole, in gauges from $\frac{15}{16}$ to $\frac{5}{8}$ in., in steps of $\frac{1}{16}$ in., Nos. 202923, 229138 and 230795
229141	11833	Presser Foot (hinged) complete, 46 needle hole, in gauges $\frac{31}{32}$, $\frac{11}{16}$, $\frac{23}{32}$ and $\frac{3}{4}$ in., Nos. 202923, 229140 and 230795
229163	13079	Presser Foot (hinged) complete, 50 needle hole, in gauges $\frac{5}{8}$, $\frac{1}{2}$, $\frac{3}{8}$ and $\frac{3}{16}$ in., Nos. 202923, 229162 and 230795
229242	11835	Presser Foot (hinged) complete, 46 needle hole, in gauges $\frac{1}{2}$, $\frac{3}{8}$, $\frac{5}{16}$ and $\frac{11}{16}$ in., Nos. 202090, 202923 and 229241
229244	11835	Presser Foot (hinged) complete, 46 needle hole, in gauges $\frac{3}{8}$, $\frac{11}{16}$ and $\frac{1}{2}$ in., Nos. 202090, 202923 and 229243
229246	11835	Presser Foot (hinged) complete, 46 needle hole, in gauges $\frac{11}{16}$ and $\frac{1}{2}$ in., Nos. 202090, 202923 and 229245
229248	11835	Presser Foot (hinged) complete, 46 needle hole, in gauges $\frac{11}{16}$, $\frac{3}{8}$ and $\frac{11}{16}$ in., Nos. 202090, 202923 and 229247
229250	11835	Presser Foot (hinged) complete, 46 needle hole, in gauges $\frac{5}{8}$, $\frac{31}{32}$ and $\frac{11}{16}$ in., Nos. 202090, 202923 and 229249
229254	11835	Presser Foot (hinged) complete, 46 needle hole, in gauges $\frac{1}{2}$, $\frac{11}{16}$, $\frac{31}{32}$, $\frac{11}{16}$ and $\frac{5}{8}$ in., Nos. 202090, 202923 and 229253
229262	13095	Presser Foot (hinged) complete, 46 needle hole, in gauges from $\frac{1}{8}$ to $\frac{3}{4}$ in., in steps of $\frac{1}{16}$ in., Nos. 202090, 202923 and 229261
229264	13095	Presser Foot (hinged) complete, 46 needle hole, in gauges $\frac{11}{16}$, $\frac{1}{2}$, $\frac{11}{16}$ and $\frac{1}{2}$ in., Nos. 202090, 202923 and 229263
229278	13095	Presser Foot (hinged) complete, 46 needle hole, in gauges $\frac{1}{2}$, $\frac{5}{8}$, $\frac{11}{16}$ and $\frac{3}{4}$ in., Nos. 202090, 229276 and 229277

No.	Plate	Name
229280	13095	Presser Foot (hinged) complete, 46 needle hole, in gauges $\frac{1}{2}$, $\frac{3}{8}$ and $\frac{5}{8}$ in., Nos. 202090, 229277 and 229279
229282	13095	Presser Foot (hinged) complete, 46 needle hole, in gauges $\frac{11}{16}$, $\frac{3}{8}$, $\frac{11}{16}$ and $\frac{1}{2}$ in., Nos. 202090, 229277 and 229281
229284	13095	Presser Foot (hinged) complete, 46 needle hole, in gauges $\frac{1}{2}$, $\frac{11}{16}$ and $\frac{3}{8}$ in., Nos. 202090, 229277 and 229283
229286	11834	Presser Foot (hinged) complete, 46 needle hole, in gauges $\frac{3}{8}$, $\frac{11}{16}$ and $\frac{11}{16}$ in., Nos. 202090, 229277 and 229285
229497	14010	Presser Foot (hinged) complete, 46 needle hole, in gauges $\frac{1}{2}$, $\frac{3}{8}$, $\frac{5}{16}$, $\frac{11}{16}$ and $\frac{3}{4}$ in., Nos. 202090, 202989, 202996 and 229496, for reed and strip lining
229505	14012	Presser Foot (hinged) complete, 46 needle hole, in gauges from $\frac{1}{2}$ to $\frac{3}{16}$ in., in steps of $\frac{1}{16}$ in., Nos. 202090, 202989, 202996 and 229504, for strip work
229509	14012	Presser Foot (hinged) complete, 46 needle hole, in gauges $\frac{1}{2}$, $\frac{3}{8}$, $\frac{5}{16}$, $\frac{11}{16}$ and $\frac{1}{2}$ in., Nos. 202090, 202989, 202996 and 229508, for strip work
229511	14012	Presser Foot (hinged) complete, 46 needle hole, in gauges from $\frac{3}{16}$ to $\frac{1}{8}$ in., in steps of $\frac{1}{16}$ in., Nos. 202090, 202989, 202996 and 229510, for strip work
229513	11834	Presser Foot (hinged) complete, 46 needle hole, in gauges $\frac{11}{16}$, $\frac{1}{2}$, $\frac{11}{16}$ and $\frac{3}{8}$ in., Nos. 202989, 202993, 229512 and 230795
229515	11834	Presser Foot (hinged) complete, 46 needle hole, in gauges $\frac{11}{16}$, $\frac{5}{8}$, $\frac{31}{32}$ and $\frac{11}{16}$ in., Nos. 202989, 202993, 229514 and 230795
229499	14010	Presser Foot (hinged) complete, 46 needle hole, in gauges $\frac{3}{8}$, $\frac{5}{8}$, $\frac{1}{2}$, $\frac{3}{8}$ and $\frac{1}{8}$ in., Nos. 202090, 202989, 202993 and 229498, for reed and strip lining

No.	Plate	Name
229538	14022	Presser Foot (hinged) complete, 46 needle hole, in gauges from $\frac{1}{8}$ to $\frac{1}{2}$ in., in steps of $\frac{1}{16}$ in., Nos. 202090, 202923 and 229537
229558	14027	Presser Foot (hinged) (shallow grooved) complete, 46 needle hole, in gauges $\frac{1}{8}$, $\frac{1}{4}$, $\frac{3}{8}$ and $\frac{1}{2}$ in., Nos. 202090, 202923 and 229557
229610	14022	Presser Foot (hinged) complete, 46 needle hole, in gauges from $\frac{1}{8}$ to $\frac{1}{2}$ in., in steps of $\frac{1}{16}$ in., Nos. 202090, 202923 and 229609
230697	11834	Presser Foot (hinged) complete, 46 needle hole, in gauges from $\frac{1}{8}$ to $\frac{1}{2}$ in., in steps of $\frac{1}{16}$ in., Nos. 202090, 202923 and 229720, for strip work
230831	11834	Presser Foot (hinged) complete, 46 needle hole, in $\frac{3}{8}$ in. gauge, Nos. 202090, 202923 and 230830 ..
229936	11907	Presser Foot (hinged) complete, 46 needle hole, in gauges $\frac{1}{8}$, $\frac{1}{4}$, $\frac{3}{8}$ and $\frac{1}{2}$ in., Nos. 202926, 229184 and 230795. Hinge pin set back $\frac{1}{16}$ in. from regular
221410	-----	Presser Foot (hinged) complete, 46 needle hole, in $\frac{3}{8}$ in. gauge, Nos. 202090, 202923 and 221411 ..
223901	13085	Presser Foot (hinged) complete, 50 needle hole, needles $\frac{3}{16}$ in. apart, in $\frac{1}{16}$ in. gauge, Nos. 202090, 202923 and 223900, for felling ..
223904	11907	Presser Foot (hinged) complete, 50 needle hole, in gauges $\frac{1}{8}$, $\frac{1}{4}$, $\frac{3}{8}$ and $\frac{1}{2}$ in., Nos. 202923, 223903 and 230795, for felling
229167	11907	Presser Foot (hinged) complete, 46 needle hole, in gauges $\frac{1}{8}$, $\frac{1}{4}$, $\frac{3}{8}$ and $\frac{1}{2}$ in., Nos. 202923, 229195 and 230795, for felling
229169	11907	Presser Foot (hinged) complete, 46 needle hole, in gauges $\frac{1}{8}$, $\frac{1}{4}$, $\frac{3}{8}$ and $\frac{1}{2}$ in., Nos. 202923, 229168 and 230795, for felling
229188	11907	Presser Foot (hinged) complete, 46 needle hole, in gauges $\frac{1}{8}$, $\frac{1}{4}$, $\frac{3}{8}$ and $\frac{1}{2}$ in., Nos. 202926, 229164 and 230795. Hinge pin set back $\frac{1}{16}$ in. from regular

No.	Plate	Name
229192	13085	Presser Foot (hinged) complete, 50 needle hole, needles $\frac{3}{16}$ in. apart, in gauges $\frac{1}{8}$, $\frac{1}{4}$ and $\frac{3}{8}$ in., Nos. 202923, 229191 and 230795, for felling
229194	13085	Presser Foot (hinged) complete, 46 needle hole, in gauges $\frac{1}{8}$, $\frac{1}{4}$, $\frac{3}{8}$ and $\frac{1}{2}$ in., Nos. 202923, 229193 and 230795, for felling
229198	11907	Presser Foot (hinged) complete, 46 needle hole, in gauges $\frac{1}{8}$, $\frac{1}{4}$, $\frac{3}{8}$ and $\frac{1}{2}$ in., Nos. 202923, 229197 and 230795, for felling
229202	11908	Presser Foot (hinged) complete, 46 needle hole, in gauges from $\frac{1}{8}$ to $\frac{1}{2}$ in., in steps of $\frac{1}{16}$ in., Nos. 202923, 229201 and 230795, for felling
229204	11908	Presser Foot (hinged) complete, 46 needle hole, in gauges $\frac{3}{16}$, $\frac{1}{4}$, $\frac{3}{8}$ and $\frac{1}{2}$ in., Nos. 202923, 229203 and 230795, for felling
229216	13085	Presser Foot (hinged) complete, 46 needle hole, in gauges $\frac{1}{8}$, $\frac{1}{4}$, $\frac{3}{8}$ and $\frac{1}{2}$ in., Nos. 202926, 229215 and 230795
229218	11907	Presser Foot (hinged) complete, 46 needle hole, in gauges $\frac{1}{8}$, $\frac{3}{8}$ and $\frac{1}{2}$ in., Nos. 202930, 229217 and 230795
229322	11907	Presser Foot (hinged) complete, 46 needle hole, in gauges $\frac{1}{8}$, $\frac{3}{8}$ and $\frac{1}{2}$ in., Nos. 202926, 229321 and 230795. Hinge pin set back $\frac{1}{16}$ in. from regular, for felling ..
229369	11907	Presser Foot (hinged) (long bearing) complete, 46 needle hole, in gauges $\frac{1}{8}$, $\frac{3}{8}$ and $\frac{1}{2}$ in., Nos. 202923, 229368 and 230795, for felling
229561	11908	Presser Foot (hinged) complete, 46 needle hole, in gauges $\frac{1}{8}$, $\frac{1}{4}$, $\frac{3}{8}$ and $\frac{1}{2}$ in., Nos. 202926, 229560 and 230795, for felling
229840	11908	Presser Foot (hinged) complete, 46 needle hole, in gauges $\frac{3}{16}$, $\frac{1}{4}$, $\frac{3}{8}$ and $\frac{1}{2}$ in., Nos. 202926, 229839 and 230795, for felling

No.	Plate	Name
229965	11908	Presser Foot (hinged) complete, 46 needle hole, in gauges from $\frac{1}{8}$ to $\frac{3}{8}$ in., in steps of $\frac{1}{16}$ in., Nos. 202930, 229964 and 230795. Hinge pin set back $\frac{1}{8}$ in. from regular, for felling
222307	11890	Presser Foot (hinged) complete, 46 needle hole, in gauges $\frac{1}{8}$, $\frac{3}{16}$, $\frac{1}{4}$ and $\frac{5}{16}$ in., Nos. 202923, 222306 and 230795, for felling
229932	11870	Presser Foot (auxiliary), 50 needle hole, needles $\frac{3}{32}$ in. apart, in gauges $\frac{3}{32}$, $\frac{1}{8}$ and $\frac{1}{4}$ in., used in place of Roller Presser

THROAT PLATES

No.	Plate	Name
203769	12099	Throat Plate, 53 needle hole, for needle sizes 12 and 13, in gauges $\frac{1}{8}$, $\frac{5}{16}$ and $\frac{3}{8}$ in., for 211714
203778	11814	Throat Plate, 50 needle hole, for needle sizes 14 and 15, in gauges $\frac{1}{4}$ and $\frac{5}{8}$ in., for 212175
211008	11888	Throat Plate, 50 needle hole, for needle sizes 14 and 15, in gauges from $\frac{1}{4}$ to $\frac{3}{4}$ in., in steps of $\frac{1}{8}$ in., for 211010
211018	12100	Throat Plate, 50 needle hole, for needle sizes 14 and 15, in gauges from $\frac{1}{8}$ to $\frac{1}{4}$ in., in steps of $\frac{1}{16}$ in., for 211732 and 211733
211048	11813	Throat Plate, 53 needle hole, for needle sizes 12 and 13, in gauges $\frac{1}{8}$ and $\frac{5}{16}$ in., for 212571
211050	11813	Throat Plate, 46 needle hole, for needle sizes 16 and 18, in gauges $\frac{3}{16}$ and $\frac{1}{4}$ in., for 212571
211052	11813	Throat Plate, 53 needle hole, for needle sizes 12 and 13, in gauges $\frac{1}{4}$ and $\frac{3}{8}$ in., for 236411
211053	11813	Throat Plate, 50 needle hole, for needle sizes 14 and 15, in gauges $\frac{1}{4}$ and $\frac{3}{8}$ in., for 236411
211054	11813	Throat Plate, 46 needle hole, for needle sizes 16 and 18, in gauges $\frac{3}{16}$ and $\frac{1}{4}$ in., for 236411
211056	11813	Throat Plate, 53 needle hole, for needle sizes 12 and 13, in gauges $\frac{3}{16}$ and $\frac{1}{4}$ in., for 211055
211057	11813	Throat Plate, 50 needle hole, for needle sizes 14 and 15, in gauges $\frac{3}{16}$ and $\frac{1}{4}$ in., for 211055
211058	11813	Throat Plate, 46 needle hole, for needle sizes 16 and 18, in gauges $\frac{3}{16}$ and $\frac{1}{4}$ in., for 211055
211059	11814	Throat Plate, 53 needle hole, for needle sizes 12 and 13, in gauges $\frac{1}{8}$ and $\frac{3}{8}$ in., for 236423
211060	11814	Throat Plate, 50 needle hole, for needle sizes 14 and 15, in gauges $\frac{1}{8}$ and $\frac{3}{8}$ in., for 236423

No.	Plate	Name
211061	11814	Throat Plate, 46 needle hole, for needle sizes 16 and 18, in gauges $\frac{1}{16}$ and $\frac{3}{16}$ in., for 236423
211062	11814	Throat Plate, 53 needle hole, for needle sizes 12 and 13, in gauges $\frac{1}{16}$ and $\frac{1}{8}$ in., for 212474
211063	11814	Throat Plate, 50 needle hole, for needle sizes 14 and 15, in gauges $\frac{1}{16}$ and $\frac{1}{8}$ in., for 212474
211064	11814	Throat Plate, 46 needle hole, for needle sizes 16 and 18, in gauges $\frac{1}{16}$ and $\frac{1}{8}$ in., for 212474
211065	11814	Throat Plate, 53 needle hole, for needle sizes 12 and 13, in gauges $\frac{1}{16}$ and $\frac{1}{8}$ in., for 212169
211066	11814	Throat Plate, 50 needle hole, for needle sizes 14 and 15, in gauges $\frac{1}{16}$ and $\frac{1}{8}$ in., for 212169
211067	11814	Throat Plate, 46 needle hole, for needle sizes 16 and 18, in gauges $\frac{1}{16}$ and $\frac{1}{8}$ in., for 212169
211191	12086	Throat Plate, 46 needle hole, for needle sizes 16 and 18, in gauges $\frac{1}{16}$ and $\frac{1}{8}$ in., for 211298 and 211995
211596	11817	Throat Plate, 50 needle hole, for needle sizes 14 and 15, in $\frac{1}{8}$ in. gauge, for 211595
211614	12332	Throat Plate, 50 needle hole, for needle sizes 14 and 15, in gauges $\frac{1}{16}$ and $\frac{1}{8}$ in., for 212571
211625	12085	Throat Plate, 53 needle hole, needles $\frac{1}{16}$ in. apart, for needle sizes 12 and 13, in gauges $\frac{1}{16}$, $\frac{1}{8}$ and $\frac{1}{4}$ in., for 236401
211626	12085	Throat Plate, 53 needle hole, needles $\frac{1}{16}$ in. apart, for needle sizes 12 and 13, in gauges $\frac{1}{16}$, $\frac{1}{8}$ and $\frac{1}{4}$ in., for 236401
211627	12085	Throat Plate, 50 needle hole, needles $\frac{1}{16}$ in. apart, for needle sizes 14 and 15, in gauges $\frac{1}{16}$, $\frac{1}{8}$ and $\frac{1}{4}$ in., for 236401
211629	12085	Throat Plate, 53 needle hole, needles $\frac{1}{16}$ in. apart, for needle sizes 12 and 13, in gauges $\frac{1}{16}$ and $\frac{1}{8}$ in. for 211630
211631	12086	Throat Plate, 53 needle hole, for needle sizes 12 and 13, in gauges $\frac{1}{16}$, $\frac{1}{8}$ and $\frac{1}{4}$ in., for 211632

No.	Plate	Name
211633	12086	Throat Plate, 53 needle hole, for needle sizes 12 and 13, in gauges $\frac{1}{16}$, $\frac{1}{8}$ and $\frac{1}{4}$ in., for 211298 and 211995
211639	11888	Throat Plate, 50 needle hole, needles $\frac{1}{16}$ in. apart, for needle sizes 14 and 15, in gauges $\frac{1}{16}$ and $\frac{1}{8}$ in., for 211640
211649	11888	Throat Plate, 50 needle hole, needles $\frac{1}{16}$ in. apart, for needle sizes 14 and 15, in gauges $\frac{1}{16}$, $\frac{1}{8}$ and $\frac{1}{4}$ in., for 211650
211651	12090	Throat Plate, 50 needle hole, for needle sizes 14 and 15, in gauges $\frac{1}{16}$ and $\frac{1}{8}$ in., for 211652
211653	12090	Throat Plate, 50 needle hole, for needle sizes 14 and 15, in gauges $\frac{1}{16}$ and $\frac{1}{8}$ in., for 211654
211663	12091	Throat Plate, 50 needle hole, for needle sizes 14 and 15, in gauges from $\frac{1}{16}$ to $\frac{1}{4}$ in., in steps of $\frac{1}{32}$ in., for 211665
211664	12091	Throat Plate, 46 needle hole, for needle sizes 16 and 18, in gauges from $\frac{1}{16}$ to $\frac{1}{4}$ in., in steps of $\frac{1}{32}$ in., for 211665
211666	12092	Throat Plate, 50 needle hole, for needle sizes 14 and 15, in gauges $\frac{1}{16}$, $\frac{1}{8}$, $\frac{3}{16}$, $\frac{1}{4}$ and $\frac{1}{2}$ in., for 211669 and 211670
211667	12092	Throat Plate, 46 needle hole, for needle sizes 16 and 18, in gauges $\frac{1}{16}$, $\frac{1}{8}$, $\frac{3}{16}$, $\frac{1}{4}$ and $\frac{1}{2}$ in., for 211669 and 211670
211671	12092	Throat Plate, 50 needle hole, for needle sizes 14 and 15, in gauges $\frac{1}{16}$, $\frac{1}{8}$, $\frac{3}{16}$, $\frac{1}{4}$ and $\frac{1}{2}$ in., for 211674 and 211675
211672	12092	Throat Plate, 46 needle hole, for needle sizes 16 and 18, in gauges $\frac{1}{16}$, $\frac{1}{8}$, $\frac{3}{16}$, $\frac{1}{4}$ and $\frac{1}{2}$ in., for 211674 and 211675
211676	12093	Throat Plate, 50 needle hole, for needle sizes 14 and 15, in gauges $\frac{1}{16}$, $\frac{1}{8}$, $\frac{3}{16}$ and $\frac{1}{4}$ in., for 211679 and 211680
211677	12093	Throat Plate, 46 needle hole, for needle sizes 16 and 18, in gauges $\frac{1}{16}$, $\frac{1}{8}$, $\frac{3}{16}$ and $\frac{1}{4}$ in., for 211679 and 211680

No.	Plate	Name
211681	12093	Throat Plate, 50 needle hole, for needle sizes 14 and 15, in gauges $\frac{3}{32}$ and $\frac{1}{8}$ in., for 211684 and 211685
211682	12093	Throat Plate, 46 needle hole, for needle sizes 16 and 18, in gauges $\frac{3}{32}$ and $\frac{1}{8}$ in., for 211684 and 211685
211713	12099	Throat Plate, 50 needle hole, for needle sizes 14 and 15, in gauges $\frac{1}{32}$ and $\frac{1}{16}$ in., for 211714
211715	12099	Throat Plate, 50 needle hole, for needle sizes 14 and 15, in gauges from $\frac{1}{16}$ to $\frac{1}{8}$ in., in steps of $\frac{1}{32}$ in., for 211717 and 211718
211716	12099	Throat Plate, 46 needle hole, for needle sizes 16 and 18, in gauges from $\frac{1}{32}$ to $\frac{1}{8}$ in., in steps of $\frac{1}{32}$ in., for 211717 and 211718
211719	12099	Throat Plate, 50 needle hole, for needle sizes 14 and 15, in gauges from $\frac{1}{16}$ to $\frac{1}{8}$ in., in steps of $\frac{1}{32}$ in., for 211721 and 211722
211720	12099	Throat Plate, 46 needle hole, for needle sizes 16 and 18, in gauges from $\frac{1}{32}$ to $\frac{1}{8}$ in., in steps of $\frac{1}{32}$ in., for 211721 and 211722
211723	12100	Throat Plate, 50 needle hole, for needle sizes 14 and 15, in gauges from $\frac{1}{16}$ to $\frac{1}{8}$ in., in steps of $\frac{1}{32}$ in., for 211725
211724	12100	Throat Plate, 46 needle hole, for needle sizes 16 and 18, in gauges from $\frac{1}{16}$ to $\frac{1}{8}$ in., in steps of $\frac{1}{32}$ in., for 211725
211726	12100	Throat Plate, 50 needle hole, for needle sizes 14 and 15, in gauges from $\frac{1}{16}$ to $\frac{3}{16}$ in., in steps of $\frac{1}{32}$ in., for 211246, 211728 and 211729
211727	12100	Throat Plate, 46 needle hole, for needle sizes 16 and 18, in gauges from $\frac{1}{16}$ to $\frac{3}{16}$ in., in steps of $\frac{1}{32}$ in., for 211246, 211728 and 211729
211731	12100	Throat Plate, 46 needle hole, for needle sizes 16 and 18, in gauges from $\frac{1}{32}$ to $\frac{1}{8}$ in., in steps of $\frac{1}{32}$ in., for 211732 and 211733
211737	11888	Throat Plate, 46 needle hole, for needle sizes 16 and 18, in gauges from $\frac{1}{4}$ to $\frac{1}{2}$ in., in steps of $\frac{1}{32}$ in., for 211739 and 211740

No.	Plate	Name
211748	11888	Throat Plate, 46 needle hole, for needle sizes 16 and 18, in gauges from $\frac{1}{16}$ to $\frac{3}{16}$ in., in steps of $\frac{1}{32}$ in., for 211010
211749	11818	Throat Plate, 50 needle hole, for needle sizes 14 and 15, in gauges $\frac{1}{16}$, $\frac{1}{8}$, $\frac{3}{16}$ and $\frac{1}{4}$ in., for 211765, 211766 and 211933
211750	11819	Throat Plate, 50 needle hole, for needle sizes 14 and 15, in $\frac{1}{32}$ in. gauge, for 212154
211755	12103	Throat Plate, 50 needle hole, for needle sizes 14 and 15, in gauges from $\frac{1}{32}$ to $\frac{3}{16}$ in., in steps of $\frac{1}{32}$ in., for 211756
211757	12103	Throat Plate, 50 needle hole, for needle sizes 14 and 15, in gauges $\frac{1}{32}$, $\frac{1}{8}$ and $\frac{1}{16}$ in., for 211758
211759	12103	Throat Plate, 50 needle hole, for needle sizes 14 and 15, in gauges $\frac{1}{16}$, $\frac{1}{8}$, $\frac{3}{16}$ and $\frac{1}{4}$ in., for 211761 and 211762
211760	12103	Throat Plate, 46 needle hole, for needle sizes 16 and 18, in gauges $\frac{1}{16}$, $\frac{1}{8}$, $\frac{3}{16}$ and $\frac{1}{4}$ in., for 211761 and 211762
211763	12104	Throat Plate, 50 needle hole, for needle sizes 14 and 15, in gauges $\frac{1}{16}$, $\frac{1}{8}$, $\frac{3}{16}$ and $\frac{1}{4}$ in., for 211765, 211766 and 211933
211764	12104	Throat Plate, 46 needle hole, for needle sizes 16 and 18, in gauges $\frac{1}{16}$, $\frac{1}{8}$, $\frac{3}{16}$ and $\frac{1}{4}$ in., for 211765, 211766 and 211933
211767	12104	Throat Plate, 50 needle hole, for needle sizes 14 and 15, in $\frac{1}{8}$ in. gauge, for 211769, 211770 and 211934
211768	12104	Throat Plate, 46 needle hole, for needle sizes 16 and 18, in $\frac{1}{8}$ in. gauge, for 211769, 211770 and 211934
211771	11815	Throat Plate, 50 needle hole, for needle sizes 14 and 15, in $\frac{3}{16}$ in. gauge, for 212836
211773	11815	Throat Plate, 53 needle hole, for needle sizes 12 and 13, in $\frac{1}{16}$ in. gauge, for 212834

No.	Plate	Name
211774	11815	Throat Plate, 50 needle hole, for needle sizes 14 and 15, in $\frac{5}{16}$ in. gauge, for 212834
211776	12106	Throat Plate, 50 needle hole, for needle sizes 14 and 15, in gauges $\frac{3}{32}$, $\frac{1}{8}$ and $\frac{5}{32}$ in., for 211778
211777	12106	Throat Plate, 46 needle hole, for needle sizes 16 and 18, in gauges $\frac{3}{32}$, $\frac{1}{8}$ and $\frac{5}{32}$ in., for 211778
211779	12106	Throat Plate, 50 needle hole, for needle sizes 14 and 15, in gauges $\frac{3}{16}$, $\frac{5}{32}$ and $\frac{1}{4}$ in., for 211781
211780	12106	Throat Plate, 46 needle hole, for needle sizes 16 and 18, in gauges $\frac{3}{16}$, $\frac{5}{32}$ and $\frac{1}{4}$ in., for 211781
211810	12111	Throat Plate, 50 needle hole, for needle sizes 14 and 15, in gauges $\frac{3}{32}$, $\frac{1}{8}$ and $\frac{5}{32}$ in., for 211811
211812	12111	Throat Plate, 50 needle hole, for needle sizes 14 and 15, in gauges $\frac{3}{16}$ and $\frac{1}{4}$ in., for 211813
211814	12112	Throat Plate, 50 needle hole, for needle sizes 14 and 15, in $\frac{1}{8}$ in. gauge, for 211815
211816	12112	Throat Plate, 50 needle hole, for needle sizes 14 and 15, in gauges from $\frac{3}{16}$ to $\frac{7}{16}$ in., in steps of $\frac{1}{32}$ in., for 211732 and 211733
		Note: When ordering 211816, furnish sample of strip and state gauge required.
211817	12112	Throat Plate, 50 needle hole, for needle sizes 14 and 15, in gauges from $\frac{3}{16}$ to $\frac{7}{16}$ in., in steps of $\frac{1}{32}$ in., for 211732 and 211733
		Note: When ordering 211817, furnish sample of strip and state gauge required.
211818	12112	Throat Plate, 50 needle hole, for needle sizes 14 and 15, in gauges from $\frac{3}{16}$ to $\frac{7}{16}$ in., in steps of $\frac{1}{32}$ in., for 211732 and 211733
		Note: When ordering 211818, furnish sample of strip and state gauge required.
211819	12112	Throat Plate, 50 needle hole, for needle sizes 14 and 15, in gauges from $\frac{1}{4}$ to $\frac{7}{16}$ in., in steps of $\frac{1}{32}$ in., for 211820
		Note: When ordering 211819, furnish sample of strip and state gauge required.

No.	Plate	Name
211821	12113	Throat Plate, 50 needle hole, for needle sizes 14 and 15, in gauges $\frac{1}{8}$, $\frac{3}{16}$, $\frac{5}{16}$, $\frac{1}{2}$ and $\frac{3}{4}$ in., with 211822, for 211823
		Note: When ordering 211821, furnish sample of strip and state gauge required.
211822	12113	Throat Plate Strip Guide, for 211821, 211837 and 211839
211824	12113	Throat Plate, 50 needle hole, for needle sizes 14 and 15, in gauges from $\frac{3}{16}$ to $\frac{7}{16}$ in., in steps of $\frac{1}{32}$ in., for 211010
		Note: When ordering 211824, furnish sample of strip and state gauge required.
211825	12113	Throat Plate, 50 needle hole, for needle sizes 14 and 15, in gauges from $\frac{3}{16}$ to $\frac{7}{16}$ in., in steps of $\frac{1}{32}$ in., for 211010
		Note: When ordering 211825, furnish sample of strip and state gauge required.
211826	12113	Throat Plate, 50 needle hole, for needle sizes 14 and 15, in gauges $\frac{1}{8}$, $\frac{1}{16}$, $\frac{3}{16}$, $\frac{1}{2}$ and $\frac{3}{4}$ in., with 211827, for 211000
		Note: When ordering 211826, furnish sample of strip and state gauge required.
211827	12113	Throat Plate Strip Guide, for 211826
211828	12114	" " 50 needle hole, for needle sizes 14 and 15, in gauges $\frac{3}{16}$, $\frac{5}{16}$ and $\frac{1}{4}$ in., for 211829
211830	12114	Throat Plate, 50 needle hole, for needle sizes 14 and 15, in gauges $\frac{1}{8}$, $\frac{1}{16}$, $\frac{3}{16}$, $\frac{1}{2}$ and $\frac{3}{4}$ in., for 211761 and 211762
		Note: When ordering 211830, furnish sample of strip and state gauge required.
211831	12114	Throat Plate, 50 needle hole, for needle sizes 14 and 15, in $\frac{5}{8}$ in. gauge, for 211014
211834	12115	Throat Plate, 50 needle hole, for needle sizes 14 and 15, in gauges from $\frac{3}{8}$ to $\frac{5}{8}$ in., in steps of $\frac{1}{32}$ in., for 211000
		Note: When ordering 211834, furnish sample of strip and state gauge required.
211835	12115	Throat Plate, 50 needle hole, for needle sizes 14 and 15, in gauges $\frac{1}{8}$, $\frac{3}{16}$ and $\frac{5}{16}$ in., for 211836

No.	Plate	Name
211837	12115	Throat Plate, 50 needle hole, for needle sizes 14 and 15, in $\frac{1}{16}$ in. gauge, with 211822, for 211838..
211839	12116	Throat Plate, 50 needle hole, for needle sizes 14 and 15, in $\frac{1}{8}$ in. gauge, with 211822, for 211840..
211843	12116	Throat Plate, 50 needle hole, for needle sizes 14 and 15, in gauges $\frac{3}{32}$, $\frac{1}{4}$ and $\frac{5}{32}$ in., for 211844
211845	12117	Throat Plate, 50 needle hole, for needle sizes 14 and 15, in gauges $\frac{3}{16}$, $\frac{1}{4}$, $\frac{5}{16}$ and $\frac{3}{8}$ in., for 211815..
211846	12117	Throat Plate, 50 needle hole, for needle sizes 14 and 15, in gauges $\frac{3}{16}$, $\frac{1}{4}$, $\frac{5}{16}$ and $\frac{3}{8}$ in., for 211847 ..
211848	12118	Throat Plate, 50 needle hole, for needle sizes 14 and 15, in gauges from $\frac{1}{4}$ to $\frac{11}{16}$ in., in steps of $\frac{1}{32}$ in., for 211043 and 211786
211849	12118	Throat Plate, 50 needle hole, for needle sizes 14 and 15, in $\frac{3}{16}$ in. gauge, for 211836
211850	12119	Throat Plate, 50 needle hole, for needle sizes 14 and 15, in $\frac{1}{16}$ in. gauge, for 211851
211852	12119	Throat Plate, 50 needle hole, for needle sizes 14 and 15, in gauges $\frac{1}{4}$, $\frac{5}{16}$ and $\frac{3}{8}$ in., for 211853
211854	12120	Throat Plate, 50 needle hole, for needle sizes 14 and 15, in gauges $\frac{1}{4}$, $\frac{5}{16}$, $\frac{3}{8}$, $\frac{1}{2}$ and $\frac{3}{4}$ in., for 211855
211856	12120	Throat Plate, 50 needle hole, for needle sizes 14 and 15, in gauges $\frac{1}{4}$, $\frac{5}{16}$, $\frac{3}{8}$, $\frac{1}{2}$ and $\frac{3}{4}$ in., for 211857
211859	12090	Throat Plate, 46 needle hole, for needle sizes 16 and 18, in gauges $\frac{3}{32}$ and $\frac{1}{4}$ in., for 211652
211870	11888	Throat Plate, 50 needle hole, for needle sizes 14 and 15, in gauges from $\frac{1}{4}$ to $\frac{1}{2}$ in., in steps of $\frac{1}{32}$ in., for 211739 and 211740
211878	12085	Throat Plate, 50 needle hole, needles $\frac{3}{32}$ in. apart, for needle sizes 14 and 15, in gauges $\frac{3}{32}$, $\frac{1}{4}$ and $\frac{5}{16}$ in., for 236401
211879	12086	Throat Plate, 50 needle hole, for needle sizes 14 and 15, in gauges $\frac{3}{32}$, $\frac{1}{4}$ and $\frac{5}{16}$ in., for 211298 and 211995

No.	Plate	Name
211903	12086	Throat Plate, 53 needle hole, for needle sizes 12 and 13, in gauges $\frac{3}{32}$, $\frac{1}{4}$ and $\frac{5}{16}$ in., for 211904
211906	12085	Throat Plate, 60 needle hole, for needle sizes 8 and 9, in gauges $\frac{1}{16}$ and $\frac{3}{32}$ in., for 211630
211908	11816	Throat Plate, 50 needle hole, for needle sizes 14 and 15, in $\frac{1}{4}$ in. gauge, for 211883
211911	11816	Throat Plate, 50 needle hole, for needle sizes 14 and 15, in gauges from $\frac{1}{4}$ to $\frac{3}{4}$ in., in steps of $\frac{1}{32}$ in., for 211043 and 211786
211915	11816	Throat Plate, 50 needle hole, for needle sizes 14 and 15, in gauges from $\frac{1}{4}$ to $\frac{3}{4}$ in., in steps of $\frac{1}{32}$ in., for 211043 and 211786
211918	11818	Throat Plate, 50 needle hole, for needle sizes 14 and 15, in gauges from $\frac{1}{4}$ to $\frac{3}{8}$ in., in steps of $\frac{1}{32}$ in., for 211920
211919	11818	Throat Plate, 46 needle hole, for needle sizes 16 and 18, in gauges from $\frac{1}{4}$ to $\frac{3}{8}$ in., in steps of $\frac{1}{32}$ in., for 211920
211922	11819	Throat Plate, 50 needle hole, for needle sizes 14 and 15, in gauges $\frac{3}{32}$, $\frac{1}{4}$ and $\frac{5}{16}$ in., for 211921
211972	11816	Throat Plate, 50 needle hole, for needle sizes 14 and 15, in $\frac{3}{16}$ in. gauge, for 211971
212091	12086	Throat Plate, 46 needle hole, for needle sizes 16 and 18, in $\frac{1}{4}$ in. gauge, for 211904
212170	12085	Throat Plate, 50 needle hole, needles $\frac{1}{4}$ in. apart, for needle sizes 14 and 15, in gauges $\frac{3}{32}$, $\frac{1}{4}$ and $\frac{5}{16}$ in., for 211630
212172	11815	Throat Plate, 50 needle hole, for needle sizes 14 and 15, in gauges $\frac{3}{32}$ and $\frac{1}{16}$ in., for 212159
212204	11817	Throat Plate, 50 needle hole, for needle sizes 14 and 15, in gauges from $\frac{3}{32}$ to $\frac{1}{16}$ in., in steps of $\frac{1}{32}$ in., for 212205
212218	12085	Throat Plate, 46 needle hole, needles $\frac{3}{32}$ in. apart, for needle sizes 16 and 18, in $\frac{1}{16}$ in. gauge, for 236401

No.	Plate	Name
213850	11818	Throat Plate, 50 needle hole, for needle sizes 14 and 15, in gauges from $\frac{1}{16}$ to $\frac{7}{16}$ in., in steps of $\frac{1}{32}$ in., for 211730, 211732 and 211733
221451	11817	Throat Plate, 50 needle hole, for needle sizes 14 and 15, in gauges $\frac{3}{32}$ and $\frac{1}{4}$ in., for 221452
221453	11815	Throat Plate, 50 needle hole, for needle sizes 14 and 15, in gauges $\frac{1}{2}$, $\frac{11}{16}$ and $\frac{3}{4}$ in., for 211941
230601	11819	Throat Plate, 50 needle hole, for needle sizes 14 and 15, in gauges $\frac{3}{8}$ and $\frac{1}{2}$ in., for 230602
222217	11818	Throat Plate, 50 needle hole, for needle sizes 14 and 15, in gauges from $\frac{1}{2}$ to $\frac{3}{4}$ in., in steps of $\frac{1}{16}$ in., for 211762

LAP SEAM FELLER

Note: In ordering Lap Seam Feller, give letter which refers to material to be used, in addition to the number.

	F	Silks, fine muslin, etc., where there are no seams.
	L	Fine shirts, underwear, corsets, etc.
	M	General shirt and corset work, etc.
	MH	Heavy corset and other medium heavy material.
	H	Heavy shirt work, light overalls, etc.
230048	11851	Lap Seam Feller on Shank (right hand). For general work. For $\frac{1}{8}$ to 1 in. gauge machines. For F, L, M, MH or H material. Has yielding spring

OBSOLETE PARTS

No.	Plate	Name
202470	12320	Bobbin Winder Base
202471	12320	" " Frame
202472	12319	" " " Spring
202474	12320	" " Spindle
202477	12319	" " Stop Latch Thumb Lever
202480	12320	Bobbin Winder Spool Holder Base with 200355H and 202484
202481	12320	Bobbin Winder Spool Holder Base Spool Pin
202482	12319	Bobbin Winder Spool Holder Tension Disc (lower or upper)
202483	12319	Bobbin Winder Spool Holder Tension Disc Spring (brass)
202484	12319	Bobbin Winder Spool Holder Tension Disc Thread Guide
202485	12320	Bobbin Winder Spool Holder complete, Nos. 200011E, 202480, 202481, 202483, two 202482 and one wood screw 1 in., No. 13
227522	12319	Bobbin Winder Stop Latch
227523	12320	Bobbin Winder complete, Nos. 200056E, 200161D, 200221D, 201537H, 202470 to 202474, 202477, 202478, 227522, three 200299H and two round head wood screws 1 in., No. 13
211615	12332	Feed Dog, for 211614
211634	12086	" " " 211633
211636	12087	" " " 211635
211638	12087	" " " 211637
211656	12090	" " " 211655
211659	12091	" " " 211657 and 211658
211662	12091	" " " 211660 and 211661
211941	11815	" " " 221453
*213605	---	" Driving Cam Fork Lever Slide Block
*213604	---	Feed Driving Cam Fork Lever Slide Block with 200116c
213606	11889	Feed Driving Cam Fork Lever Slide Block 213604 with 213605
203250	11007	Hook Driving Shaft Collar with two 200393c

No.	Plate	Name
204870	12333	Needle Bar (hollow)
203697	11889	" Holder, needles $\frac{3}{32}$ in. apart and must be set diagonally, in gauges $\frac{1}{32}$, $\frac{3}{64}$ and $\frac{1}{16}$ in., with 200068H and two 200141F
203701	11889	Needle Holder, needles $\frac{3}{32}$ in. apart and must be set diagonally, in gauges $\frac{1}{16}$, $\frac{3}{32}$, $\frac{1}{8}$ and $\frac{1}{4}$ in., with 200068H and two 200141F
203702	11889	Needle Holder, needles $\frac{1}{4}$ in. apart and must be set diagonally, in gauges $\frac{1}{32}$, $\frac{3}{64}$, $\frac{1}{16}$ and $\frac{3}{32}$ in., with 200068H and two 200141F, for Machine No. 22w1
203703	11889	Needle Holder, in gauges $\frac{3}{32}$, $\frac{1}{4}$ and $\frac{5}{32}$ in., with 200068H and two 200141F
203704	11889	Needle Holder, in gauges from $\frac{3}{16}$ to $\frac{1}{2}$ in., in steps of $\frac{1}{32}$ in., with 200068H and two 200141F
203705	11889	Needle Holder, in gauges from $\frac{1}{4}$ to $\frac{3}{4}$ in., in steps of $\frac{1}{8}$ in., with 200068H and two 200141F
203713	11889	Needle Holder, in gauges from $\frac{3}{8}$ to $\frac{1}{2}$ in., in steps of $\frac{1}{32}$ in., with 200068H and two 200141F, for Machine No. 22w1
230780	11889	Needle Holder, in gauges from $\frac{3}{4}$ to $\frac{1}{2}$ in., in steps of $\frac{1}{32}$ in., with 200068H and two 200141F, for Machine No. 22w1
211635	12087	Throat Plate, 50 needle hole, for needle sizes 14 and 15, in gauges $\frac{3}{32}$, $\frac{1}{4}$ and $\frac{5}{32}$ in., for 211636
211637	12087	Throat Plate, 50 needle hole, for needle sizes 14 and 15, in gauges $\frac{3}{32}$, $\frac{1}{8}$ and $\frac{3}{16}$ in., for 211638
211655	12090	Throat Plate, 50 needle hole, for needle sizes 14 and 15, in gauges from $\frac{3}{32}$ to $\frac{1}{16}$ in., in steps of $\frac{1}{32}$ in., for 211656
211657	12091	Throat Plate, 50 needle hole, for needle sizes 14 and 15, in gauges $\frac{3}{32}$, $\frac{1}{4}$ and $\frac{5}{32}$ in., for 211659
211658	12091	Throat Plate, 46 needle hole, for needle sizes 16 and 18, in gauges $\frac{3}{32}$, $\frac{1}{4}$ and $\frac{5}{32}$ in., for 211659

No.	Plate	Name
211660	12091	Throat Plate, 50 needle hole, for needle sizes 14 and 15, in gauges $\frac{3}{32}$, $\frac{1}{8}$ and $\frac{1}{16}$ in., for 211662
211661	12091	Throat Plate, 46 needle hole, for needle sizes 16 and 18, in gauges $\frac{3}{32}$, $\frac{1}{8}$ and $\frac{1}{16}$ in., for 211662
211945	11889	Throat Plate, 50 needle hole, for needle sizes 14 and 15, in gauges from $\frac{3}{16}$ to $\frac{1}{4}$ in., in steps of $\frac{1}{32}$ in., for 211732 and 211733

PLATE 10838—ONE-EIGHTH SIZE

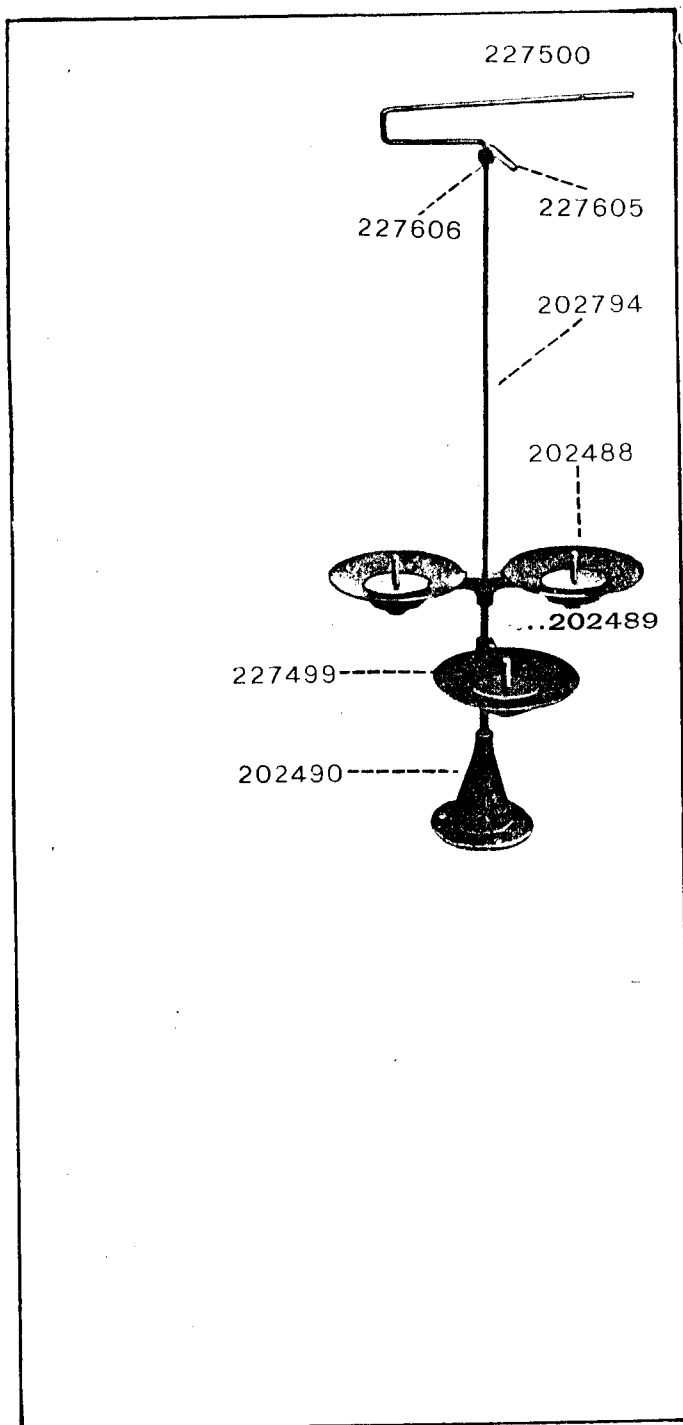
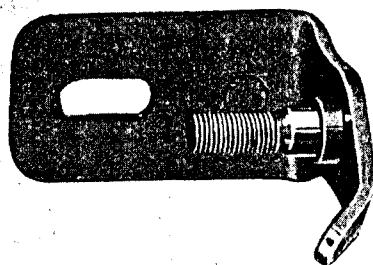
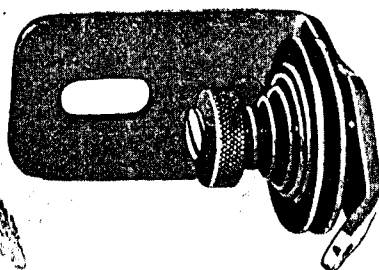


PLATE 10881—FULL SIZE

225461



225462



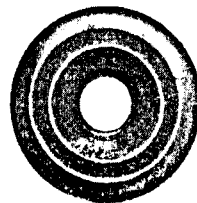
200082



202104



2102



202407



201499

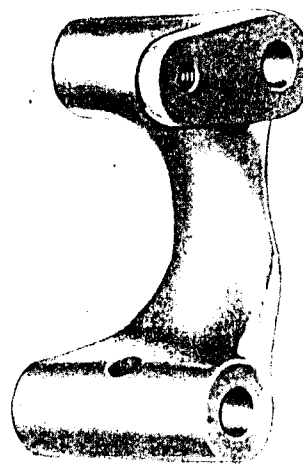


201572

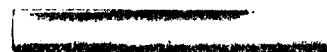


PLATE 10882—FULL SIZE

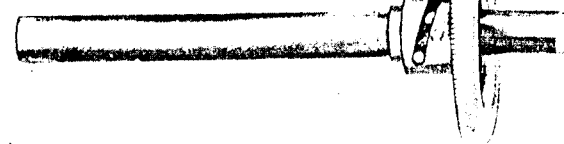
225453



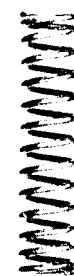
225454



225452



225455



225456



225438



200380



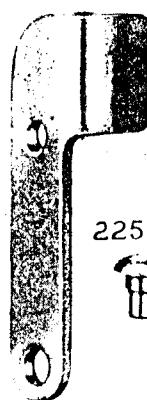
200056



200299



225458



225459



202478



225460



225444

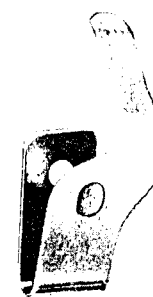


PLATE 10883 ONE-FOURTH SIZE

225433



202473



225436

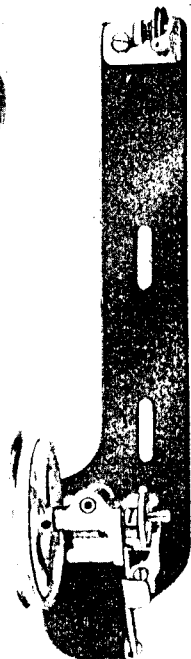
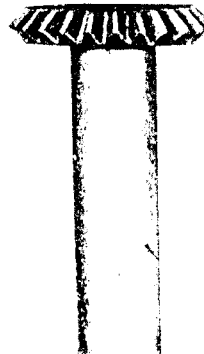


PLATE 11007-FULL SIZE

203241



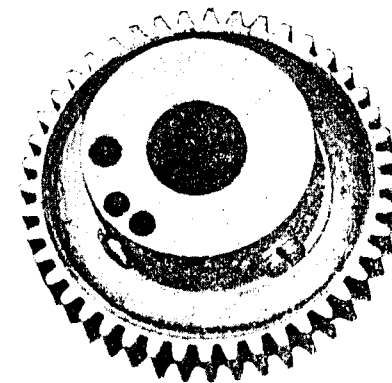
200555



203242



203245



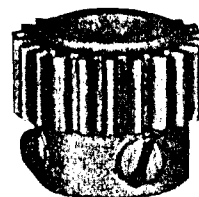
203250



200393



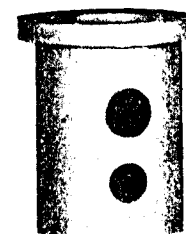
203246



200006



203249



225585



203244



200840



PLATE 11125 - ONE-FOURTH SIZE

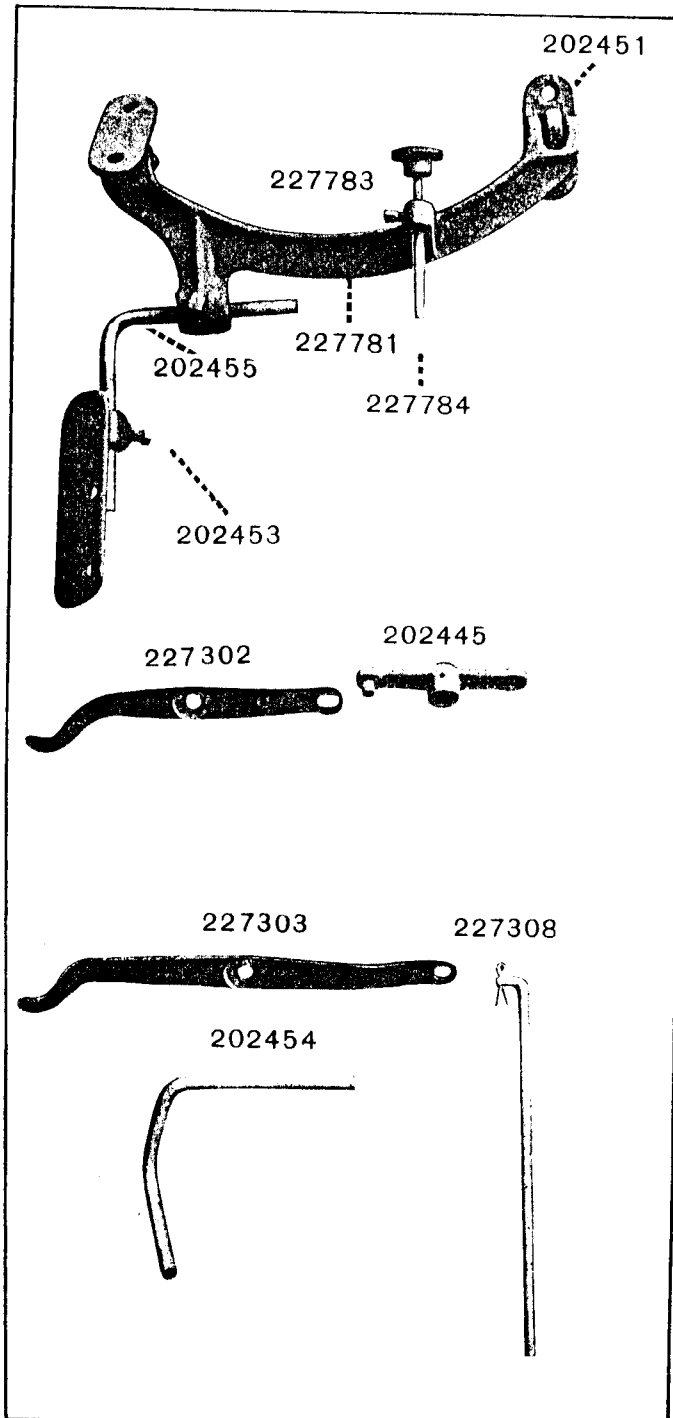


PLATE 11813 - FULL SIZE

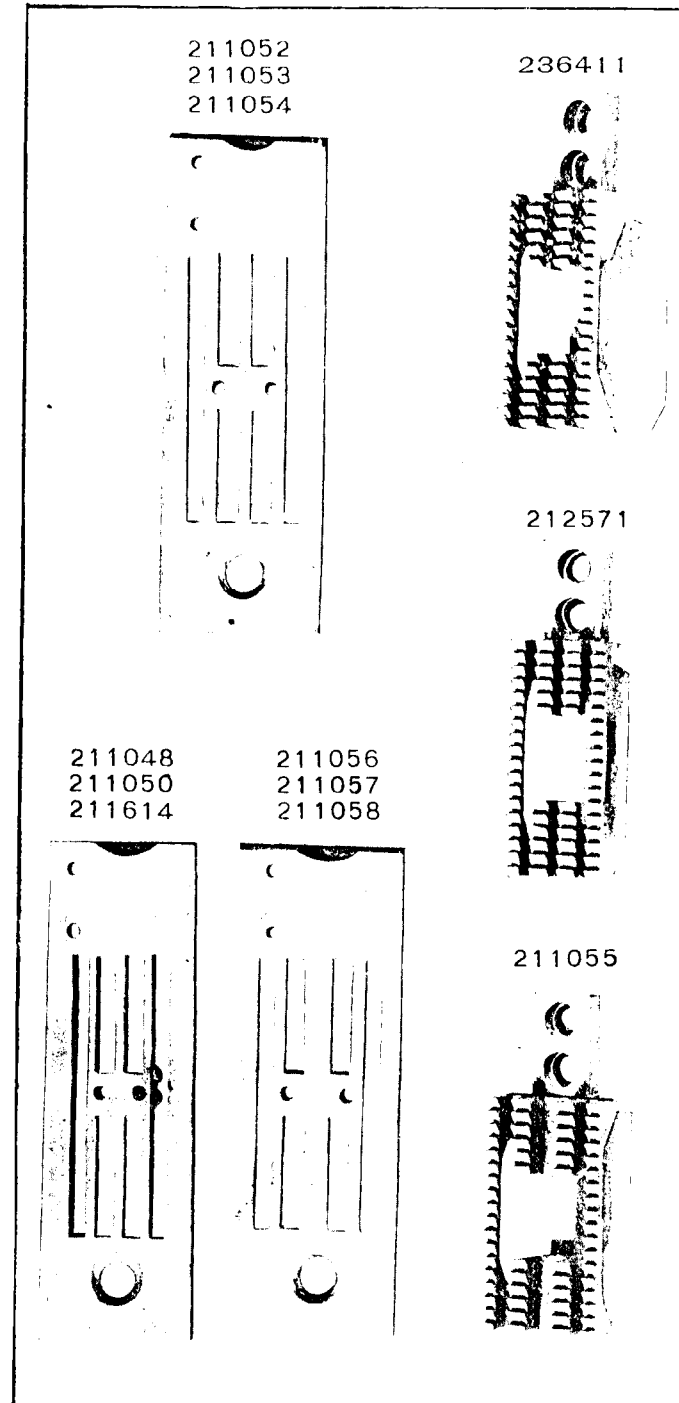


PLATE 11814 -FULL SIZE

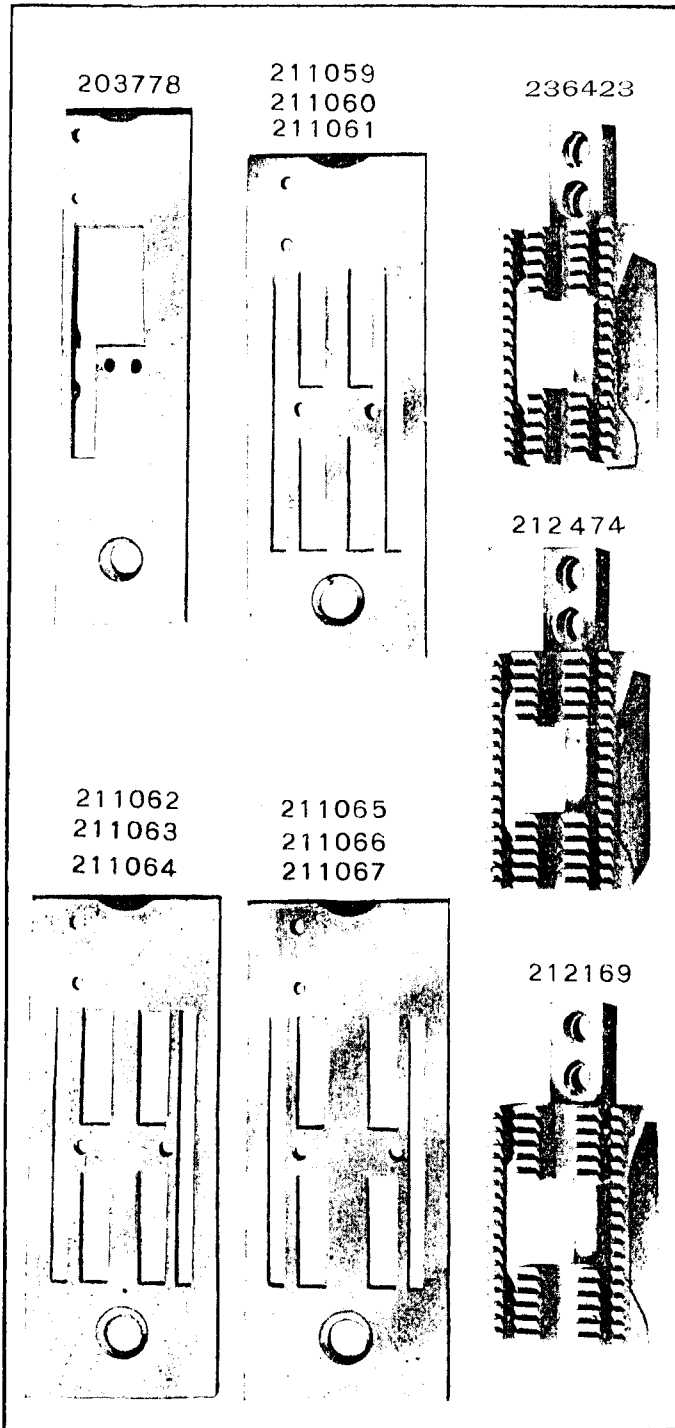


PLATE 11815 -FULL SIZE

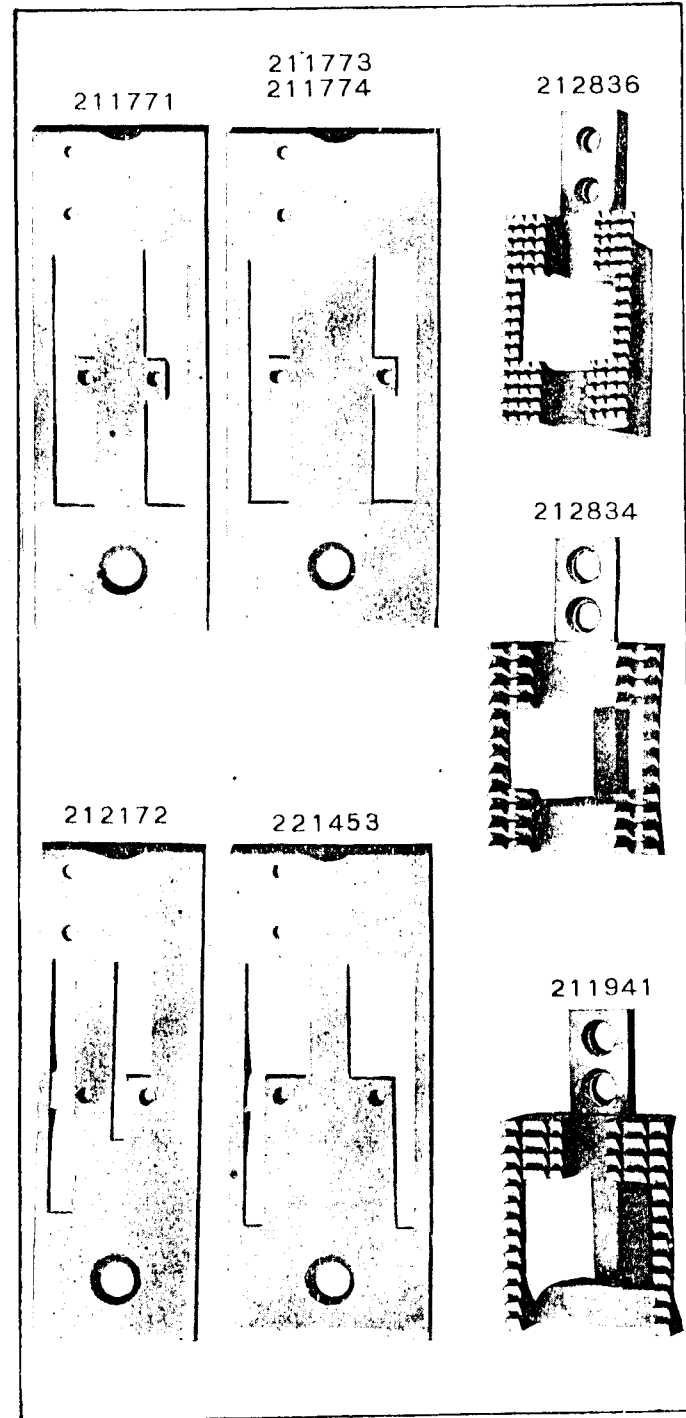


PLATE 11816 -FULL SIZE

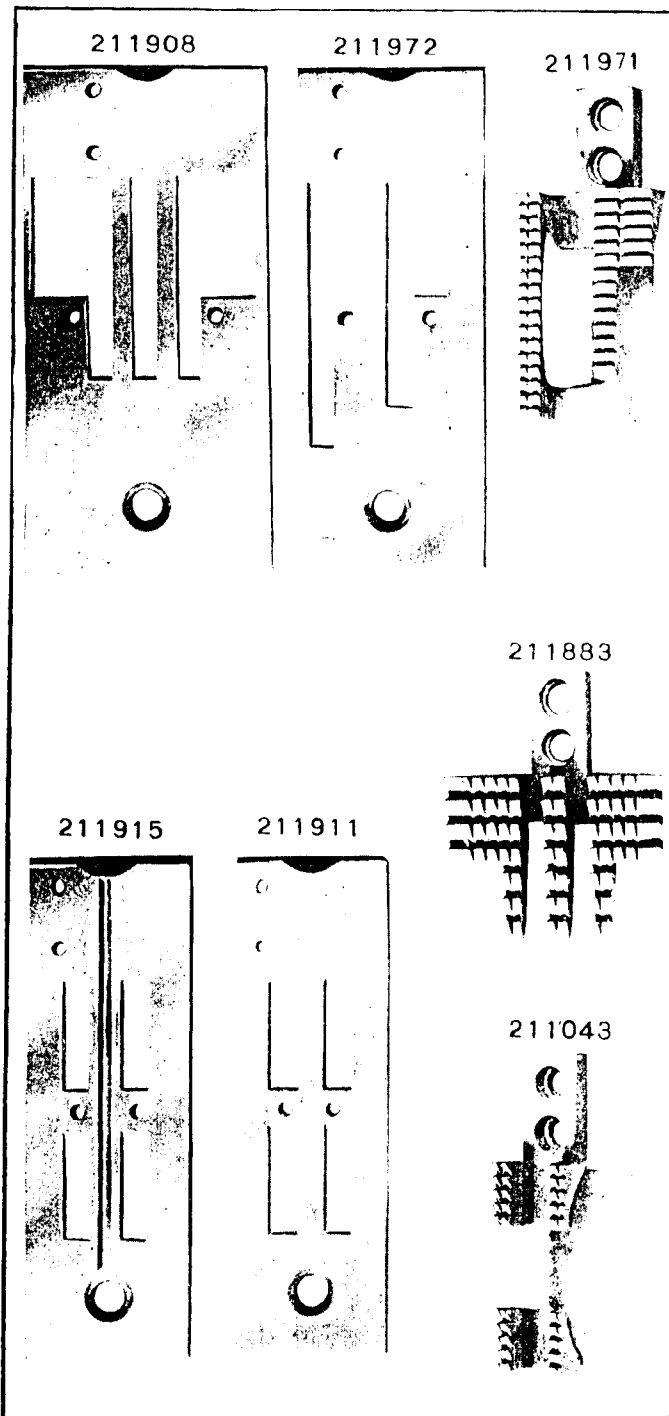


PLATE 11817 -FULL SIZE

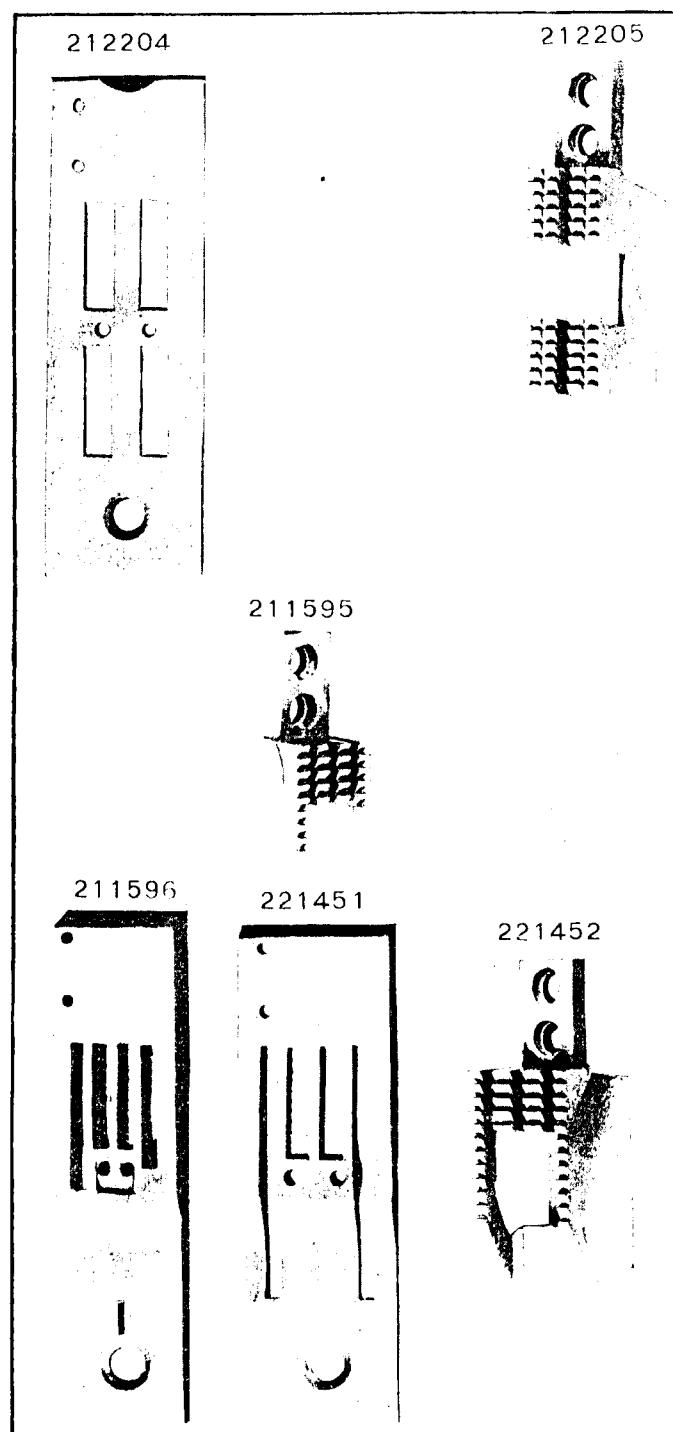
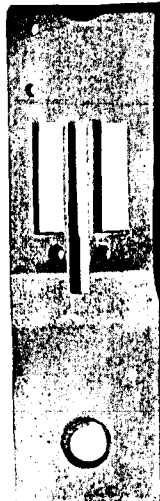
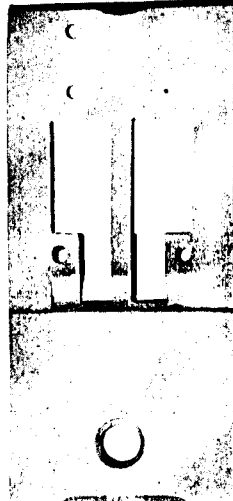


PLATE 11818 - FULL SIZE

211918
211919



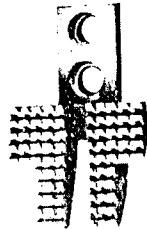
211749



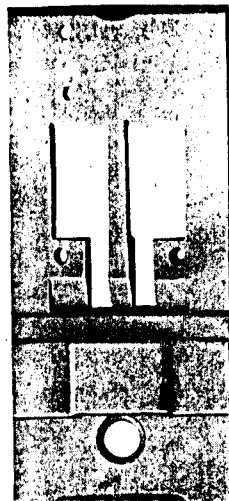
211920



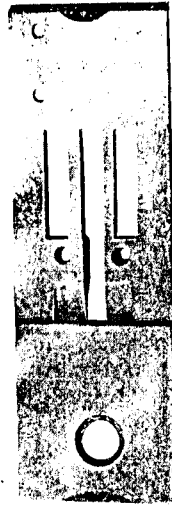
211933



222217



213850

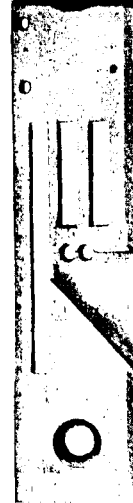


211730

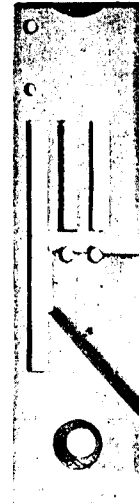


PLATE 11819 - FULL SIZE

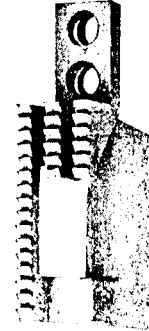
211922



230601



211921



230602



211750



211000



PLATE 11833 -FULL SIZE

229008



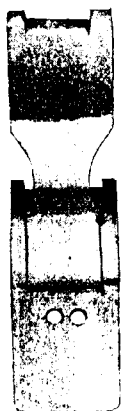
229092



222226



229094



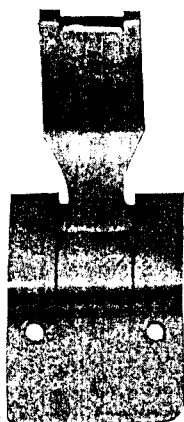
229096



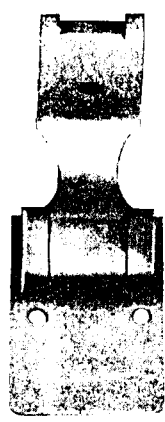
229098



229100



229139



229141

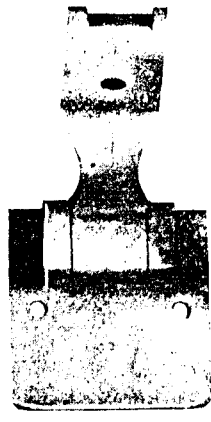


PLATE 11834 -FULL SIZE

229296



229542



202989



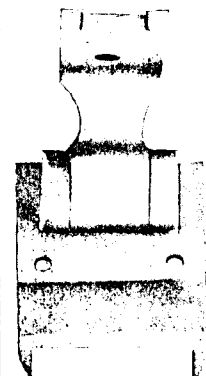
229513



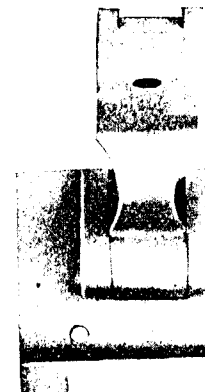
229541



229515



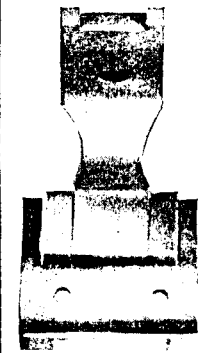
230831



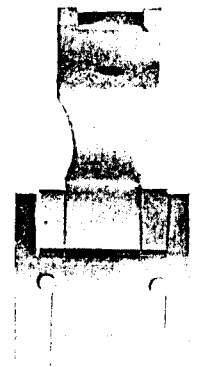
230697



229012



229015



229286

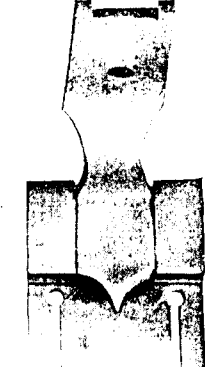


PLATE 11835 -FULL SIZE

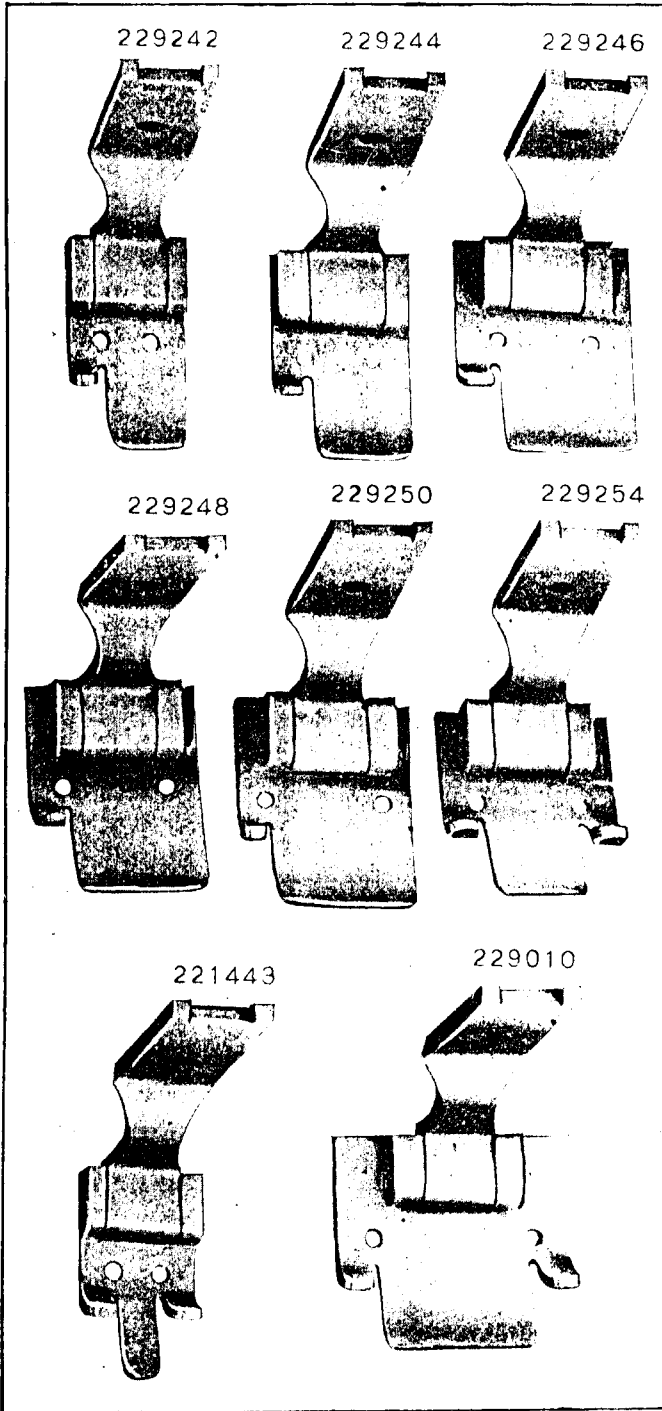


PLATE 11851 -FULL SIZE

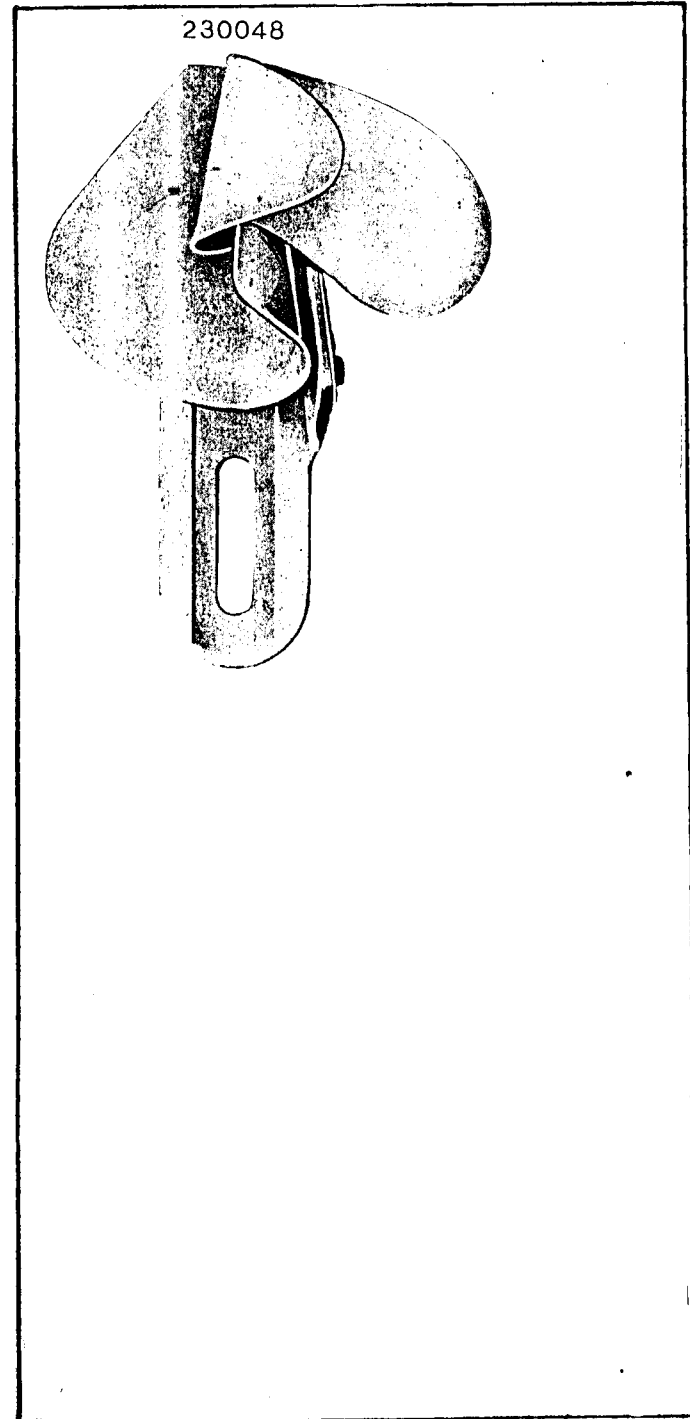


PLATE 11886—ONE-HALF SIZE

231390



203329

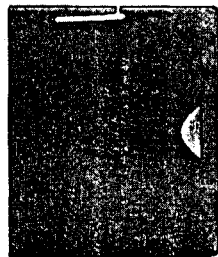


PLATE 11887—FULL SIZE

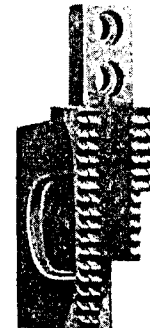
212154



211298



212159



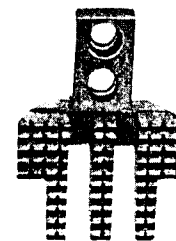
211786



211246



211934



211995

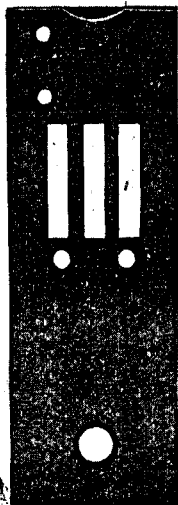


212175



PLATE 11888—FULL SIZE

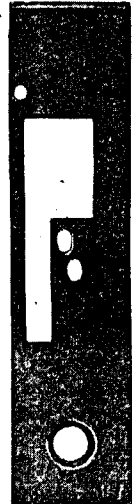
211008
211748



211010



211649



211650



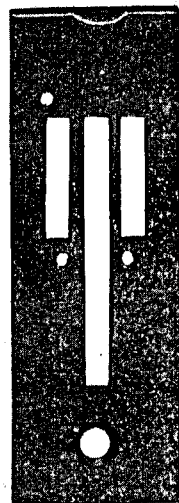
211639



211640



211737
211870



211740



211739

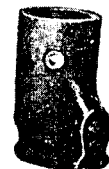


PLATE 11889—FULL SIZE

203701



203702



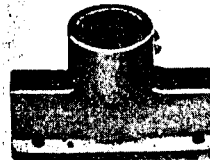
203703



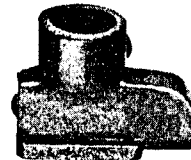
203704



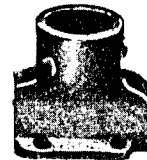
203705



230780



203713



203697



213606



211945

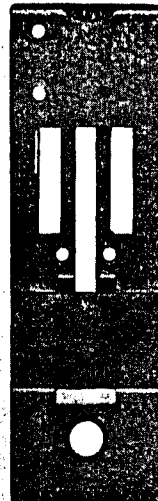


PLATE 11890 - FULL SIZE

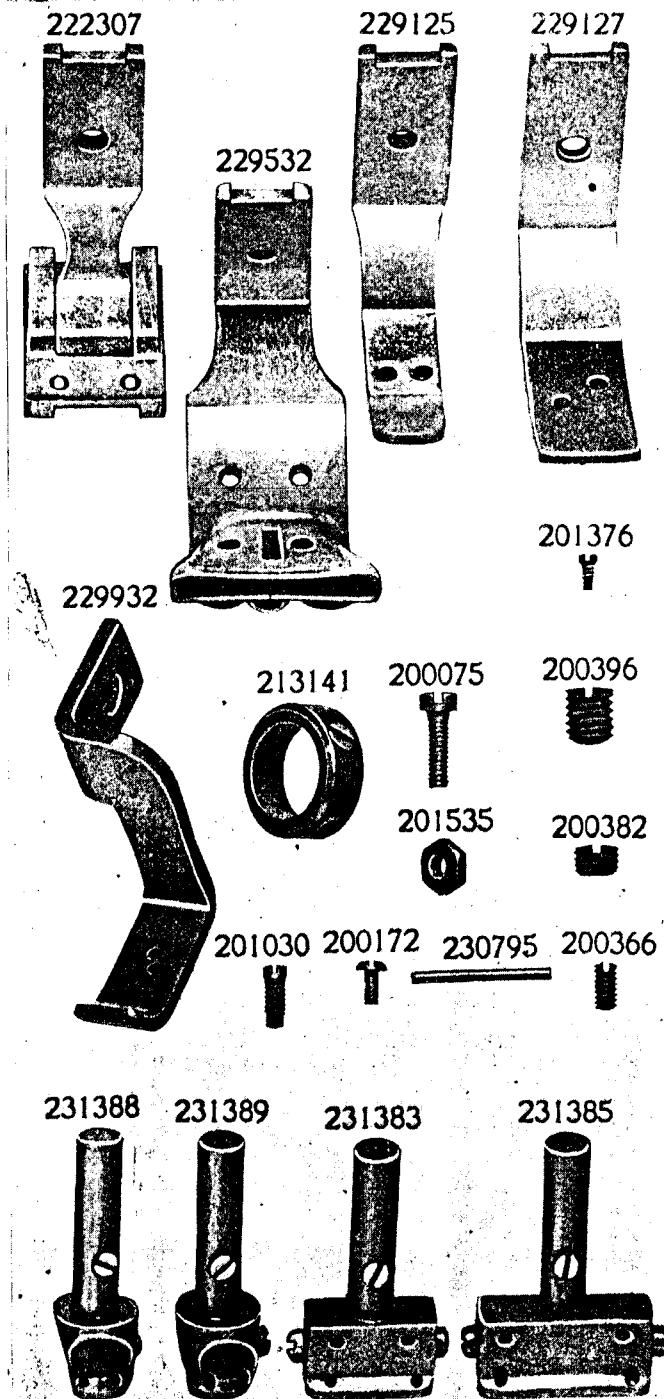


PLATE 11907 - FULL SIZE

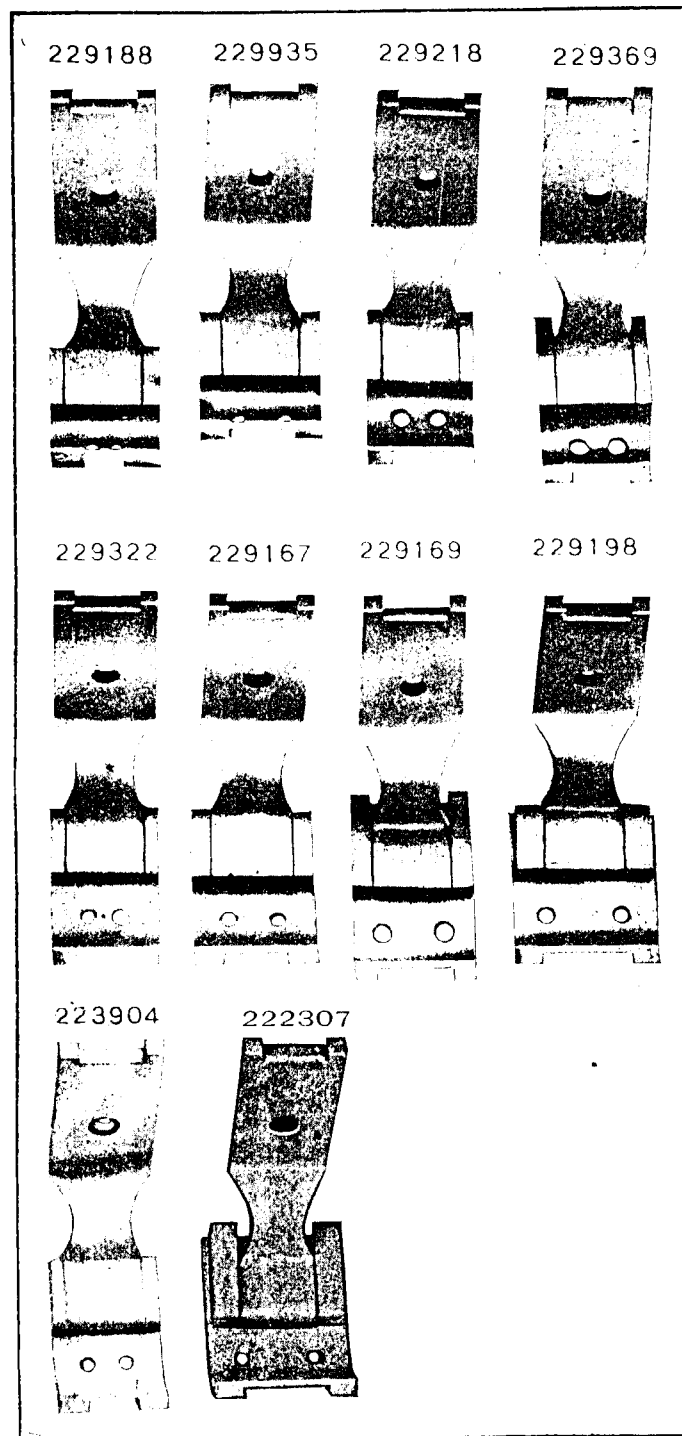


PLATE 11908 -FULL SIZE

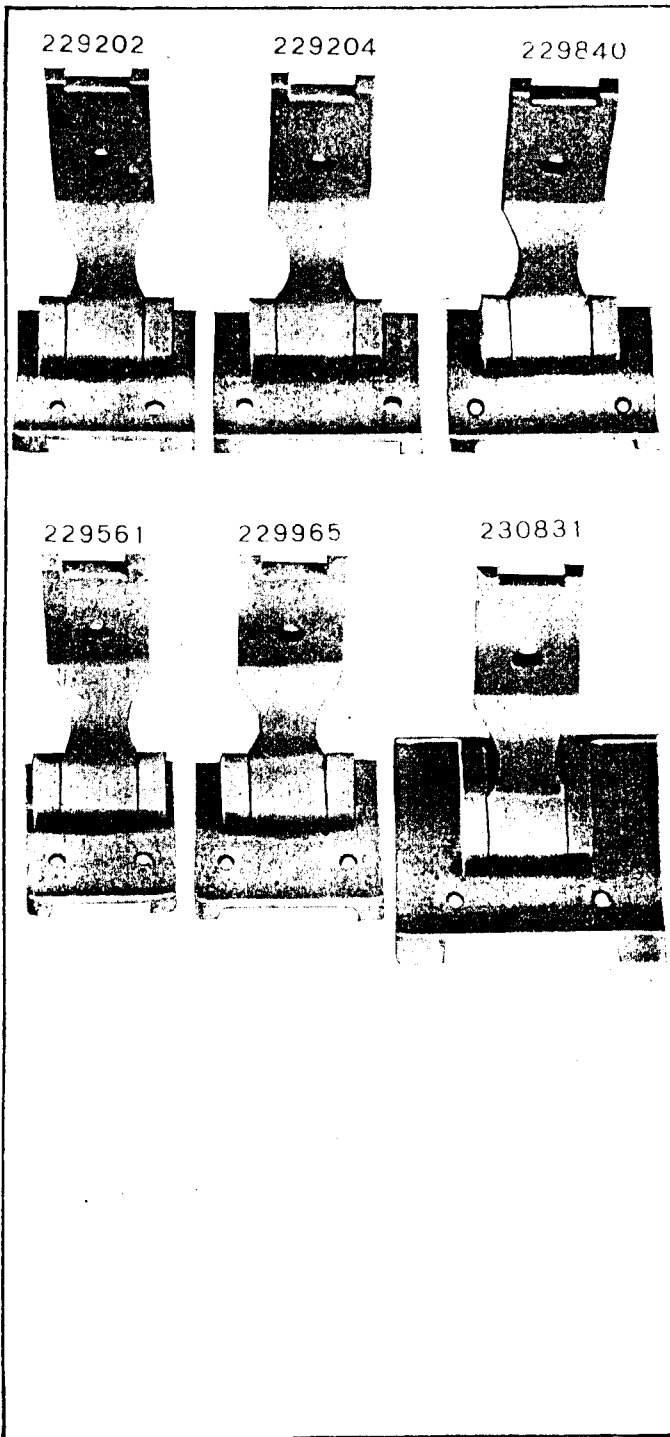


PLATE 12085-FULL SIZE

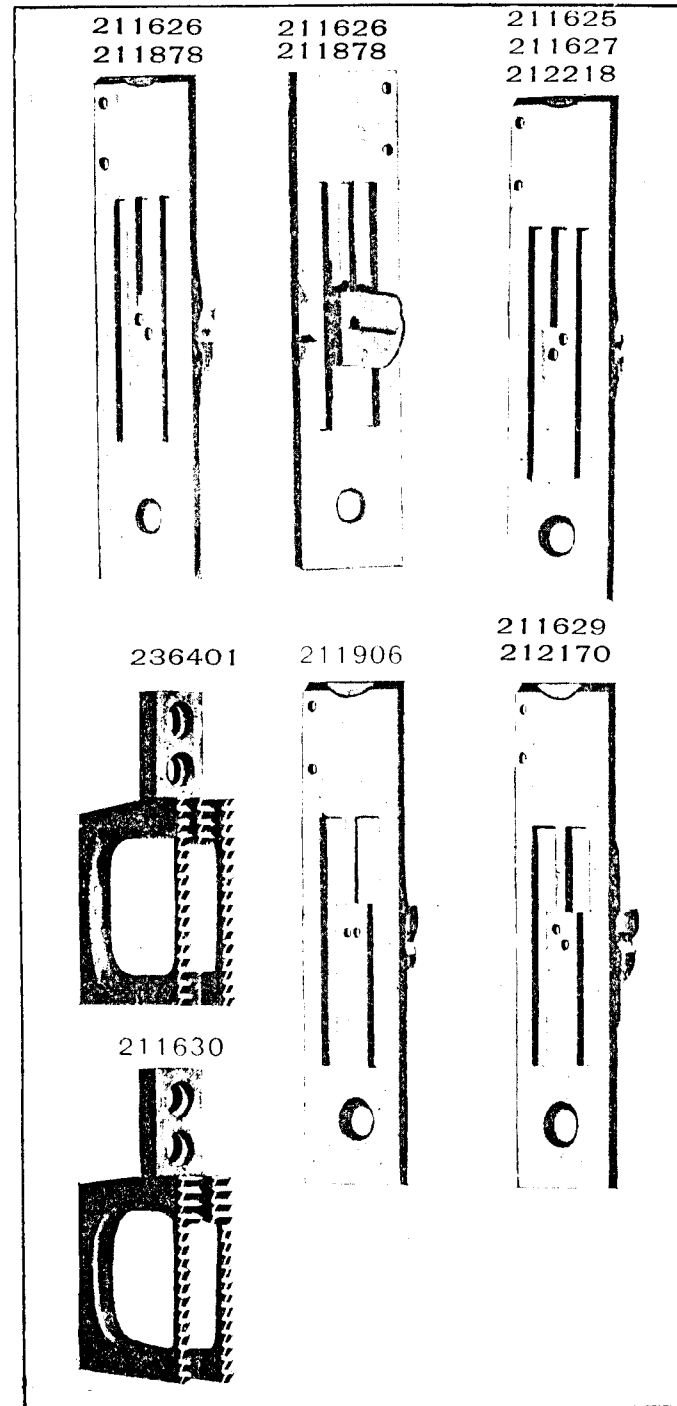


PLATE 12086—FULL SIZE

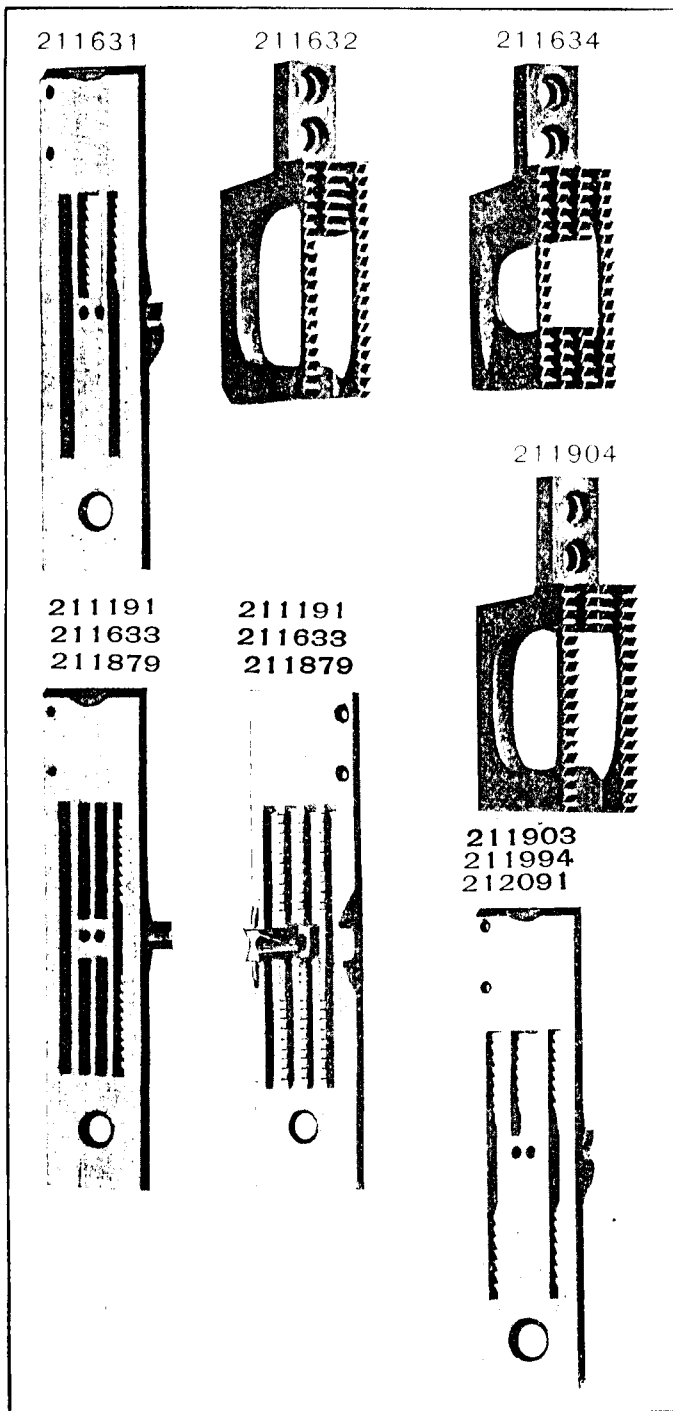


PLATE 12087—FULL SIZE

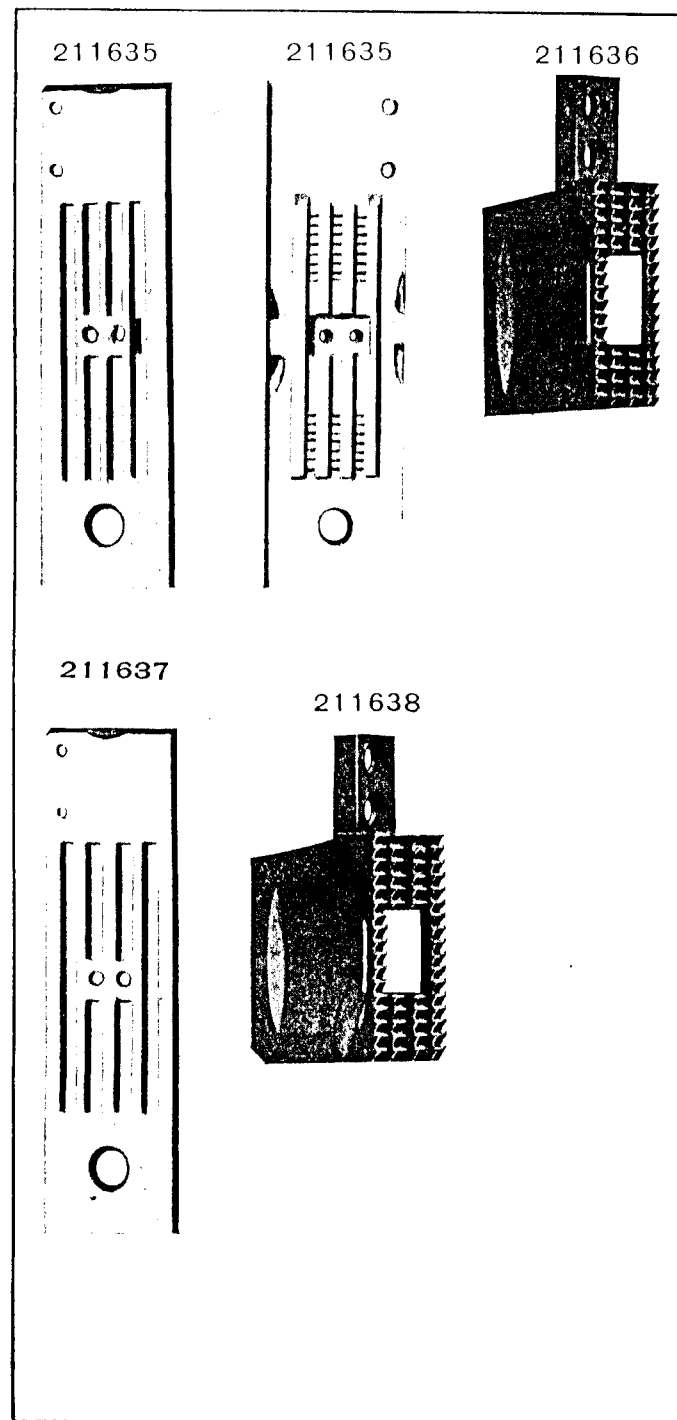


PLATE 12090—FULL SIZE

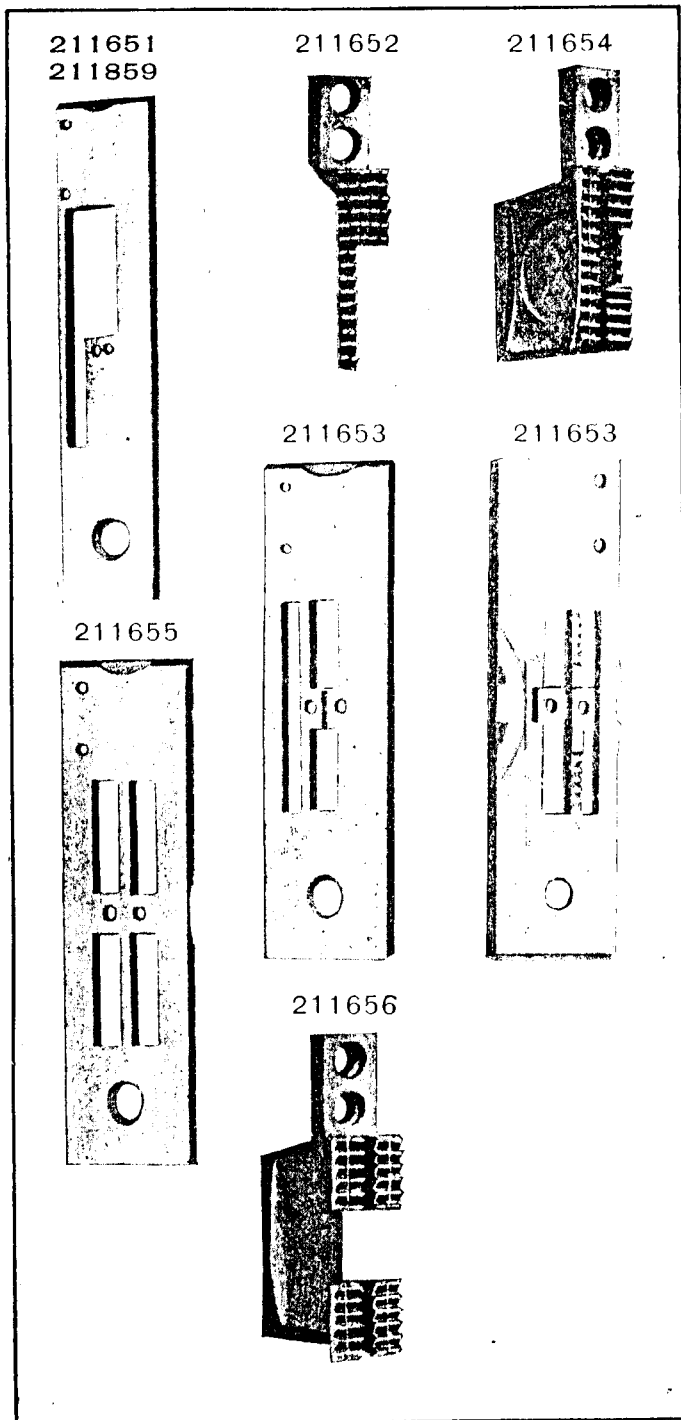


PLATE 12091—FULL SIZE

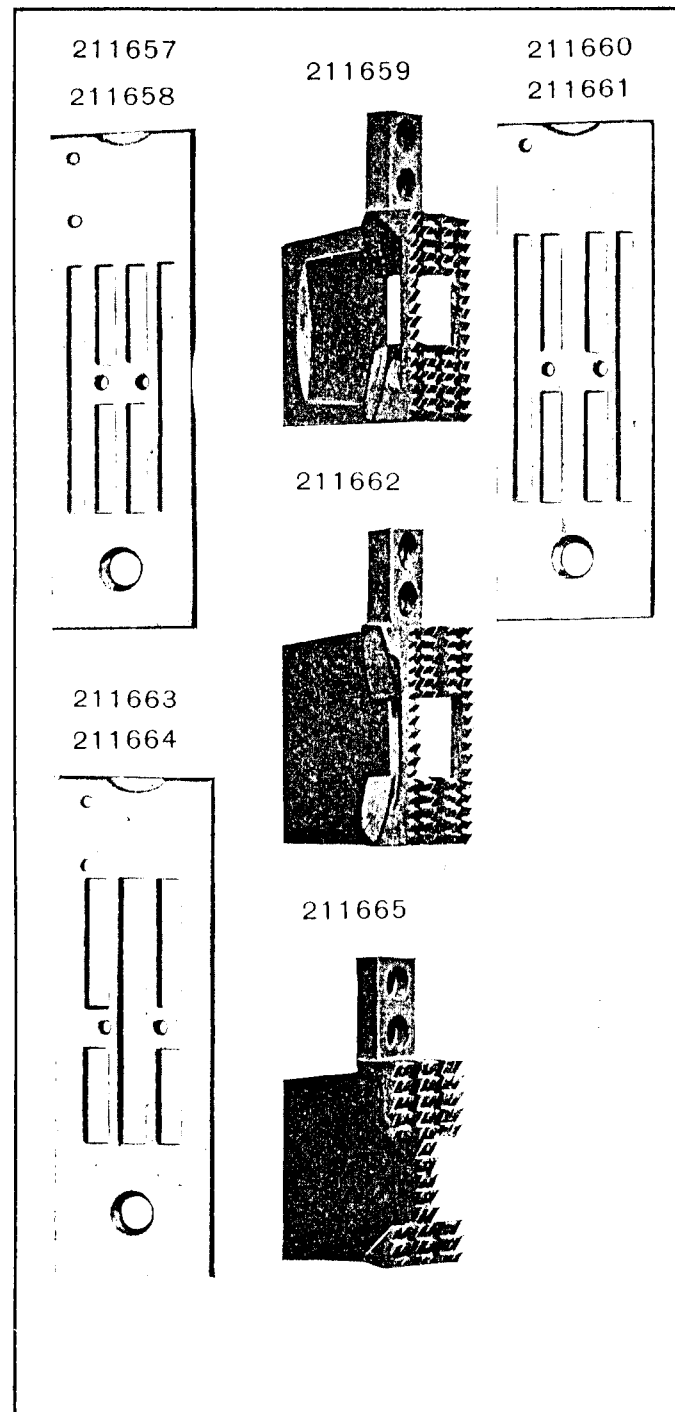
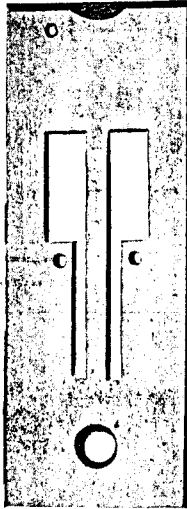


PLATE 12092-FULL SIZE

211666
211667
211668



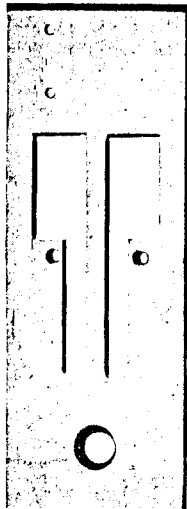
211669



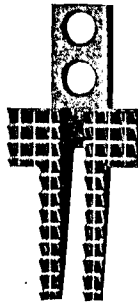
211670



211671
211672
211673



211674

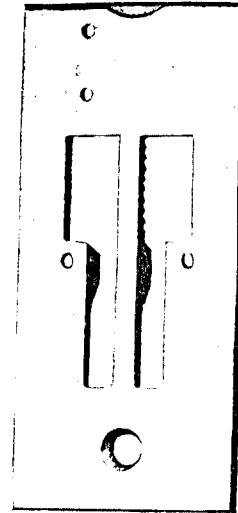


211675



PLATE 12093-FULL SIZE

211676
211677
211678



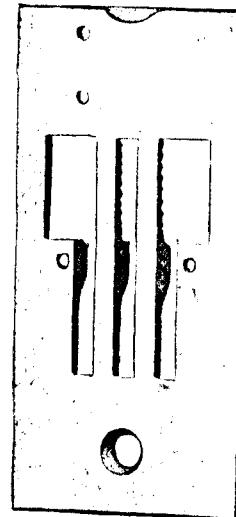
211679



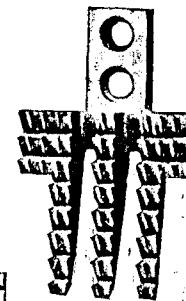
211680



211681
211682
211683



211684



211685

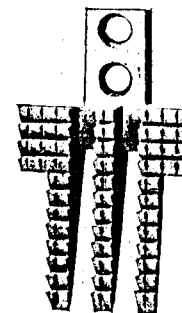
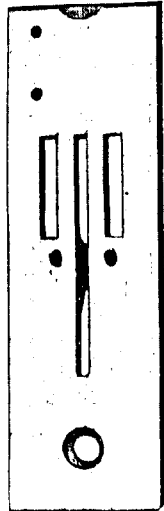
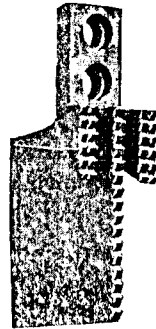


PLATE 12099-FULL SIZE

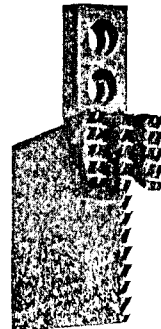
211715
211716



211717



211718



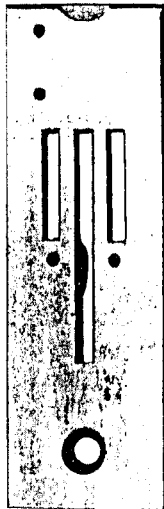
211721



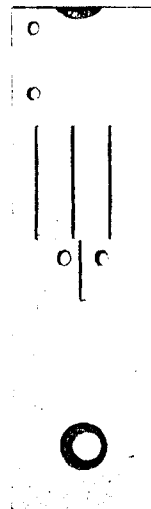
211722



211719
211720



203769
211713



211714

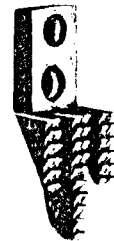
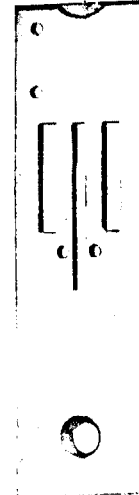


PLATE 12100-FULL SIZE

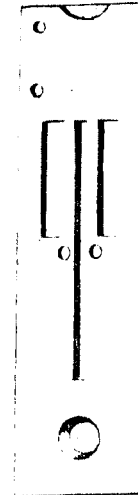
211723
211724



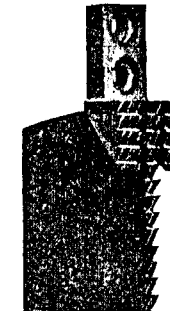
211725



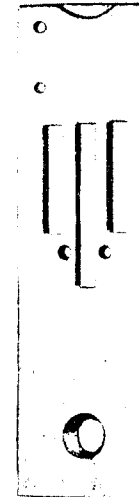
211726
211727



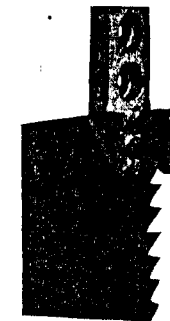
211728



211018
211731



211729



211732



211733



PLATE 12103-FULL SIZE

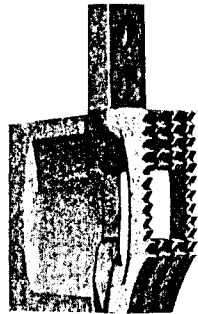
211755



211756



211758



211762



211757



211761



211759
211760

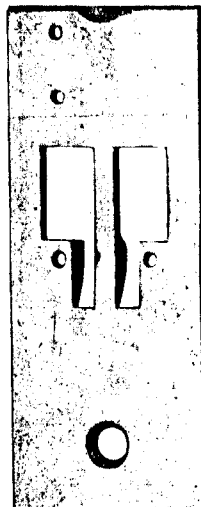
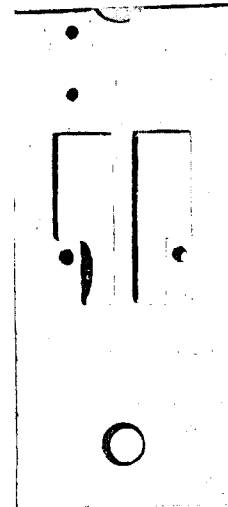
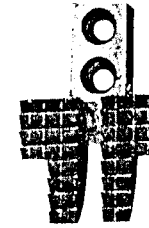


PLATE 12104-FULL SIZE

211763
211764



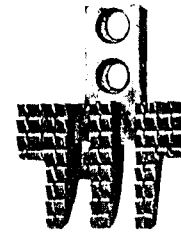
211765



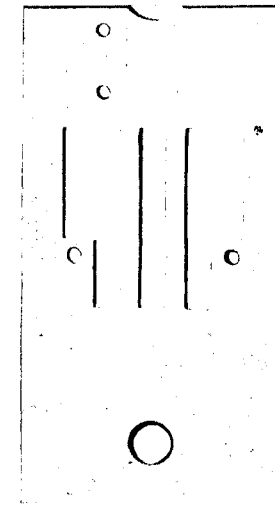
211766



211769



211767
211768



211770



PLATE 12106-FULL SIZE

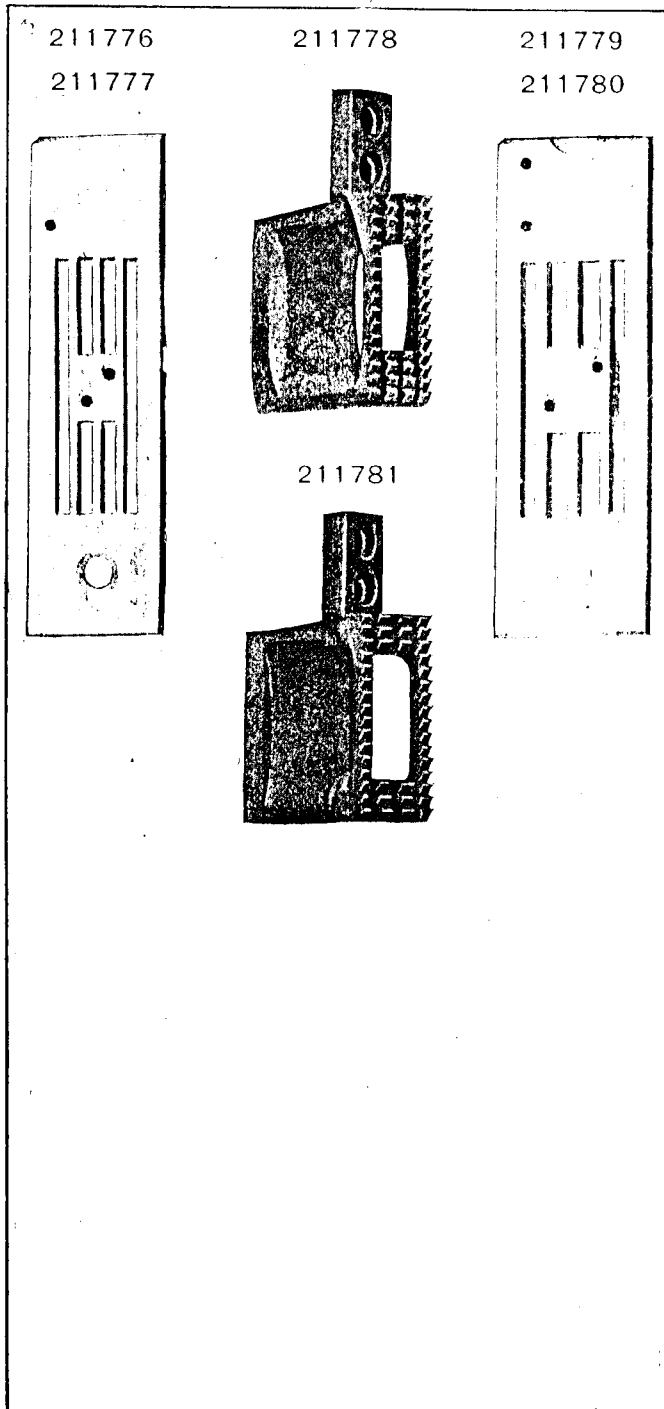


PLATE 12111-FULL SIZE

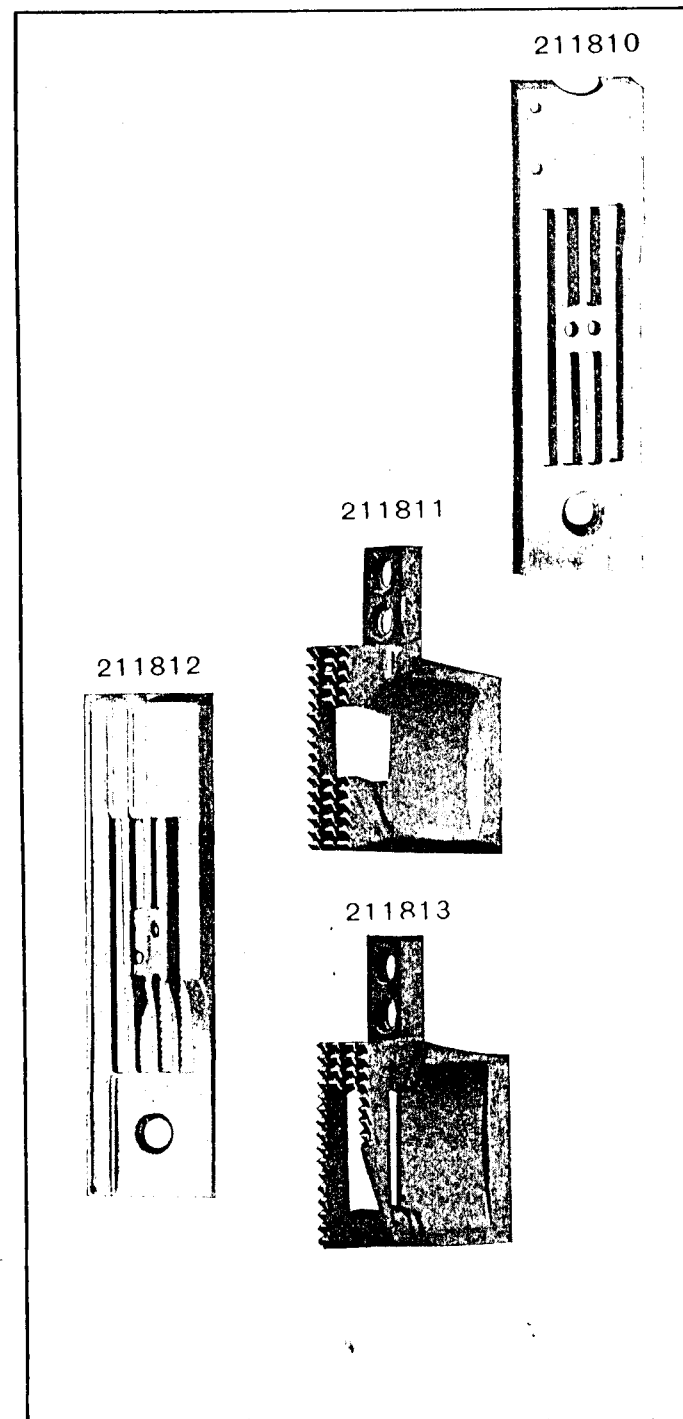


PLATE 12112-FULL SIZE

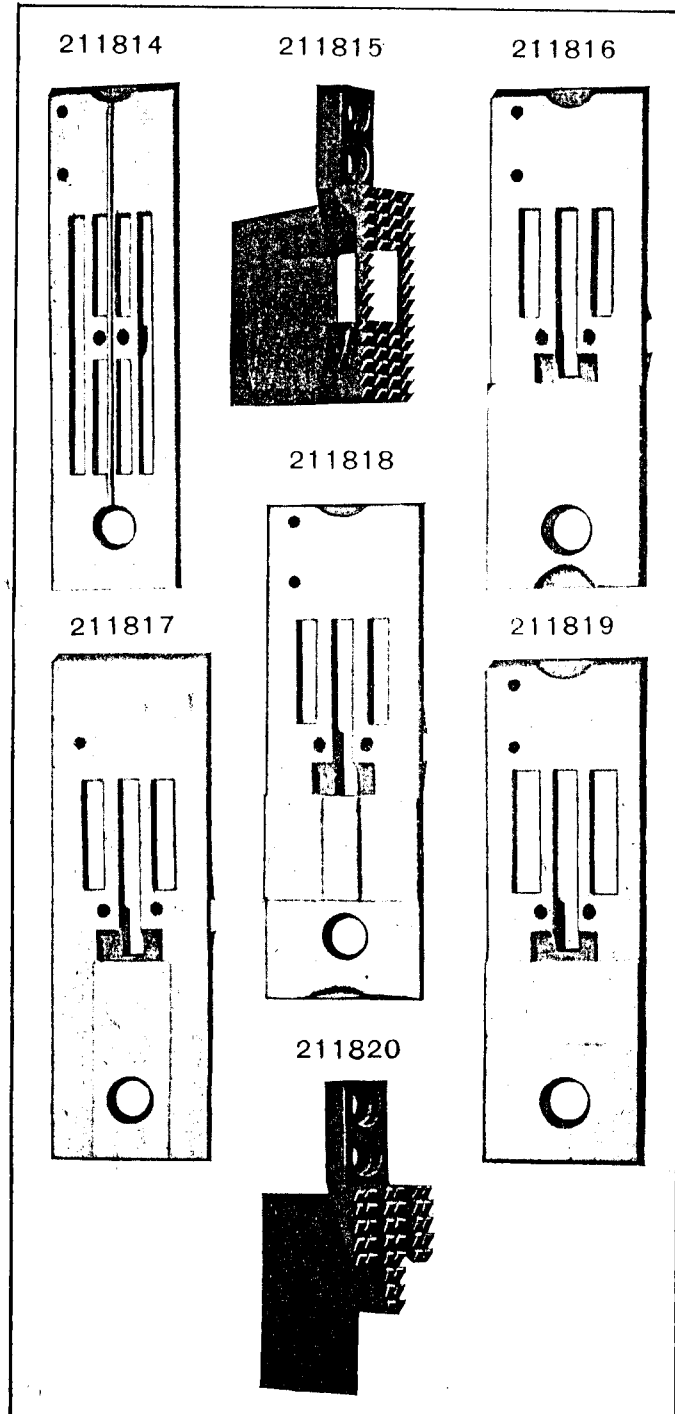


PLATE 12113-FULL SIZE

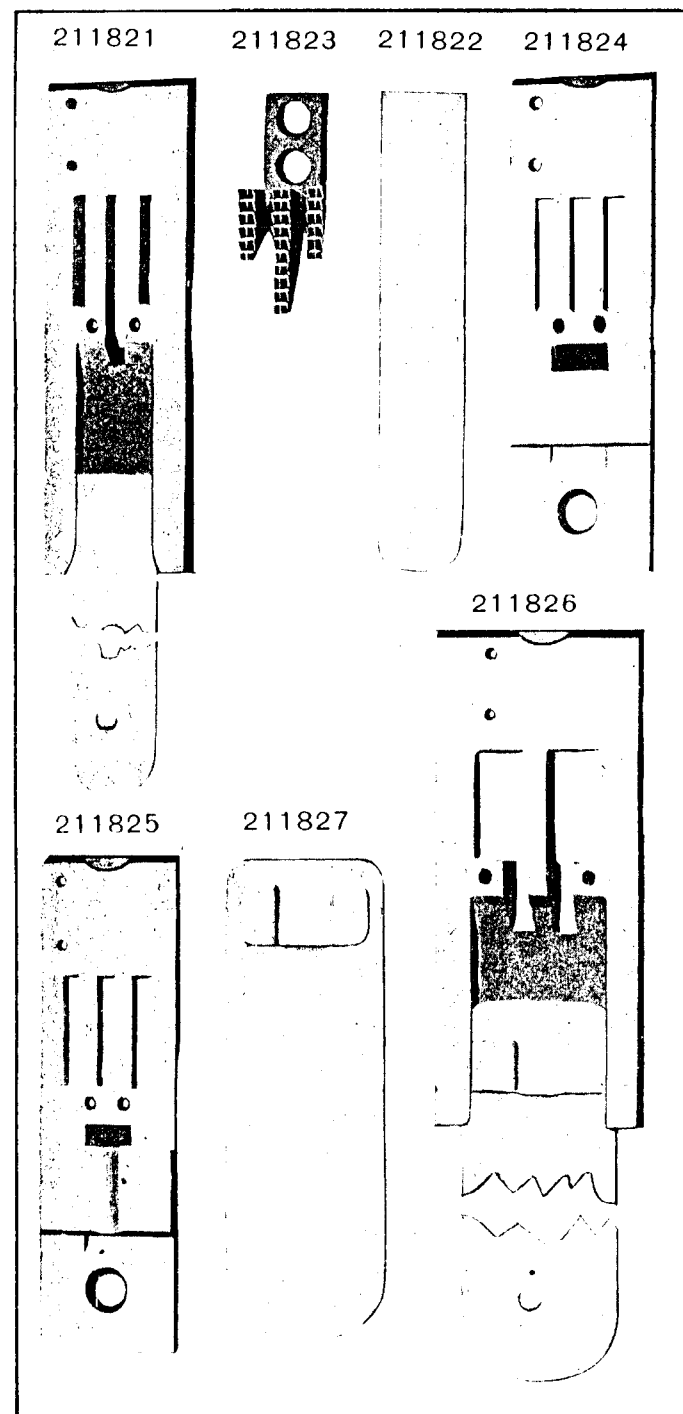


PLATE 12114-FULL SIZE

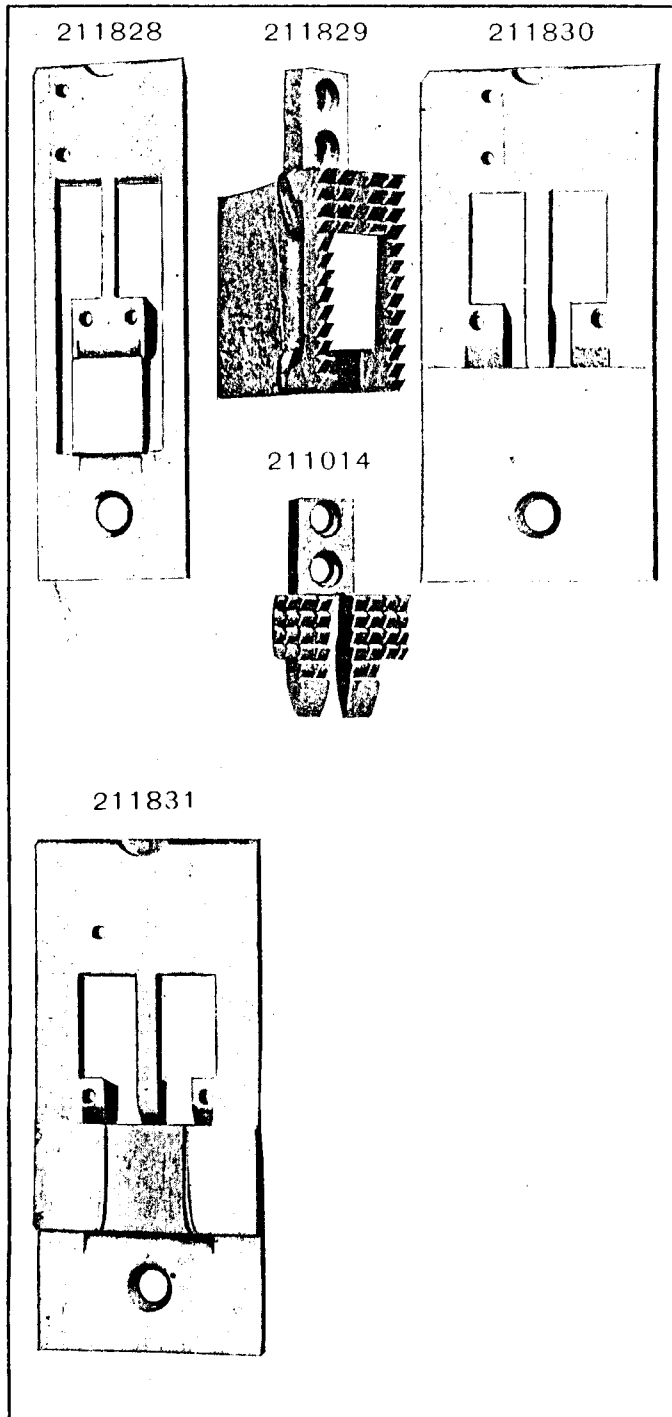


PLATE 12115-FULL SIZE

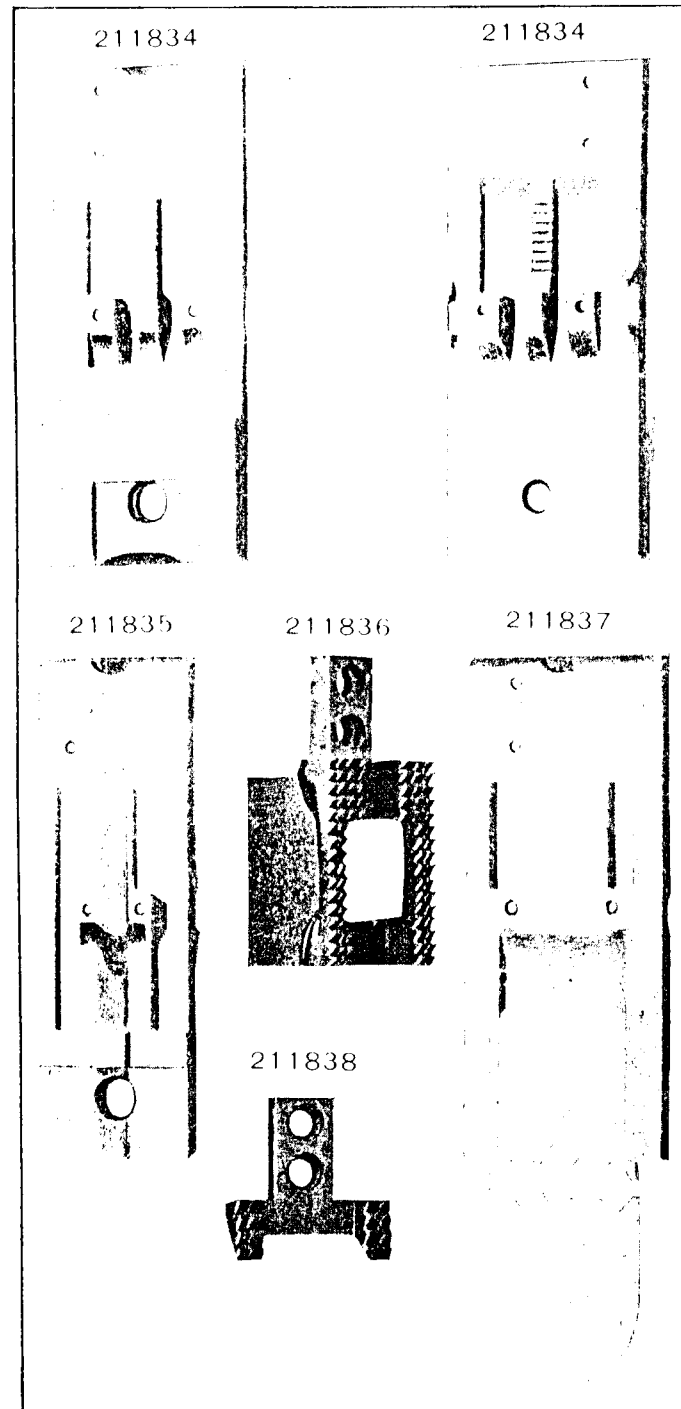


PLATE 12116—FULL SIZE

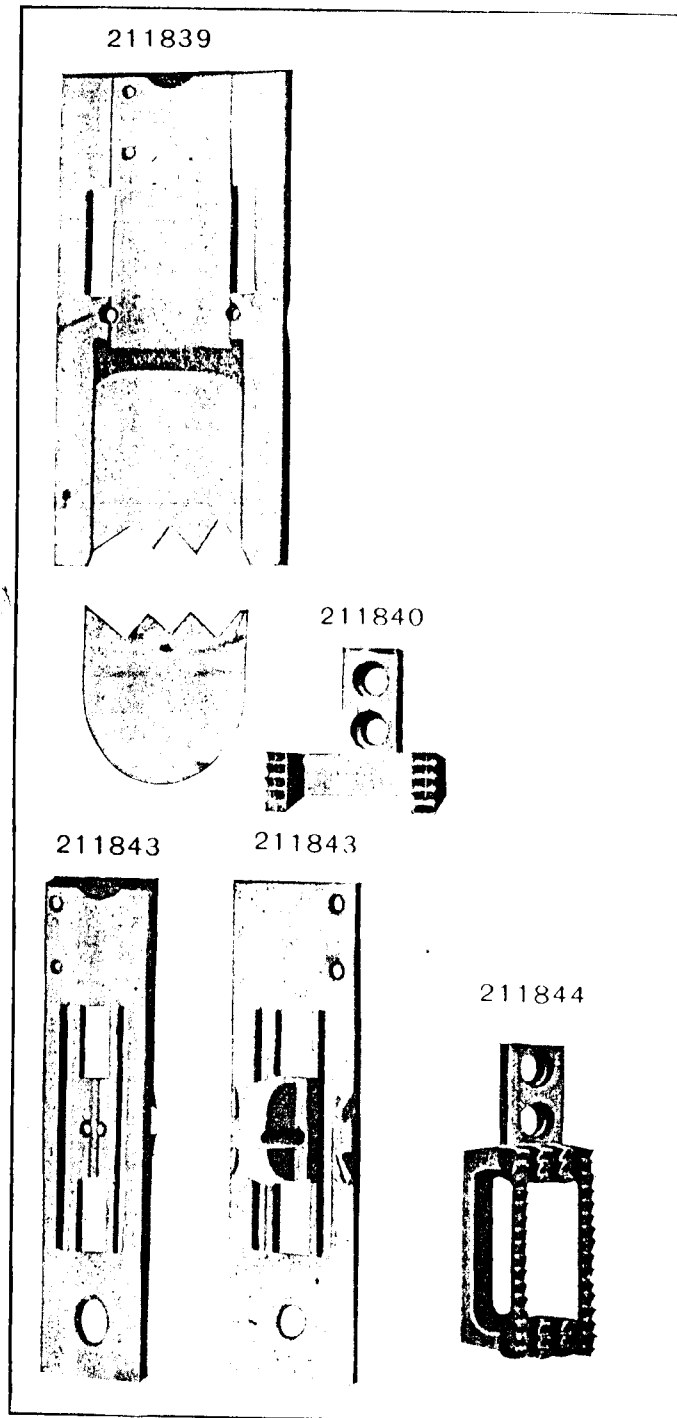


PLATE 12117—FULL SIZE

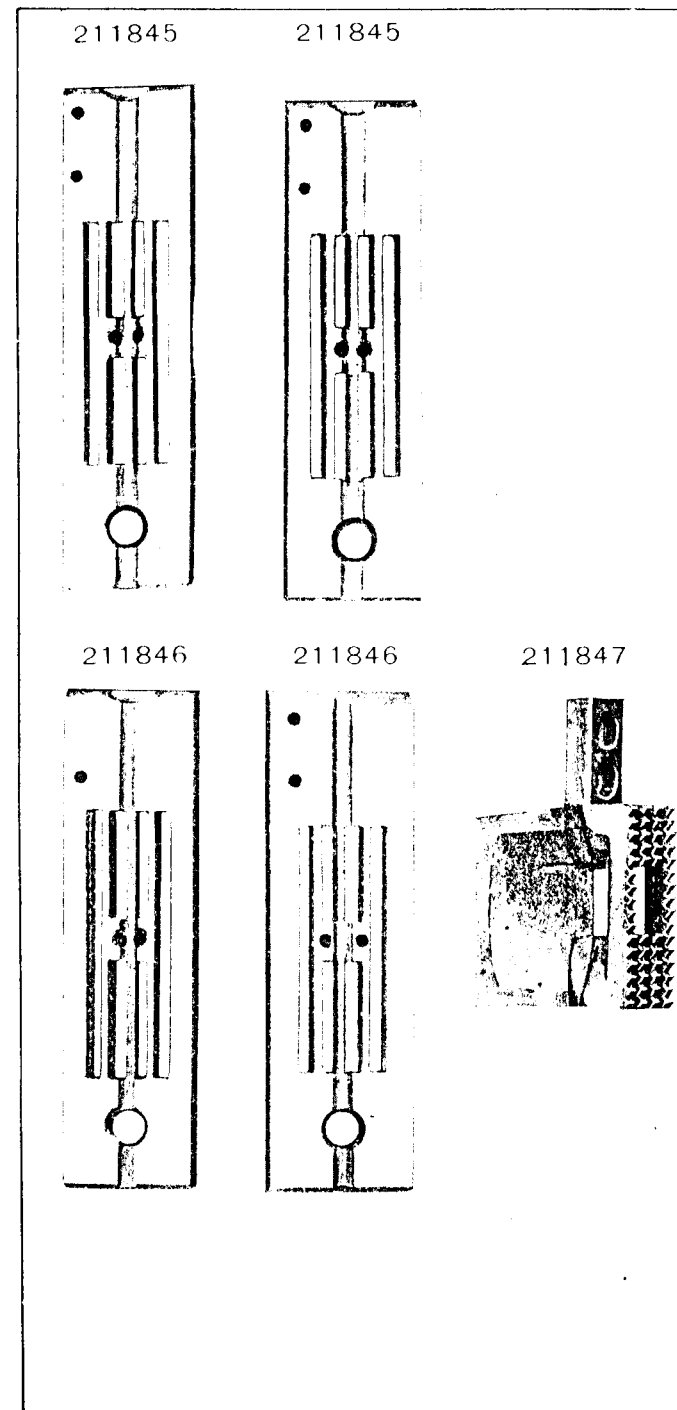
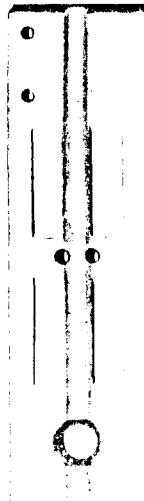


PLATE 12118-FULL SIZE

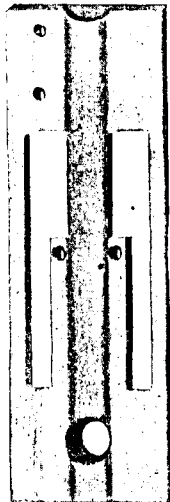
211848



211848



211849



211849

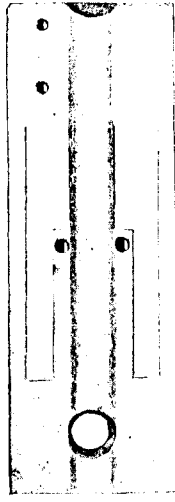
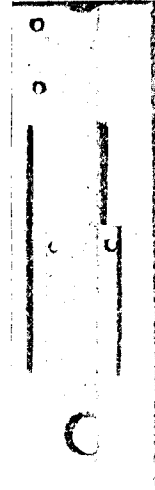
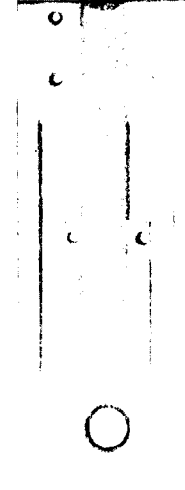


PLATE 12119-FULL SIZE

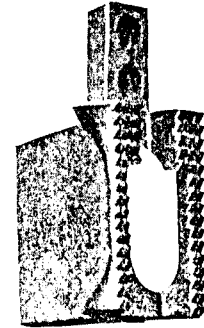
211850



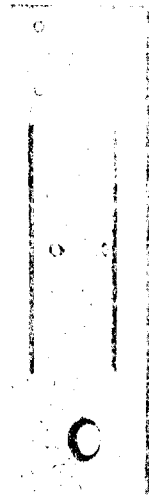
211850



211851



211852



211853

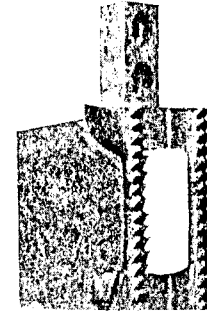
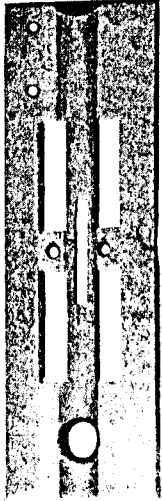
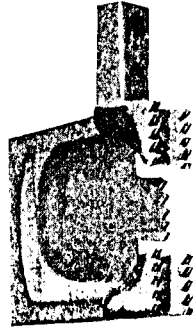


PLATE 12120—FULL SIZE

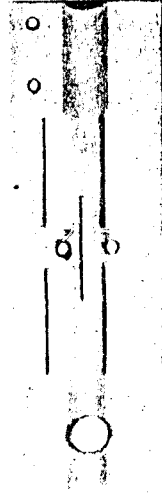
211854



211855



211854



211856



211857

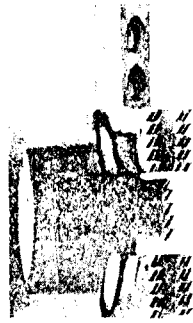
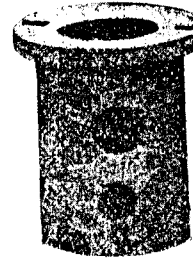


PLATE 12305—FULL SIZE

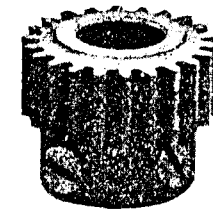
203249



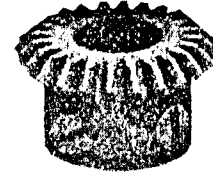
200491



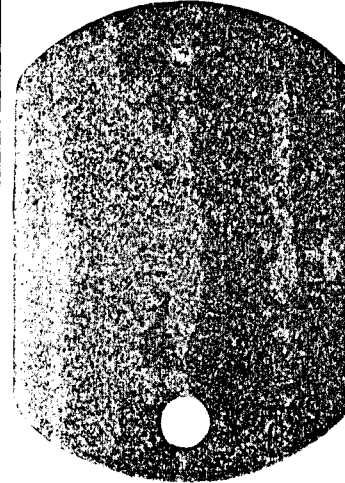
203246



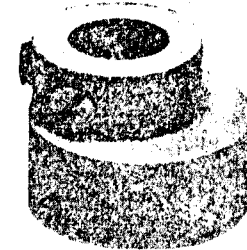
203242



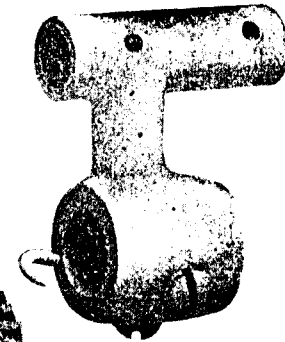
204163



203233



204200



213154

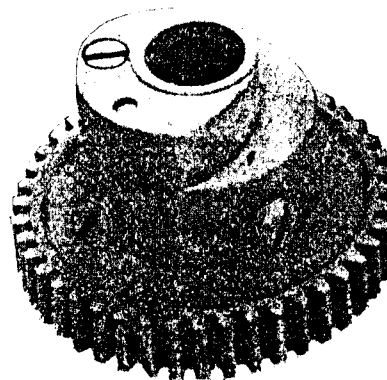


PLATE 12306—FULL SIZE

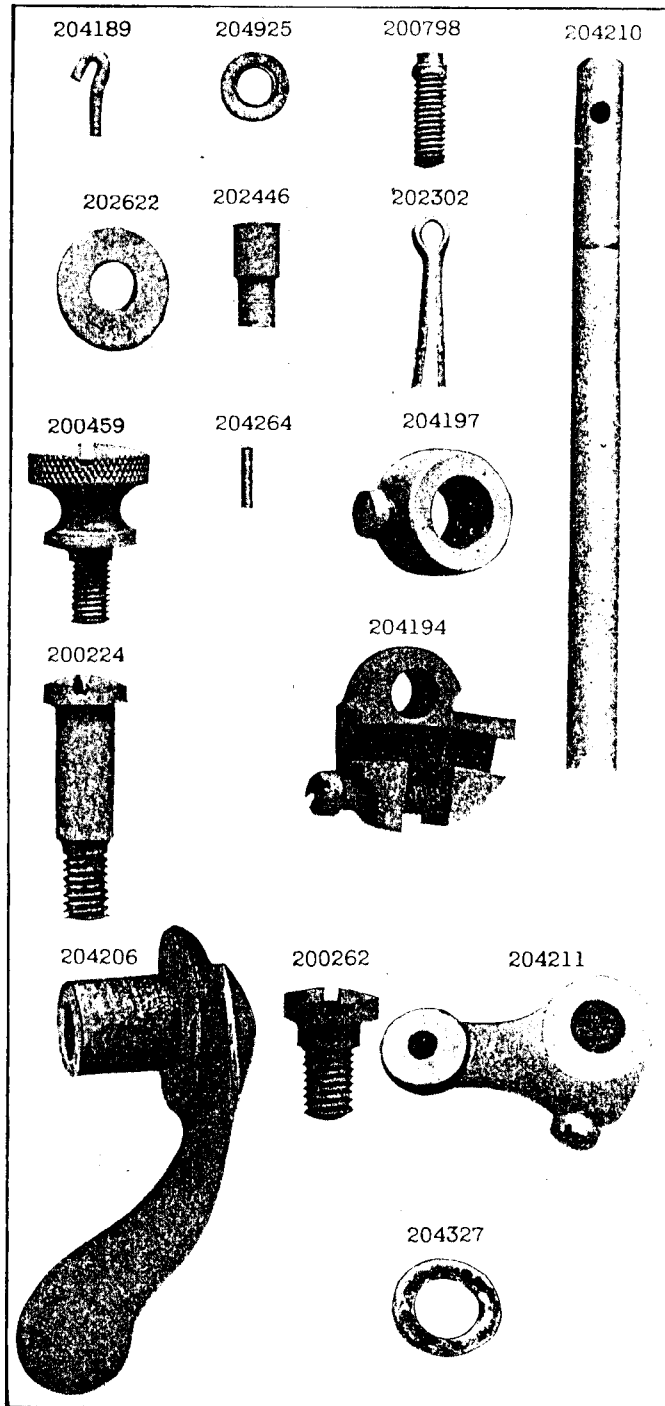


PLATE 12307—FULL SIZE

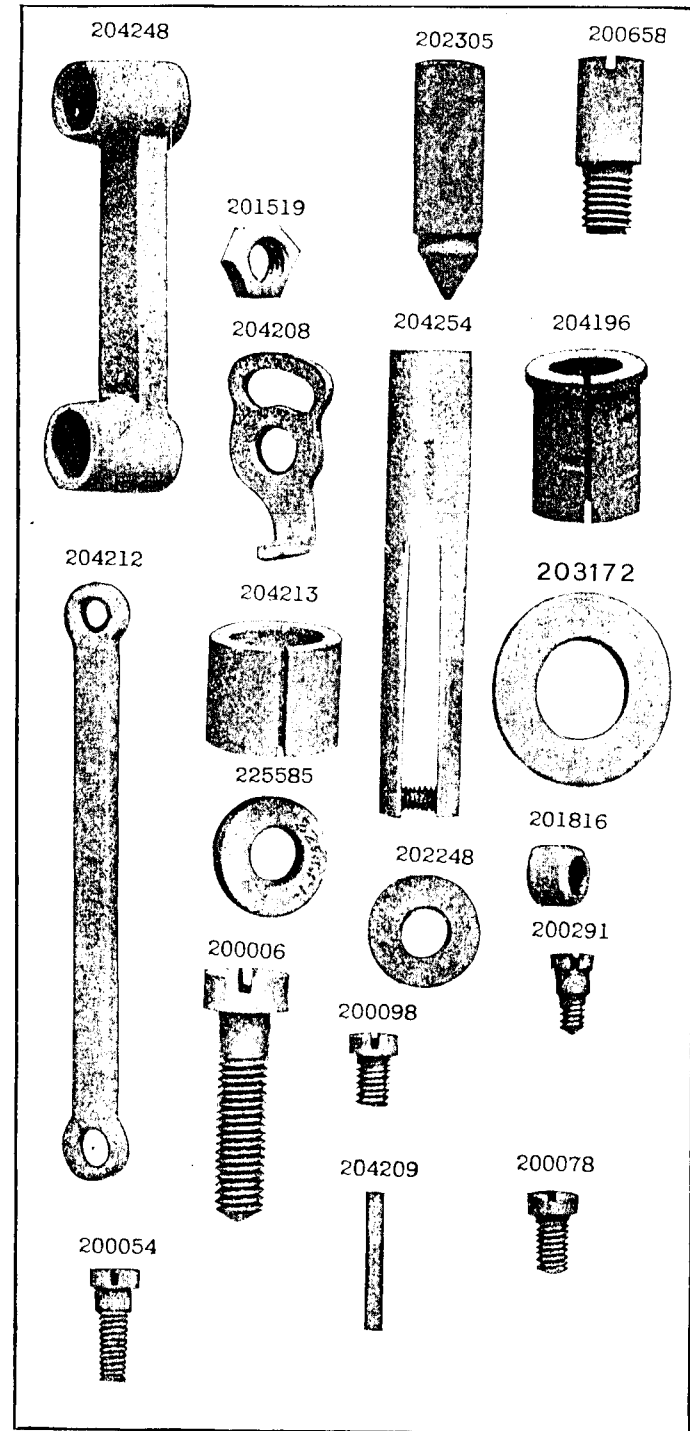


PLATE 12308—FULL SIZE

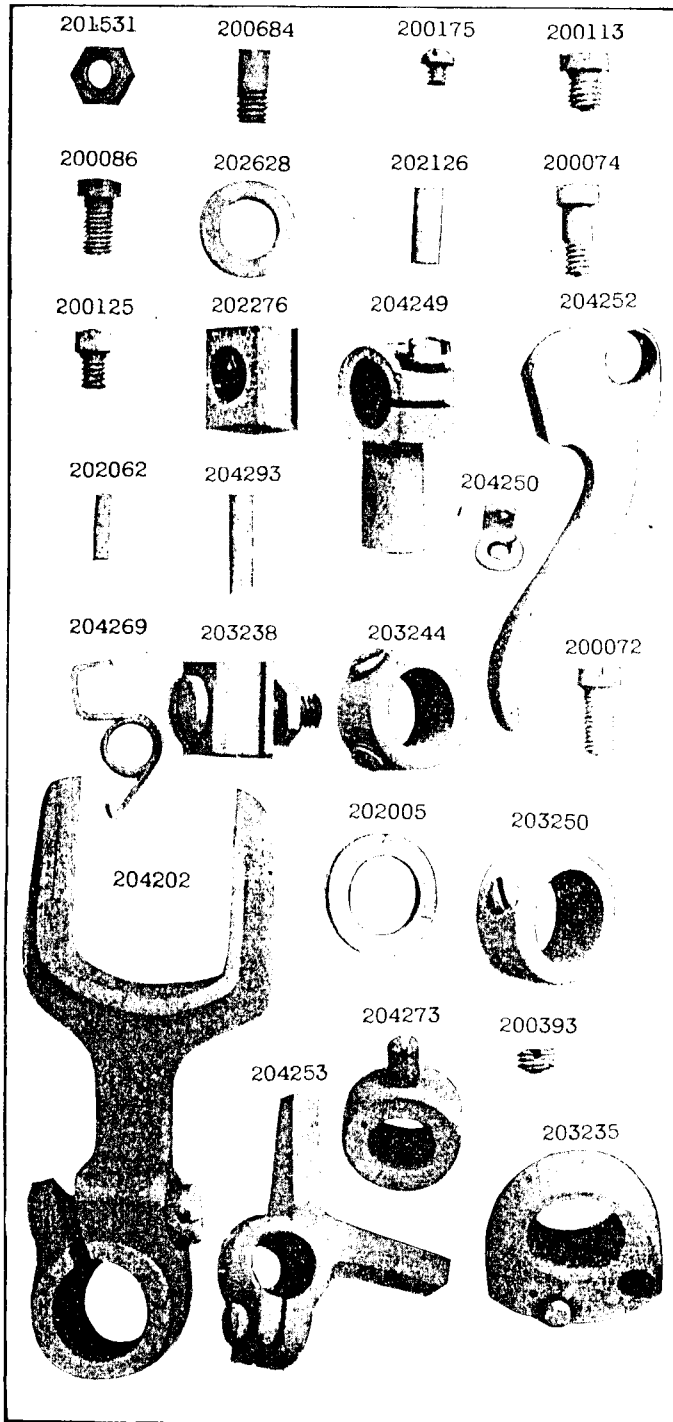


PLATE 12309—FULL SIZE

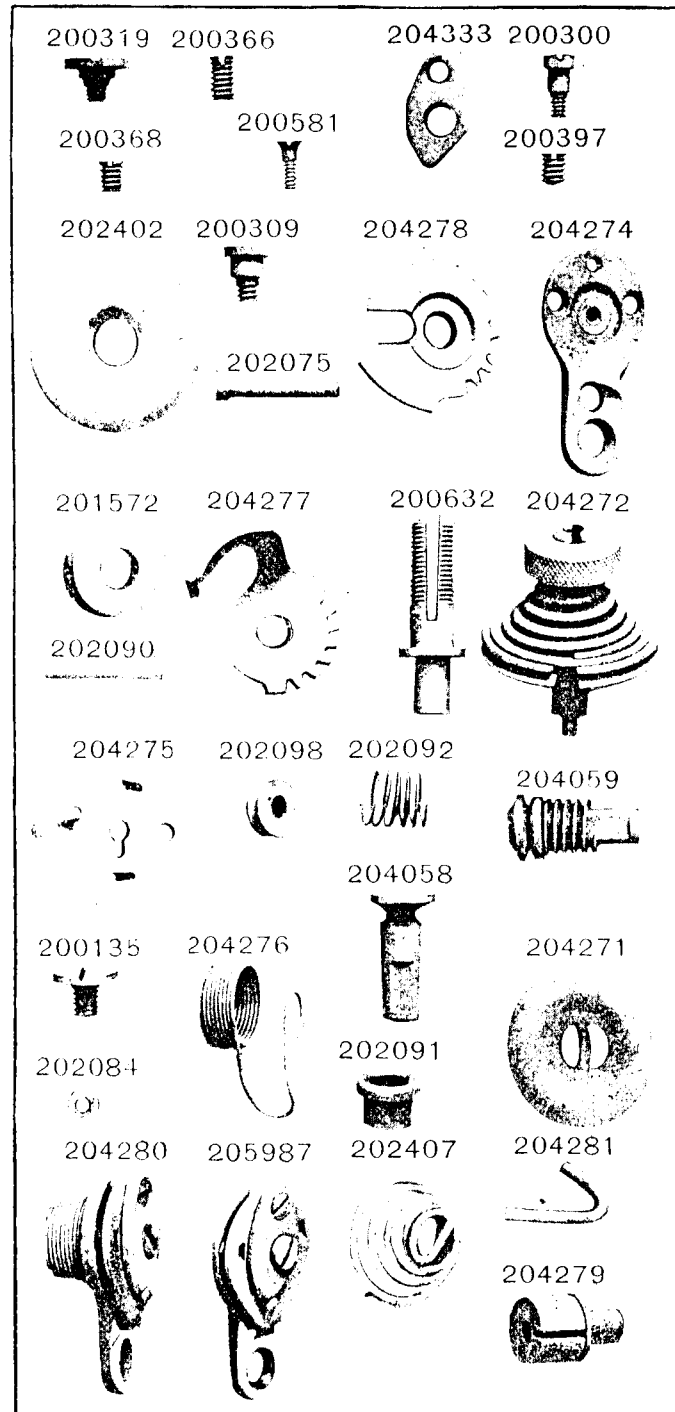


PLATE 12311-FULL SIZE

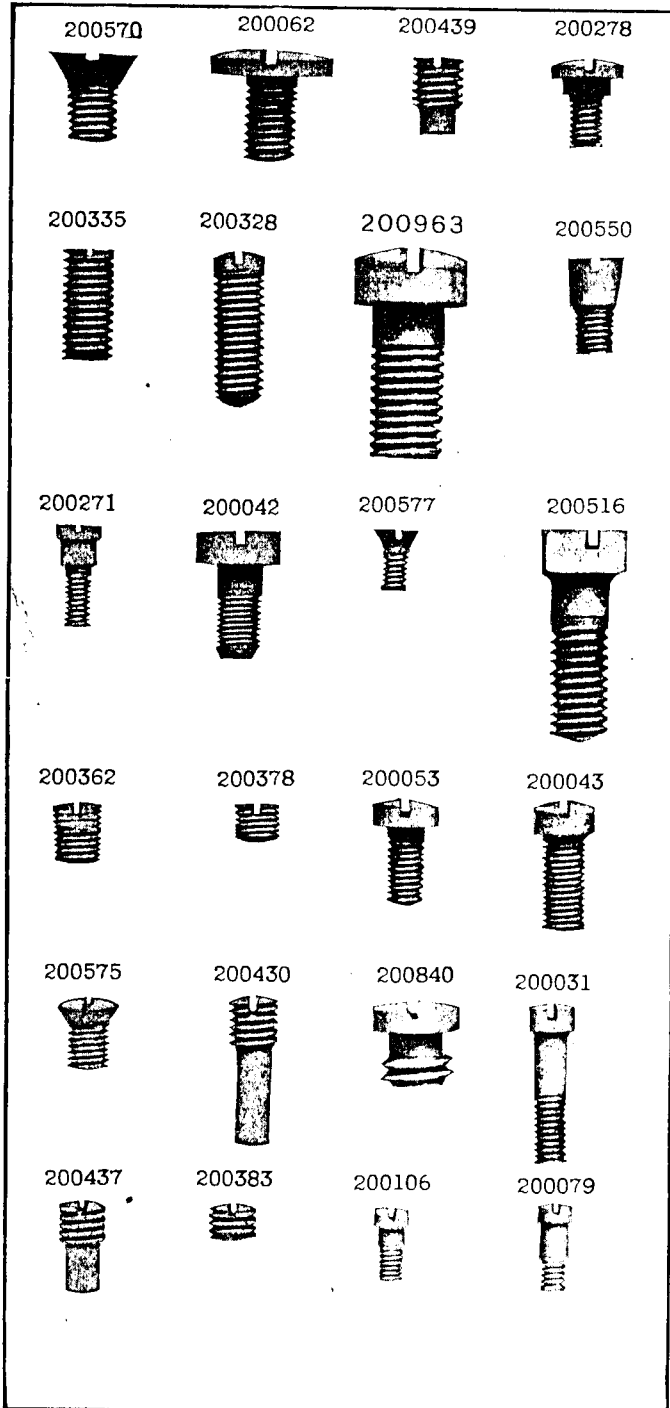


PLATE 12312-FULL SIZE

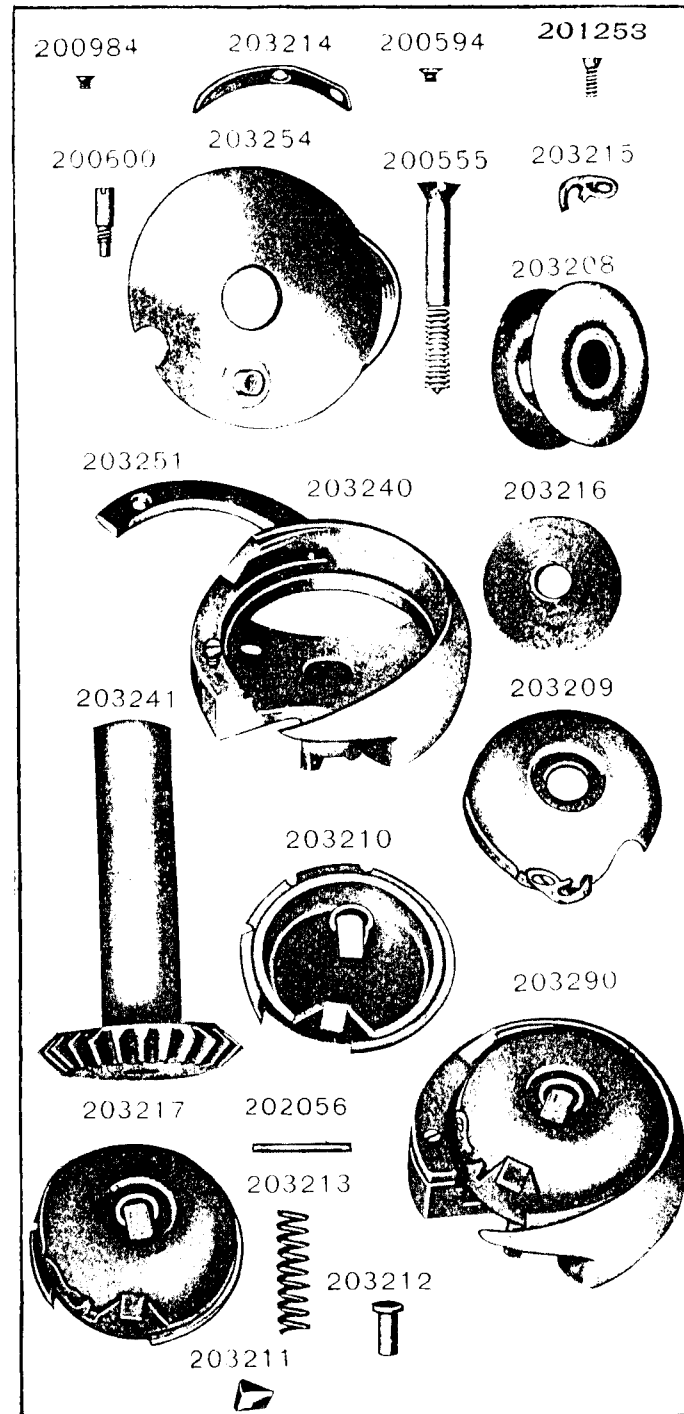


PLATE 12319 - FULL SIZE

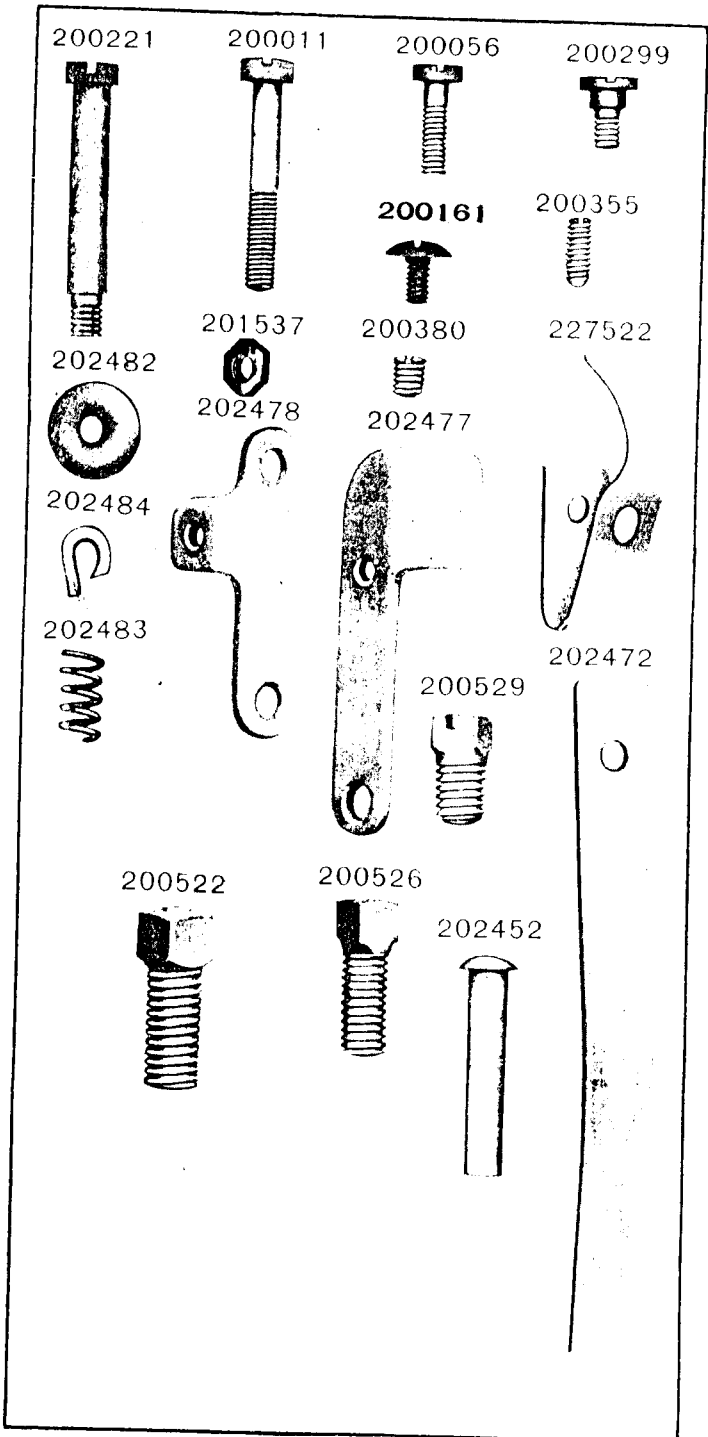


PLATE 12320 - ONE-HALF SIZE

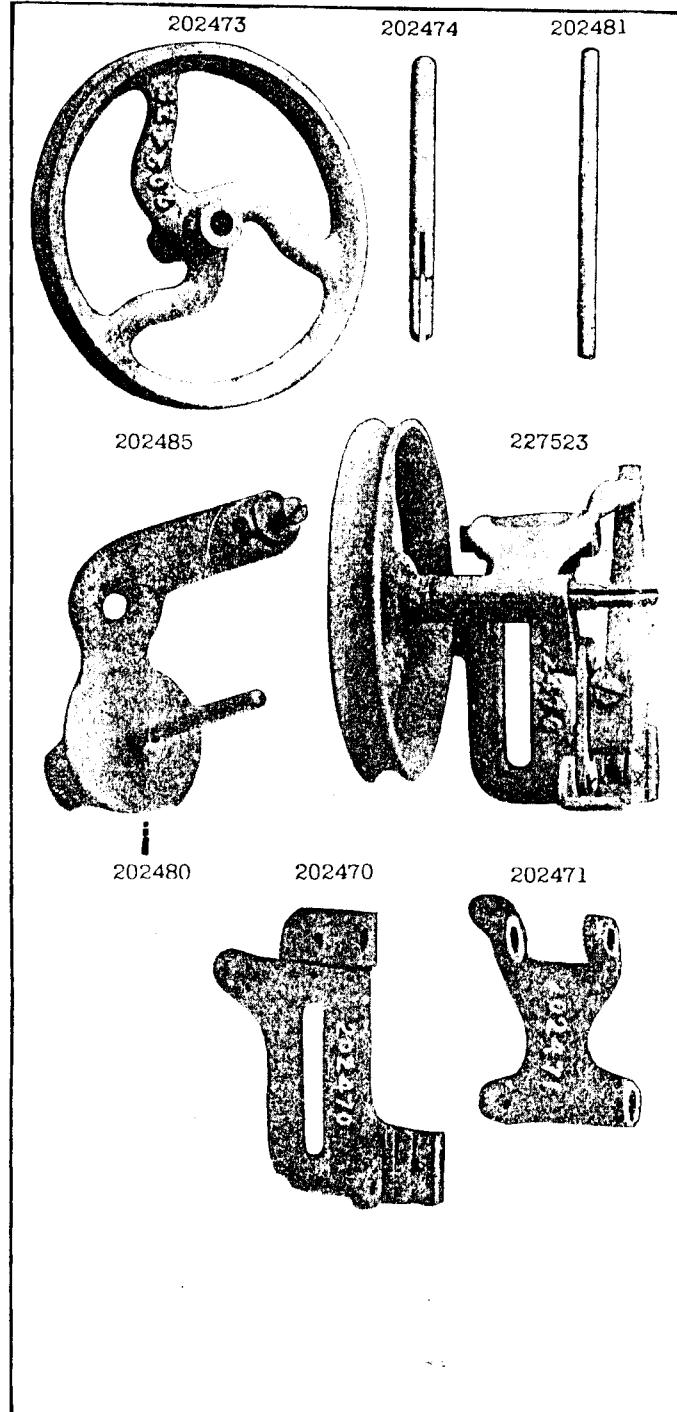


PLATE 12331—FULL SIZE

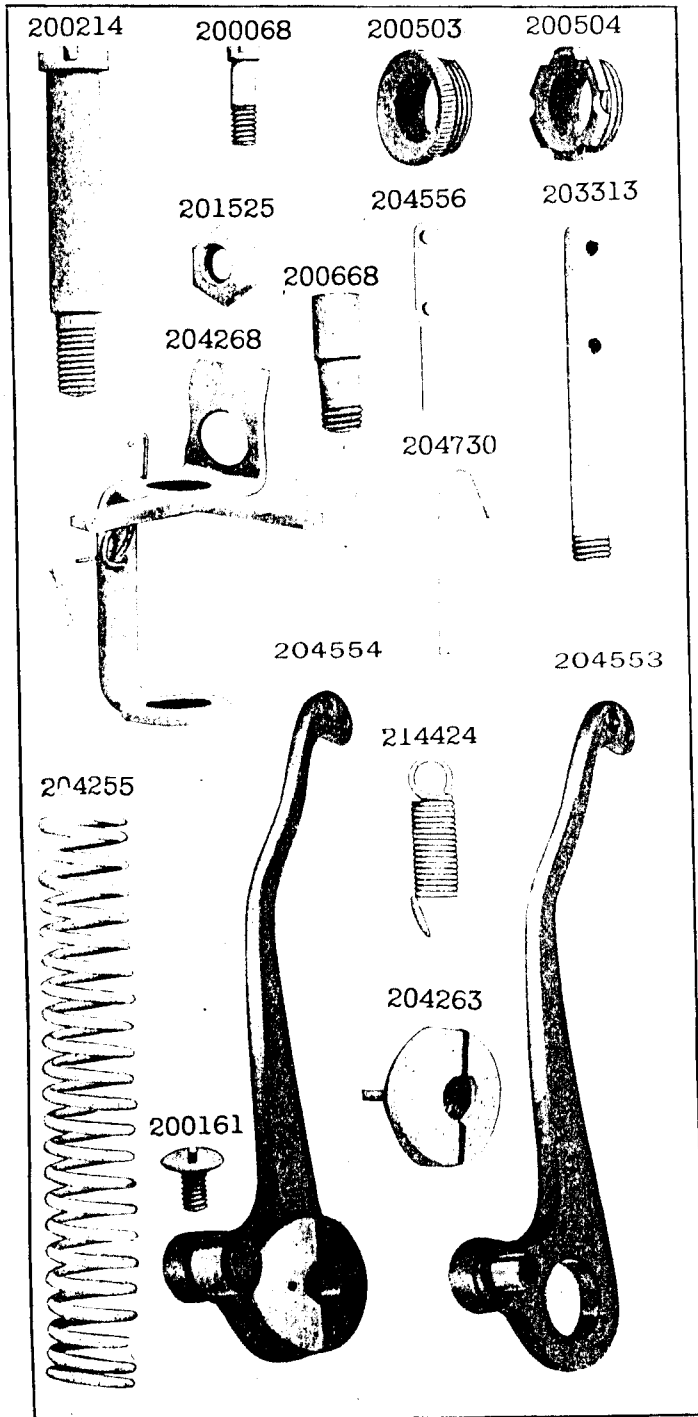


PLATE 12332—FULL SIZE

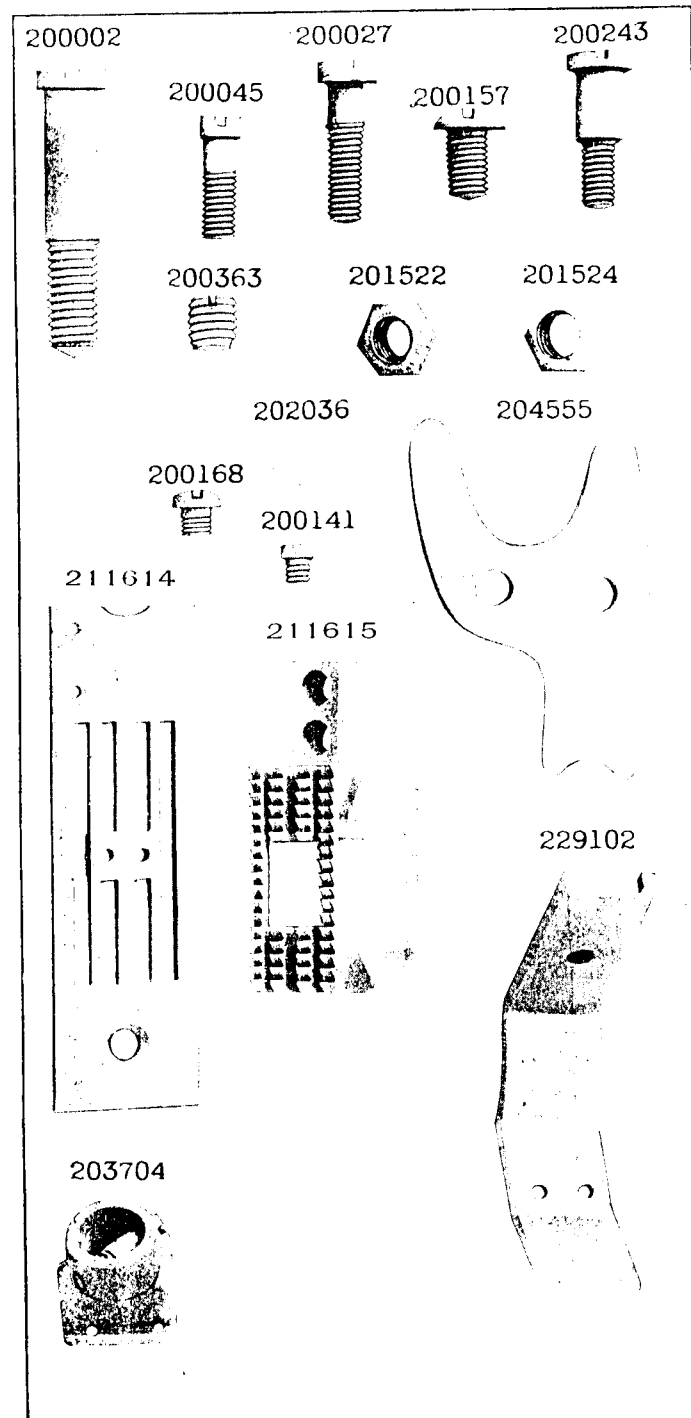


PLATE 12333—ONE-FOURTH SIZE

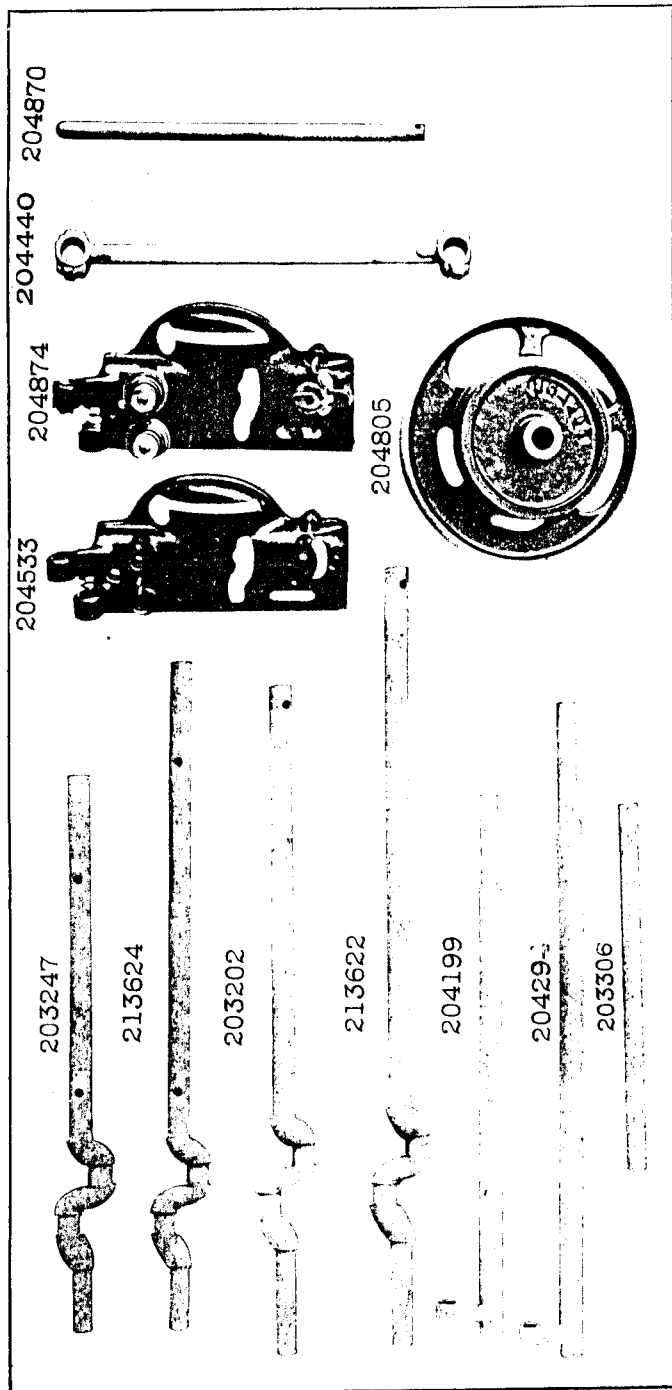


PLATE 12334—ONE-HALF SIZE

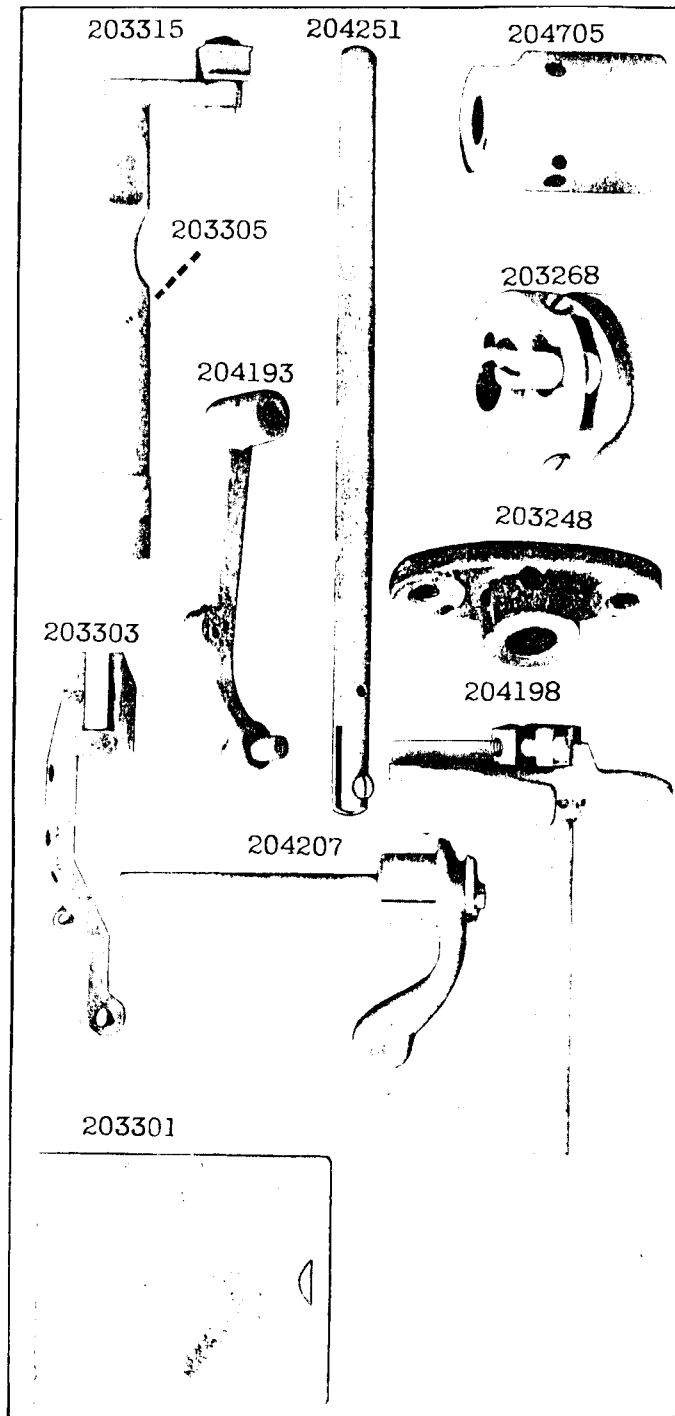
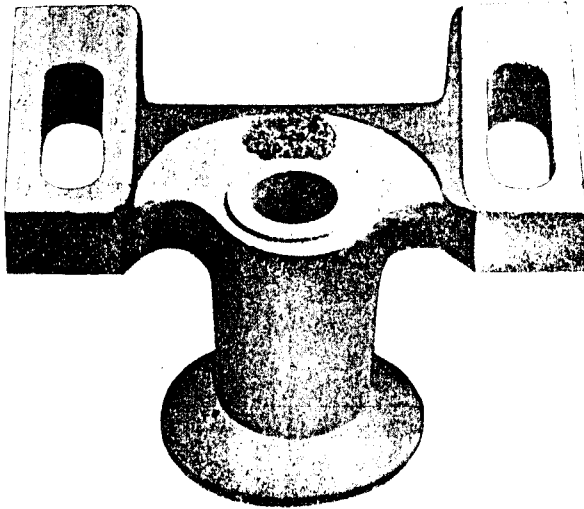


PLATE 12335—FULL SIZE

203307



203308

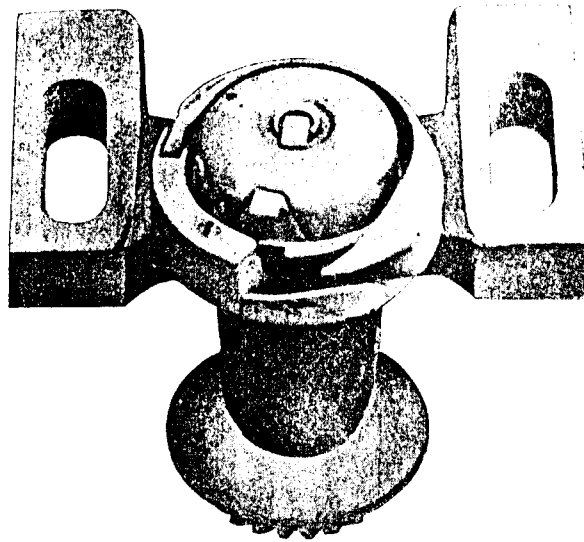


PLATE 12345—ONE-HALF SIZE

41400



225497



225498



202258



36578

225554



36579

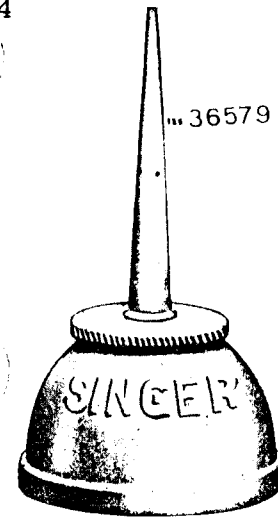


PLATE 13071-FULL SIZE

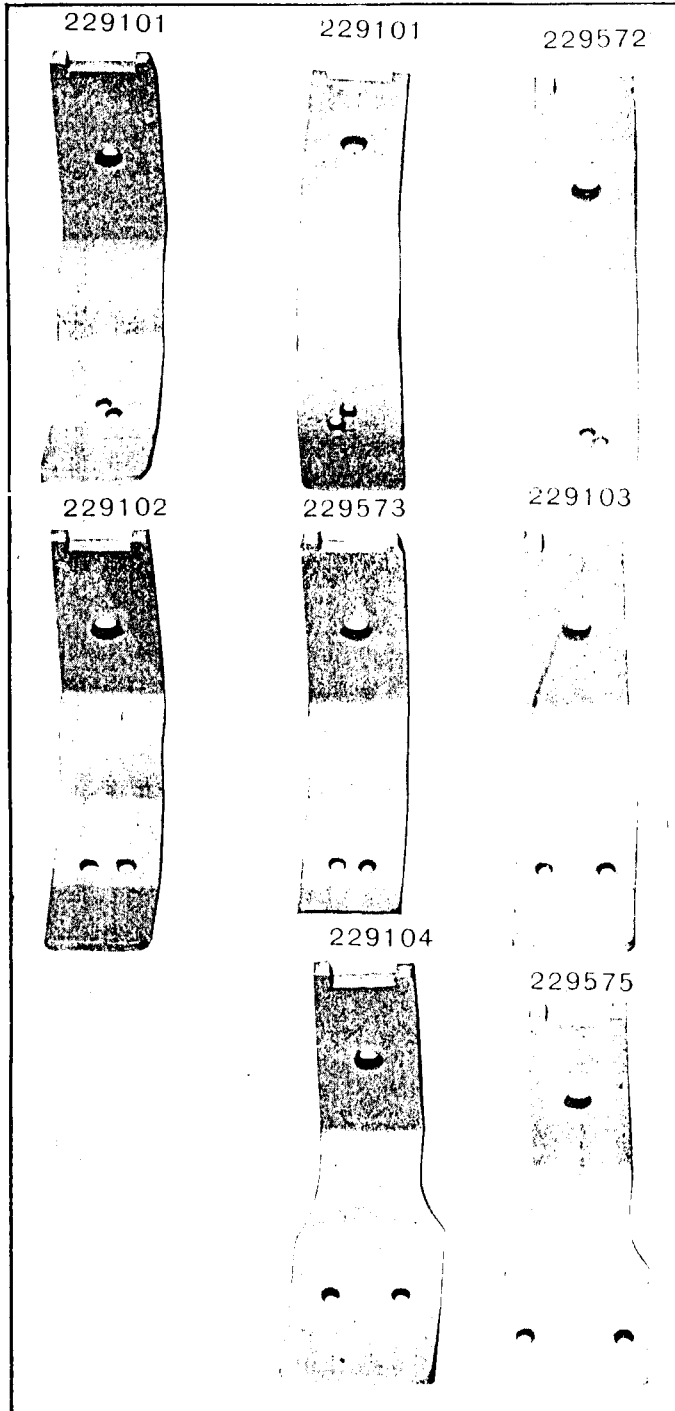


PLATE 13072-FULL SIZE

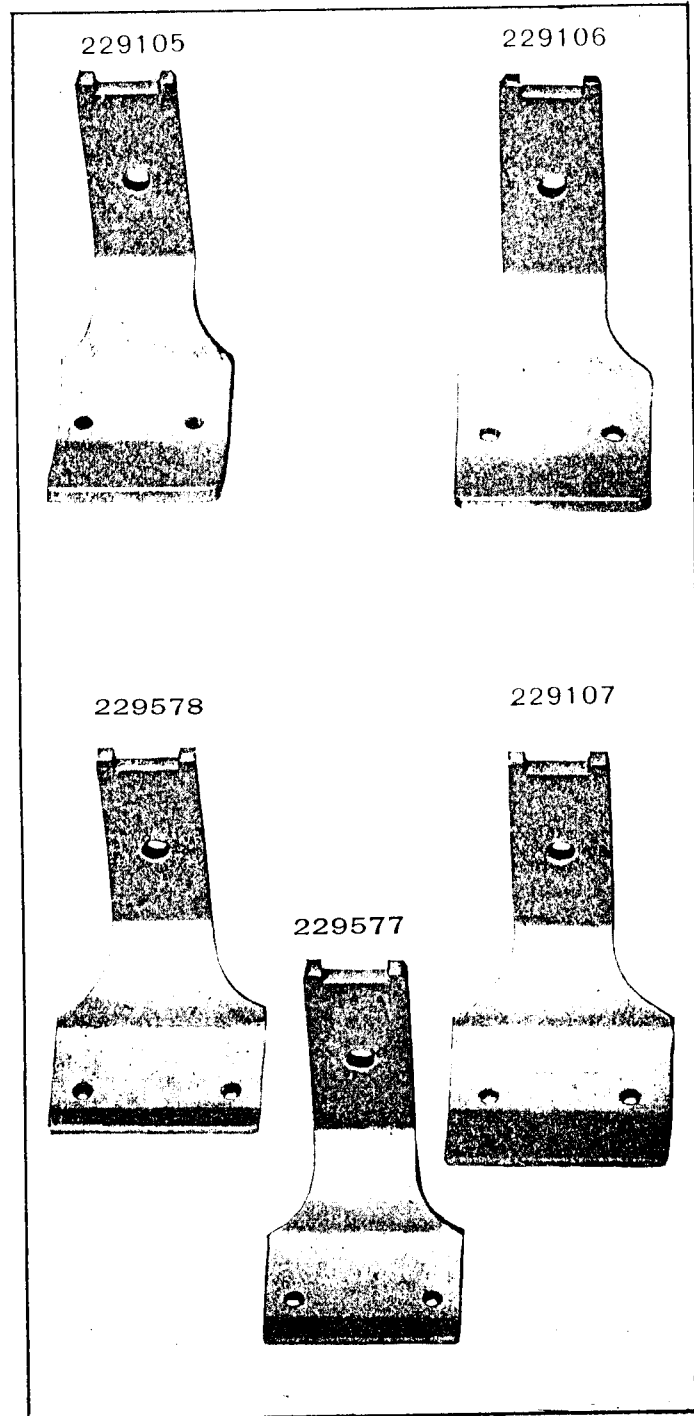
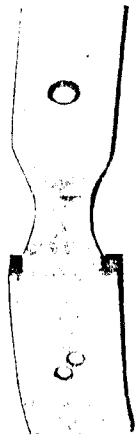


PLATE 13079—FULL SIZE

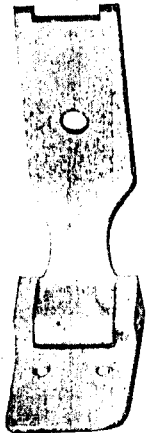
229129
229163



229129
229163



229133



229135

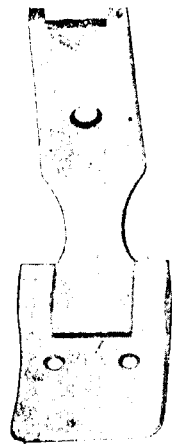


PLATE 13085—FULL SIZE

229192



229192



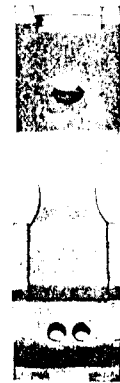
223901



229559



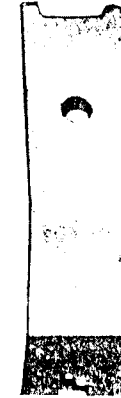
229194



229194



229559



229216



229008



229092

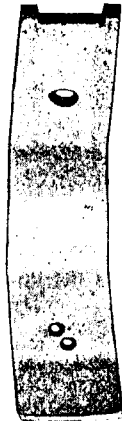
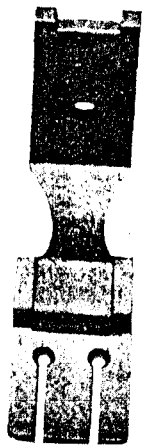
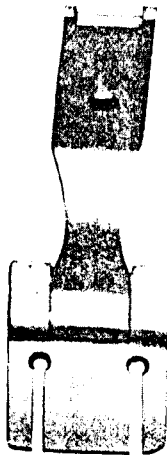


PLATE 13095--FULL SIZE

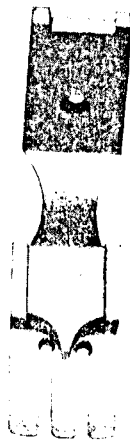
229262



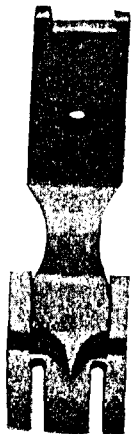
229264



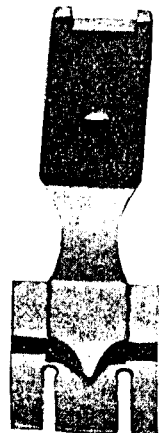
229278



229280



229282



229284

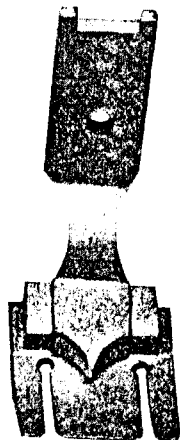


PLATE 14009--FULL SIZE

229493



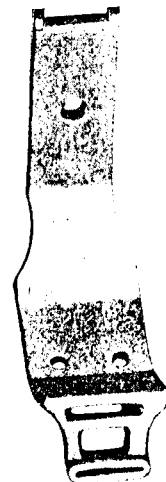
229493



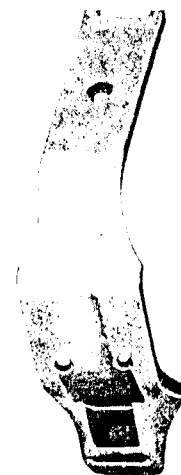
229494



229495



229495



229494

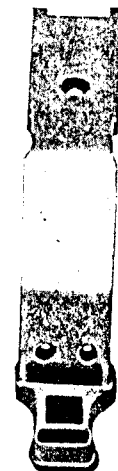
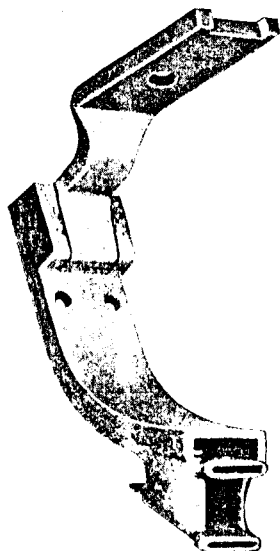
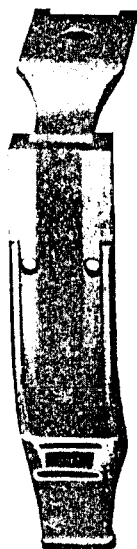


PLATE 14010—FULL SIZE

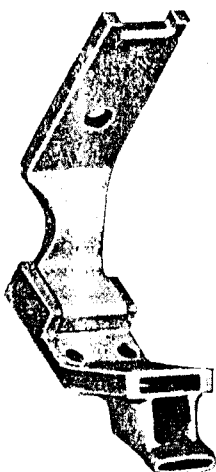
229497



229497



229499



229499

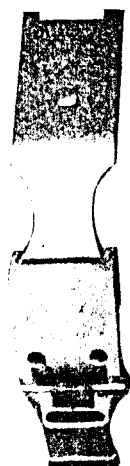
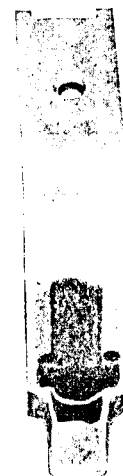


PLATE 14011—FULL SIZE

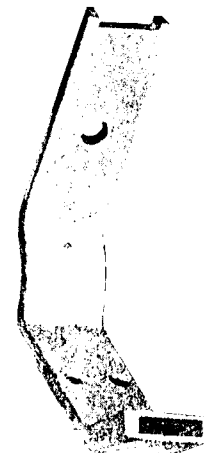
229500



229500



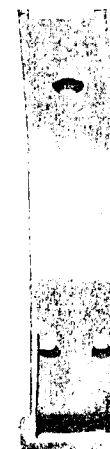
229501



229502



229502



229501



PLATE 14012—FULL SIZE

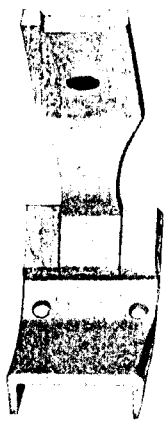
229505



229505



229511

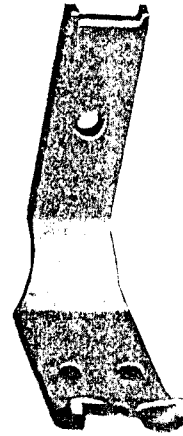


229509



PLATE 14021—FULL SIZE

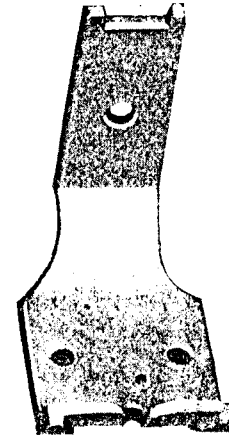
229533



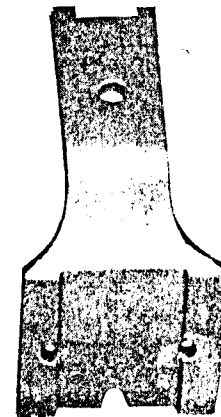
229533



229534
229584



229534
229584



229535



229535



PLATE 14022-FULL SIZE

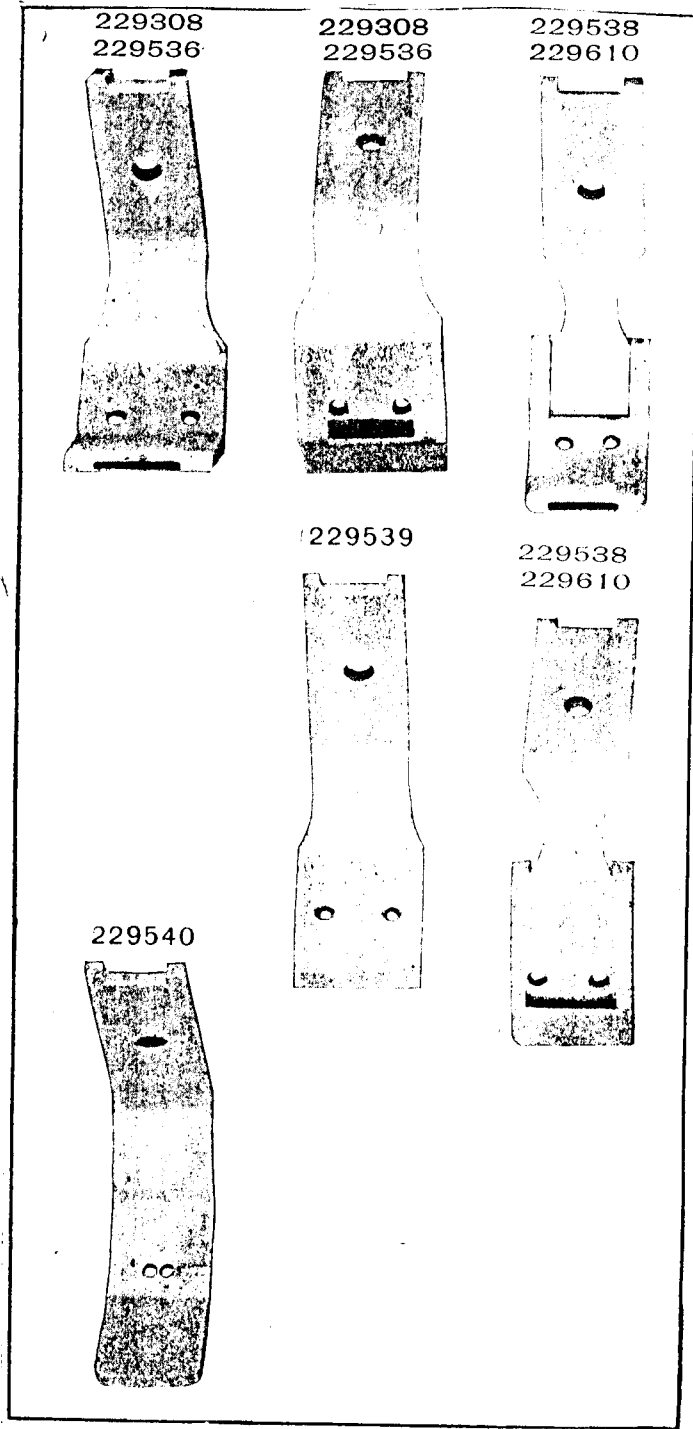


PLATE 14026-FULL SIZE

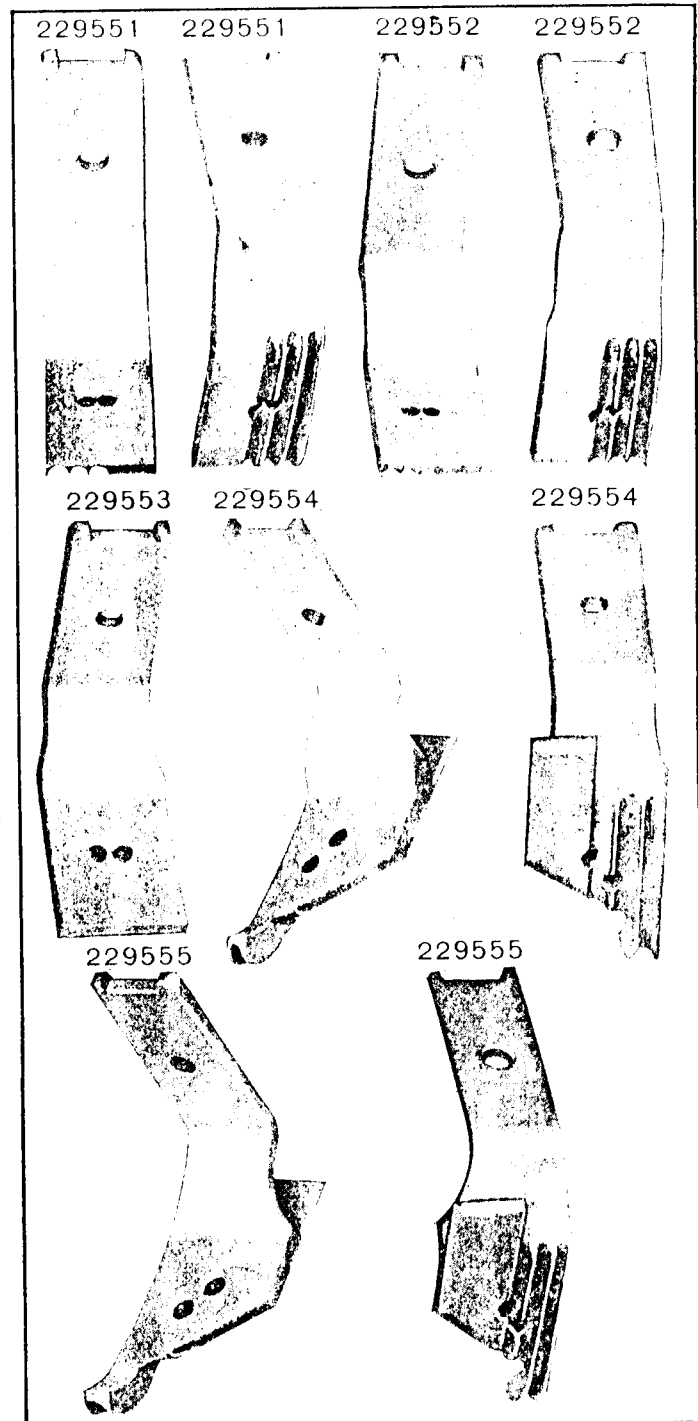


PLATE 14027—FULL SIZE

229556



229556



229558



229558

