

SINGER
246-3

Form 20447

(350)

Printed in U. S. A.

LIST OF PARTS



MACHINE No. 246-3

** A TRADE MARK OF
THE SINGER MANUFACTURING COMPANY

INDEX

INSTRUCTIONS FOR OILING

To ensure easy running and prevent unnecessary wear of the parts which are in movable contact, the machine requires oiling and when in continuous use, the oil gauge should be checked daily. The oil level should be maintained at the midpoint of the gauge.

To oil the machine, apply "TYPE A" OIL, sold only by Singer Sewing Machine Company, to the oil filler cup on top of the machine, as instructed in Form 20182.

	Page
Accessories.....	42
Belt Guard (Adjustable).....	42
Chip Chute.....	42
Fittings Complete No. 164270.....	19
Fittings Complete No. 164266.....	20
Fittings Complete No. 164271.....	21
Fittings Complete No. 164272.....	23
Fittings Complete No. 164273.....	25
Fittings Complete No. 164274.....	27
Fittings Complete No. 164332.....	29
Fittings Complete No. 164344.....	30
Fittings Complete No. 164388.....	31
Fittings Complete No. 164389.....	32
Fittings Complete No. 164390.....	33
Fittings Complete No. 164395.....	34
Fittings Complete No. 164431.....	36
Fittings Complete No. 164435.....	37
Fittings Complete No. 164437.....	39
Fittings Complete No. 164451.....	41
Foot Lifter Parts.....	43
Machine Base.....	43
Machine No. 246-3.....	7
Numerical List of Parts.....	45
Thread Unwinder No. 151031.....	43

INSTRUCTIONS FOR ORDERING

In ordering from this list, use ONLY the part NUMBER in the FIRST Column.

The number stamped on a Sewing Machine Part is in every case the number of the single part only.

Every combination of parts sent out as such has its specific number, which, although not stamped on the parts, must be used when ordering the combination.

Each number always indicates the SAME PART in whatever list it appears, or for whatever machine.

The letters after some of the numbers indicate the style of finish only, as follows:

- A-Hardened, Polished, Nickel Plated and Buffed.
- A.A-Buffered and Chromium Plated.
- A.B-Hardened, Polished, Buffed and Chromium Plated.
- A.C-Brown Baking Enamel Finish.
- A.D-Gray Baking Enamel Finish.
- A.E-Hardened, Bright Rumbled and Nickel Plated.
- A.F-Hardened, Bright Rumbled, Nickel Plated, Bright Rumbled and Chromium Plated.
- A.G-Alumilite, Plain.
- A.H-Alumilite Dyed.
- A.J-Polished, Nickel Plated and Chromium Plated.
- A.K-Hardened, Polished, Nickel Plated and Chromium Plated.
- A.L-Heat Treated for Toughness.
 - B-Polished, Nickel Plated and Buffed.
 - C-Hardened only.
- C.R-Hardened and Merlized.
 - D-Polished Only.
 - E-Soft, Not Polished.
 - F-Hardened and Polished.
- F.J-Hardened, Polished and Nickel Plated.
 - G-Bright Rumbled and Nickel Plated.
 - H-Blued.
 - J-Nickel Plated Only.
 - K-Hardened and Nickel Plated.
 - L-Brass Plated.
 - M-Oxidized.
 - N-Japanned, Dull.

INSTRUCTIONS FOR ORDERING - Continued

- P-Japanned, Bright.
- P.P-Wrinkle Finish.
- R-Merlized.
- S-Cadmium Plated.
- T-Copper Plated.
- T.A-Hardened, Polished, Copper and Nickel Plated and Buffed.
- T.B-Copper and Nickel Plated and Polished.
- T.J-Copper and Nickel Plated Only.
- T.K-Hardened, Copper and Nickel Plated.
- T.L-Copper and Brass Plated.
- T.M-Copper Plated and Oxidized.
- U-Zinc Plated.
- V-Silver Plated.
- W-Polished and Nickel Plated.
- X-Black Oxide, for Iron and Steel.
- X.C-Hardened and Black Oxide, for Iron and Steel.
- Y-Black Nickel Plated Only.
- Z-Chromium Plated.
- Z.A-Hardened, Polished, Nickel Plated, Buffed and Chromium Plated.
- Z.B-Polished, Nickel Plated, Buffed and Chromium Plated.
- Z.C-Hardened and Chromium Plated.
- Z.D-Polished and Chromium Plated.
- Z.G-Bright Rumbled, Nickel Plated, Bright Rumbled and Chromium Plated.
- Z.J-Nickel and Chromium Plated.
- Z.T-Copper and Chromium Plated.

These letters MUST BE USED when they appear in the list; and AFTER the number as in the list.

In this series:

1 to 1500, 50001 to 51500 and 140001 to 142000 are Screw Numbers.

1501 to 1800 and 51501 to 51800 are Nut Numbers.

1801 to 2000 and 51801 to 52000 are Roller Numbers.

2001 to 50000 and 52001 to 140000 and 142001 to 190000 are Sewing Machine Parts, 190001 and upward are numbers of Electrical Parts.

The figures in the second column refer only to the plates, illustrating the parts, and are NOT TO BE USED in ordering.

Parts marked with an asterisk (*) are furnished only when repairs are made at factory.

LIST OF PARTS COMPLETE

FOR

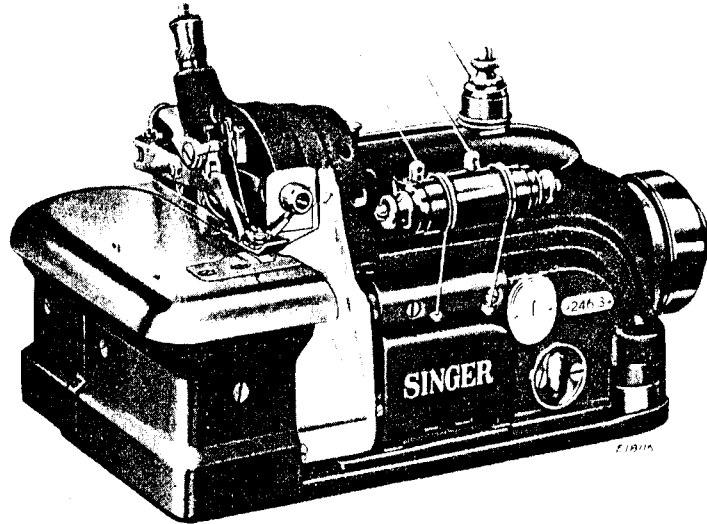

MACHINE No. 246-3

FOR TRIMMING AND OVEREDGING LIGHT
AND MEDIUM WEIGHT FABRICS.

ONE NEEDLE, TWO LOOPERS,
GATHERING FEED. TRIMMER.

SPEED UP TO 5500, DEPENDING ON MATERIALS

USED AND OPERATIONS PERFORMED.

No.	Plate	Name
164001	24767	Chip Guard.....
1209J	24767	" " Screw (lower).....
140509J	24767	" " " (upper).....
164107	24767	Cloth Plate.....
164002	24767	" " Extension.....
914J	24767	" " " Screw (2).....
164205	24767	" " Lock Spring.....
1700J	24767	" " " Nut.....
1250AL	24767	" " " " Screw Stud..
164104	24767	" " Plunger.....
164105	24767	" " " Spring.....
624AL	24767	" " " Set Screw.....
164106	24767	" " Position Collar with two 624AL.....
624AL	24767	Cloth Plate Position Collar Set Screw (2).....

No.	Plate	Name
164108	24767	Cloth Plate with Extension complete, Nos. 1700J, 164002, 164107, 164205 and two 914J.....
164003	24752	Feed Bar Hinge Pin (eccentric).....
1389C	24752	" " " " Set Screw.....
164004	24752	" " Slide Block (back) (2).....
1628C	24752	" " " " " Nut.....
17022	24752	" " " " " Washer.....
164005	24752	Feed Bar Slide Block (front).....
164016	24752	" (back) Bar with 164010.....
164017	24752	" " " Connection.....
164008	24752	" " " " " Bearing..
164009	24752	" " " " " Hinge Screw Stud.....
1671C	24752	Feed (back) Bar Connection Hinge Screw Stud Nut.....
164010	24752	Feed (back) Bar Connection Hinge Screw Stud Nut Position Pin.....
164011	24771	Feed (back) Dog Section (left).....
164012	24771	" " " " (right).....
1100AL	24771	" " " " " Screw.....
164013	24771	Feed (back) Dog complete, Nos. 1100AL, 164011 and 164012.....
1454F	24771	Feed (back) Dog Screw.....
164020	24752	" " Eccentric.....
		Note: Feed (back) Eccentric No. 164020 is furnished in 6 to 16, 18, 20, 22, 24, 28, 32 and 36 stitches to the inch, unless otherwise stated No. 164020 (14 stitches to the inch) is supplied regularly.
164006	24752	Feed (front) Bar with 164010.....
164007	24752	" " " Connection.....
164018	24752	" " " " " Bearing.
164009	24752	" " " " " Hinge Screw Stud.....
1671C	24752	Feed (front) Bar Connection Hinge Screw Stud Nut.....
164010	24752	Feed (front) Bar Connection Hinge Screw Stud Nut Position Pin.....
164208	-----	Feed (back) and (front) Bars complete, Nos. 164005, 164006, 164007, 164008, 164016, 164017, 164018 and two each 1671C, 164004 and 164009.....
164019	24771	Feed (front) Dog.....
1454F	24771	" " " Screw.....
164020	24752	" " Eccentric.....
		Note: Feed (front) Eccentric No. 164020 is furnished in 6 to 16, 18, 20, 22, 24, 28, 32 and 36 stitches to the inch, unless otherwise stated No. 164020 (14 stitches to the inch) is supplied regularly.

No.	Plate	Name
164398	24752	Feed Eccentric Cover.....
164399	24752	" " " Bracket.....
157C	24752	" " " " Screw..
629K	24752	" " " Hinge Screw....
164401	24752	" " " Latch Spring...
227J	24752	" " " " " Screw (2).....
164023	24752	Feed Eccentric Oil Wick.....
164402	24752	Feed Eccentric Cover complete, Nos. 629K, 164023, 164398, 164399, 164401 and two 227J.....
164025	24755	Feed Lifting and Knife (movable) Eccentric.....
164026	24768	Knife (movable) (2).....
164027	24768	" " Clamp.....
140050C	24768	" " " Screw.....
164028	24768	" " Guard (lower).....
164458	24768	" " " (upper).....
164029	24768	" " Holder.....
198J	24768	" " " Screw.....
164030	24768	" " " " Bearing
164031	24768	" " Lever with 620AL....
164211	-----	" " " 164031 with 132583, 164035, 164136 and 164153
164032	24768	Knife (movable) Lever Bearing.....
50421AL	24768	" " " " Set Screw (long).....
624AL	24768	Knife (movable) Lever Bearing Set Screw (short).....
164246	24770	Knife (movable) Lever Cover and Presser Bar (upright) Housing...
50073J	24770	Knife (movable) Lever Cover and Presser Bar (upright) Housing Screw (2).....
164247	-----	Knife (movable) Lever Cover and Presser Bar (upright) Housing complete, Nos. 50060K, 164137, 164138, 164139, 164142, 164143, 164144, 164194 and 164246.....
164180	24768	Knife (movable) Lever Guide.....
164181	24768	" " " " Holder with two 140239AL.....
164210	24768	Knife (movable) Lever Guide Holder 164181 with 197J, 164177, 164180 and 164182.....
140239AL	24768	Knife (movable) Lever Guide Holder Set Screw (2).....
164182	24768	Knife (movable) Lever Guide Holder Thread Tube.....
50421AL	24768	Knife (movable) Lever Guide Holder Thread Tube Set Screw.....
197J	24768	Knife (movable) Lever Guide Screw...
132583	24768	" " " Hinge Pin with 132584.....

No.	Plate	Name
132584	24768	Knife (movable) Lever Hinge Pin Oil Wick.....
620AL	24768	Knife (movable) Lever Hinge Pin Set Screw.....
164034	24768	Knife (movable) Lever Hinge Stud....
164035	-----	" " " " " " 164034 with 164036 and 164269...
164036	24768	Knife (movable) Lever Hinge Stud Oil Wick (long).....
164269	-----	Knife (movable) Lever Hinge Stud Oil Wick (short).....
50421AL	24768	Knife (movable) Lever Hinge Stud Set Screw (back).....
1143AL	24768	Knife (movable) Lever Hinge Stud Set Screw (top).....
164233	24768	Knife (stationary).....
164038	24768	" " Clamping Stud....
51715AL	24768	" " " " Nut
164039	24768	" " Holder.....
164040	24768	" " " Adjusting Stud.....
1454E	24768	Knife (stationary) Holder Adjusting Stud Cap Screw.....
39541	24768	Knife (stationary) Holder Adjusting Stud Cap Screw Washer.....
164041	24768	Knife (stationary) Holder Cap.....
164042	24768	" " " Sleeve....
140088R	24768	" " " " Screw.....
59456	24768	Knife (stationary) Holder Sleeve Screw Washer.....
164043	24768	Knife (stationary) Holder Spring....
164044	24768	" " " " Re-tainer.....
1454J	24768	Knife (stationary) Holder Spring Re-tainer Screw.....
164045	24769	Looper (left hand) <i>Bottom</i>
164046	24769	" " " Carrier with 460AL, 50379F and 164202.....
164047	24769	Looper (left hand) Carrier Holder with two 140393AL.....
164212	-----	Looper (left hand) Carrier Holder 164047 with 1324C, 59456 and 164046.....
140393AL	24769	Looper (left hand) Carrier Holder Set Screw (2).....
1324C	24769	Looper (left hand) Carrier Screw....
460AL	24769	" " " " " Set Screw.....
59456	24769	Looper (left hand) Carrier Screw Washer.....
164048	24769	Looper (left hand) Driving Shaft....
164049	24769	" " " " " Bushing (back).....
140394E	24769	Looper (left hand) Driving Shaft Bushing (back) Cap Screw.....

No.	Plate	Name
164293	24769	Looper (left hand) Driving Shaft Bushing (back) Cap Screw Washer (fiber).....
164050	24769	Looper (left hand) Driving Shaft Bushing (front).....
164051	24769	Looper (left hand) Driving Shaft Crank with 1083C.....
164215	-----	Looper (left hand) Driving Shaft Crank 164051 with 164052.....
1083C	24769	Looper (left hand) Driving Shaft Crank Clamping Screw.....
164052	24755	Looper (left hand) Driving Shaft Crank Connection with two each 171AL and 140159AL.....
171AL	24755	Looper (left hand) Driving Shaft Crank Connection Cap (lower) Screw (2).....
140159AL	24755	Looper (left hand) Driving Shaft Crank Connection Cap (upper) Screw (2).....
164067	24769	Looper (left hand) Driving Shaft Crank Key.....
1324C	24769	Looper (left hand) Driving Shaft Crank Key Screw.....
45057	24769	Looper (left hand) Driving Shaft Crank Key Screw Washer.....
164053	24769	Looper (left hand) Driving Shaft Crank Thrust Bearing.....
50379F	24769	Looper (left hand) Set Screw.....
164202	24769	" " " Stop Pin.....
164054	24771	" " " Thread Tube.....
853AL	24771	" " " " " Set Screw.....
164055	24769	Looper (right hand).....
164056	24769	" " " Carrier with 50370E.....
164057	24769	Looper (right hand) Carrier Connection.....
164058	24769	Looper (right hand) Carrier Connection Guide Bar with 624AL and 168215.....
168215	-----	Looper (right hand) Carrier Connection Guide Bar Oil Wick.....
624AL	24769	Looper (right hand) Carrier Connection Guide Bar Plug Screw.....
164059	24769	Looper (right hand) Carrier Connection Guide Bar Bracket with 164060 and two 462AL.....
164060	24769	Looper (right hand) Carrier Connection Guide Bar Bracket Oil Pad..
914C	24769	Looper (right hand) Carrier Connection Guide Bar Bracket Screw (left).....
1057AL	24769	Looper (right hand) Carrier Connection Guide Bar Bracket Screw (right).....

No.	Plate	Name
462AL	24769	Looper (right hand) Carrier Connection Guide Bar Set Screw (2)....
164061	24769	Looper (right hand) Carrier Connection Hinge Stud with 1019AL.....
1443J	24769	Looper (right hand) Carrier Connection Hinge Stud Cap Screw.....
164397	24769	Looper (right hand) Carrier Connection Hinge Stud Adjusting Pin...
1019AL	24769	Looper (right hand) Carrier Connection Hinge Stud Adjusting Pin Set Screw.....
132565	24769	Looper (right hand) Carrier Hinge Pin.....
50370E	24769	Looper (right hand) Carrier Hinge Pin Set Screw.....
164062	24769	Looper (right hand) Driving Lever with 1083C and two 140393AL.....
164213	-----	Looper (right hand) Driving Lever 164062 with 1443J, 1700J, 132565, 164056, 164057, 164058, 164059, 164061, 164068 and 164397.....
1083C	24769	Looper (right hand) Driving Lever Clamping Screw.....
140393AL	24769	Looper (right hand) Driving Lever Set Screw (2).....
164063	24769	Looper (right hand) Driving Shaft...
164049	24769	" " " " " "
		Bushing (back).....
140394E	24769	Looper (right hand) Driving Shaft Bushing (back) Cap Screw.....
164293	24769	Looper (right hand) Driving Shaft Bushing (back) Cap Screw Washer (fiber).....
164065	24769	Looper (right hand) Driving Shaft Bushing (front).....
164066	24769	Looper (right hand) Driving Shaft Crank with 1083C.....
164216	-----	Looper (right hand) Driving Shaft Crank 164066 with 164052.....
1083C	24769	Looper (right hand) Driving Shaft Crank Clamping Screw.....
164052	24755	Looper (right hand) Driving Shaft Crank Connection with two each 171AL and 140159AL.....
171AL	24755	Looper (right hand) Driving Shaft Crank Connection Cap (lower) Screw (2).....
140159AL	24755	Looper (right hand) Driving Shaft Crank Connection Cap (upper) Screw (2).....
164067	24769	Looper (right hand) Driving Shaft Crank Key.....
1324C	24769	Looper (right hand) Driving Shaft Crank Key Screw.....

No.	Plate	Name
45057	24769	Looper (right hand) Driving Shaft Crank Key Screw Washer.....
164053	24769	Looper (right hand) Driving Shaft Crank Thrust Bearing.....
164068	24769	Looper (right hand) Locking Screw Stud.....
1700J	24769	Looper (right hand) Locking Screw Stud Nut.....
164219	24769	Looper (right hand) Position Collar with 904E.....
904E	24769	Looper (right hand) Position Collar Set Screw.....
*164072	-----	Machine Frame.....
*164073	-----	Machine Frame complete, Nos. 45773, 140396E, 164072, 164077, 164218, two 15405 and three 140395C.....
164074	24756	Machine Frame Bottom Cover.....
164075	24756	" " " " Gasket...
914C	24756	" " " " Screw (13).....
*164076	-----	Machine Frame Bracket.....
*164218	-----	" " " " 164076 with 164207 and two 187E.....
164207	24759	Machine Frame Bracket Key.....
187E	24759	" " " " Screw (2).
140396E	24759	" " " " Screw (large).
164077	24759	" " " " " "
		Washer (fiber).....
164229	24759	Machine Frame Bracket Screw (large) Washer (felt).....
140395C	24759	Machine Frame Bracket Screw (small) (3).....
164078	24756	Machine Frame Cover (back).....
50571J	24756	" " " " " Screw (long) (2).....
914J	24756	Machine Frame Cover (back) Screw (short).....
164079	24756	Machine Frame Cover (back) Slide....
140200J	24756	" " " " " " Position Screw.....
238J	24756	Machine Frame Cover (back) Slide Stop Screw.....
164080	24756	Machine Frame Cover (back) complete, Nos. 238J, 1637K, 140200J, 140228K, 164078 and 164079.....
164081	24759	Machine Frame Oil Lead.....
140088R	24759	" " " " " Screw.....
1698J	24759	" " " " " Nut....
164082	24759	" " " " Plug Bracket.....
1036AL	24759	" " " " " " Set Screw.....
51285E	24759	Machine Frame Oil Plug Screw.....
164313	24759	" " " " " " Washer (Steel).....
164314	24759	Machine Frame Oil Plug Screw Washer (Cork).....

No.	Plate	Name
164083	24759	Machine Frame Oil Screen.....
206J	24759	" " " " Screw.....
164084	24759	" " " Splash Guard (in- ternal).....
206J	24759	Machine Frame Oil Splash Guard (in- ternal) Screw (2).....
164085	24770	Machine Frame Oil Splash Guard (top)
51023W	24770	" " " " " " " Screw (2).....
164086	24759	Machine Frame Oil Tube with 164087..
50421AL	24759	" " " " " Set Screw....
164087	24759	" " " " " Wick.....
164461	-----	" " " " " Retainer
164088	24755	" " Plug.....
164089	24755	" " Rotary Shaft.....
164090	-----	" " " " " 164089 with 164097, 164215, 164216, 164217 and two each 164093 and 164232.....
139026	24755	Machine Frame Rotary Shaft Ball Bearing.....
164092	24755	Machine Frame Rotary Shaft Ball Bearing Housing.....
51369C	24755	Machine Frame Rotary Shaft Ball Bearing Housing Screw (3).....
164093	24755	Machine Frame Rotary Shaft Ball Sleeve (two pieces) (2).....
164232	24755	Machine Frame Rotary Shaft Ball Sleeve Guide (2).....
164094	24755	Machine Frame Rotary Shaft Bushing (front).....
1036AL	24755	Machine Frame Rotary Shaft Bushing (front) Set Screw.....
164095	24755	Machine Frame Rotary Shaft Bushing (intermediate).....
51332C	24755	Machine Frame Rotary Shaft Bushing (intermediate) Set Screw.....
164096	24755	Machine Frame Rotary Shaft Counter- balance with 1036AL.....
1036AL	24755	Machine Frame Rotary Shaft Counter- balance Set Screw.....
164097	24755	Machine Frame Rotary Shaft Key.....
51649C	24755	" " " " " Nut.....
131056	24755	" " " " " Wash- er.....
164098	24755	Machine Frame Rotary Shaft Oil Sling and Ball Bearing Grease Retainer
164099	24755	Machine Frame Rotary Shaft Screw Stud.....
164100	24755	Machine Frame Rotary Shaft Thrust Bearing.....
164101	24772	Machine Frame Top Cover.....
164214	-----	" " " " " 164101 with 330J, 164103 and two 164418.....
164102	24772	Machine Frame Top Cover Gasket.....
164103	24772	" " " " " Oil Lead....

No.	Plate	Name
330J	24772	Machine Frame Top Cover Oil Lead Screw.....
51369J	24772	Machine Frame Top Cover Screw (3)...
164231	24755	" Pulley (round and "V" belt) with two 448AL.....
164071	24755	Machine Pulley Cap.....
140416X	24755	" " " Screw.....
448AL	24755	" " " Set Screw (2).....
164109	24770	Needle Clamp.....
51720C	24770	" Clamping Nut.....
164110	24770	" Driving Shaft with 164118....
164275	-----	" " " 164110 with 51720C, 164109 and 164117.....
164111	24770	Needle Driving Shaft Bushing.....
164112	24770	" " " " Cap....
164113	24770	" " " " " Oil Lead.....
452C	24770	Needle Driving Shaft Bushing Oil Lead Hole Plug Screw.....
164114	24770	Needle Driving Shaft Crank with 1083C and two 140393AL.....
164115	24770	Needle Driving Shaft Crank Ball....
1083C	24770	" " " " " Clamping Screw.....
164116	24755	Needle Driving Shaft Crank Connec- tion with two each 171AL and 140159AL.....
164217	-----	Needle Driving Shaft Crank Connec- tion 164116 with 164115.....
140159AL	24755	Needle Driving Shaft Crank Connec- tion Cap (lower) Screw (2).....
171AL	24755	Needle Driving Shaft Crank Connec- tion Cap (upper) Screw (2).....
140393AL	24770	Needle Driving Shaft Crank Set Screw (2).....
164117	24770	Needle Holder.....
164118	24770	" Stop Pin.....
164119	24755	Oil Agitator.....
164120	24759	" Cooler with two 164125.....
164121	24759	" " Cover.....
164123	24759	" " " 164121 with 164135..
164122	24759	" " " Gasket.....
145J	24759	" " " Screw.....
164124	24759	" " Gasket.....
164125	24759	" " Oil Pipe (outlet) (2)....
164126	24759	" " " Tube with 138269 and 164128.....
164127	24759	Oil Cooler Oil Tube Coupling.....
51630	24759	" " " Lock Nut.....
138269	24759	" " " Sleeve.....
164128	24759	" " " Wick.....
51139J	24759	" " " Screw (long) (2).....
1324J	24759	" " " (short).....
164131	24759	" Sight Gauge Background Disc....
164132	24759	" " " " " Gas- ket.....

No.	Plate	Name
164133	24759	Oil Sight Gauge Window.....
164132	24759	" " " " Gasket.....
164134	24759	" " " " Retainer.....
164132	24759	" " " " Gas- ket.....
1485J	24759	Oil Sight Gauge Window Retainer Screw (2).....
164135	24759	Oil Cup for filling machine.....
164136	24768	Presser Bar Bracket.....
164137	24770	" " Lifting Bracket with 462AL, 624AL and 51846.....
51846	24770	Presser Bar Lifting Bracket Roller and Stud.....
624AL	24770	Presser Bar Lifting Bracket Set Screw (long).....
462AL	24770	Presser Bar Lifting Bracket Set Screw (short).....
164138	24770	Presser Bar Lifting Lever.....
164139	24770	" " " " Spring.....
140228K	24756	" " " " Stop Screw
1637K	24756	" " " " " "
		Nut.....
164350	24768	Presser Bar (swing-out).....
164141	24768	" " " Lifting Screw Stud.....
1700J	24768	Presser Bar (swing-out) Lifting Screw Stud Nut.....
164142	24770	Presser Bar (swing-out) Opening Lev- er.....
50060K	24770	Presser Bar (swing-out) Opening Lev- er Hinge Screw.....
140510C	24768	Presser Bar (swing-out) Pivot Screw.
164351	24768	" " " " "
		Lock Washer.....
51362AL	24768	Presser Bar (swing-out) Pivot Screw Lock Washer Screw.....
164143	24770	Presser Bar (upright).....
164144	24770	" " " Spring.....
164145	24771	" Foot Body.....
164220	24771	" " Chain Cutter Friction Plate.....
164221	24771	Presser Foot Chain Cutter Knife.....
51306E	24771	" " " " "
		Screw.....
164146	24771	Presser Foot Chaining-off Finger.....
164147	24771	" " Clamping Plate.....
50225J	24771	" " " " Screw...
164149	24771	" " Guide.....
50169J	24771	" " " Screw.....
164150	24771	Presser Foot with Chain Cutter com- plete, Nos. 50169J, 50225J, 51306E, 164145, 164146, 164147, 164149, 164220 and 164221.....
164317	24771	Presser Bar (swing-out) with Presser Foot complete, Nos. 1700J, 164141, 164150 and 164350.....

No.	Plate	Name
164194	24770	Pressure Regulating Thumb Screw....
2102	24772	Tension (heavy) Disc (4).....
164155	24772	" " " " Regulating Thumb Nut (2).....
50133C	24772	Tension (heavy) Screw Stud (2).....
164156	-----	" " " " 50133C with 164155 (2).....
164161	24772	Tension (heavy) Spring (2).....
59537	24772	" " " Bushing (2)..
164158	24772	" " " Cover (2)....
164162	24772	Tension (heavy) complete, Nos. 59537, 164156, 164158, 164161 and two 2102 (2).....
2102	24772	Tension (light) Disc (2).....
164155	24772	" " " " Regulating Thumb Nut
50133C	24772	" " " " Screw Stud.....
164156	-----	" " " " 50133C with 164155.....
164157	24772	Tension (light) Spring.....
59537	24772	" " " Bushing.....
164158	24772	" " " Cover.....
164160	24772	Tension (light) complete, Nos. 59537, 164156, 164157, 164158 and two 2102.....
164285	24772	Tension (looper thread) Thread Guide (left).....
164286	24772	Tension (looper thread) Thread Guide (right).....
164159	24772	Tension (needle thread) Thread Guide
164418	24772	" Thread Eyelet (2).....
164091	24769	Thread (looper, right hand) Stripper and Take-up.....
164163	24761	Thread (looper, right hand) Stripper and Take-up Eyelet (adjustable).
1443J	24761	Thread (looper, right hand) Stripper and Take-up Eyelet (adjustable) Screw.....
187E	24769	Thread (looper, right hand) Stripper and Take-up Screw.....
17022	24769	Thread (looper, right hand) Stripper and Take-up Screw Washer.....
164164	24761	Thread (looper, right hand) Thread Eyelet (movable).....
1423J	24761	Thread (looper, right hand) Thread Eyelet Screw.....
164165	24761	Thread (looper, right hand) Thread Eyelet (stationary).....
1607J	24761	Thread (looper, right hand) Thread Eyelet (stationary) Nut.....
164166	24761	Thread (looper, right hand) Tube....
624AL	24761	" " " " " Set Screw.....
164167	24761	Thread (looper) Plate with 624AL....
164168	24761	" " " " Cover.....
164206	-----	" " " " 164168 with 164169 and 164170.....

No.	Plate	Name
164169	24761	Thread (looper) Plate Cover Hinge...
164170	24761	" " " " " "
		Pin.....
164171	24761	Thread (looper) Plate Cover Spring (2).....
332J	24761	Thread (looper) Plate Cover Spring Screw (2).....
896AL	24761	Thread (looper) Plate Screw (2).....
164173	24761	" " " Thread Bushing
50318W	24761	" " " " "
		Screw.....
164174	-----	Thread (looper) Plate complete, Nos. 1423J, 1443J, 1607J, 50318W, 164163, 164164, 164165, 164166, 164167, 164173, 164206 and two each 332J and 164171.....
164175	24769	Thread (looper) Take-up.....
164176	24769	" " " Plate.....
176E	24769	" " " Screw (lower).....
1443W	24769	Thread (looper) Take-up Screw (upper).....
164151	24768	Thread (needle) Controller.....
164153	24768	" " " Lever....
1443B	24768	" " " Screw (2)
164177	24768	" Eyelet (needle thread).....
140239AL	24768	" " " " Set Screw.....
164178	24771	Throat Plate.....
164179	24771	" " Guide with 853AL.....
1454E	24771	" " Screw.....
1094F	24771	" " Screw (2).....
*45773	-----	Trade Mark.....
15405	-----	" " Rivet (2).....

SINGER Needles should be used in SINGER Machines. These Needles and their Containers are marked with the Company's Trade Mark "SIMANCO.**" 1

Needles in Containers marked "FOR SINGER MACHINES" are NOT **SINGER** made needles. 2

SET OF FITTINGS COMPLETE

No. 164270

FOR

Rayon, Glove Silk and Lightweight Materials

For Three-Thread Tight Stitch

For 1/8 inch Bight

Note: This Machine is regularly fitted with Set No. 164270, unless other Fittings are specified on order.

No.	Plate	Name
164011	24773	Feed (back) Dog Section (left).....
164012	24773	" " " " (right).....
1100AL	24773	" " " " "
		Screw.....
164013	24773	Feed (back) Dog complete, Nos. 1100AL, 164011 and 164012.....
164019	24773	Feed (front) Dog.....
164026	24773	Knife (movable).....
164055	24773	Looper (right hand).....
164350	24773	Presser Bar (swing-out).....
164141	24773	" " " Lifting Screw Stud.....
1700J	24773	Presser Bar (swing-out) Lifting Screw Stud Nut.....
164145	24773	Presser Foot Body.....
164220	24773	" " Chain Cutter Friction Plate.....
164221	24773	Presser Foot Chain Cutter Knife.....
51306E	24773	" " " " " Screw.....
164146	24773	Presser Foot Chaining-off Finger....
164147	24773	" " Clamping Plate.....
50225J	24773	" " " Screw...
164149	24773	" " Guide.....
50169J	24773	" " " Screw.....
164150	24773	Presser Foot with Chain Cutter complete, Nos. 50169J, 50225J, 51306E, 164145, 164146, 164147, 164149, 164220 and 164221.....
164317	24773	Presser Bar (swing-out) with Presser Foot complete, Nos. 1700J, 164141, 164150 and 164350.....
164175	24773	Thread (looper) Take-up.....
164091	24773	" (looper, right hand) Stripper and Take-up.....
164151	24773	Thread (needle) Controller.....
164178	24773	Throat Plate.....
164179	24773	" " Guide with 853AL.....
164270	24773	Set of Fittings complete, Nos. 164013, 164019, 164026, 164055, 164091, 164151, 164175, 164178, 164179 and 164317.....

SET OF FITTINGS COMPLETE

No. 164266

FOR

Lingerie, Crepe de Chine, Silk and Rayon

For Three-Thread Tight Stitch

For $\frac{3}{32}$ inch Bight

No.	Plate	Name
164254	24774	Feed (back) Dog Section (left).....
164255	24774	" " " " (right).....
1100AL	24774	" " " " " "
		Screw.....
164256	24774	Feed (back) Dog complete, Nos. 1100AL, 164254 and 164255.....
164257	24774	Feed (front) Dog.....
164258	24774	Presser Bar (swing-out).....
164259	24774	" Foot Body.....
164260	24774	" " Chain Cutter Friction Plate.....
164261	24774	Presser Foot Chain Cutter Knife.....
51306E	24774	" " " " " "
		Screw.....
164262	24774	Presser Foot Chaining-off Finger....
164263	24774	" " Clamping Plate.....
50225J	24774	" " " " Screw....
164264	24774	Presser Foot with Chain Cutter com- plete, Nos. 50225J, 51306E, 164259, 164260, 164261, 164262 and 164263.....
164265	24774	Throat Plate.....
164268	24774	" " Guide with 853AL.....
164266	24774	Set of Fittings complete, Nos. 164256, 164257, 164258, 164264, 164265 and 164268.....

Note: When using Set of Fittings complete No. 164266, the following parts which are not included in this Set of Fittings, are necessary, if machine has previously been fitted other than regular (see Set of Fittings No. 164270).

No.	Plate	Name
164026	24774	Knife (movable).....
164055	24774	Looper (right hand).....
164175	24774	Thread (looper, left hand) Take-up..
164091	24774	" (looper, right hand) Take-up.
164151	24774	" (needle) Controller.....

SET OF FITTINGS COMPLETE

No. 164271

FOR

Rayon, Glove Silk and Lightweight Materials

For Three-Thread Tight Stitch

For $\frac{3}{32}$ inch Bight

Note: No. 164271 Set of Fittings complete is numbered only for Identifying purposes in the factory. It is not necessary for Agencies to order this number when converting a machine in the field, unless machine has been fitted other than regular, as part number 164267, Throat Plate, in place of part number 164178 is only part required.

No.	Plate	Name
164267	24775	Throat Plate.....

Note: When using Set of Fittings complete No. 164271, the following parts which are not included in this Set of Fittings, are necessary, if machine has previously been fitted other than regular (see Set of Fittings complete No. 164270).

No.	Plate	Name
164011	24775	Feed (back) Dog Section (left).....
164012	24775	" " " " (right).....
1100AL	24775	" " " " " "
		Screw.....
164013	24775	Feed (back) Dog complete, Nos. 1100AL, 164011 and 164012.....
164019	24775	Feed (front) Dog.....
164026	24775	Knife (movable).....
164055	24775	Looper (right hand).....
164350	24775	Presser Bar (swing-out).....
164141	24775	" " " Lifting Screw Stud.....
1700J	24775	Presser Bar (swing-out) Lifting Screw Stud Nut.....
164145	24775	Presser Foot Body.....
164220	24775	" " Chain Cutter Friction Plate.....
164221	24775	Presser Foot Chain Cutter Knife.....
51306E	24775	" " " " " "
		Screw.....
164146	24775	Presser Foot Chaining-off Finger....

No.	Plate	Name
164147	24775	Presser Foot Clamping Plate.....
50225J	24775	" " " " Screw...
164149	24775	" " Guide.....
50169J	24775	" " " Screw.....
164150	24775	Presser Foot with Chain Cutter complete, Nos. 50169J, 50225J, 51306E, 164145, 164146, 164147, 164149, 164220 and 164221.....
164317	24775	Presser Bar (swing-out) with Presser Foot complete, Nos. 1700J, 164141, 164150 and 164350.....
164175	24775	Thread (looper) Take-up.....
164091	24775	" (looper, right hand) Stripper and Take-up.....
164151	24775	Thread (needle) Controller.....
164179	24775	Throat Plate Guide with 853AL.....

SET OF FITTINGS COMPLETE

No. 164272

FOR

Light and Medium Sweater Materials

For Three-Thread Tight Stitch

For $\frac{3}{32}$ inch Bight

No.	Plate	Name
164222	24776	Feed (back) Dog Section (left).....
164223	24776	" " " " (right).....
1100AL	24776	" " " " " "
		Screw.....
164224	24776	Feed (back) Dog complete, Nos. 1100AL, 164222 and 164223.....
164225	24776	Feed (front) Dog.....
164308	24776	Knife (movable).....
164226	24776	Throat Plate.....
164272	24776	Set of Fittings complete, Nos. 164224, 164225, 164226 and 164308.....

Note: When using Set of Fittings complete No. 164272 the following parts which are not included in this Set of fittings, are necessary, if machine has previously been fitted other than regular (see Set of Fittings No. 164270).

No.	Plate	Name
164055	24776	Looper (right hand).....
164350	24776	Presser Bar (swing-out).....
164141	24776	" " " " Lifting
		Screw Stud.....
1700J	24776	Presser Bar (swing-out) Lifting
		Screw Stud Nut.....
164145	24776	Presser Foot Body.....
164220	24776	" " Chain Cutter Friction
		Plate.....
164221	24776	Presser Foot Chain Cutter Knife.....
51306E	24776	" " " " " "
		Screw.....
164146	24776	Presser Foot Chaining-off Finger....
164147	24776	" " Clamping Plate.....
50225J	24776	" " " " Screw...
164149	24776	" " Guide.....
50169J	24776	" " " Screw.....
164150	24776	Presser Foot with Chain Cutter complete, Nos. 50169J, 50225J, 51306E, 164145, 164146, 164147, 164149, 164220 and 164221.....

No.	Plate	Name
164317	24776	Presser Bar (swing-out) with Presser Foot complete, Nos. 1700J, 164141, 164150 and 164350.....
164175	24776	Thread (looper) Take-up.....
164091	24776	" (looper, right hand) Stripper and Take-up.....
164151	24776	Thread (needle) Controller.....
164179	24776	Throat Plate Guide with 853AL.....

SINGER Needles should be used
in SINGER Machines.
These Needles and their Containers
are marked with the
Company's Trade Mark "SIMANCO.***" 1

Needles in Containers marked
"FOR SINGER MACHINES"
are NOT **SINGER** made needles. 2

SET OF FITTINGS COMPLETE

No. 164273

FOR

Light and Medium Sweater Materials

For Three-Thread Tight Stitch

For 1/8 inch Bight

No.	Plate	Name
164222	24777	Feed (back) Dog Section (left).....
164223	24777	" " " " (right).....
1100AL	24777	" " " " " "
		Screw.....
164224	24777	Feed (back) Dog complete, Nos. 1100AL, 164222 and 164223.....
164225	24777	Feed (front) Dog.....
164308	24777	Knife (movable).....
164227	24777	Throat Plate.....
164273	24777	Set of Fittings complete, Nos. 164224, 164225, 164227 and 164308.....

Note: When using Set of Fittings complete No. 164273 the following parts which are not included in this Set of Fittings, are necessary, if machine has previously been fitted other than regular (see Set of Fittings No. 164270).

No.	Plate	Name
164055	24777	Looper (right hand).....
164350	24777	Presser Bar (swing-out).....
164141	24777	" " " Lifting Screw Stud.....
1700J	24777	Presser Bar (swing-out) Lifting Screw Stud Nut.....
164145	24777	Presser Foot Body.....
164220	24777	" " Chain Cutter Friction Plate.....
164221	24777	Presser Foot Chain Cutter Knife.....
51306E	24777	" " " " " Screw.....
164146	24777	Presser Foot Chaining-off Finger....
164147	24777	" " Clamping Plate.....
50225J	24777	" " " " Screw...
164149	24777	" " Guide.....
50169J	24777	" " " Screw.....
164150	24777	Presser Foot with Chain Cutter complete, Nos. 50169J, 50225J, 51306E, 164145, 164146, 164147, 164149, 164220 and 164221.....

No.	Plate	Name
164317	24777	Presser Bar (swing-out) with Presser Foot complete, Nos. 1700J, 164141, 164150 and 164350.....
164175	24777	Thread (looper) Take-up.....
164091	24777	" (looper, right hand) Stripper and Take-up.....
164151	24777	Thread (needle) Controller.....
164179	24777	Throat Plate Guide with 853AL.....

SET OF FITTINGS COMPLETE

No. 164274

FOR

Light and Medium Sweater Materials

For Three-Thread Tight Stitch

For $\frac{5}{32}$ inch Bight

No.	Plate	Name
164222	24778	Feed (back) Dog Section (left).....
164223	24778	" " " " (right).....
1100AL	24778	" " " " "
		Screw.....
164224	24778	Feed (back) Dog complete, Nos. 1100AL, 164222 and 164223.....
164225	24778	Feed (front) Dog.....
164308	24778	Knife (movable).....
164228	24778	Throat Plate.....
164274	24778	Set of Fittings complete, Nos. 164224, 164225, 164228 and 164308.....

Note: When using Set of Fittings complete No. 164274 the following parts which are not included in this Set of Fittings, are necessary, if machine has previously been fitted other than regular (see Set of Fittings No. 164270).

No.	Plate	Name
164055	24778	Looper (right hand).....
164350	24778	Presser Bar (swing-out).....
164141	24778	" " " Lifting
		Screw Stud.....
1700J	24778	Presser Bar (swing-out) Lifting
		Screw Stud Nut.....
164145	24778	Presser Foot Body.....
164220	24778	" " Chain Cutter Friction Plate.....
164221	24778	Presser Foot Chain Cutter Knife.....
51306E	24778	" " " " "
		Screw.....
164146	24778	Presser Foot Chain-off Finger....
164147	24778	" " Clamping Plate.....
50225J	24778	" " " " Screw...
164149	24778	" " Guide.....
50169J	24778	" " " " Screw.....
164150	24778	Presser Foot with Chain Cutter complete, Nos. 50169J, 50225J, 51306E, 164145, 164146, 164147, 164149, 164220 and 164221.....

No.	Plate	Name
164317	24778	Presser Bar (swing-out) with Presser Foot complete, Nos. 1700J, 164141, 164150 and 164350.....
164175	24778	Thread (looper) Take-up.....
164091	24778	" (looper, right hand) Stripper and Take-up.....
164151	24778	Thread (needle) Controller.....
164179	24778	Throat Plate Guide with 853AL.....

SET OF FITTINGS COMPLETE

No. 164332

FOR

Wash Cloths and Towels

For Three-Thread Purl-on-Edge Stitch

No.	Plate	Name
164322	24779	Feed (back) Dog Section (left).....
164323	24779	" " " " (right).....
1100AL	24779	" " " " " "
		Screw.....
164324	24779	Feed (back) Dog complete, Nos. 1100AL, 164322 and 164323.....
164325	24779	Feed (front) Dog.....
164258	24779	Presser Bar (swing-out).....
164327	24779	" Foot Body.....
164263	24779	" " Clamping Plate.....
50225J	24779	" " " " Screw...
164328	24779	" " Edge Folder.....
164329	24779	" " " " Plate.....
164330	24779	Presser Foot with Edge Folder complete, Nos. 50225J, 164263, 164327, 164328 and 164329.....
164287	24779	Thread (looper) Take-up (left).....
164288	24779	" " " " (right).....
164331	24779	Throat Plate.....
164268	24779	" " Guide with 853AL.....
164332	24779	Set of Fittings complete, Nos. 164258, 164268, 164287, 164288, 164324, 164325, 164330 and 164331.....

Note: When using Set of Fittings complete No. 164332 the following parts which are not included in this Set of Fittings, are necessary, if machine has previously been fitted other than regular (see Set of Fittings No. 164270).

No.	Plate	Name
164026	24779	Knife (movable).....
164055	24779	Looper (right hand).....

SET OF FITTINGS COMPLETE

No. 164344

FOR

Inserting Elastic, 1/8 inch to 3/16 inch and for

Stitching Through Tape 3/16 inch Wide

For Rayon and Light and Medium Weight Sweater Materials

For Three-Thread Purl-on-Edge Stitch

No.	Plate	Name
164337	24780	Guide for elastic and tape.....
51614J	24780	" Nut.....
164338	24780	Presser Foot Body.....
164339	24780	" " Chaining-off Finger....
164340	24780	" " Clamping Plate.....
50225J	24780	" " " " Screw....
164341	24780	" " Guide (adjustable) for stitching through tape 3/16" wide.....
164342	24780	Presser Foot Guide (adjustable) for use when inserting elastic 1/8" to 3/16" wide.....
50169J	24780	Presser Foot Guide (adjustable) Screw.....
164343	24780	Presser Foot complete, Nos. 50169J, 50225J, 164338, 164339, 164340, 164341 and 164342.....
164344	24780	Set of Fittings complete Nos. 51614J, 164337 and 164343.....

Note: When using Set of Fittings complete No. 164344 the following parts which are not included in this Set of Fittings, are necessary, if machine has previously been fitted other than regular (see Set of Fittings No. 164270).

No.	Plate	Name
164011	24780	Feed (back) Dog Section (left).....
164012	24780	" " " " (right).....
1100AL	24780	" " " " " " Screw.....
164013	24780	Feed (back) Dog complete, Nos. 1100AL, 164011 and 164012.....
164019	24780	Feed (front) Dog.....
164026	24780	Knife (movable).....
164055	24780	Looper (right hand).....
164350	24780	Presser Bar (swing-out).....
164175	24780	Thread (looper) Take-up (left).....
164091	24780	" " " " (right).....
164178	24780	Throat Plate.....
164179	24780	" " Guide with 853AL.....

SET OF FITTINGS COMPLETE

No. 164388

FOR

Sweater Materials

For Two-Thread Stitch

For 1/8 inch Bight

No.	Plate	Name
164222	24781	Feed (back) Dog Section (left).....
164223	24781	" " " " (right).....
1100AL	24781	" " " " " " Screw.....
164224	24781	Feed (back) Dog complete, Nos. 1100AL, 164222 and 164223.....
164225	24781	Feed (front) Dog.....
164308	24781	Knife (movable).....
164252	24781	Spreader.....
164381	24781	Thread (needle) Controller.....
164227	24781	Throat Plate.....
164388	24781	Set of Fittings complete, Nos. 164224, 164225, 164227, 164252, 164308 and 164381.....

Note: When using Set of Fittings complete No. 164388 the following parts which are not included in this Set of Fittings, are necessary, if machine has previously been fitted other than regular (see Set of Fittings No. 164270).

No.	Plate	Name
164350	24781	Presser Bar (swing-out).....
164145	24781	" Foot Body.....
164220	24781	" " Chain Cutter Friction Plate.....
164221	24781	Presser Foot Chain Cutter Knife.....
51306E	24781	" " " " " " Screw.....
164146	24781	Presser Foot Chaining-off Finger....
164147	24781	" " Clamping Plate.....
50225J	24781	" " " " " " Screw....
164149	24781	" " Guide.....
50169J	24781	" " " " " " Screw.....
164150	24781	Presser Foot with Chain Cutter complete, Nos. 50169J, 50225J, 51306E, 164145, 164146, 164147, 164149, 164220 and 164221.....
164317	24781	Presser Bar (swing-out) with Presser Foot complete, Nos. 1700J, 164141, 164150 and 164350.....
164091	24781	Thread (looper) Stripper and Take-up
164175	24781	" " Take-up.....
164179	24781	Throat Plate Guide with 853AL.....

SET OF FITTINGS COMPLETE

No. 164389

FOR

Foundation Garments

For Two-Thread Stitch

No.	Plate	Name
164322	24782	Feed (back) Dog Section (left).....
164323	24782	" " " " (right).....
1100AL	24782	" " " " ".....
		Screw.....
164324	24782	Feed (back) Dog complete, Nos. 1100AL, 164322 and 164323.....
164325	24782	Feed (front) Dog.....
164258	24782	Presser Bar (swing-out).....
164259	24782	" Foot Body.....
164260	24782	" Chain Cutter Friction Plate.....
164261	24782	Presser Foot Chain Cutter Knife.....
51306E	24782	" " " " ".....
		Screw.....
164262	24782	Presser Foot Chaining-off Finger....
164263	24782	" " Clamping Plate.....
50225J	24782	" " " " Screw....
164264	24782	Presser Foot complete, Nos. 50225J, 51306E, 164259, 164260, 164261, 164262 and 164263.....
164252	24782	Spreader.....
164290	24782	Throat Plate.....
164268	24782	" " Guide with 853AL.....
164389	24782	Set of Fittings complete, Nos. 164252, 164258, 164264, 164268, 164290, 164324 and 164325.....

Note: When using Set of Fittings complete No. 164389 the following parts which are not included in this Set of Fittings, are necessary, if machine has previously been fitted other than regular (see Set of Fittings No. 164270).

No.	Plate	Name
164026	24782	Knife (movable).....
164091	24782	Thread (looper) Stripper and Take-up
164175	24782	" " Take-up.....
164151	24782	" (needle) Controller.....

SET OF FITTINGS COMPLETE

No. 164390

FOR

Foundation Garments

For Three-Thread Stitch

No.	Plate	Name
164322	24783	Feed (back) Dog Section (left).....
164323	24783	" " " " (right).....
1100AL	24783	" " " " ".....
		Screw.....
164324	24783	Feed (back) Dog complete, Nos. 1100AL, 164322 and 164323.....
164325	24783	Feed (front) Dog.....
164258	24783	Presser Bar (swing-out).....
164259	24783	" Foot Body.....
164260	24783	" Chain Cutter Friction Plate.....
164261	24783	Presser Foot Chain Cutter Knife.....
51306E	24783	" " " " ".....
		Screw.....
164262	24783	Presser Foot Chaining-off Finger....
164263	24783	" " Clamping Plate.....
50225J	24783	" " " " Screw....
164264	24783	Presser Foot with Chain Cutter complete, Nos. 50225J, 51306E, 164259, 164260, 164261, 164262 and 164263.....
164290	24783	Throat Plate.....
164268	24783	" " Guide with 853AL.....
164390	24783	Set of Fittings complete, Nos. 164258, 164264, 164268, 164290, 164324 and 164325.....

Note: When using Set of Fittings complete No. 164390 the following parts which are not included in this Set of Fittings, are necessary, if machine has previously been fitted other than regular (see Set of Fittings No. 164270).

No.	Plate	Name
164026	24783	Knife (movable).....
164055	24783	Looper (right hand).....
164175	24783	Thread (looper) Take-up.....
164091	24783	" (looper, right hand) Stripper and Take-up.....
164151	24783	Thread (needle) Controller.....

SET OF FITTINGS COMPLETE

No. 164395

FOR

Trimming and Folding the Edge and Overedging Curtains

For Two-Thread Stitch

No.	Plate	Name
164309	24784	Guide (swing-out).....
164297	24784	" " Arm.....
164298	24784	" " " Holder.....
50267R	24784	" " " " Screw
		(2).....
164299	24784	Guide (swing-out) Extension.....
228J	24784	" " " Screw...
1425J	24784	" " Hinge Screw.....
42436	24784	" " " Washer
1443J	24784	" " Screw (2).....
164311	24784	Guide (swing-out) with Arm and Hold- er complete, Nos. 228J, 1425J, 42436, 164297, 164298, 164299, 164309 and two 1443J.....
164145	24784	Presser Foot Body.....
164220	24784	" " Chain Cutter Friction Plate.....
164221	24784	Presser Foot Chain Cutter Knife.....
51306E	24784	" " " " " "
		Screw.....
164392	24784	Presser Foot Chaining-off Finger....
164147	24784	" " Clamping Plate.....
50225J	24784	" " " " Screw...
164149	24784	" " Guide.....
50169J	24784	" " " Screw.....
164393	24784	Presser Foot with Chain Cutter com- plete, Nos. 50169J, 50225J, 51306E, 164145, 164147, 164149, 164220, 164221 and 164392.....
164252	24784	Spreader.....
164404	24784	Tension (looper thread) Spring.....
164394	24784	Throat Plate with 164396.....
164396	24784	" " Thread Finger.....
164395	24784	Set of Fittings complete, Nos. 164252, 164311, 164393, 164394, 164404 and two 50267R.....

Note: When using Set of Fittings complete No. 164395 the following parts which are not included in this Set of Fittings, are necessary, if machine has previously been fitted other than regular (see Set of Fittings No. 164270).

No.	Plate	Name
164011	24784	Feed (back) Dog Section (left).....
164012	24784	" " " " (right).....
1100AL	24784	" " " " "
		Screw.....
164013	24784	Feed (back) Dog complete, Nos. 1100AL, 164011 and 164012.....
164019	24784	Feed (front) Dog.....
164026	24784	Knife (movable).....
164350	24784	Presser Bar (swing-out).....
164091	24784	Thread (looper) Stripper and Take-up
164175	24784	" " Take-up.....
164151	24784	" (needle) Controller.....
164179	24784	Throat Plate Guide with 853AL.....

SET OF FITTINGS COMPLETE

No. 164431

FOR

Plastic Materials

For Three-Thread Stitch

No.	Plate	Name
164279	24785	Feed Dog Section (left).....
164280	24785	" " " (right).....
1100AL	24785	" " " " Screw.....
164281	24785	Feed Dog complete, Nos. 1100AL, 164279 and 164280.....
164258	24785	Presser Bar (swing-out).....
164282	24785	" Foot Chaining-off Finger....
164263	24785	" " Clamping Plate.....
50225J	24785	" " " " Screw...
164429	24785	" " Plate.....
140180J	24785	" " Screw.....
164430	24785	Presser Foot complete, Nos. 50225J, 164263, 164282 and 164429.....
164290	24785	Throat Plate.....
164268	24785	" " Guide with 853AL.....
164431	24785	Set of Fittings complete, Nos. 140180J, 164258, 164268, 164281, 164290 and 164430.....

Note: When using Set of Fittings complete No. 164431 the following parts which are not included in this Set of Fittings, are necessary, if machine has previously been fitted other than regular (see Set of Fittings No. 164270).

No.	Plate	Name
164026	24785	Knife (movable).....
164055	24785	Looper (right hand).....
164175	24785	Thread (looper) Take-up.....
164091	24785	" (looper, right hand) Stripper and Take-up.....
164151	24785	Thread (needle) Controller.....

SET OF FITTINGS COMPLETE

No. 164435

FOR

For Joining Lace to Undergarments

For Two-Thread Stitch

No.	Plate	Name
164279	24786	Feed Dog Section (left).....
164280	24786	" " " (right).....
1100AL	24786	" " " " Screw.....
164281	24786	Feed Dog complete, Nos. 1100AL, 164279 and 164280.....
164309	24786	Guide (swing-out).....
164297	24786	" " " Arm.....
164298	24786	" " " Holder.....
50267R	24786	" " " " Screw (2).....
1425J	24786	Guide (swing-out) Hinge Screw.....
42436	24786	" " " " Washer
1443J	24786	" " " Screw (2).....
164432	24786	" " " Separating Blade..
164436	24786	" " " " Holder.....
228J	24786	Guide (swing-out) Separating Blade Holder Screw.....
164433	24786	Guide (swing-out) with Arm, Holder and Separating Blade complete, Nos. 228J, 1425J, 42436, 164297, 164298, 164309, 164432, 164436 and two 1443J.....
164258	24786	Presser Bar (swing-out).....
164259	24786	" Foot Body.....
164260	24786	" " Chain Cutter Friction Plate.....
164261	24786	Presser Foot Chain Cutter Knife....
51306E	24786	" " " " " Screw.....
164262	24786	Presser Foot Chaining-off Finger....
164263	24786	" " Clamping Plate.....
50225J	24786	" " " " Screw...
164264	24786	Presser Foot with Chain Cutter com- plete, Nos. 50225J, 51306E, 164259, 164260, 164261, 164262 and 164236.....
164252	24786	Spreader.....
164434	24786	Throat Plate.....
164268	24786	" " Guide with 853AL.....
164435	24786	Set of Fittings complete, Nos. 164252, 164258, 164264, 164268, 164281, 164433, 164434 and two 50267R.....

Note: When using Set of Fittings complete No. 164435 the following parts which are not included in this Set of Fittings, are necessary, if machine has previously been fitted other than regular (see Set of Fittings No. 164270).

No.	Plate	Name
164026	24786	Knife (movable).....
164091	24786	Thread (looper) Stripper and Take-up
164175	24786	" " Take-up.....

SET OF FITTINGS COMPLETE

No. 164437

FOR

Stretching and Inserting Elastic, 1/8 inch to 3/16 inch and for

Stitching Through Tape 3/16 inch Wide

For Rayon and Light and Medium Weight Sweater Materials

For Three-Thread Purl-on-Edge Stitch

No.	Plate	Name
160591	24787	Elastic Guide (movable).....
160592	24787	" " (stationary).....
160593	24787	" " Bracket.....
337J	24787	" " Screw (4).....
51614J	24787	" Tension Guide Nut.....
160594	24787	" " Plate.....
10248	24787	" " Position Pin..
120565	24787	" " Spacing Washer
1560C	24787	" " Tension Regu-
		lating Thumb Nut.....
916C	24787	Elastic Tension Plate Tension Screw
		Stud.....
44209	----	Elastic Tension Plate Tension Screw
		Stud 916C with 1560C.....
13710	24787	Elastic Tension Plate Tension Spring
160595	24787	Elastic Tension Guide complete, Nos.
		10248, 13710, 44209, 120565,
		160591, 160592, 160593, 160594
		and four 337J.....
164338	24787	Presser Foot Body.....
164339	24787	" " Chaining-off Finger...
164340	24787	" " Clamping Plate.....
50225J	24787	" " " " Screw...
164341	24787	" " Guide (adjustable) for
		stitching through tape 3/16"
		wide.....
164342	24787	Presser Foot Guide (adjustable) for
		use when inserting elastic 1/8"
		to 3/16" wide.....
50169J	24787	Presser Foot Guide (adjustable)
		Screw.....
164343	24787	Presser Foot complete, Nos. 50169J,
		50225J, 164338, 164339, 164340,
		164341 and 164342.....
164437	24787	Set of Fittings complete, Nos.
		51614J, 160595 and 164343.....

Note: When using Set of Fittings complete No. 164437 the following parts which are not included in this Set of Fittings, are necessary, if machine has previously been fitted other than regular (see Set of Fittings No. 164270).

No.	Plate	Name
164011	24787	Feed (back) Dog Section (left).....
164012	24787	" " " " (right).....
1100AL	24787	" " " " " "
		Screw.....
164013	24787	Feed (back) Dog complete, Nos. 1100AL, 164011 and 164012.....
164019	24787	Feed (front) Dog.....
164026	24787	Knife (movable).....
164055	24787	Looper (right hand).....
164350	24787	Presser Bar (swing-out).....
164175	24787	Thread (looper) Take-up (left).....
164091	24787	" " " " (right).....
164178	24787	Throat Plate.....
164179	24787	" " Guide with 853AL.....

SET OF FITTINGS COMPLETE

No. 164451

FOR

Seaming Semi-Girdles

For Three-Thread Loose Purl Stitch

For 1/8 inch Bight

No.	Plate	Name
164254	24788	Feed (back) Dog Section (left).....
164255	24788	" " " " (right).....
1100AL	24788	" " " " " "
		Screw.....
164256	24788	Feed (back) Dog complete, Nos. 1100AL, 164254 and 164255.....
164257	24788	Feed (front) Dog.....
164258	24788	Presser Bar (swing-out).....
164259	24788	" Foot Body.....
164260	24788	" " Chain Cutter Friction Plate.....
164261	24788	Presser Foot Chain Cutter Knife.....
51306E	24788	" " " " " "
		Screw.....
164262	24788	Presser Foot Chaining-off Finger....
164263	24788	" " Clamping Plate.....
50225J	24788	" " " " Screw...
164264	24788	Presser Foot with Chain Cutter com- plete, Nos. 50225J, 51306E, 164259, 164260, 164261, 164262 and 164263.....
164287	24788	Thread (looper) Take-up (left).....
164288	24788	" " " " (right).....
164381	24788	" (needle) Controller.....
164290	24788	Throat Plate.....
164268	24788	" " Guide with 853AL.....
164451	24788	Set of Fittings complete, Nos. 164256, 164257, 164258, 164264, 164268, 164287, 164288, 164290 and 164381.....

Note: When using Set of Fittings complete No. 164451 the following parts which are not included in this Set of Fittings, are necessary, if machine has previously been fitted other than regular (see Set of Fittings No. 164270).

No.	Plate	Name
164026	24788	Knife (movable).....
164055	24788	Looper (right hand).....

ACCESSORIES

No.	Plate	Name
164203	24762	Feed Eccentric Extractor (not regularly furnished).....
164459	24762	Gauge.....
160577	24762	Oil Container (15 ozs.).....
120344	24762	Oiler (copper plated) with 120345...
120345	24762	" Spout, 4 1/2 in. long.....
164198	24762	Presser Bar Lifting Chain Spring (under table).....
26026	24762	Screw Driver.....
164196	24762	Threader (6).....
164204	24762	Tweezers.....
164197	24762	Wrench (socket).....
8908	24762	" (flat).....

BELT GUARD (Adjustable)

No.	Plate	Name
164183	24763	Belt Guard.....
164199	24763	" " Bracket (back).....
164200	24763	" " " (front).....
51326J	24763	" " Screw (2).....
164201	24763	Belt Guard (adjustable) complete, Nos. 164183, 164199, 164200 and two each 51326J and wood screws 3/4 in. No. 7 F.H.....

CHIP CHUTE

No.	Plate	Name
168198	24763	Chip Chute with four wood screws 3/8 in. No. 6 R.H. blacked.....

FOOT LIFTER PARTS

No.	Plate	Name
6439	24763	Chain, 36 in. to 45 in. with 56864 and 56865.....
Note: When ordering No. 6439, give length required.		
4879	24763	Chain Connecting Link.....
56864	24763	" Hook (large).....
56865	24763	" " (small).....
4881	24763	Treadle.....
4882	24763	" Shaft.....
4883	-----	" Spring.....
4884	24763	" Stand.....
4885	24763	Treadle complete, Nos. 4879, 4881, 4882, 4883, 4884 and two wood screws 1 in. No. 16 F.H.....

MACHINE BASE

No.	Plate	Name
164184	24763	Machine Base with 50608R, 139017 and two each wood screws 3/4 in. No. 8 R.H. and 1 1/4 in. No. 6 F.H..
50608R	24763	Machine Base Plug Screw.....
139017	24763	" " " " Washer.....
164188	24763	" Cushion (large) (2).....
164189	24763	" " (small) (2).....
164190	24763	" Pad (felt).....
140418E	24755	" Screw Stud (back).....
657E	24755	" " (front).....

THREAD UNWINDER No. 151031

FOR

THREE SPOOLS

No.	Plate	Name
151023	24764	Spool Rest with 858AL.....
150203	24764	" " Cushion (felt) (3).....
858AL	24764	" " Hub Set Screw.....
151024	24764	" " Rod.....
1122C	24764	" " " Set Screw (2).....

THREAD UNWINDER

No.	Plate	Name
151025	24764	Spool Rest Stand with two 1122C and three wood screws 1 in. No. 12 F.H.....
151026	24764	Thread Guide (lower).....
50311C	24764	" " " Holder Set Screw.....
151027	24764	Thread Guide (lower) Support with 50311C.....
151028	24764	Thread Guide (upper) (2).....
151029	24764	" " " Holder with four 453AL.....
151030	24764	Thread Guide Rod.....
453AL	24764	" " " Set Screw.....
453AL	24764	" " Set Screw (3).....
151031	24764	Thread Unwinder complete, Nos. 151023, 151024, 151025, 151026, 151027, 151029, 151030, two 151028 and three 150203.....

SINGER Needles should be used
in SINGER Machines.
These Needles and their Containers
are marked with the
Company's Trade Mark "SIMANCO. **" 1

Needles in Containers marked
"FOR SINGER MACHINES"
are NOT **SINGER** made needles. 2

24752 - 1/2

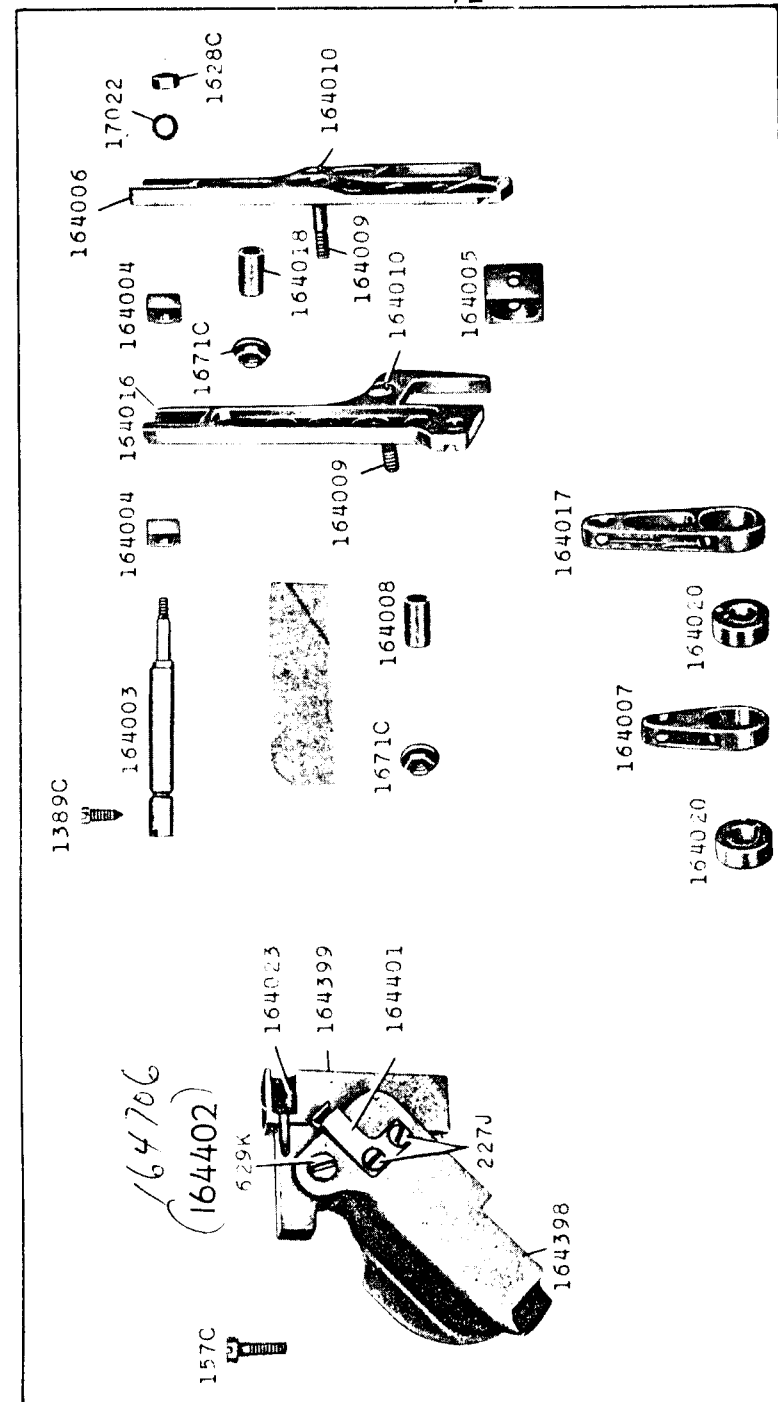

24755 - 1/3

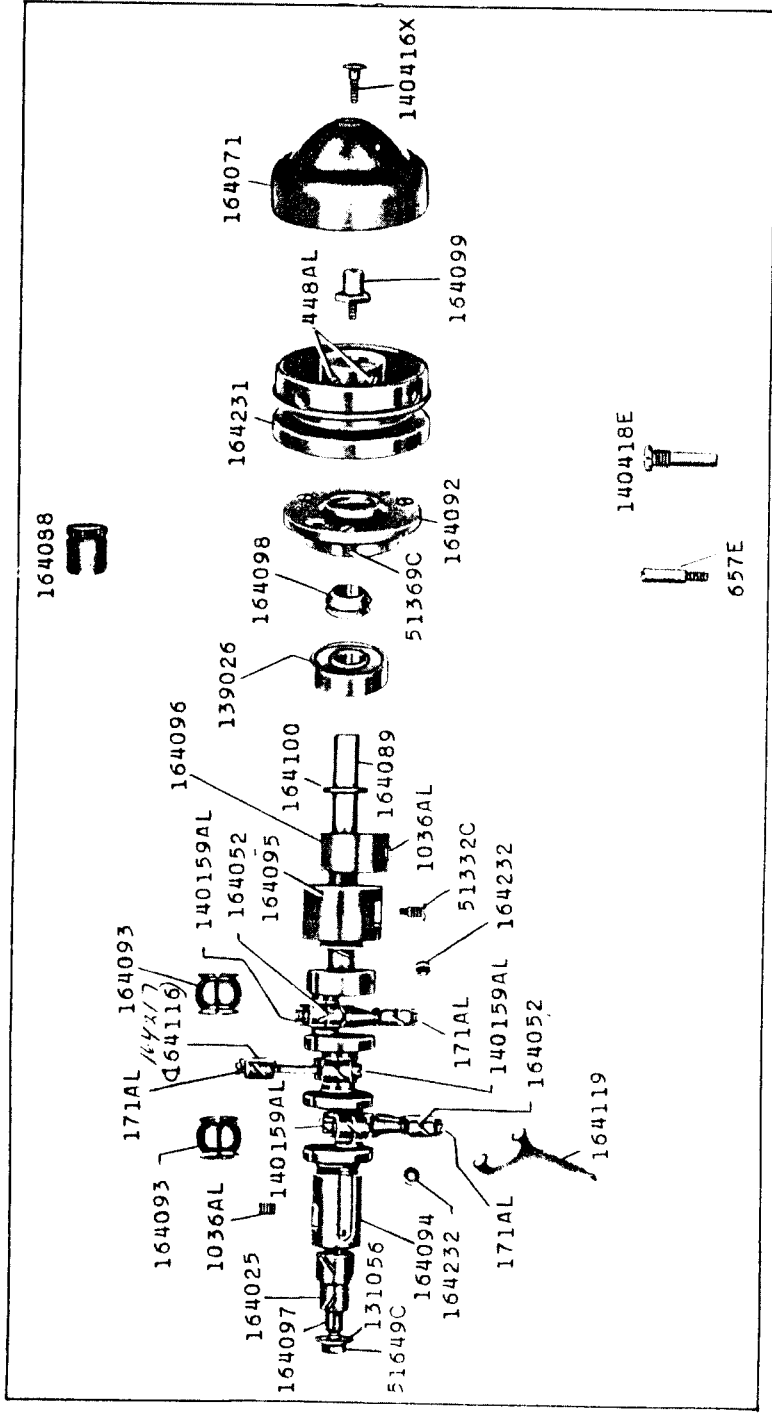

24756 - 1/3

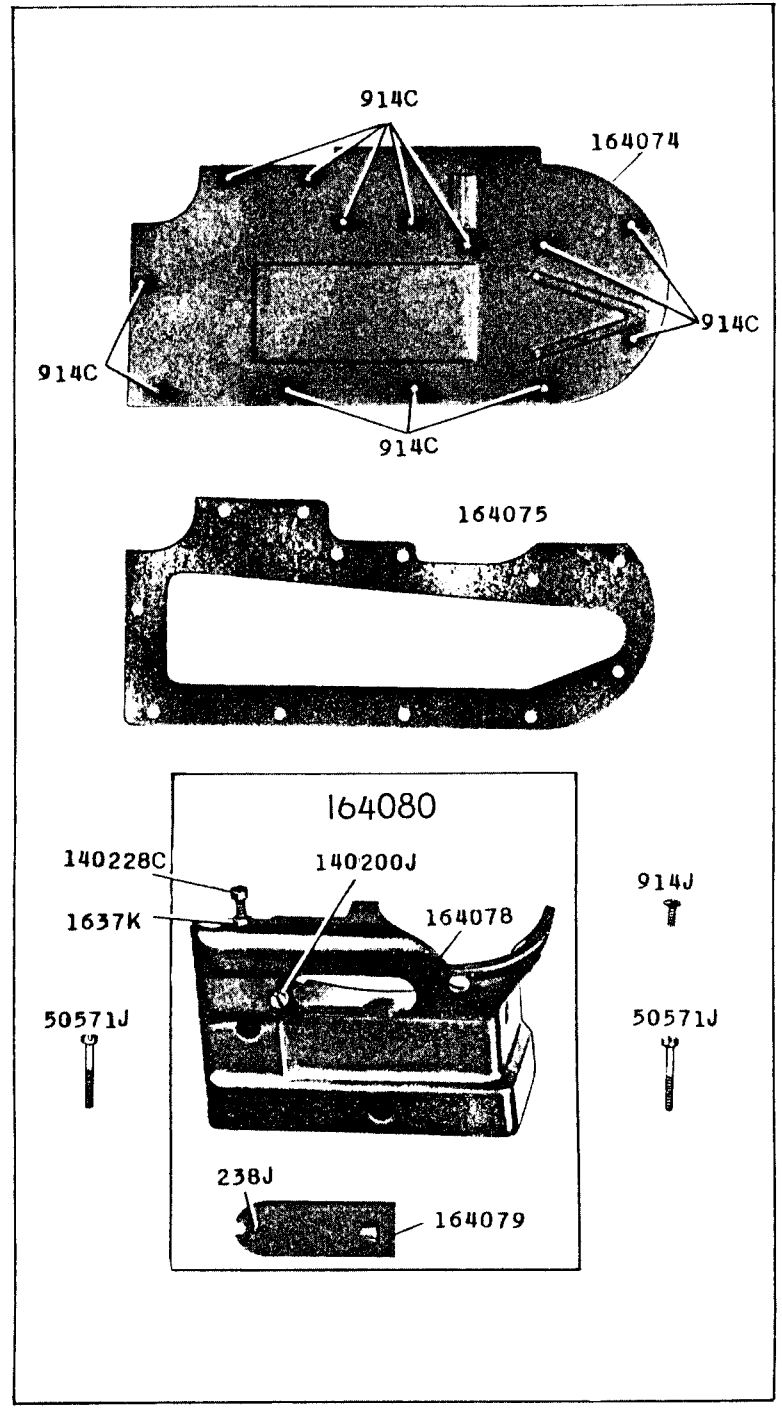

24759 - 1/3

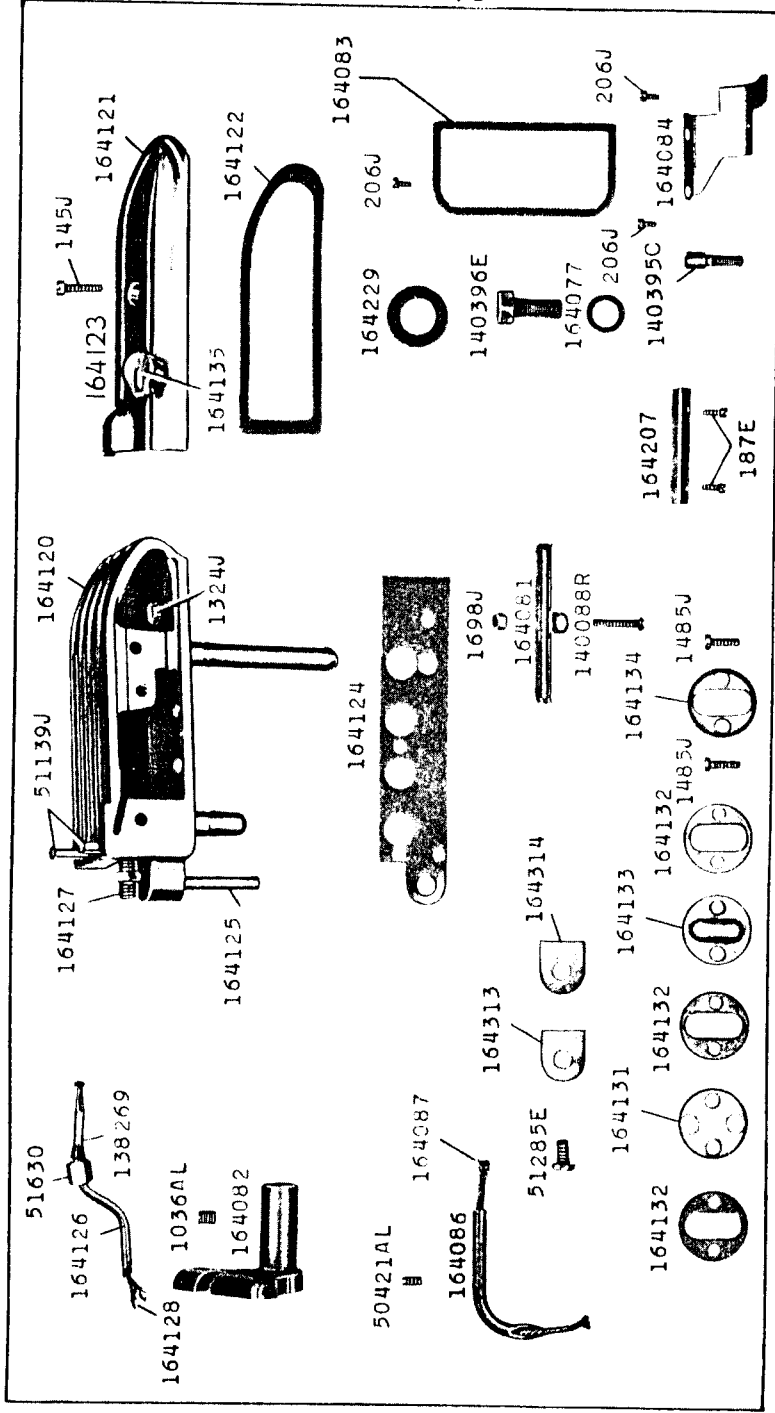

24761 - 2/3

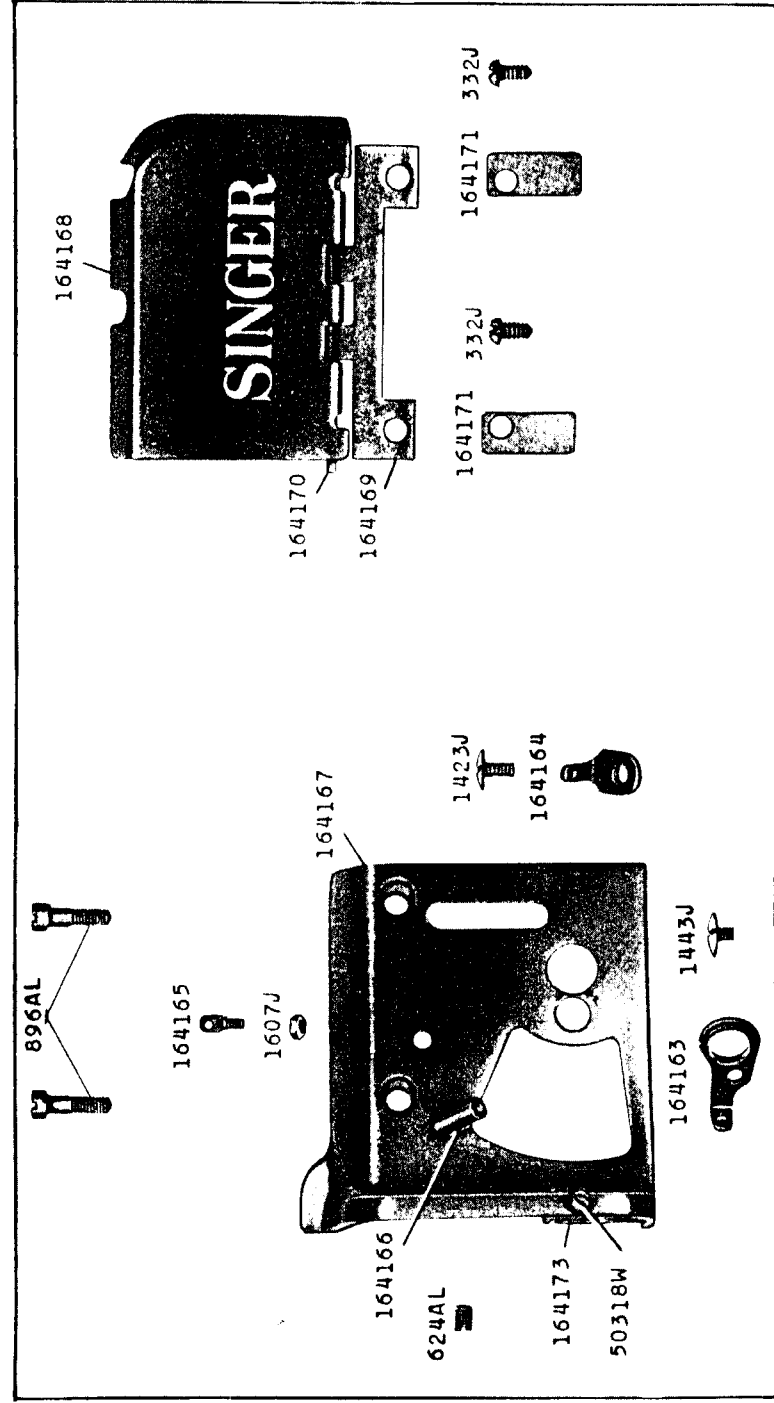

24762 - 1/2

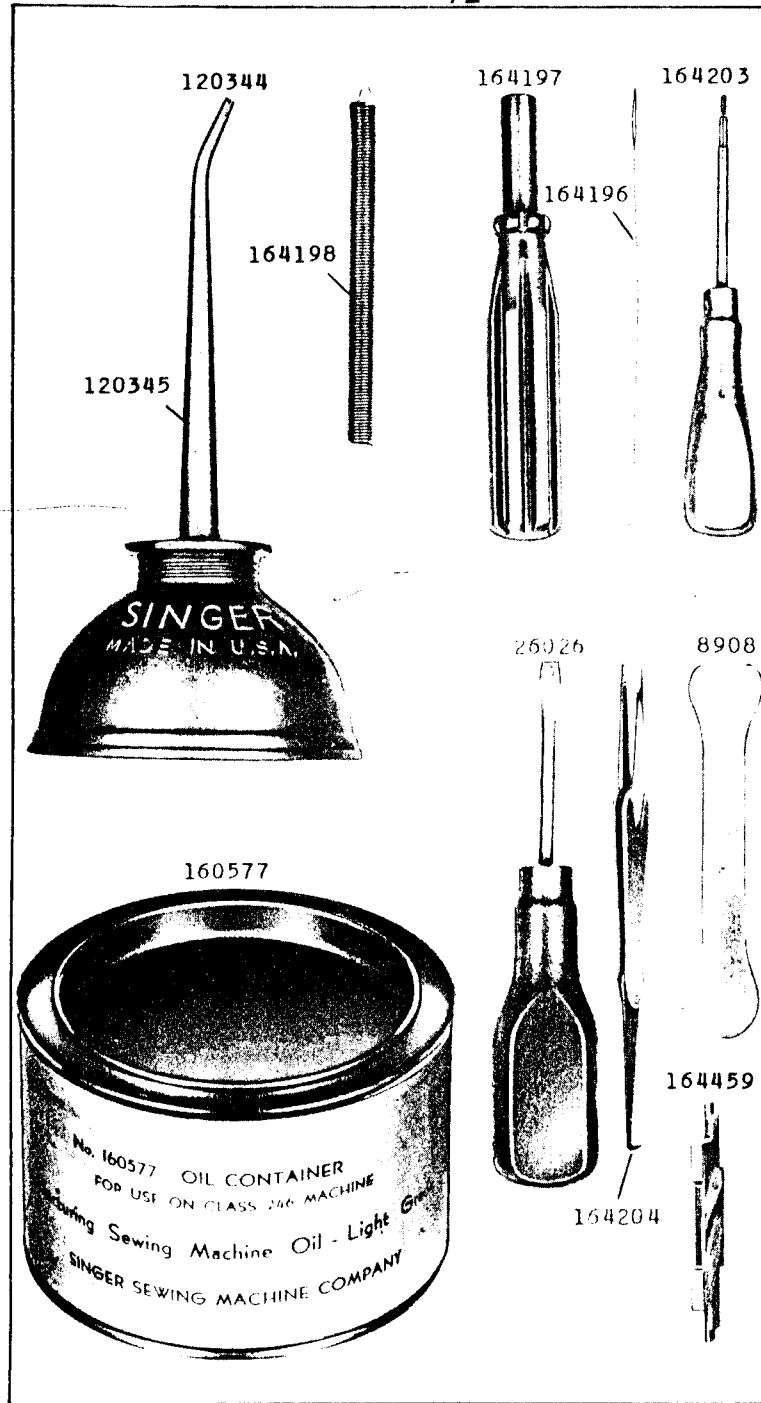

24763 - 1/4

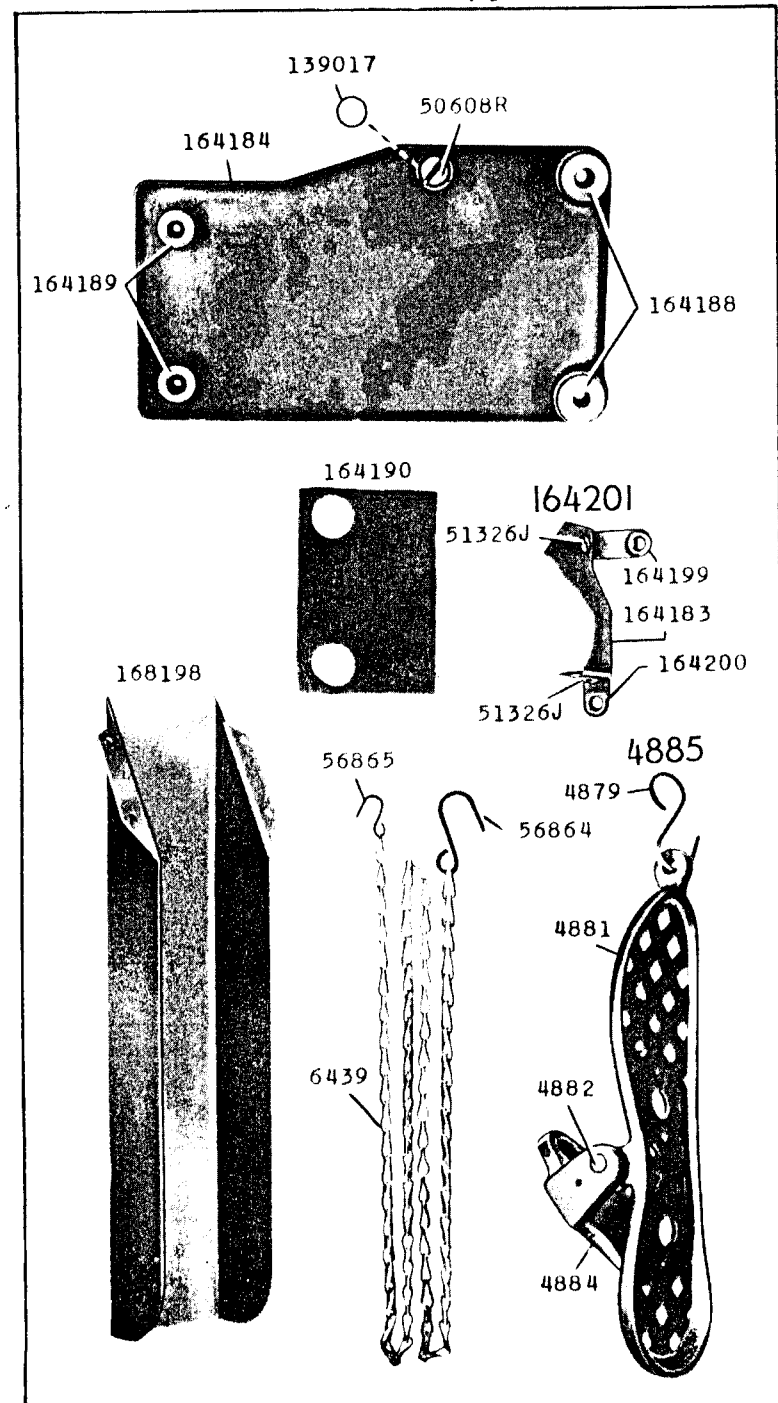

24764 - 1/6

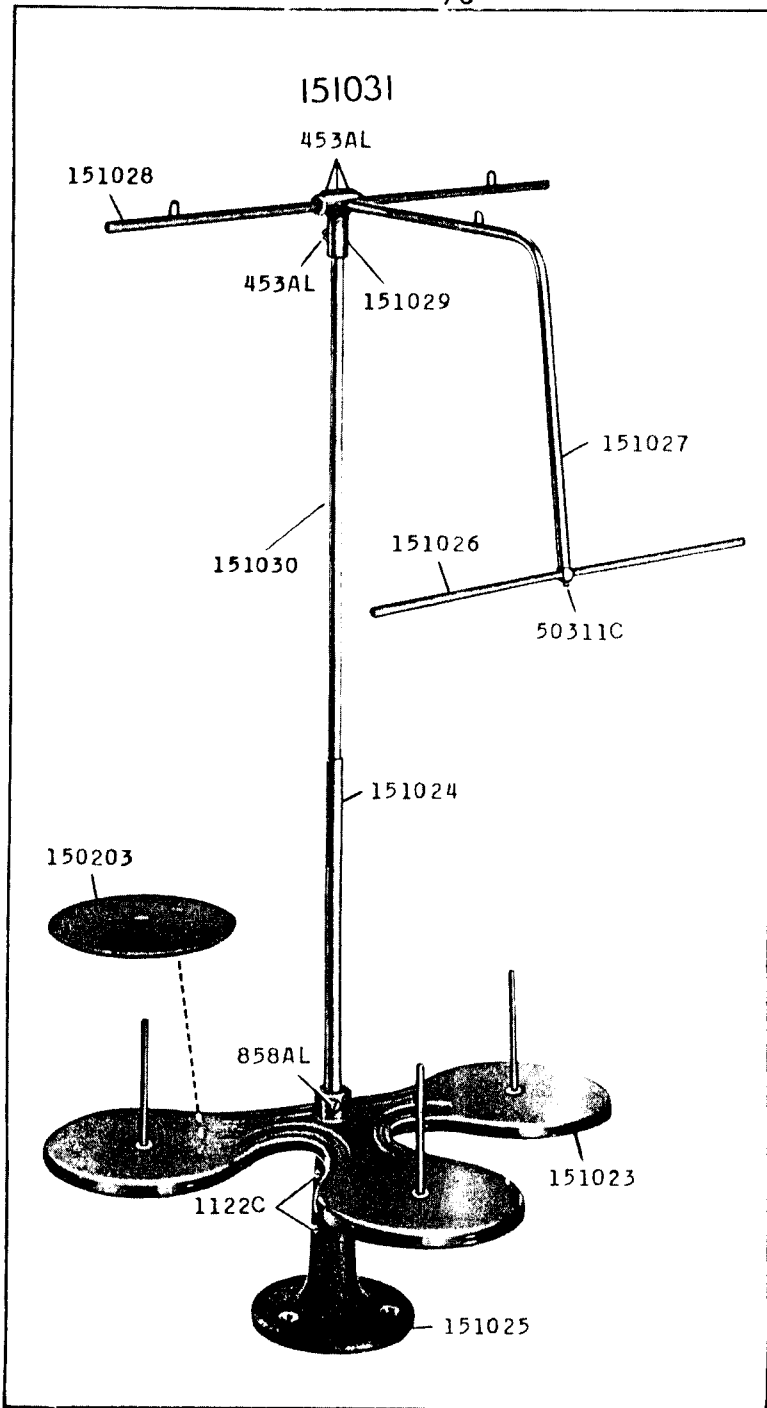

24767 - 1/2

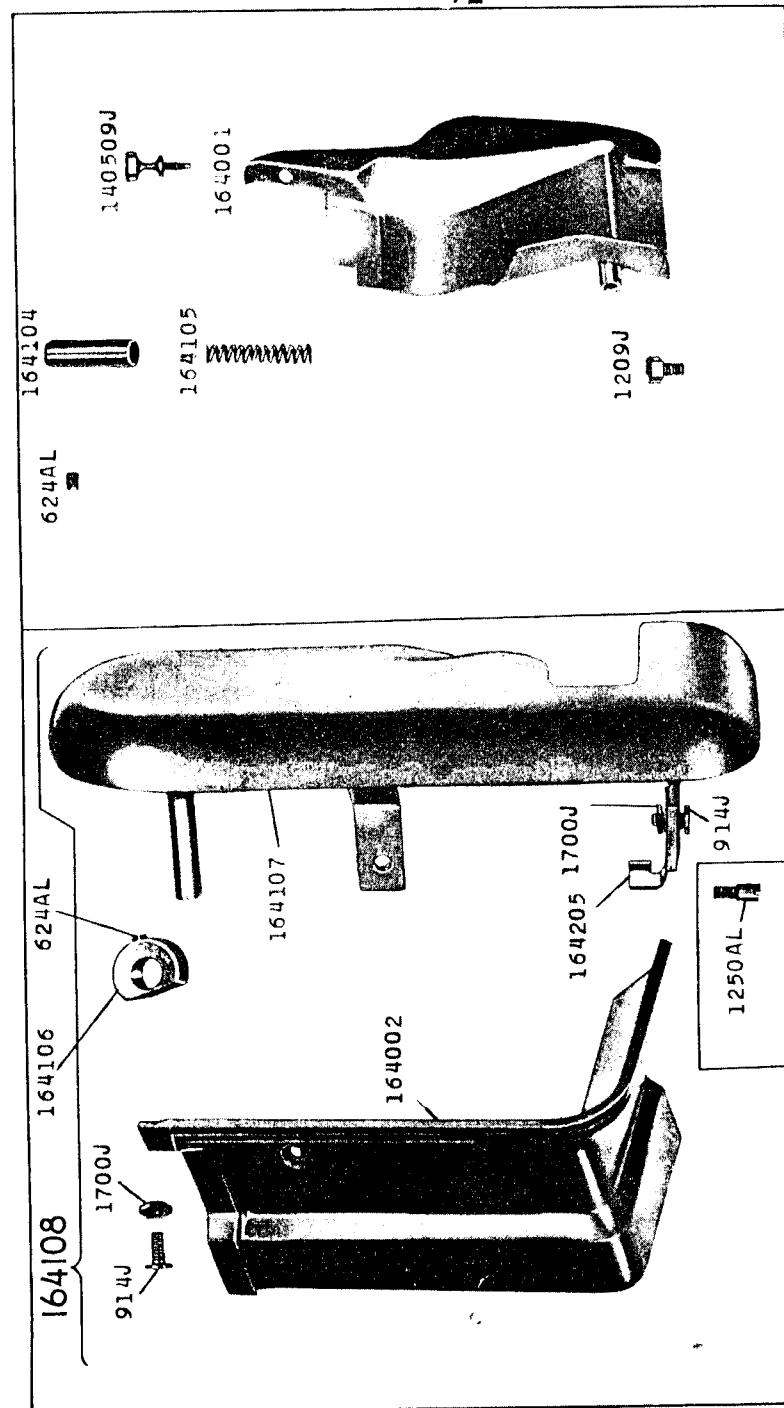

24768 - 1/2

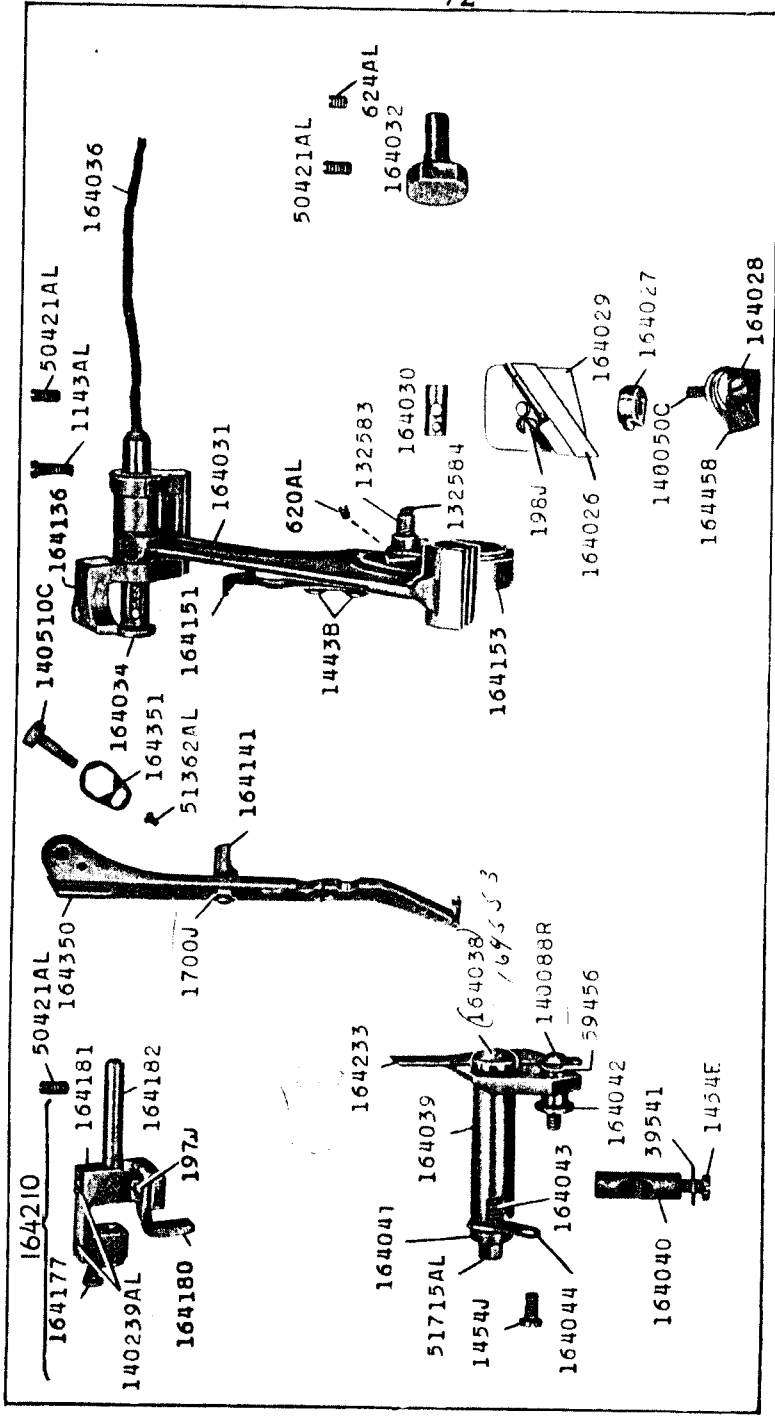

24769 - 1/2

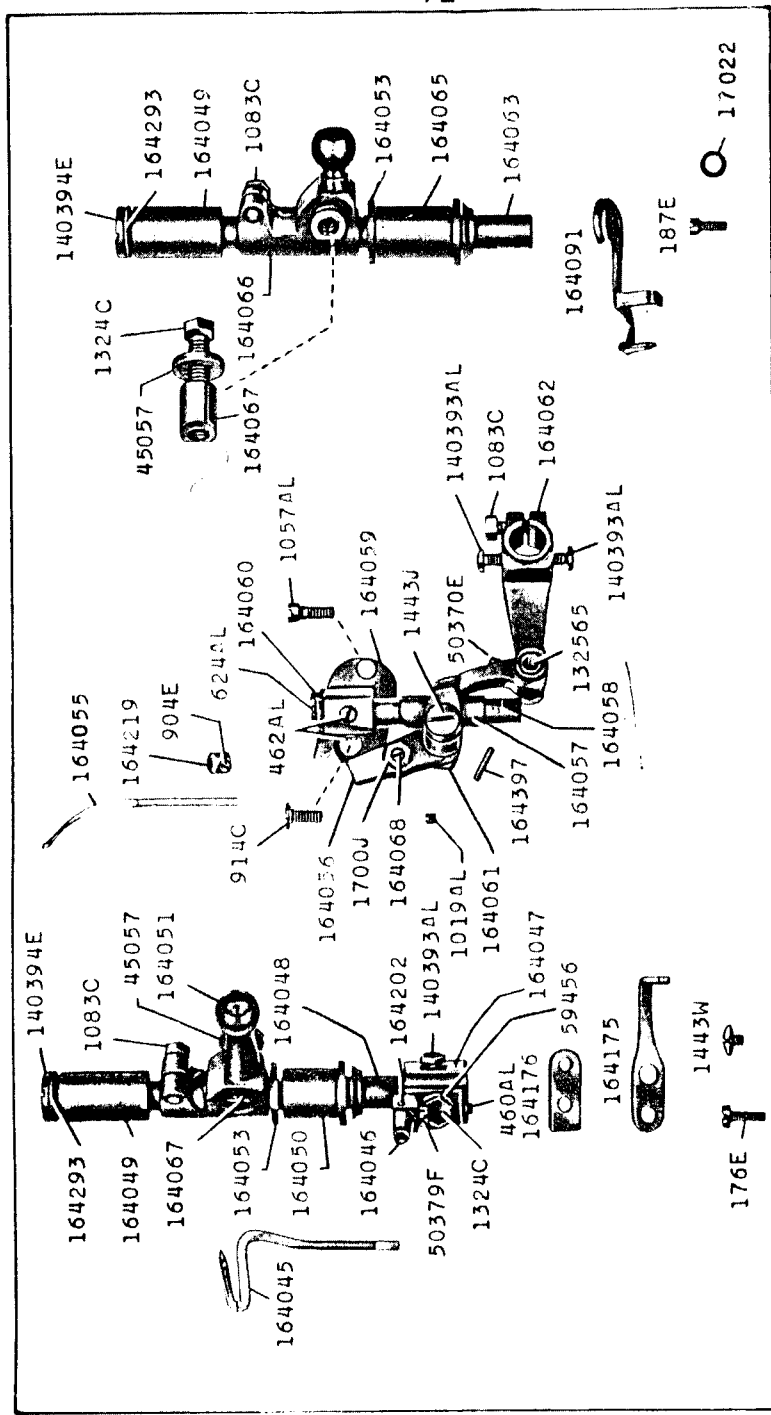

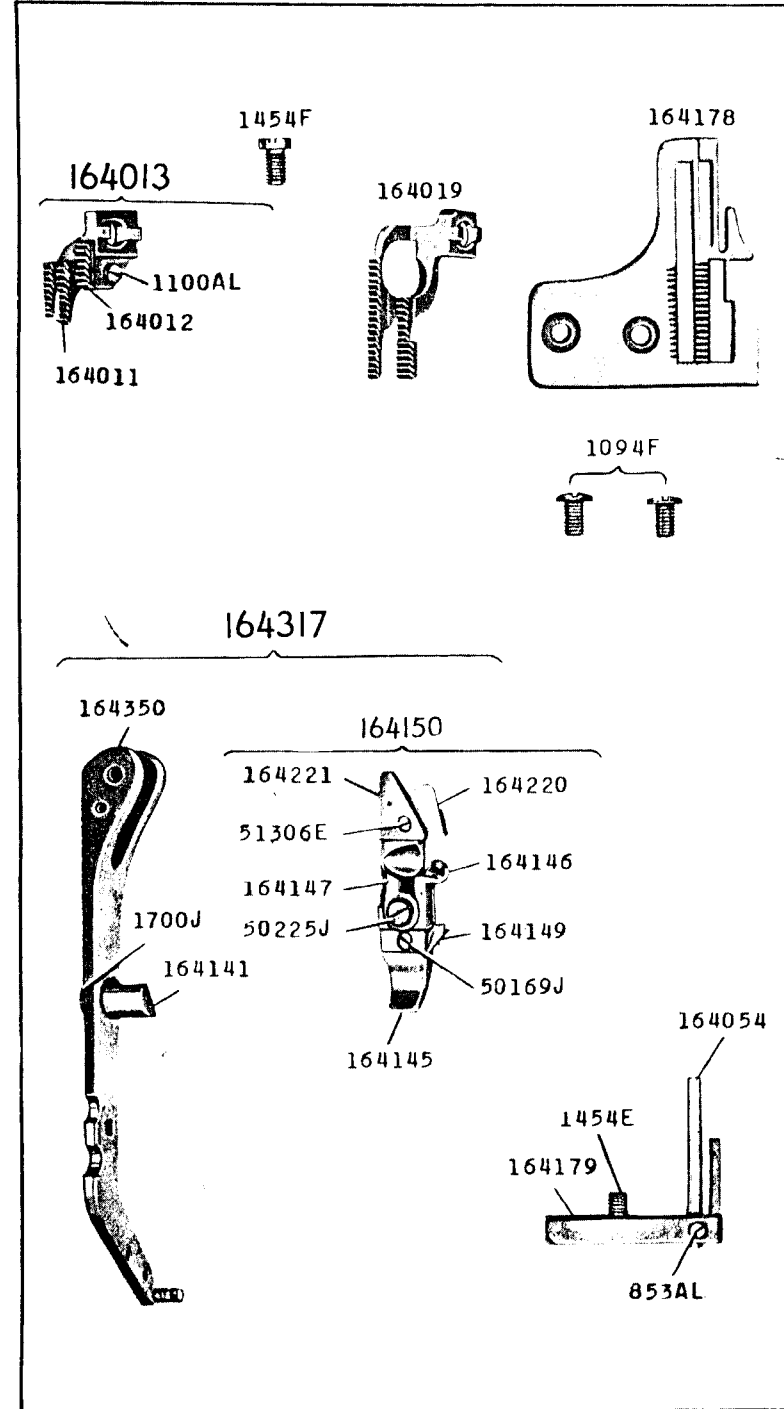
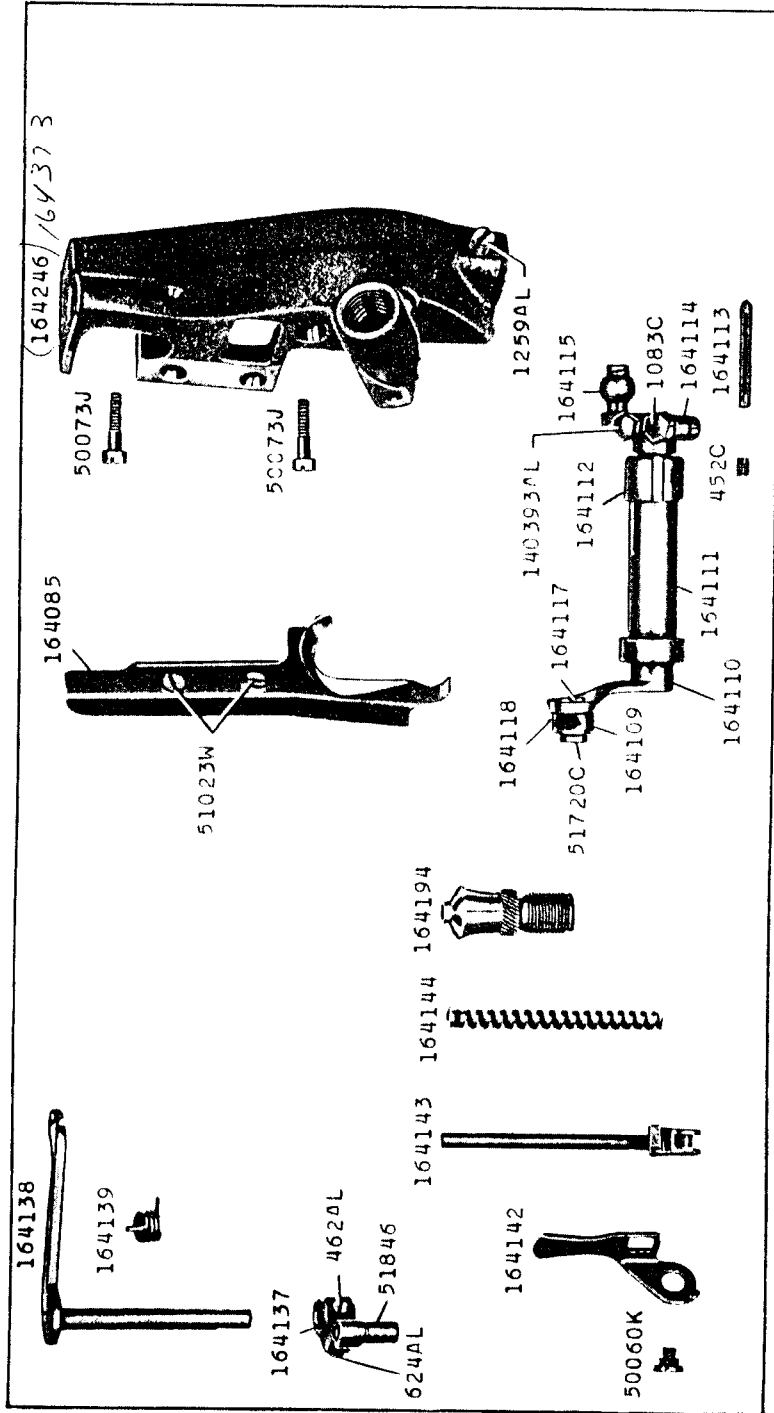

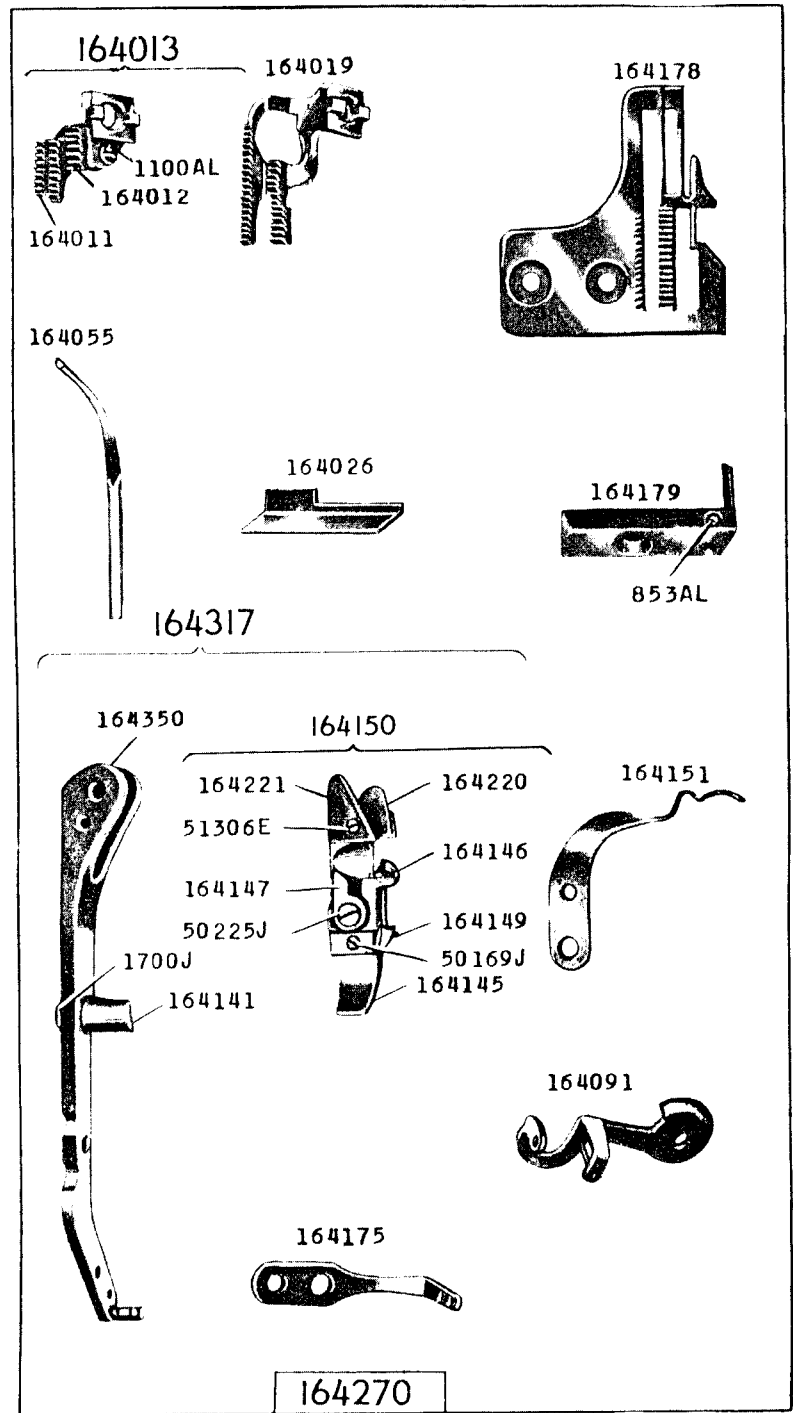
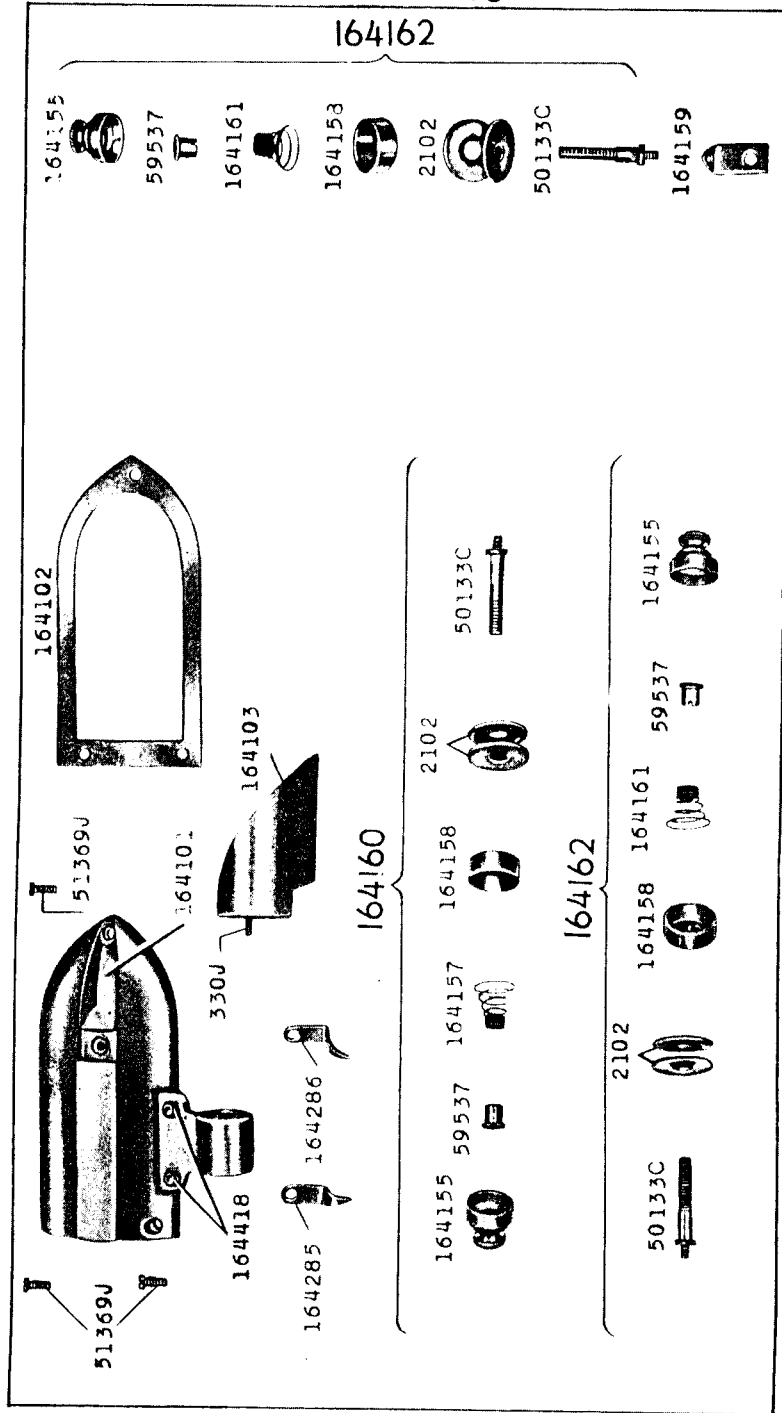

24774 - 2/3

24775 - 2/3

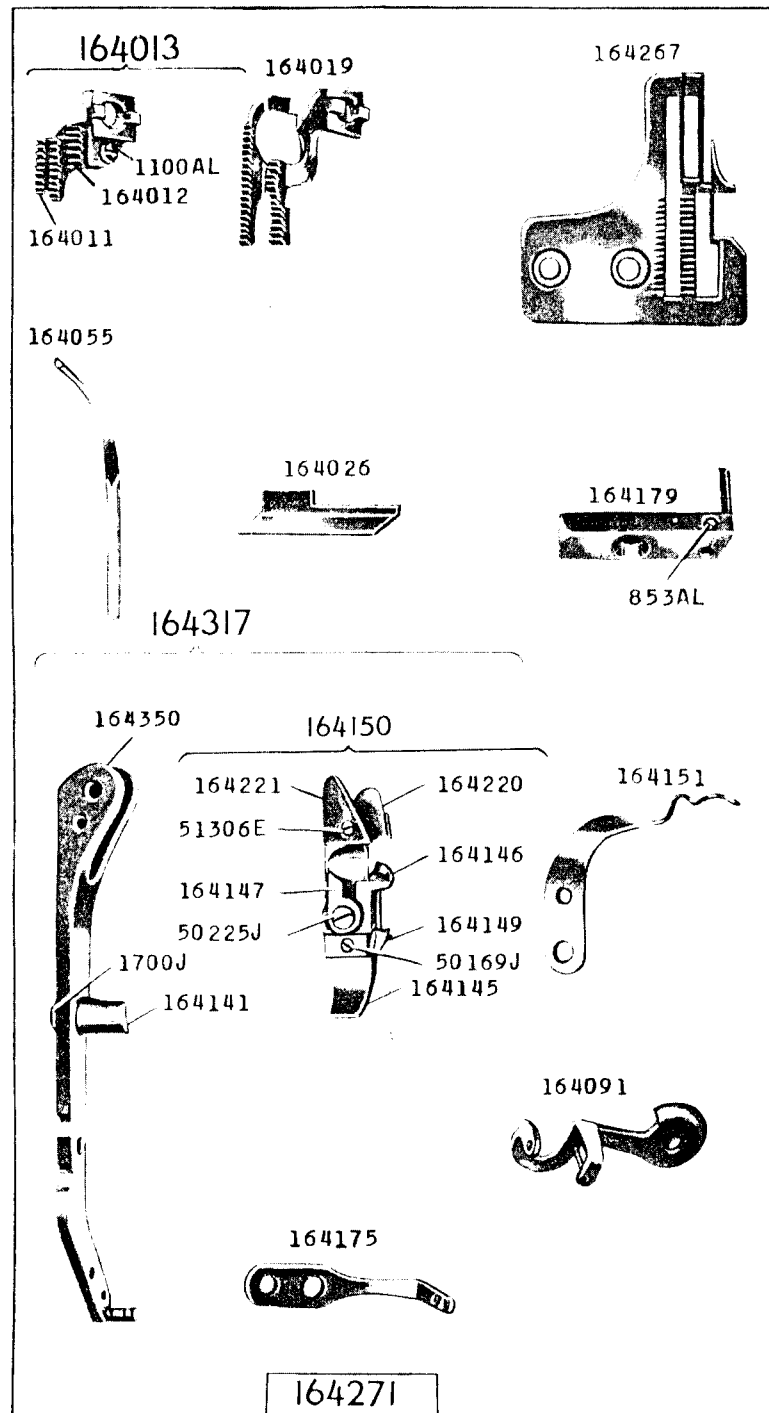
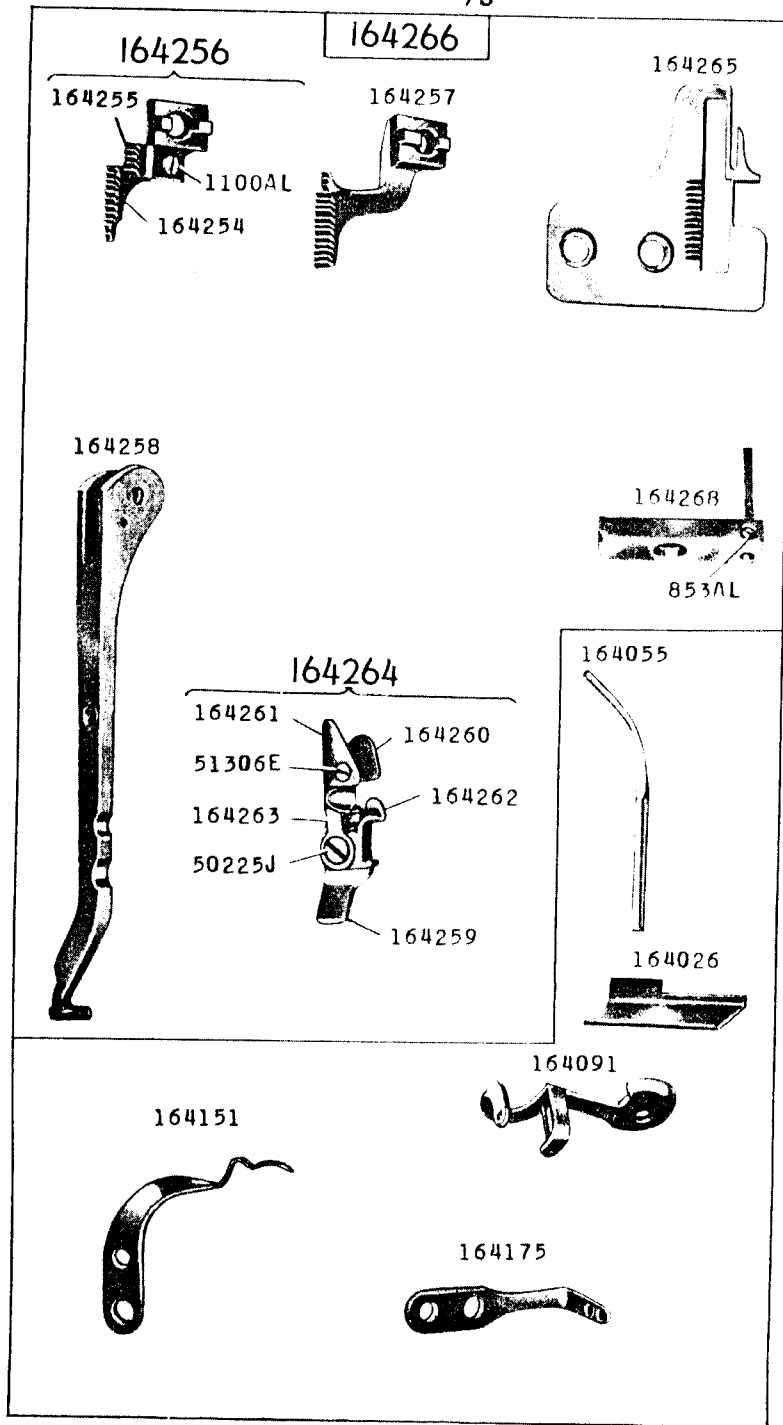

24776 - 2/3

164272

164224

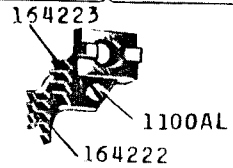

164225



164226

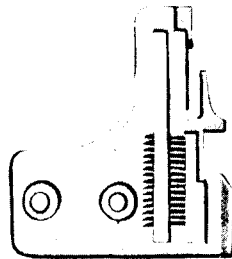

164308



164317

164350



164150

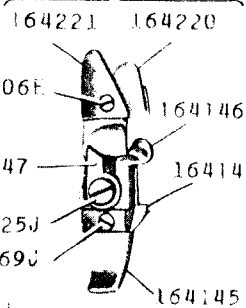

164179

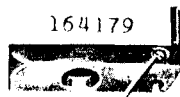

853AL



164151

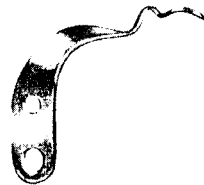

164175



164091



24777 - 2/3

164273

164224

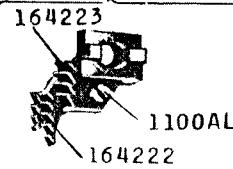

164225

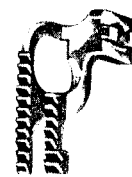

164227

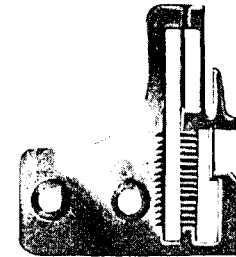

164308



164317

164350



164150

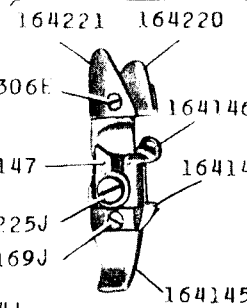

164179

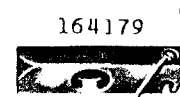

853AL



164151

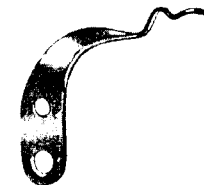

164175



164091



24778 - 2/3

164274

164224

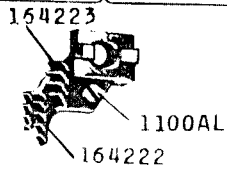

164225



164228

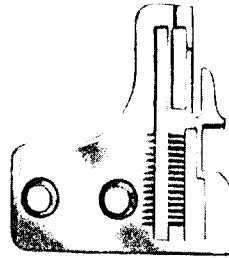

164308



164317

164350



164150

164221 164220

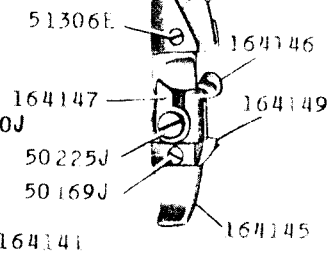

164179

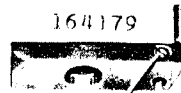

853AL

164055



164151

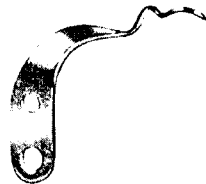

164175



164091



24779 - 2/3

164332

164324

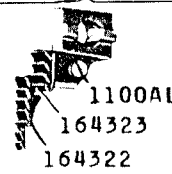

164325



164331

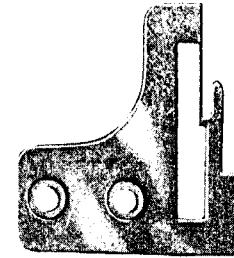

164258



164330

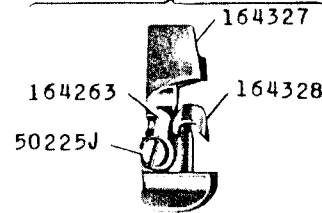

164268

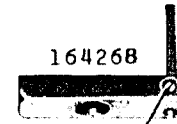

853AL

164287



164288



164026



164055



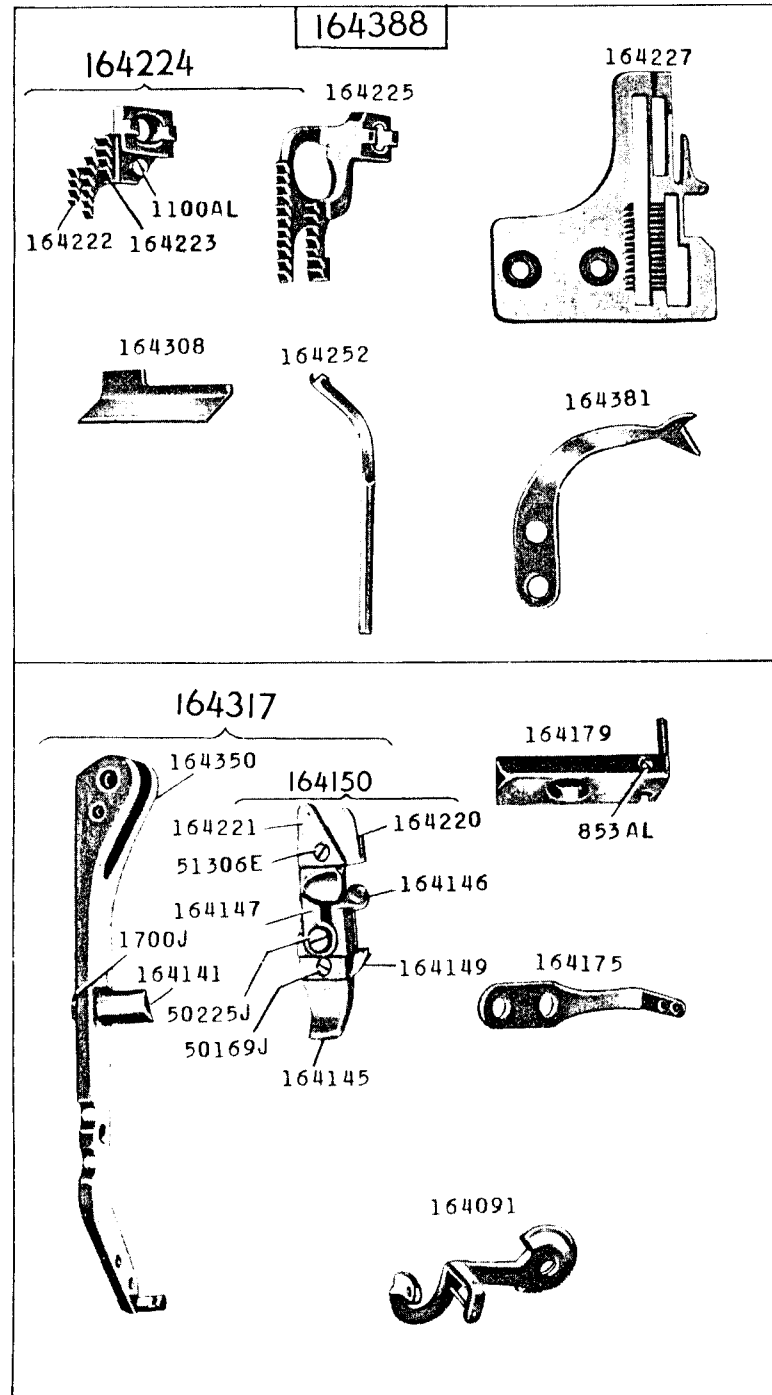
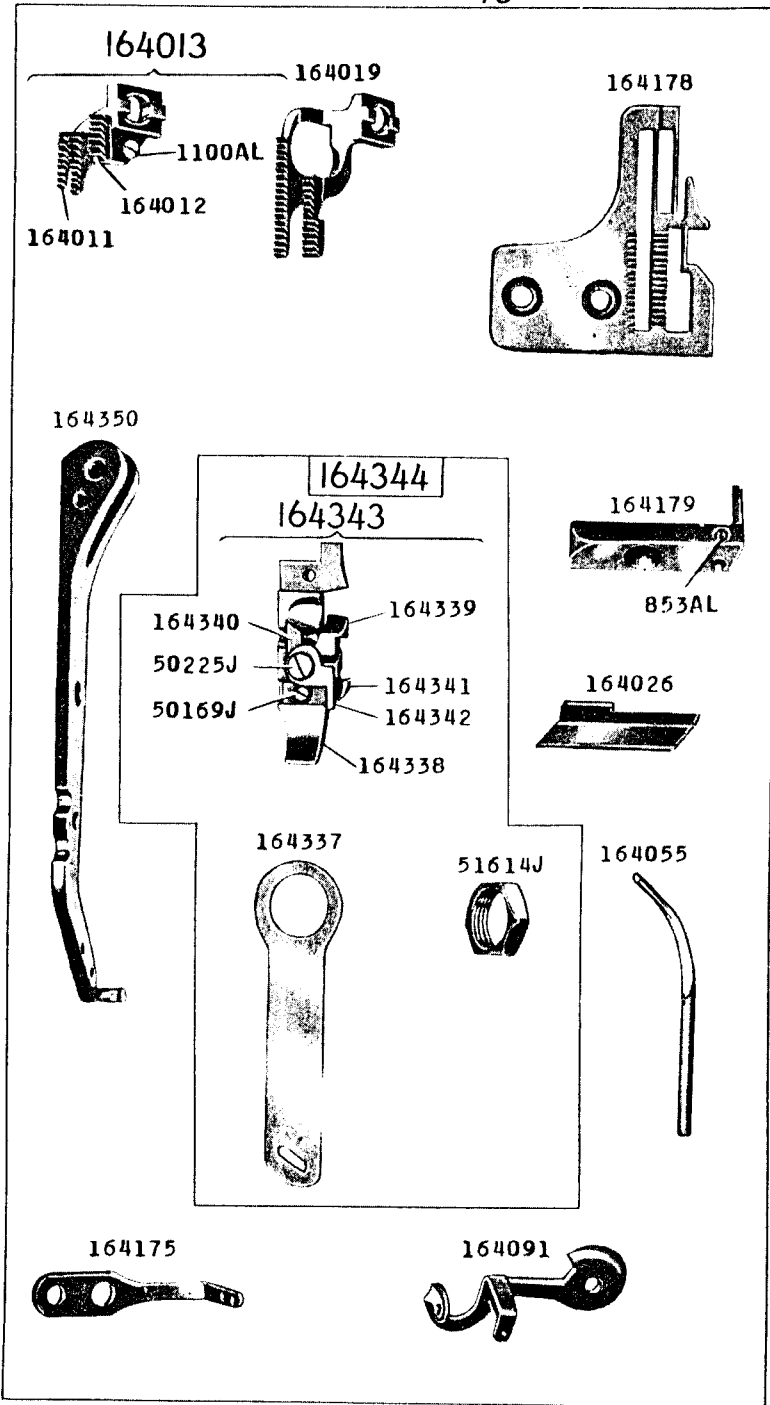

24782 - 2/3

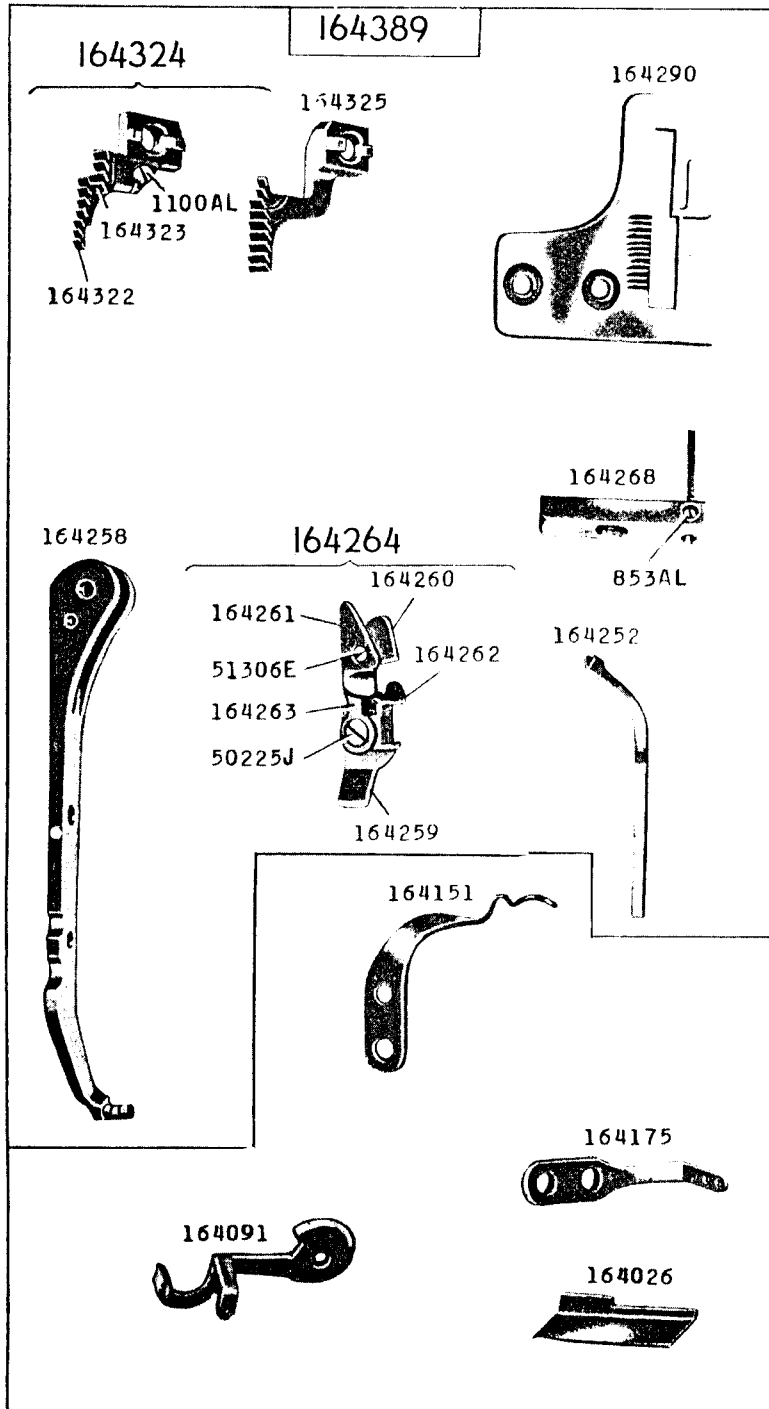

24783 - 2/3

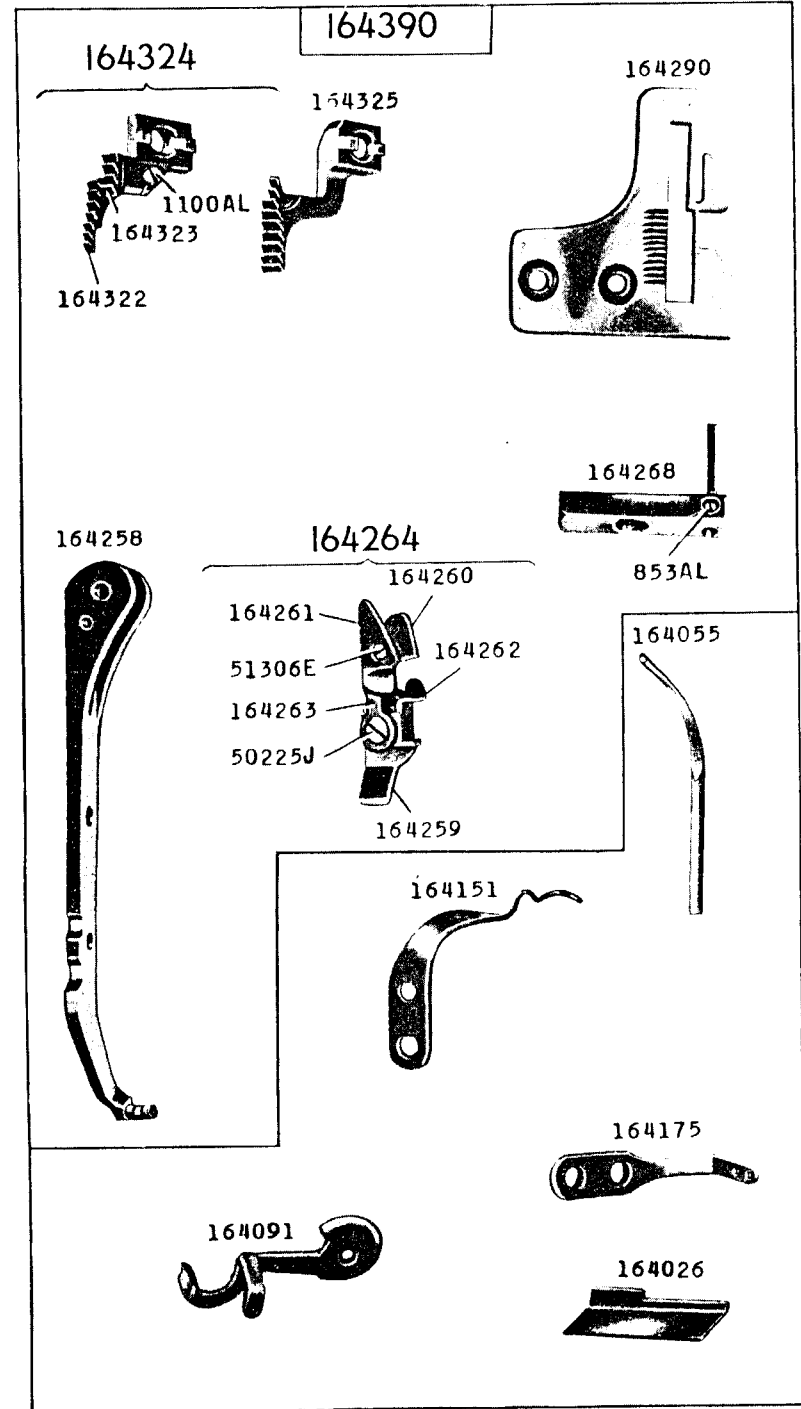

24784 - 2/3

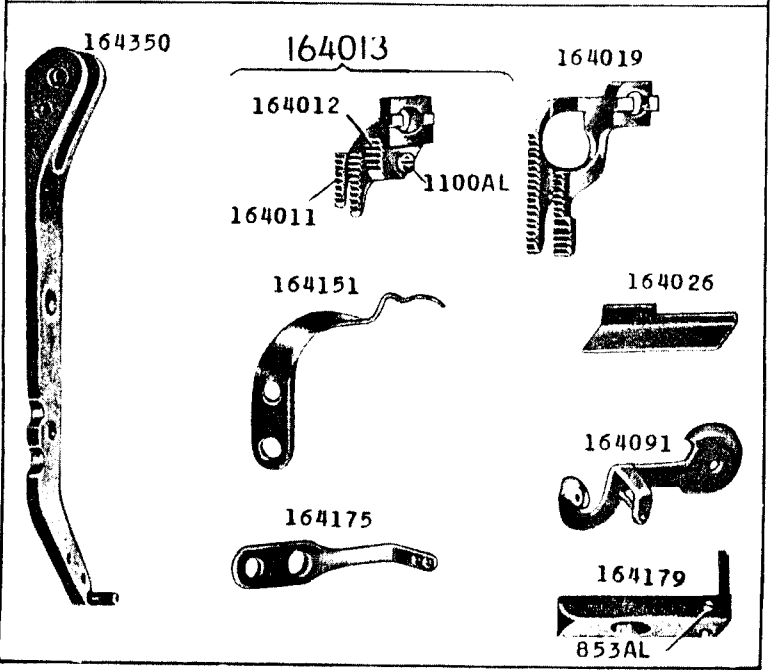
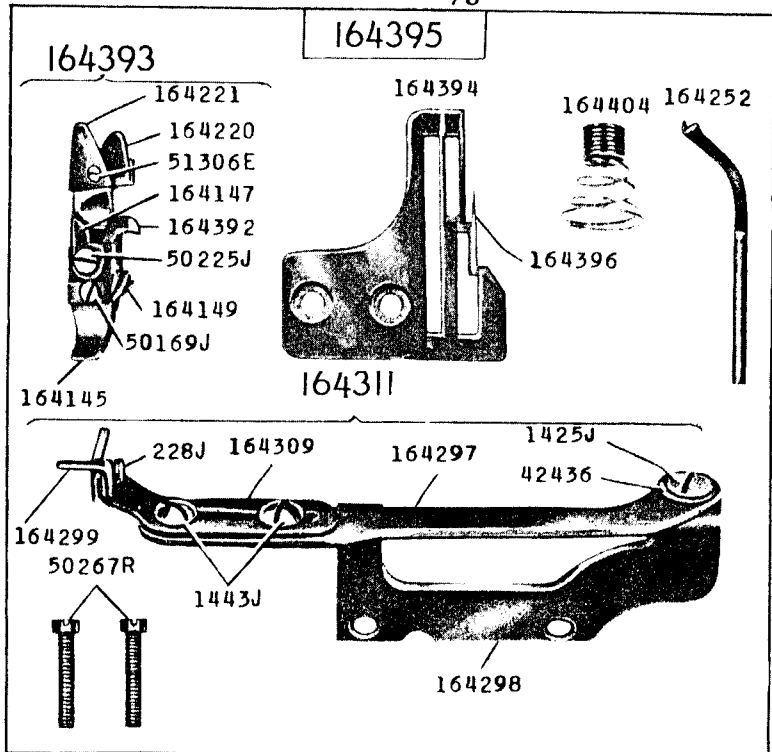

24785 - 2/3

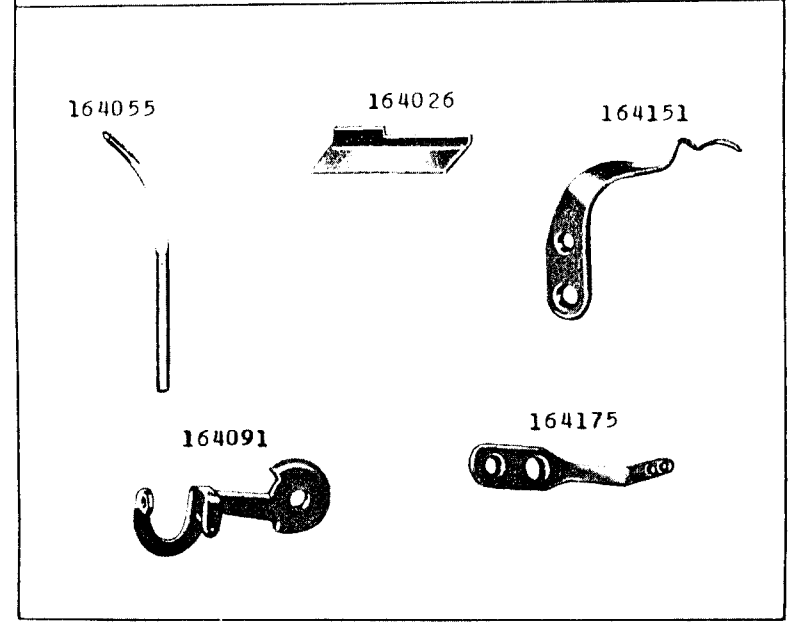
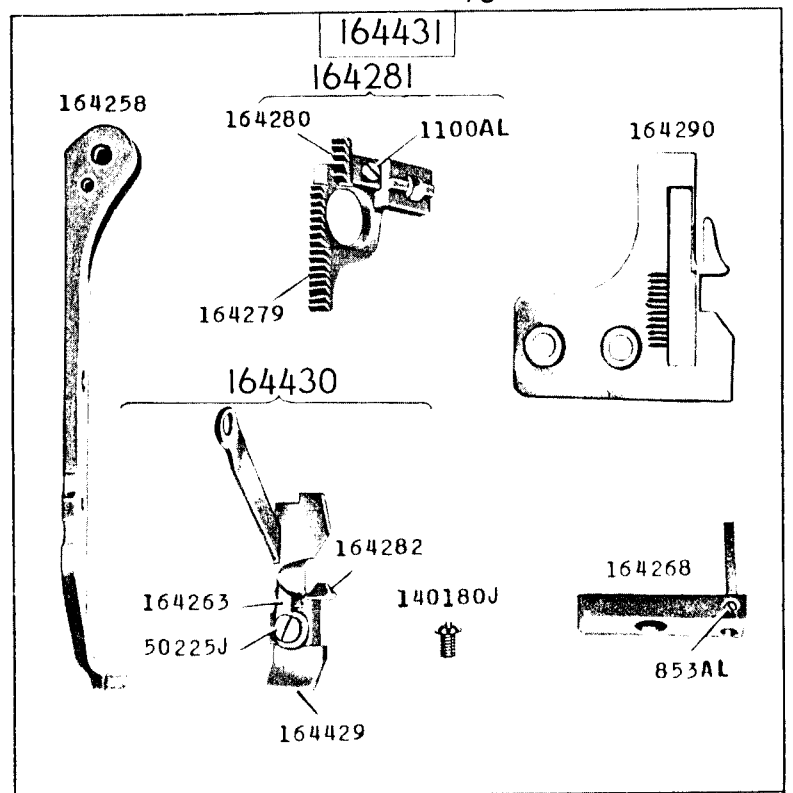

24786 - 2/3

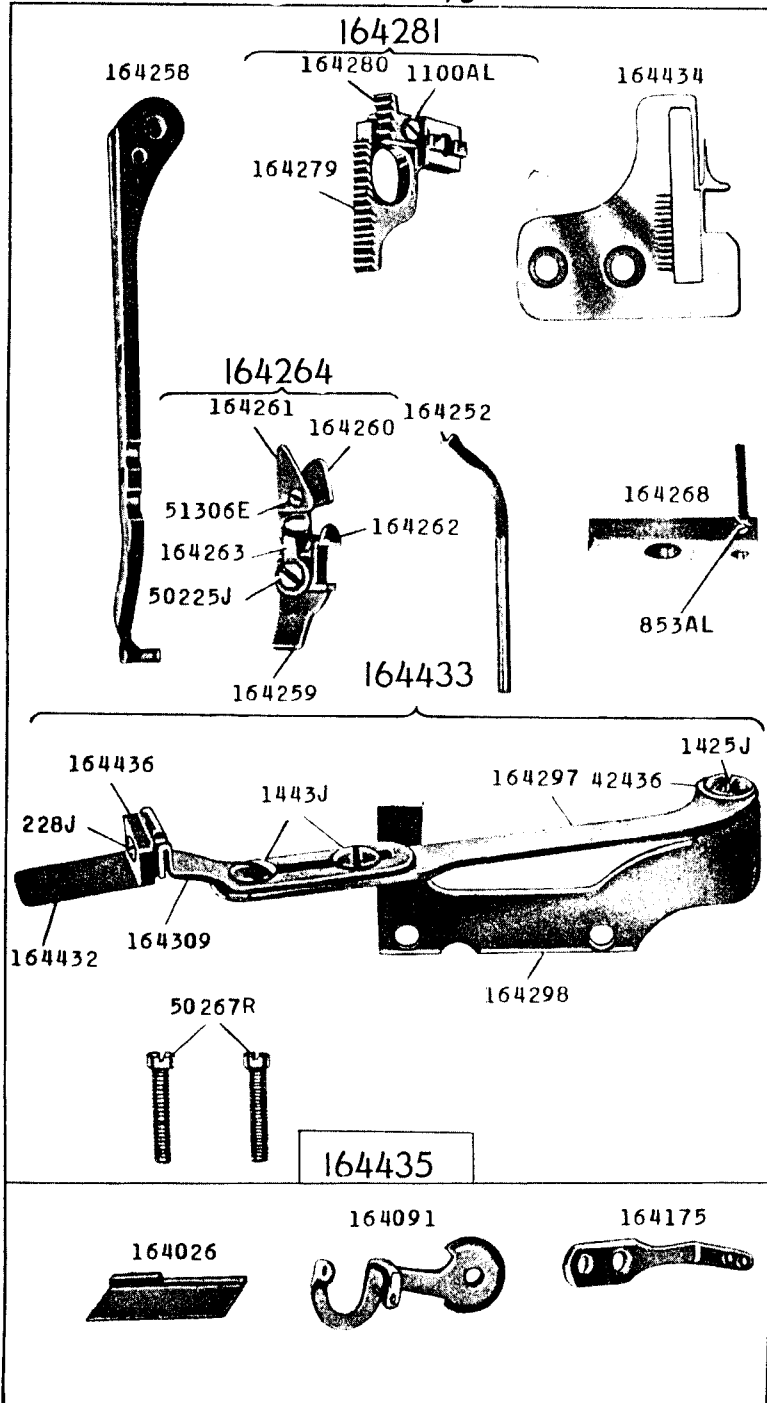

24787 - 2/3

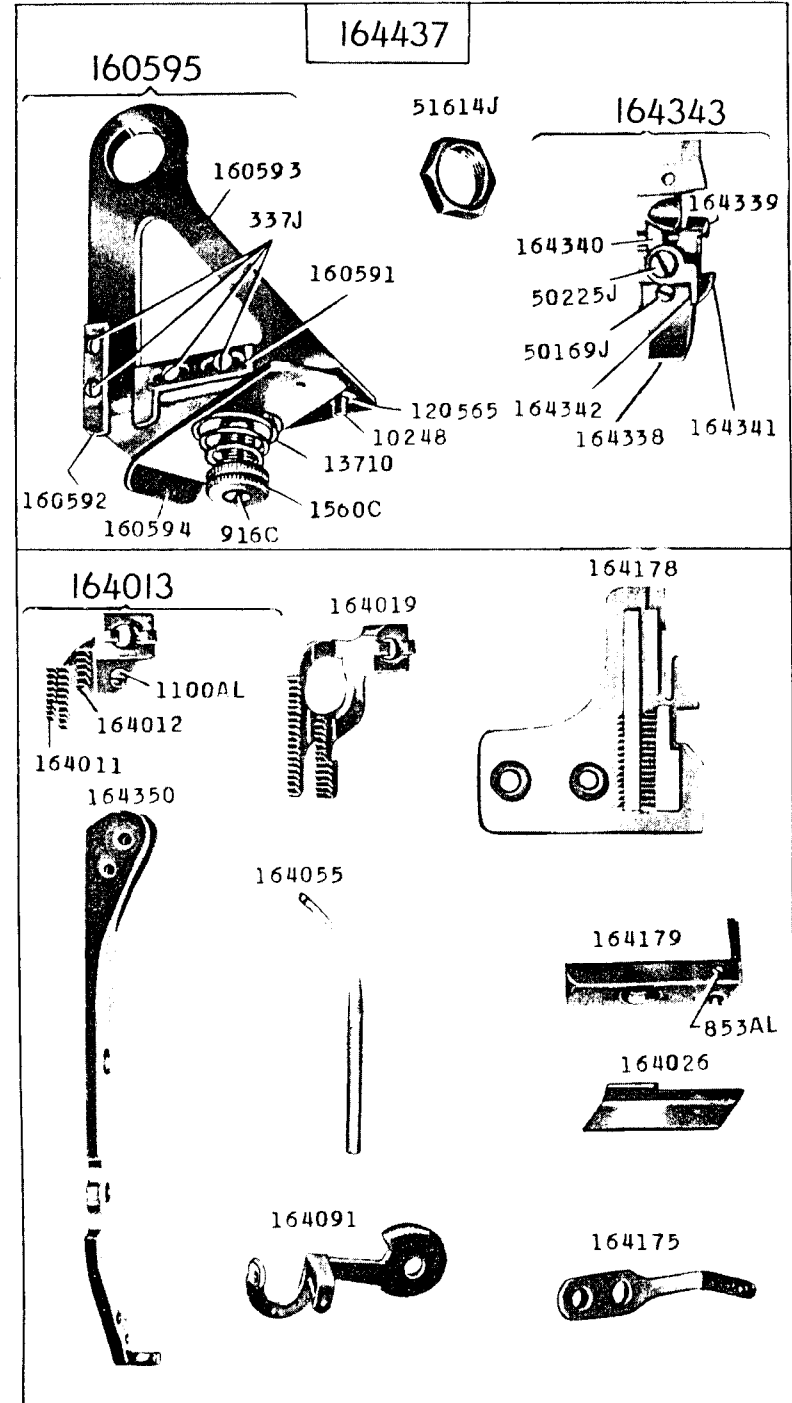

164256

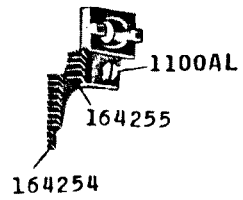

164257



164290

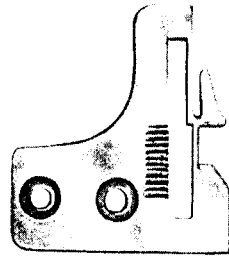

164258

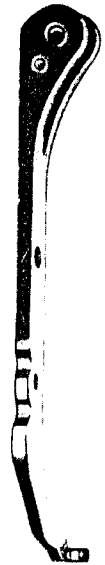

164264

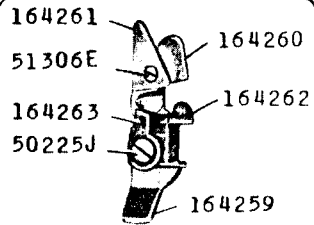

164268

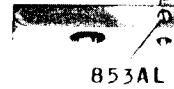

164381

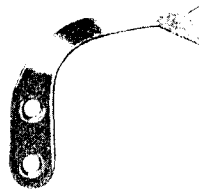

164287



164288

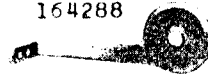

164451

164055



164026

