

SINGER
253-11,-12

Chain of fittings for 253-11

142357 FD

142362 TP

142361 PF

Form 20929

(1157)

Printed in U.S.A.

LIST OF PARTS



SINGER^{**}

MACHINES

Nos. 253-11 and 253-12

THE SINGER MANUFACTURING COMPANY

** A Trademark of THE SINGER MANUFACTURING COMPANY

INSTRUCTIONS FOR OILING

Before starting the machine, fill the oil reservoir in the base to the HIGH MARK with TYPE A or TYPE C OIL, sold by Singer Sewing Machine Company, as instructed in Form 20747.

TYPE C OIL is to be used, when an oil is desired which will produce a minimum of stain on fabrics, even after a long period of storage.

The reservoir holds approximately 1-1/2 pints.

When in operation, the oil level in the reservoir should be frequently inspected to keep it from going below the LOW MARK in the reservoir. Refill to HIGH MARK with TYPE A or TYPE C OIL.

INDEX

	Page
Accessories	27
Belt Guard (Hinged)	27
Face Plate Thread Lubricator	28
Fittings for 253-11 Machine	22
Fittings for 253-12 Machine	23
Foot Lifter Parts	28
Knee Lifter Parts	28
Machine No. 253-11.....	7
Machine No. 253-12.....	21
Numerical List of Parts	31
Set of Fittings Complete No. 160702.....	24
Set of Fittings Complete No. 161032.....	25
Set of Fittings Complete No. 161033.....	26
Thread Unwinder for two Spools.....	29

INSTRUCTIONS FOR ORDERING

In ordering from this list, use ONLY the part NUMBER in the FIRST column.

The number stamped on a Sewing Machine Part is in every case the number of the single part only.

Every combination of parts sent out as such has its specific number, which, although not stamped on the parts, must be used when ordering the combination.

Each number always indicates the SAME PART in whatever list it appears, or for whatever machine.

The letters after some of the numbers indicate the style of finish only, as follows:

- A—Hardened, Polished, Nickel Plated and Buffed
- B—Polished, Nickel Plated and Buffed
- C—Hardened Only
- D—Polished Only
- E—Soft, Not Polished
- F—Hardened and Polished
- G—Bright Rumbled and Nickel Plated
- H—Blued
- J—Nickel Plated Only
- K—Hardened and Nickel Plated
- L—Brass Plated
- M—Oxidized
- R—Phosphate Coating Formed on Surface of Iron or Steel
- S—Cadmium Plated
- T—Copper Plated
- U—Zinc Plated
- V—Silver Plated
- W—Polished and Nickel Plated
- X—Black Oxide for Iron and Steel
- Y—Black Nickel Plated Only
- Z—Chromium Plated
- A.A—Buffed and Chromium Plated
- A.B—Hardened, Polished, Buffed and Chromium Plated
- A.E—Hardened, Bright Rumbled and Nickel Plated
- A.F—Hardened, Bright Rumbled, Nickel Plated, Bright Rumbled and Chromium Plated
- A.G—Alumilite (Plain)
- A.H—Alumilite (Dyed) Color Must be Stated
- A.J—Polished, Nickel Plated and Chromium Plated
- A.K—Hardened, Polished, Nickel Plated and Chromium Plated
- A.L—Heat Treated for Toughness
- A.L.D—Heat Treated for Toughness and Polished
- A.L.X—Heat Treated for Toughness and Black Oxide

INSTRUCTIONS FOR ORDERING

- A.S—Black Moulded Phenolic
- A.T—Beige Moulded Phenolic
- A.U—Brown Moulded Phenolic
- A.W—Hardened then Flame Coated with Tungsten Carbide
- B.A—Chrome Nickel Satin Finish
- B.B—Hardened and Chrome Nickel, Satin Finished
- C.R—Hardened and Phosphate Coating Formed on Surface of Steel
- F.J—Hardened, Polished and Nickel Plated
- T.A—Hardened, Polished, Copper and Nickel Plated and Buffed
- T.B—Copper and Nickel Plated and Polished
- T.J—Copper and Nickel Plated Only
- T.K—Hardened, Copper and Nickel Plated
- T.L—Copper and Brass Plated
- T.M—Copper Plated and Oxidized
- X.C—Hardened and Black Oxide for Iron and Steel
- Z.A—Hardened, Polished Nickel Plated, Buffed and Chromium Plated
- Z.B—Polished, Nickel Plated, Buffed and Chromium Plated
- Z.C—Hardened and Chromium Plated
- Z.D—Polished and Chromium Plated
- Z.G—Bright Rumbled, Nickel Plated, Bright Rumbled and Chromium Plated
- Z.J—Nickel and Chromium Plated
- Z.T—Copper and Chromium Plated

These letters MUST BE USED when they appear in the list; and AFTER the number as in the list.

In this series:

1 to 1500, 50001 to 51500 and 140001 to 142,000 are screw numbers
1501 to 1800 and 51500 to 51800 are nut numbers
1801 to 2000 and 51801 to 52000 are roller numbers
2001 to 50000 and 52001 to 140000 and 142001 to 190000 are Sewing Machine Parts, 190001 and upward are numbers of Electrical Parts.

The figures in the second column refer only to the plates, illustrating the parts, and are NOT TO BE USED in ordering.

Parts marked with an asterisk (*) are furnished only when repairs are made at the factory.

LIST OF PARTS COMPLETE

FOR

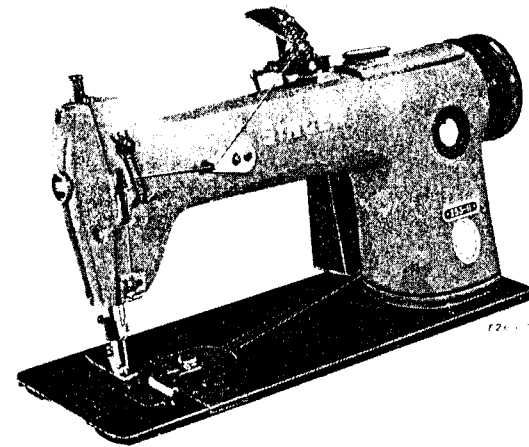

MACHINE NO. 253-11

FOR SEWING MEDIUM WEIGHT FABRICS. ONE NEEDLE, ONE LOOPER. LENGTH OF STITCHES: 6 TO 22 TO THE INCH. NEEDLE BAR STROKE: 1 3/16". SPEED: 5200, DEPENDING ON MATERIAL USED AND OPERATION PERFORMED.

No.	Plate	Name
*146863	-----	Arm.....
		NOTE: When ordering No. 146863, state color required.
16532	25037	Arm Dowel Pin (2).....
146552	25037	Arm Screw (front) (2).....
146551	25037	Arm Screw Stud (back) (2).....
146651	25070	Arm Shaft (horizontal) with Needle Bar Crank and 1036AL, 140542AL and 140552AL.....
146670	-----	Arm Shaft (horizontal) 146651 with 146581.
*146864	25070	Arm Shaft (horizontal) Bevel Gear, right hand spiral with 140333AL and two 1259AL.....
140333AL	25070	Arm Shaft (horizontal) Bevel Gear Position Screw.....
1259AL	25070	Arm Shaft (horizontal) Bevel Gear Set Screw (2).....
143008	25070	Arm Shaft (horizontal) Bushing (center)...
140296AL	25070	Arm Shaft (horizontal) Bushing (center) Set Screw.....
147112	25070	Arm Shaft (horizontal) Flanged Bushing (back).....

No.	Plate	Name
146790	25070	Arm Shaft (horizontal) Flanged Bushing (back) Oil Sump Tube with Holder
207E	25070	Arm Shaft (horizontal) Flanged Bushing (back) Oil Sump Tube Holder Screw
140296AL	25070	Arm Shaft (horizontal) Flanged Bushing (back) Set Screw
146672	25070	Arm Shaft (horizontal) Flanged Bushing (front)
140331AL	25070	Arm Shaft (horizontal) Flanged Bushing (front) Set Screw
144D	25070	Arm Shaft (horizontal) Screw (back)
140359E	25070	Arm Shaft (horizontal) Screw Plug (front)
143236	25070	Arm Shaft (horizontal) Screw Plug (front) Washer (fiber)
146661	25070	Arm Shaft (upright)
143015	25070	Arm Shaft (upright) Bevel Gear (lower) left hand spiral, with two 1259AL
1259AL	25070	Arm Shaft (upright) Bevel Gear (lower) Set Screw (2)
143015	25070	Arm Shaft (upright) Bevel Gear (upper) left hand spiral, with two 1259AL
1259AL	25070	Arm Shaft (upright) Bevel Gear (upper) Set Screw (2)
146505	25070	Arm Shaft (upright) Bushing (lower)
140298AL	25070	Arm Shaft (upright) Bushing (lower) Set Screw
147111	25070	Arm Shaft (upright) Bushing (upper)
140298AL	25070	Arm Shaft (upright) Bushing (upper) Set Screw
146867	25074	Arm Top Cover
		NOTE: When ordering No. 146867, state color required.
146868	25074	Arm Top Cover and Stitch Regulator Cap
		NOTE: When ordering No. 146868, state color required.
146869	25074	Arm Top Cover and Stitch Regulator Cap complete, Nos. 335X, 146868, 146870 and 146871
146870	25074	Arm Top Cover and Stitch Regulator Cap Gasket
146871	25074	Arm Top Cover and Stitch Regulator Cap Latch
335X	25074	Arm Top Cover and Stitch Regulator Cap Latch Screw
146508	25074	Arm Top Cover Gasket
51369R	25074	Arm Top Cover Screw (4)
146872	25075	Attachment Slide
146873	25075	Attachment Slide complete, Nos. 51282X, 146872 and 146874
146874	25075	Attachment Slide Spring
51282X	25075	Attachment Slide Spring Screw
*146876	-----	Bed with 146570 and two each 126150 and 140734E

NOTE: Due to Accuracy required for gear alignment, Bed cannot be supplied separately and can only be sent out as a unit, Arm and Bed assembled.

No.	Plate	Name
143024	25070	Bed Hole Plug
146514	25037	Bed Leg (back)
965E	25037	Bed Leg (back) Screw (2)
146877	25037	Bed Leg (front, long)
146516	25073	Bed Rotary Shaft
146650	-----	Bed Rotary Shaft 146516 with 146558
146517	25073	Bed Rotary Shaft Bevel Gear, right hand spiral, with two 1259AL
1259AL	25073	Bed Rotary Shaft Bevel Gear Set Screw (2)
146518	25073	Bed Rotary Shaft Bushing (back)
50554AL	25073	Bed Rotary Shaft Bushing (back) Set Screw
146519	25073	Bed Rotary Shaft Bushing (front)
50554AL	25073	Bed Rotary Shaft Bushing (front) Set Screw
146520	25073	Bed Rotary Shaft Bushing (intermediate)
448AL	25073	Bed Rotary Shaft Bushing (intermediate) Set Screw
64342	25073	Bed Rotary Shaft Collar with 454AL
454AL	25073	Bed Rotary Shaft Collar Set Screw
146521	25041	Bed Slide (left)
4307	25041	Bed Slide (left) Spring
725X	25041	Bed Slide (left) Spring Screw (2)
146522	25041	Bed Slide (left) complete, Nos. 4307, 146521 and two 725X
146006	25075	Bed Slide (right, button type) for 146007
146523	25089	Bed Slide (right, button type) for 146526
146834	-----	Bed Slide (right, button type) for 146835
146848	-----	Bed Slide (right, button type) for 146846
146849	-----	Bed Slide (right, button type) for 146847
146061	25075	Bed Slide (right, Latch Type) for 146062
146687	-----	Bed Slide (right, Latch Type) for 146692
146722	-----	Bed Slide (right, Latch Type) for 146723
146820	-----	Bed Slide (right, Latch Type) for 146821
146827	-----	Bed Slide (right, Latch Type) for 146828
146007	25075	Bed Slide (right, button type) complete for Throat Plates with no off-set, Nos. 1423X, 146006, 146524, 146525 and two 240C
146526	25089	Bed Slide (right, button type) complete for Throat Plates with 3/64 in. off-set, Nos. 1423X, 146523, 146524, 146525 and two 240C
146835	-----	Bed Slide (right, button type) complete for Throat Plates with 3/32 in. off-set, Nos. 1423X, 146524, 146525, 146834 and two 240C
146846	-----	Bed Slide (right, button type) complete for Throat Plates with 9/64 in. off-set, Nos. 1423X, 146524, 146525, 146848 and two 240C
146847	-----	Bed Slide (right, button type) complete for Throat Plates with 3/16 in. off-set, Nos. 1423X, 146524, 146525, 146849 and two 240C

No.	Plate	Name
146062	25075	Bed Slide (right, latch type) complete for Throat Plates with no off-set, Nos. 146061, 146688, 146689, 146690, 146691 and four 1470X.
146692	-----	Bed Slide (right, latch type) complete for Throat Plates with 3/64 in. off-set, Nos. 146687, 146688, 146689, 146690, 146691 and four 1470X.
146828	-----	Bed Slide (right, latch type) complete for Throat Plates with 3/32 in. off-set, Nos. 146688, 146689, 146690, 146691, 146827 and four 1470X.
146723	-----	Bed Slide (right, latch type) complete for Throat Plates with 9/64 in. off-set, Nos. 146688, 146689, 146690, 146691, 146722 and four 1470X.
146821	-----	Bed Slide (right, latch type) complete for Throat Plates with 3/16 in. off-set Nos. 146688, 146689, 146690, 146691, 146820 and four 1470X.
146525	25088	Bed Slide (right) Knob.
146688	25075	Bed Slide (right) Latch.
146689	25075	Bed Slide (right) Latch Guide.
1470X	25075	Bed Slide (right) Latch Guide Screw (2).
146690	25075	Bed Slide (right) Latch Spring.
146691	25075	Bed Slide (right) Spring.
146524	25075	Bed Slide (right) Spring.
1423X	25075	Bed Slide (right) Spring Screw.
1470X	25075	Bed Slide (right) Spring Screw (2).
240C	25075	Bed Slide (right) Spring Stop Screw (2).
146913	-----	Combination of Feed and Stitch Regulator Parts, Nos. 143015, 146537, 146545, 146864, 146883 and 146914.
160618	25082	Edge Guide.
922W	25082	Edge Guide Thumb Screw.
146528	25041	Face Plate.
		NOTE: When ordering No. 146528, state color required.
146529	25041	Face Plate Gasket.
140061J	25041	Face Plate Screw (lower) (3).
140050J	25041	Face Plate Screw (upper).
146879	25072	Feed Bar.
146880	-----	Feed Bar 146879 with 1607X and 140695X.
146949	-----	Feed Bar 146880 with 146935.
147022	25072	Feed Bar Carrier with two each 158E and 176E.
158E	25072	Feed Bar Carrier Clamping Screw (2).
147023	25072	Feed Bar Carrier Hinge Pin.
176E	25072	Feed Bar Carrier Hinge Pin Clamping Screw (2).
143031	25072	Feed Bar Carrier Oil Wick.
143032	25072	Feed Bar Carrier Oil Wick Holder.
147024	-----	Feed Bar Carrier Oil Wick Holder 143032 with 143031.

No.	Plate	Name
228E	25072	Feed Bar Carrier Oil Wick Holder Screw (2).
146934	25072	Feed Bar Slide Block.
146881	25072	Feed Bar Slide Block Oil Wick.
146539	25072	Feed Bar Slide Block Oil Wick Holder.
146882	-----	Feed Bar Slide Block Oil Wick Holder 146539 with 146881.
50579J	25072	Feed Bar Slide Block Oil Wick Holder Screw.
146008	25082	Feed Dog, 10 teeth (10 teeth to the inch) for use with 146033.
157J	25082	Feed Dog Screw.
140695X	25072	Feed Dog Stop Screw.
1607X	25072	Feed Dog Stop Screw Nut.
51061AL	25070	Feed Eccentric Body Set Screw (3).
7071	25070	Feed Eccentric Clamping Washer (2).
217J	25070	Feed Eccentric Clamping Washer Screw (2).
146883	25070	Feed Eccentric (adjustable) complete, Nos. 50328C two each 217J, 7071 and three 51061AL.
146914	25070	Feed Lifting Eccentric with three 440AL.
440AL	25070	Feed Lifting Eccentric Set Screw (3).
146885	25072	Feed Lifting Rock Shaft.
143052	25072	Feed Lifting Rock Shaft and Feed Rock Shaft Oil Wick Holder.
228E	25072	Feed Lifting Rock Shaft and Feed Rock Shaft Oil Wick Holder Screw.
147042	25072	Feed Lifting Rock Shaft Bushing (back).
146933	25072	Feed Lifting Rock Shaft Bushing (front).
447AL	25072	Feed Lifting Rock Shaft Bushing Set Screw (2).
143039	25072	Feed Lifting Rock Shaft Cap.
223E	25072	Feed Lifting Rock Shaft Cap Screw (2).
147029	25072	Feed Lifting Rock Shaft Collar with two 460AL (2).
460AL	25072	Feed Lifting Rock Shaft Collar Set Screw (4).
146537	25070	Feed Lifting Rock Shaft Connecting Rod.
146887	25070	Feed Lifting Rock Shaft Connecting Rod Hinge Pin.
462AL	25072	Feed Lifting Rock Shaft Connecting Rod Hinge Pin Set Screw.
146888	25072	Feed Lifting Rock Shaft Crank (back) with 462AL and two 50083AL.
50083AL	25072	Feed Lifting Rock Shaft Crank (back) Clamping Screw (2).
146889	25072	Feed Lifting Rock Shaft Crank (front) with 157X.
146935	-----	Feed Lifting Rock Shaft Crank (front) 146889 with 146934.
157X	25072	Feed Lifting Rock Shaft Crank (front) Clamping Screw.
146945	25072	Feed Lifting Rock Shaft Hole Plug.

No.	Plate	Name
140359E	25072	Feed Lifting Rock Shaft Oil Plug Screw . . .
143236	25072	Feed Lifting Rock Shaft Oil Plug Screw Washer (fiber)
146891	25072	Feed Lifting Rock Shaft Oil Wick
146892	25072	Feed Lifting Rock Shaft Oil Wick (long) . . .
147037	25072	Feed Lifting Rock Shaft Oil Wick (short) (2)
147047	25072	Feed Lifting Rock Shaft Oil Wick Clamping Plate
197E	25072	Feed Lifting Rock Shaft Oil Wick Clamping Plate Screw
50328C	25070	Feed Regulating Screw
146893	25072	Feed Rock Shaft
146894	-----	Feed Rock Shaft Nos. 197E, 140359E, 143236, 146891, 146893, 146896, 147047 and two 147045
147042	25072	Feed Rock Shaft Bushing (back)
147043	25072	Feed Rock Shaft Bushing (front)
447AL	25072	Feed Rock Shaft Bushing Set Screw (2) . . .
143048	25072	Feed Rock Shaft Cap
223E	25072	Feed Rock Shaft Cap Screw (2)
147029	25072	Feed Rock Shaft Collar with two 460AL . . .
460AL	25072	Feed Rock Shaft Collar Set Screw (2) . . .
146545	25070	Feed Rock Shaft Connecting Rod
146887	25070	Feed Rock Shaft Connecting Rod Hinge Pin. 462AL 25072 Feed Rock Shaft Connecting Rod Hinge Pin Set Screw
146895	25072	Feed Rock Shaft Crank with 462AL and two 157X
157X	25072	Feed Rock Shaft Crank Clamping Screw (2)
140359E	25072	Feed Rock Shaft Oil Plug Screw
143236	25072	Feed Rock Shaft Oil Plug Screw Washer (fiber)
146891	25072	Feed Rock Shaft Oil Wick
146896	25072	Feed Rock Shaft Oil Wick (long)
147045	25072	Feed Rock Shaft Oil Wick (short) (2)
147047	25072	Feed Rock Shaft Oil Wick Clamping Plate . .
197E	25072	Feed Rock Shaft Oil Wick Clamping Plate Screw
146016	25078	Looper
146017	25078	Looper 146016 with 229J and 131135
146550	25073	Looper Avoiding Eccentric with two 1259AL
146553	25073	Looper Avoiding Eccentric Connection (forked) with two 896AL
896AL	25073	Looper Avoiding Eccentric Connection Clamping Screw (2)
1259AL	25073	Looper Avoiding Eccentric Set Screw (2) . .
146554	25073	Looper Avoiding Eccentric Slide Block . . .
146556	25073	Looper Ball Crank
146897	25078	Looper Ball Crank Arm with 51320AL
146923	25078	Looper Ball Crank Arm 146897 with 1520J, 128551 and 146919
51320AL	25078	Looper Ball Crank Arm Clamping Screw . .
132790	25073	Looper Ball Crank Connection Ball Sleeve (two pieces)

No.	Plate	Name
164232	25073	Looper Ball Crank Connection Ball Sleeve Guide
146557	25073	Looper Ball Crank Connection Nos. two each 896AL, 51715AL, 131927 and 131928
146558	-----	Looper Ball Crank Connection 146557 with 132790, 146556 and 164232
896AL	25073	Looper Ball Crank Connection Cap (lower) Screw (2)
131927	25073	Looper Ball Crank Connection Cap (upper) Screw Stud (2)
51715AL	25073	Looper Ball Crank Connection Cap (upper) Screw Stud Nut (2)
131928	25073	Looper Ball Crank Connection Cap (upper) Screw Stud Nut Lock Washer (2)
146559	25073	Looper Ball Crank Hinge Pin
448AL	25073	Looper Ball Crank Hinge Pin Set Screw (2)
146948	25078	Looper Ball Crank Pitman Ball Screw Stud (right)
1520J	25078	Looper Ball Crank Pitman Ball Screw Stud (right) Nut
128551	25078	Looper Ball Crank Pitman Ball Screw Stud (right) Nut Locking Plate
146730	25078	Looper Ball Crank Pitman End Bearing (left) Body with two 175AL
175AL	25078	Looper Ball Crank Pitman End Bearing (left) Cap Screw (2)
1664J	25078	Looper Ball Crank Pitman End Bearing (left) Nut
146918	25078	Looper Ball Crank Pitman End Bearing (right) Body with two 175AL
175AL	25078	Looper Ball Crank Pitman End Bearing (right) Cap Screw (2)
146919	-----	Looper Ball Crank Pitman End Bearing (right) 146918 with 146948
146936	25078	Looper Ball Crank Pitman Rod
146937	25078	Looper Ball Crank Pitman Rod 146936 with 51769C
146938	25078	Looper Ball Crank Pitman Rod with Throw- out Device complete, Nos. 29043, 50169J, 146732, 146733, 146754, 146904, 146937 and two 51159J
51769C	25078	Looper Ball Crank Pitman Rod Nut
146947	25078	Looper Ball Crank Pitman Rod Oil Shield . .
51460E	25078	Looper Ball Crank Pitman Rod Oil Shield Screw
7071	25078	Looper Ball Crank Pitman Rod Oil Shield Screw Washer
146018	25078	Looper Holder with 896AL and 1253AL . . .
146741	25078	Looper Holder 146018 with 1664J, 146567 and 146730
146567	25078	Looper Holder Bushing (eccentric) with 146647
146647	25078	Looper Holder Bushing Pin
896AL	25078	Looper Holder Clamping Screw

No.	Plate	Name
146568	25073	Looper Holder Hinge Pin.....
146569	25073	Looper Holder Rock Shaft with 140439E....
*146570	-----	Looper Holder Rock Shaft Bracket
NOTE: Due to the accuracy required for Looper Rock Shaft alignment, Looper Holder Rock Shaft Bracket cannot be supplied separately and can only be sent out as a unit Arm, Bed and Looper Holder Rock Shaft Bracket assembled.		
143126	-----	Looper Holder Rock Shaft Bracket Oil Pipe Clamping Sleeve Adaptor.....
231E	-----	Looper Holder Rock Shaft Bracket Oil Plug Screw (2)
140734E	25037	Looper Holder Rock Shaft Bracket Screw (2)
126150	-----	Looper Holder Rock Shaft Bracket Screw Washer (2).....
146571	25073	Looper Holder Rock Shaft Bushing (back)...
448AL	25073	Looper Holder Rock Shaft Bushing (back) Set Screw
146572	25073	Looper Holder Rock Shaft Bushing (front)...
448AL	25073	Looper Holder Rock Shaft Bushing (front) Set Screw
140439E	25073	Looper Holder Rock Shaft Oil Plug Screw...
131135	25078	Looper Needle Guard with 46105.....
46105	25078	Looper Needle Guard Pin
229J	25078	Looper Needle Guard Screw.....
1253AL	25078	Looper Set Screw
146732	25078	Looper Throw-out Releaser
146733	25078	Looper Throw-out Releaser Cap.....
51159J	25078	Looper Throw-out Releaser Cap Screw (2)...
146754	25078	Looper Throw-out Sleeve
146904	25078	Looper Throw-out Spring
50169J	25078	Looper Throw-out Spring Screw
29043	25078	Looper Throw-out Spring Screw Washer...
146924	-----	Looper Throw-out Device and Pitman Rod complete, Nos. 1520J, 128551, 146919 and 146938 (for Agents only)
146512	25074	Machine Pulley (disc power) "V" belt groove (outside diameter of belt groove 2.9 in.) with two 51283AL
51283AL	25074	Machine Pulley Set Screw (2)
146960	25076	Needle Bar (hollow) with 140239AL
146961	-----	Needle Bar complete, Nos. 50579X, 146960 and 146962
146907	25076	Needle Bar Bushing (lower)
1133E	25076	Needle Bar Bushing (lower) Set Screw.....
146804	25076	Needle Bar Bushing (lower and upper) Oil Wick
146805	25076	Needle Bar Bushing (lower and upper) Oil Wick complete, Nos. 146703, 146804 and two 146580.....
146703	25076	Needle Bar Bushing (lower and upper) Oil Wick Clamp and Retainer

No.	Plate	Name
146580	25076	Needle Bar Bushing (lower and upper) Oil Wick Clip (2).....
146576	25076	Needle Bar Bushing (upper).....
1133E	25076	Needle Bar Bushing (upper) Set Screw
140440X	25076	Needle Bar Bushing (upper) Oil Plug Screw
146959	25076	Needle Bar Connecting Link.....
146581	-----	Needle Bar Connecting Link 146959 with 146582
146582	25070	Needle Bar Connecting Link Hinge Stud....
140552AL	25070	Needle Bar Connecting Link Hinge Stud Clamping Screw
1036AL	25070	Needle Bar Connecting Link Hinge Stud Position Set Screw
175E	25076	Needle Bar Connecting Stud Clamping Screw
139110	25076	Needle Bar Connecting Stud Oil Pad (wick)
139111	25076	Needle Bar Connecting Stud Slide Block ...
146908	25076	Needle Bar Connecting Stud Slide Block Guide.....
SS329E	25076	Needle Bar Connecting Stud Slide Block Guide Screw (2)
140542AL	25070	Needle Bar Crank Position Screw.....
146962	25076	Needle Bar Thread Guide.....
50579X	25076	Needle Bar Thread Guide Screw.....
146665	25047	Needle Bar Thread Retainer (lower)
146666	25047	Needle Bar Thread Retainer (upper)
146585	25047	Needle Bar Thread Retainer Bracket.....
146586	25047	Needle Bar Thread Retainer Bracket complete, Nos. 10107, 140546C, 146585, 146665, 146666 and two each 42483, 50163XC and 54865.....
402J	25047	Needle Bar Thread Retainer Bracket Screw
42483	25047	Needle Bar Thread Retainer Disc (2)
140546C	25047	Needle Bar Thread Retainer Disc Screw...
50163XC	25047	Needle Bar Thread Retainer Screw (2)....
54865	25047	Needle Bar Thread Retainer Screw Washer (2)
10107	25047	Needle Bar Thread Retainer Spring.....
146939	25075	Needle Guard.....
146742	25075	Needle Guard Holder
146743	25075	Needle Guard Holder Bracket
190J	25075	Needle Guard Holder Bracket Screw
190J	25075	Needle Guard Holder Screw
176J	25075	Needle Guard Screw.....
140239AL	25076	Needle Set Screw
146591	25046	Oil Flow Body.....
143061	25046	Oil Flow Body Gasket (2).....
143062	25046	Oil Flow Window
143063	25046	Oil Flow Window Cap.....
50257X	25046	Oil Flow Window Cap Screw (4)
143370	25046	Oil Lead.....
51369E	25046	Oil Lead Screw
146593	25046	Oil Pipe for 146597

No.	Plate	Name
146594	25010	Oil Pipe with two each 143124 and 143125 for oiling Bed Rotary Shaft Intermediate Bearing.....
146595	25010	Oil Pipe with two each 143124 and 143125 for oiling Looper Rock Shaft Hinge Pin..
146596	25010	Oil Pipe with two each 143124 and 143125 for oiling Thread (under) Take-up Shaft Front Bearing.....
143065	25046	Oil Pipe Clamping Sleeve, for 146597.....
143066	25046	Oil Pipe Clamping Sleeve Nut.....
146597	25046	Oil Pipe complete, from Oil Pump to Arm Shaft (horizontal) Center Bearing, Nos. 146593, 143065 and 143066 (for Agents only).....
143124	25010	Oil Pipe Clamping Sleeve (6).....
143126	25046	Oil Pipe Clamping Sleeve Adaptor for 146660 (3).....
143126	-----	Oil Pipe Clamping Sleeve Adaptor (fastened to Bed) (2).....
143125	25010	Oil Pipe Clamping Sleeve Nut (6).....
146659	25046	Oil Pump (centrifugal) Body.....
146660	-----	Oil Pump (centrifugal) Body 146659 with three 143126.....
143071	25046	Oil Pump (centrifugal) Body Position Pin(2)
157E	25046	Oil Pump (centrifugal) Body Screw (3)....
146600	25046	Oil Pump (centrifugal) Cover.....
143073	25046	Oil Pump (centrifugal) Impeller.....
50123E	25070	Oil Pump (centrifugal) Impeller Locking Screw.....
146657	25046	Oil Pump (centrifugal) Screen.....
146658	25046	Oil Pump (centrifugal) Screen Frame.....
189E	25046	Oil Pump (centrifugal) Screen Frame Screw (3).....
146744	25037	Oil Removing Wick (head end).....
146745	25037	Oil Removing Wick (head end) Holder Body
146746	-----	Oil Removing Wick (head end) Holder Body 146745 with 146698 and 146744 (for Agents only).....
140553E	25037	Oil Removing Wick (head end) Holder Body Hinge Screw.....
146698	25037	Oil Removing Wick (head end) Holder Body Spring.....
146700	25037	Oil Removing Wick (head end) Holder Body Stop and Spring Clip.....
228E	25037	Oil Removing Wick (head end) Holder Body Stop and Spring Clip Screw.....
146747	25037	Oil Removing Wick (head end) Holder Body complete, Nos. 228E, 140553E, 146696, 146697, 146698, 146700, 146744 and 146745.....
146696	25037	Oil Removing Wick (head end) Hinge Plate and Cover.....
146697	25037	Oil Removing Wick (head end) Hinge Plate and Cover Gasket.....

No.	Plate	Name
1364X	25037	Oil Removing Wick (head end) Hinge Plate and Cover Screw (3).....
146604	25073	Oil Wick for oiling Looper Ball Crank Pitman End Bearing (left).....
146605	25073	Oil Wick Holder.....
193D	25073	Oil Wick Holder Tube Bracket Screw.....
146606	25073	Oil Wick Position Bracket with 140239AL..
140239AL	25073	Oil Wick Position Bracket Screw.....
139462	25076	Presser Bar.....
146751	25076	Presser Bar Bushing (lower).....
1133E	25076	Presser Bar Bushing (lower) Set Screw..
146694	25076	Presser Bar Guide Bracket with 1057AL..
1057AL	25076	Presser Bar Guide Bracket Clamping Screw.....
146676	25077	Presser Bar Guide Bracket Lifter.....
807X	25077	Presser Bar Guide Bracket Lifter Hinge Stud.....
146791	25077	Presser Bar Lifting Lever.....
		NOTE: When ordering No. 146791, state color required.
146609	25077	Presser Bar Lifting Lever Extension.....
161X	25077	Presser Bar Lifting Lever Extension Screw (2).....
802X	25077	Presser Bar Lifting Lever Hinge Screw..
146610	25077	Presser Bar Lifting Lever Spring.....
146611	25076	Presser Bar Spring.....
146612	25076	Presser Bar Spring Guide Pin.....
146752	25076	Presser Bar Stop with 190J.....
190J	25076	Presser Bar Stop Clamping Screw.....
131256	25082	Presser Foot Hinge Pin.....
59262	25082	Presser Foot Knife.....
239C	25082	Presser Foot Knife Screw.....
146027	25082	Presser Foot Plate.....
146028	25082	Presser Foot Shank with 725J.....
725J	25082	Presser Foot Shank (adjusting) Screw....
146029	25082	Presser Foot (hinged) complete, Nos. 239C, 59262, 131256, 146027 and 146028
190J	25076	Presser Foot Screw.....
140441W	25076	Pressure Regulating Thumb Screw.....
51614W	25076	Pressure Regulating Thumb Screw Nut...
146617	25080	Slack Thread Controller.....
54242	25080	Slack Thread Controller Clamp.....
176J	25080	Slack Thread Controller Clamp Screw....
140239AL	25080	Slack Thread Controller Position Screw..
2102	25081	Tension (looper thread) Disc (2).....
51570C	25081	Tension (looper thread) Regulating Thumb Nut.....
146792	25079	Tension (looper thread) Releaser.....
146793	25079	Tension (looper thread) Releaser Fastening Plate.....
146794	25079	Tension (looper thread) Releaser Slide...
146620	25079	Tension (looper thread) Releaser Slide Connecting Link.....
110C	25079	Tension (looper thread) Releaser Slide Connecting Link Hinge Screw.....

No.	Plate	Name
72C	25079	Tension (looper thread) Releaser Slide Hinge Screw (2).....
217J	25079	Tension (looper thread) Releaser Screw.....
146800	25079	Tension (looper thread) Releaser Nos. 110C, 217J 146620, 146792, 146793, 146794, 146795, 146796, 146797 and two 72C.....
140442C	25081	Tension (looper thread) Screw Stud.....
146618	-----	Tension (looper thread) Screw Stud 140442C with 51570C.....
131740	25081	Tension (looper thread) Spring.....
59537	25081	Tension (looper thread) Spring Bushing (large).....
59538	25081	Tension (looper thread) Spring Bushing (small).....
146619	25081	Tension (looper thread) Thread Guard.....
914J	25081	Tension (looper thread) Thread Guard Screw.....
131696	25081	Tension (looper thread) Thread Guide.....
54070	25077	Tension (needle thread) Bracket.....
140443J	25077	Tension (needle thread) Bracket Screw.....
2102	25077	Tension (needle thread) Disc (2).....
51570C	25077	Tension (needle thread) Regulating Thumb Nut.....
32572	25077	Tension (needle thread) Releasing Disc.....
54988	25077	Tension (needle thread) Releasing Pin.....
54071	25077	Tension (needle thread) Releasing Shaft.....
54872	25077	Tension (needle thread) Releasing Shaft Crank with 624AL.....
146620	25077	Tension (needle thread) Releasing Shaft Crank Connecting Link.....
110C	25077	Tension (needle thread) Releasing Shaft Crank Connecting Link Hinge Screw.....
624AL	25077	Tension (needle thread) Releasing Shaft Crank Set Screw.....
68261	25077	Tension (needle thread) Releasing Shaft Spring.....
316C	25077	Tension (needle thread) Releasing Shaft Stop Screw.....
1547J	25077	Tension (needle thread) Releasing Shaft Stop Screw Nut.....
50326C	25077	Tension (needle thread) Screw Stud.....
59539	-----	Tension (needle thread) Screw Stud 50326C with 51570C.....
225X	25077	Tension (needle thread) Screw Stud Hole Plug.....
131741	25077	Tension (needle thread) Spring.....
59537	25077	Tension (needle thread) Spring Bushing (large).....
59538	25077	Tension (needle thread) Spring Bushing (small).....
131696	25077	Tension (needle thread) Thread Guide.....
146621	25073	Thread (looper) Take-up with 465AL.....
1029J	25073	Thread (looper) Take-up Screw.....

No.	Plate	Name
146622	25073	Thread (looper) Take-up Screw Washer (fiber).....
465AL	25073	Thread (looper) Take-up Set Screw.....
146623	25047	Thread (looper) Take-up Stripper.....
146624	25047	Thread (looper) Take-up Stripper Holder with 906AL.....
146625	25047	Thread (looper) Take-up Stripper Plate.....
146603	-----	Thread (looper) Take-up Stripper Plate 146625 with 237J, 139148, 146623, 146624, 146626, 146628 and two 190J.....
237J	25047	Thread (looper) Take-up Stripper Plate Screw.....
146626	25047	Thread (looper) Take-up Stripper Plate Support Plate (2).....
NOTE: One No. 146626 is screwed onto Machine Bed.		
190E	25047	Thread (looper) Take-up Stripper Plate Support Plate Screw (4).....
906AL	25047	Thread (looper) Take-up Stripper Set Screw.....
139148	25047	Thread (looper) Take-up Stripper Staple.....
190J	25047	Thread (looper) Take-up Stripper Staple Screw (2).....
146627	25047	Thread (looper) Take-up Thread Guide (left).....
237J	25047	Thread (looper) Take-up Thread Guide (left) Screw.....
146628	25047	Thread (looper) Take-up Thread Guide (right).....
237J	25047	Thread (looper) Take-up Thread Guide (right) Screw.....
1628X	25081	Thread (looper) Thread Tube Screw Stud Nut.....
146671	25081	Thread (looper) Thread Tube Screw Stud Nut Washer.....
146631	25081	Thread (looper) Thread Tube.....
146632	25081	Thread (looper) Thread Tube Thread Guide.....
50027J	25081	Thread (looper) Thread Tube Thread Guide Screw.....
146795	25079	Thread (looper) Uncurler.....
146796	25079	Thread (looper) Uncurler Plate (back).....
146797	25079	Thread (looper) Uncurler Plate (front).....
146031	25080	Thread (needle) Eyelet (side of arm).....
176J	25080	Thread (needle) Eyelet (side of arm) Position Screw.....
7071	25080	Thread (needle) Eyelet (side of arm) Position Screw Washer.....
724J	25080	Thread (needle) Eyelet (side of arm) Screw.....
146032	25076	Thread (needle) Take-up with 51460E.....
51460E	25076	Thread (needle) Take-up Clamping Screw.....
54194	25076	Thread (needle) Take-up Plate.....
68164	25076	Thread (needle) Take-up Plate Spring.....
1449J	25076	Thread (needle) Take-up Plate Spring Screw.....

No.	Plate	Name
146042	25076	Thread (needle) Take-up complete, Nos. 1449J, 54194, 68164 and 146032.....
139158	25080	Thread (needle) Uncurler
146629	25080	Thread (needle) Uncurler Bracket.....
140443J	25080	Thread (needle) Uncurler Bracket Screw..
146630	25080	Thread (needle) Uncurler Bracket Support
		NOTE: When ordering No. 146630, state color required.
217J	25080	Thread (needle) Uncurler Bracket Support (lower) Screw
237J	25080	Thread (needle) Uncurler Bracket Support (upper) Screw.....
229J	25080	Thread (needle) Uncurler Screw (2).....
146033	25082	Throat Plate for use with 146008.....
691F	25082	Throat Plate Screw (2)

SINGER Needles should be used
in SINGER Machines
These Needles and their Containers
are marked with the
Company's Trademark "SIMANCO" 1

Needles in Containers marked
"FOR SINGER MACHINES"
are NOT SINGER made needles 2

MACHINE NO. 253-12

FOR SEWING MEDIUM HEAVY AND HEAVY WEIGHT FABRICS. ONE NEEDLE, ONE LOOPER. LENGTH OF STITCHES: 5 TO 22 TO THE INCH. NEEDLE BAR STROKE: 1 5/16". SPEED: 4500, DEPENDING ON MATERIAL USED AND OPERATION PERFORMED.

This Machine is the same as the No. 253-11
Machine, with the following exceptions:

No.	Plate	Name
146865	25071	Arm Shaft (horizontal) with Needle Bar Crank and 1036AL, 140542AL and 140552AL, in place of 146651.....
146866	-----	Arm Shaft (horizontal) 146865 with 146581, in place of 146670
146878	-----	Combination of Feed and Stitch Regulator Parts, Nos. 143015, 146537, 146545, 146864, 146883, 146884, in place of 146913.....
146940	25085	Feed Dog, 13 teeth (10 teeth to the inch) for use with 146943, in place of 146008
146884	25071	Feed Lifting Eccentric with three 440AL, in place of 146914.....
26276	25085	Presser Foot Hinge Pin.....
131353	25085	Presser Foot Plate.....
160409	25085	Presser Foot Shank with 910AL and 51701J for 146946.....
910AL	25085	Presser Foot Shank Adjusting Screw
51701J	25085	Presser Foot Shank Adjusting Screw Nut..
146946	25085	Presser Foot (hinged) complete, Nos. 26276, 131353 and 160409, in place of 146029.....
146943	25085	Throat Plate for use with 146940, in place of 146033

FITTINGS FOR 253-11 MACHINE
For Plain Sewing For Medium Weight Fabrics

No.	Plate	Name
160618	25082	Edge Guide.....
922W	25082	Edge Guide Thumb Screw.....
146008	25082	Feed Dog, 10 teeth (10 teeth to the inch) ..
131256	25082	Presser Foot Hinge Pin.....
59262	25082	Presser Foot Knife.....
239C	25082	Presser Foot Knife Screw.....
146027	25082	Presser Foot Plate.....
146028	25082	Presser Foot Shank with 725J.....
725J	25082	Presser Foot Shank Adjusting Screw.....
146029	25082	Presser Foot (hinged) complete, Nos. 239C, 59262, 131256, 146027 and 146028.....
146033	25082	Throat Plate.....

For Pants Seaming

No.	Plate	Name
160618	25083	Edge Guide.....
922W	25083	Edge Guide Thumb Screw.....
160407	25083	Feed Dog, 15 teeth (12 teeth to the inch) ..
131256	25083	Presser Foot Hinge Pin.....
160408	25083	Presser Foot Plate.....
160409	25083	Presser Foot Shank with 910AL and 51701J
910AL	25083	Presser Foot Shank Adjusting Screw.....
51701J	25083	Presser Foot Shank Adjusting Screw Nut ..
160410	25083	Presser Foot (hinged) complete, Nos. 131256, 160408 and 160409.....
160411	25083	Throat Plate.....

For Glove Work

No.	Plate	Name
146925	25084	Edge Guide.....
51224W	25084	Edge Guide Thumb Screw.....
7071	25084	Edge Guide Thumb Screw Washer.....
160482	25084	Feed Dog, 9 teeth (10 teeth to the inch) ..
131256	25084	Presser Foot Hinge Pin.....
160483	25084	Presser Foot Plate.....
160484	25084	Presser Foot Shank with 50505J.....
50505J	25084	Presser Foot Shank Adjusting Screw.....
160493	25084	Presser Foot Thread Cutter.....
239C	25084	Presser Foot Thread Cutter Screw.....
160485	25084	Presser Foot (hinged) complete, Nos. 239C, 131256, 160483, 160484 and 160493.....
160486	25084	Throat Plate.....

FITTINGS FOR 253-12 MACHINE

**For Pants Seaming, Medium Heavy and
Heavy Weight Fabrics**

No.	Plate	Name
160618	25085	Edge Guide.....
922W	25085	Edge Guide Thumb Screw.....
146940	25085	Feed Dog, 13 teeth (10 teeth to the inch) ..
26276	25085	Presser Foot Hinge Pin.....
131353	25085	Presser Foot Plate.....
910AL	25085	Presser Foot Shank Adjusting Screw.....
51701J	25085	Presser Foot Shank Adjusting Screw Nut ..
160409	25085	Presser Foot Shank with 910AL and 51701J
146946	25085	Presser Foot (hinged) complete, Nos. 26276, 131353 and 160409.....
146943	25085	Throat Plate.....

**Fittings For
Binding, Seaming and Cording, For
Mattress Work, For No. 253-12 Machine**

No.	Plate	Name
160963	25086	Bed Slide (right) Body for 160964.....
160970	25086	Bed Slide (right) Body for 160971.....
146688	25075	Bed Slide (right) Latch.....
146689	25075	Bed Slide (right) Latch Guide.....
1470X	25075	Bed Slide (right) Latch Guide Screw (2)...
146690	25075	Bed Slide (right) Latch Spring.....
146691	25075	Bed Slide (right) Spring.....
1470X	25075	Bed Slide (right) Spring Screw (2).....
160964	-----	Bed Slide (right) complete, Nos. 146688, 146689, 146690, 146691, 160963 and four 1470X.....
160971	-----	Bed Slide (right) complete, Nos. 146688, 146689, 146690, 146691, 160970 and four 1470X.....
160965	25086	Bed Slide (right) with Binder Holder and Ribbon Tension complete, for binding mattresses, Nos. 1443J, 25717, 160964, 160966 and four each 201J and 7071.....
160972	25086	Bed Slide (right) with Edge Guide and Throat Plate Fill-in Plate complete, for seaming mattresses, Nos. 793W, 7071, 50156C, 160971, 160973 and 160974.....
160966	25086	Binder Holder.....
201J	25086	Binder Holder Screw (2).....
7071	25086	Binder Holder Screw Washer (2).....
201J	-----	Binder Screw (2).....
7071	-----	Binder Screw Washer (2).....
26614	25086	Binder Ribbon Tension Pin (bent).....
26615	25086	Binder Ribbon Tension Pin (straight) (4) ..
26616	25086	Binder Ribbon Tension Plate.....

No.	Plate	Name
1443J	25086	Binder Ribbon Tension Plate Screw.....
25717	----	Binder Ribbon Tension complete, Nos. 26614, 26616 and four 26615.....
160973	25086	Edge Guide
793W	25086	Edge Guide Thumb Screw.....
7071	25086	Edge Guide Thumb Screw Washer
131361	25086	Feed Dog, 15 teeth (12 teeth to the inch) coarse
54249	25086	Feed Dog, 20 teeth (16 teeth to the inch) fine
146071	25086	Looper
146072	25086	Looper 146071 with 229J and 146073.....
146073	25086	Looper Needle Guard with 46105
46105	25086	Looper Needle Guard Pin.....
229J	25086	Looper Needle Guard Screw
68140	25086	Presser Foot Hinge Pin.....
906AL	25086	Presser Foot Hinge Pin Set Screw.....
131349	25086	Presser Foot Knife.....
239C	25086	Presser Foot Knife Screw.....
160967	25086	Presser Foot Plate with 906AL
160968	25086	Presser Foot Shank with 442AL and 1695X ..
442AL	25086	Presser Foot (adjusting) Screw
1695X	25086	Presser Foot (adjusting) Screw Nut
160969	25086	Presser Foot (hinged) with Knife complete, Nos. 239C, 68140, 131349, 160967 and 160968
160975	25086	Presser Foot with Cord Groove.....
146060	25086	Throat Plate
160974	25086	Throat Plate Fill-in Plate
50156C	25086	Throat Plate Fill-in Plate Screw.....

SET OF FITTINGS COMPLETE NO. 160702

for 1/2 in. to 1 in. binding, in steps of 1/16 in., for binding
slip covers and mattresses for Nos. 253-11 and 253-12 Machines

No.	Plate	Name
146061	25087	Bed Slide (right, latch type).....
146688	25075	Bed Slide (right) Latch
146689	25075	Bed Slide (right) Latch Guide
1470X	25075	Bed Slide (right) Latch Guide Screw (2)....
146690	25075	Bed Slide (right) Latch Spring
146691	25075	Bed Slide (right) Spring.....
1470X	25075	Bed Slide (right) Spring Screw (2).....
146062	25087	Bed Slide (right, latch type) complete, Nos. 146061, 146688, 146689, 146690, 146691 and four 1470X.....

No.	Plate	Name
160699	25087	Binder (English).....
26614	25087	Binder Ribbon Tension Pin (bent).....
26615	25087	Binder Ribbon Tension Pin (straight) (4) ..
26616	25087	Binder Ribbon Tension Plate
1443J	25087	Binder Ribbon Tension Plate Screw.....
25717	----	Binder Ribbon Tension complete, Nos. 26614, 26616 and four 26615
203J	25087	Binder Screw.....
7071	25087	Binder Screw Washer
160700	25087	Binder Throw-out Arm with 43525.....
43525	25087	Binder Throw-out Arm Position Stud.....
916C	25087	Binder Throw-out Arm Tension Screw Stud
44209	----	Binder Throw-out Arm Tension Screw Stud 916C with 1560C.....
1560C	25087	Binder Throw-out Arm Tension Screw Stud Nut.....
2103	25087	Binder Throw-out Arm Tension Spring....
160701	25087	Binder (English) on Throw-out Arm and... Bed Slide (right) complete, Nos. 203J, 1443J, 2103, 7071, 25717, 44209, 146062, 160699 and 160700
		NOTE: When ordering No. 160701, finished sample must be submitted or size of tape stated.
131361	25087	Feed Dog, 15 teeth (12 teeth to the inch) coarse.....
54249	25087	Feed Dog, 20 teeth (16 teeth to the inch) fine
		NOTE: Feed Dog (coarse) No. 131361 is regularly furnished with this set of fittings unless Feed Dog (fine) No. 54249 is specified.
26276	25087	Presser Foot Hinge Pin
146063	25087	Presser Foot Plate
146064	25087	Presser Foot Shank.....
146065	25087	Presser Foot (hinged) complete, Nos. 26276, 146063 and 146064.....
146060	25087	Throat Plate
160702	25087	Set of Fittings complete, Nos. 54249 or 131361, 146060, 146065 and 160701.....

SET OF FITTINGS COMPLETE NO. 161032

for joining shoulders on shirts for
Nos. 253-11 and 253-12 Machines

No.	Plate	Name
161020	25088	Bed Slide (right).....
146525	25088	Bed Slide (right) Knob.....
146524	25075	Bed Slide (right) Spring
1423X	25075	Bed Slide (right) Spring Screw
240C	25075	Bed Slide (right) Spring Stop Screw (2)....
161021	25088	Bed Slide (right) complete, Nos. 1423X, 146524, 146525, 161020 and two 240C...
161023	25088	Feed Dog, 17 teeth (16 teeth to the inch) ..
161022	25088	Joining Attachment with two 1443J.....

No.	Plate	Name
1443J	25088	Joining Attachment Edge Folder Edge Guide Screw (2).....
1423J	25088	Joining Attachment Screw (2).....
161025	25088	Presser Foot Plate (right).....
18055	25088	Presser Foot Plate Hinge Pin.....
161024	25088	Presser Foot Shank.....
161026	25088	Presser Foot Yielding Plate (left).....
8282	25088	Presser Foot Yielding Plate (left) Spring ..
161027	25088	Presser Foot (hinged) with left hand Yielding Plate complete, Nos. 8282, 18055, 161024, 161025 and 161026.....
161028	25088	Throat Plate.....
161032	25088	Set of Fittings complete, Nos. 161021, 161022, 161023, 161027, 161028 and two 1423J.....

NOTE: Two No. 1423J are used to fasten Attachment No. 161022 to Bed Slide No. 161021.

SET OF FITTINGS COMPLETE NO. 161033

for Yoke setting on back of shirts
for Nos. 253-11 and 253-12 Machines

No.	Plate	Name
146523	25089	Bed Slide (right).....
146525	25089	Bed Slide (right) Knob.....
146524	25075	Bed Slide (right) Spring.....
1423X	25075	Bed Slide (right) Spring Screw.....
240C	25075	Bed Slide (right) Spring Stop Screw (2).....
146526	25089	Bed Slide (right) complete, Nos. 1423X, 146523, 146524, 146525 and two 240C....
161030	25089	Feed Dog, 13 teeth (12 teeth to the inch)....
161025	25089	Presser Foot Plate (right).....
18055	25089	Presser Foot Plate Hinge Pin.....
161024	25089	Presser Foot Shank.....
161026	25089	Presser Foot Yielding Plate (left).....
8282	25089	Presser Foot Yielding Plate (left) Spring ..
161027	25089	Presser Foot (hinged) with left hand Yielding Plate complete, Nos. 8282, 18055, 161024, 161025 and 161026.....
161031	25089	Throat Plate.....
161029	25089	Yoking Attachment on Shank.....
		NOTE: When ordering No. 161029, state size of edge fold required.
1499J	25089	Yoking Attachment Screw (2).....
161033	25089	Set of Fittings complete, Nos. 146526, 161027, 161029, 161030, 161031 and two 1499J.....

NOTE: Two No. 1499J are used to fasten Attachment No. 161029 to Machine Bed.

ACCESSORIES

No.	Plate	Name
146637	25015	Machine Base and Oil Reservoir.....
146638	25015	Machine Base and Oil Reservoir 146637 with 146639, 146693, 146695 and two 146640 (for Agents only).....
146639	25015	Machine Base and Oil Reservoir Gasket (felt).....
146693	25015	Machine Base and Oil Reservoir Oil Return Wick.....
146695	25015	Machine Base and Oil Reservoir Oil Return Wick Position Pad (felt).....
143308	25090	Machine Cushion (felt) (4).....
12361	25090	Machine Hinge Connection (2).....
146640	25015	Machine Pad (felt) (2).....
41400	25090	Machine Rest Pin (wood).....
120344	25090	Oiler with 120345.....
120345	25090	Oiler Spout.....
121741	25090	One Quart Can of Light Grade Stainless Oil
120440	25090	Screw Driver.....
121108	25090	Screw Driver.....
120341	25090	Tweezers (curved).....
8908	25090	Wrench.....
23535	25090	Wrench.....
42850	25090	Wrench.....
146057	25090	Wrench (socket) for 140552AL.....
151281	25090	Wrench (socket).....

BELT GUARD (HINGED) COMPLETE

No.	Plate	Name
151362	25091	Belt Guard Bottom Section with 2273 and 140321C.....
151363	25091	Belt Guard Top Section with 151366 and two 219R.....
151366	25091	Belt Guard Top Section Fill-in Plate.....
219R	25091	Belt Guard Top Section Fill-in Plate Screw (2).....
151364	25091	Belt Guard Top Section Hinge Pin.....
140321C	25091	Belt Guard Top Section Hinge Pin Set Screw
151365	25091	Belt Guard Top Section Lock Spring.....
2273	25091	Belt Guard Top Section Lock Spring Position Pin.....
217E	25091	Belt Guard Top Section Lock Spring Screw
151367	25091	Belt Guard (hinged) complete, Nos. 217E, 151362, 151363, 151364, 151365 and two wood Screws 1 1/4 in. No. 12 F.H.B....

NOTE: No. 151367 is furnished only when ordered.

FACE PLATE THREAD LUBRICATOR

No.	Plate	Name
146810	25051	Thread Lubricator Adaptor.....
140224J	25051	Thread Lubricator Adaptor Screw.....
7071	25051	Thread Lubricator Adaptor Screw Washer .
241755	25051	Thread Lubricator Oil Pad (felt).....
146806	25051	Thread Lubricator Oil Pad Holder.....
146807	-----	Thread Lubricator Oil Pad Holder 146806 with 62827, 240439 and 241755.....
240439	25051	Thread Lubricator Oil Pad Retainer.....
17822	25051	Thread Lubricator Oil Reservoir Rivet....
8068	25051	Thread Lubricator Oil Reservoir Rivet Washer (inside).....
124371	25051	Thread Lubricator Oil Reservoir Rivet Washer (outside).....
62827	25051	Thread Lubricator Oil Wick.....
146808	-----	Thread Lubricator complete, Nos. 8068, 17822, 124371 and 146807.....
146809	25051	Thread Lubricator 146808 with 7071, 21202, 50222J, 140224J and 146810.....
50222J	25051	Thread Lubricator Screw.....
21202	25051	Thread Lubricator Screw Washer.....

FOOT LIFTER PARTS

No.	Plate	Name
6439	-----	Chain, 36 in. to 45 in., with 56864 and 56865.....
NOTE: When ordering No. 6439, state length required.		
4879	25030	Chain Connecting Link.....
56864	-----	Chain Hook (large).....
56865	-----	Chain Hook (small).....
126249	25030	Treadle.....
4882	25030	Treadle Shaft.....
126250	25030	Treadle Spring.....
150451	25030	Treadle Stand.....
150452	25030	Treadle complete, Nos. 4879, 4882, 126249, 126250, 150451 and two wood screws 1 in. No. 16 F.H.....

KNEE LIFTER PARTS

No.	Plate	Name
146764	25030	Chain, length 10 1/4 in., with 46865 and 56865.....
56865	25030	Chain Hook.....

No.	Plate	Name
46865	25030	Chain Link.....
146765	25030	Rock Shaft.....
146766	25030	Rock Shaft Hanger with two wood screws 1 in. No. 10 F.H. (2).....
143283	25030	Rock Shaft Knee Arm.....
143285	-----	Rock Shaft Knee Arm complete, Nos. 2767, 143283 and 143284.....
143284	25030	Rock Shaft Knee Arm Hub with 356C and 140351AL.....
140351AL	25030	Rock Shaft Knee Arm Hub Clamping Screw
356C	25030	Rock Shaft Knee Arm Hub Set Screw.....
2767	25030	Rock Shaft Knee Arm Plate with 356C....
356C	25030	Rock Shaft Knee Arm Plate Set Screw....
6337	25030	Rock Shaft Lifting Bracket with two 356C..
7125	25030	Rock Shaft Lifting Bracket Hook.....
356C	25030	Rock Shaft Lifting Bracket Hook Set Screw
356C	25030	Rock Shaft Lifting Bracket Set Screw.....
146768	25030	Rock Shaft Spring.....
1115AL	25030	Rock Shaft Spring Screw.....
146769	25030	Rock Shaft Stop Dog (back) with 140351AL.
146770	25030	Rock Shaft Stop Dog (front) with 140351AL
140351AL	25030	Rock Shaft Stop Dog Clamping Screw (2) ..
146771	25030	Rock Shaft complete, Nos. 1115AL, 6337, 7125, 143285, 146765, 146768, 146769, 146770 and two 146766.....
146779	25030	Knee Lifter complete, Nos. 146764 and 146771.....

THREADUNWINDER FOR TWO SPOOLS

No.	Plate	Name
151032	25092	Base with 138R and three wood screws 1 in. No. 12 F.H.....
228764	25092	Spool Pin (2).....
228766	25092	Spool Rest with 201254C.....
151108	25092	Spool Rest Bracket.....
151034	25092	Spool Rest Bracket Rod.....
138R	25092	Spool Rest Bracket Rod Set Screw.....
150203	25092	Spool Rest Cushion (felt) (2).....
1395R	25092	Spool Rest Screw.....
201254C	-----	Spool Rest Set Screw.....
151035	25092	Thread Guide (2).....
1521R	25092	Thread Guide Nut (4).....
9525	25002	Thread Guide Nut Washer (4).....
151109	25092	Thread Unwinder complete for two spools, Nos. 1395R, 151032, 151034, 151108, 228766, two 150203, 151035, 228764, and four each 1521R and 9525R.....

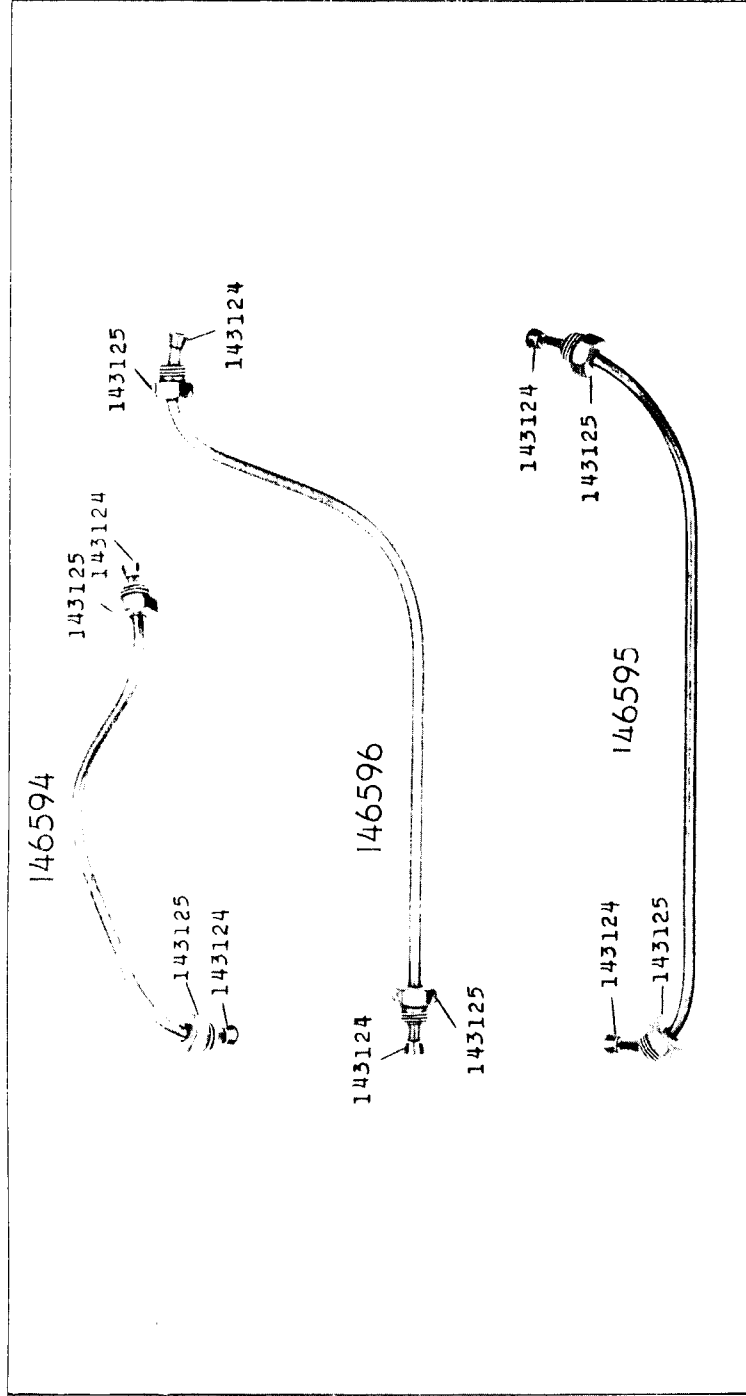

25015 - 1/3

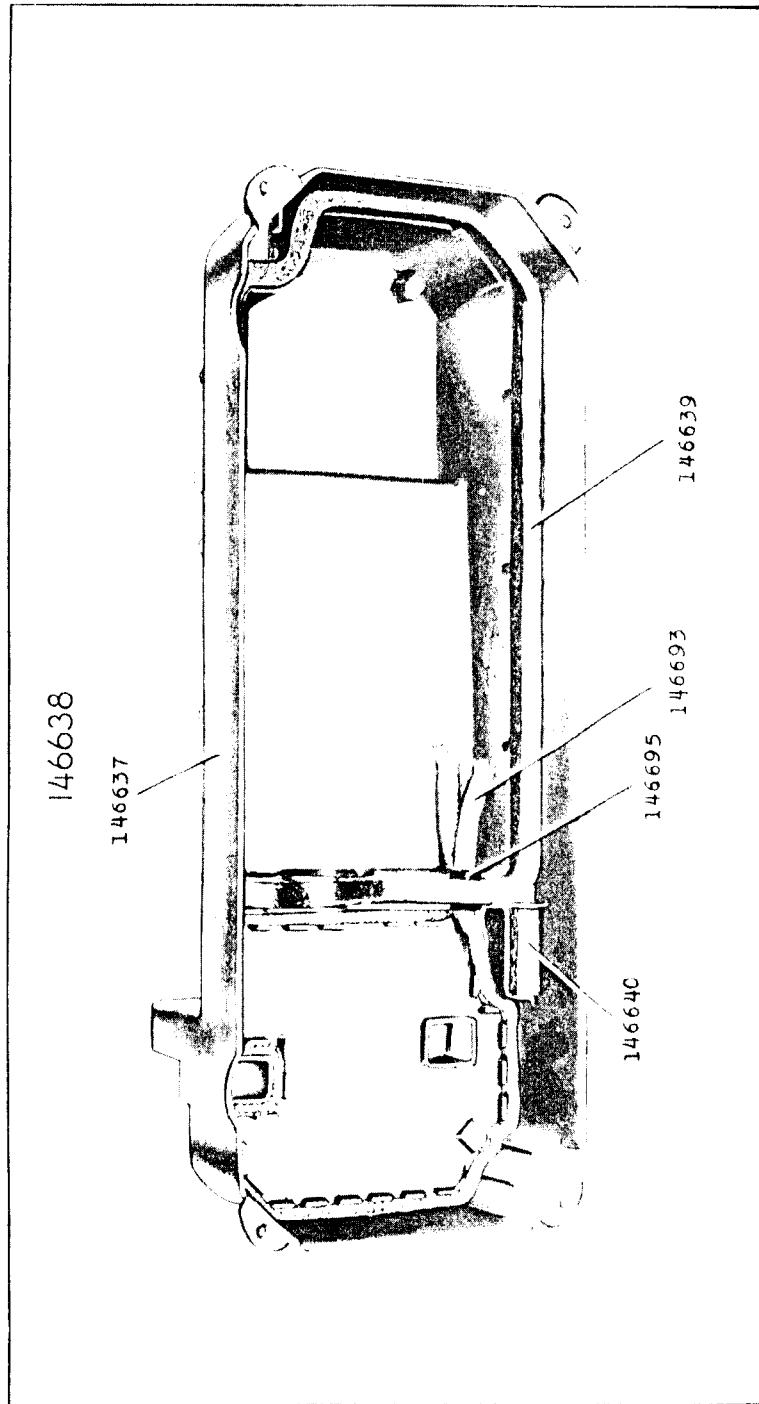

25030 - 1/4

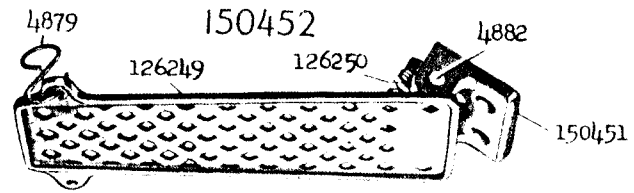

146779

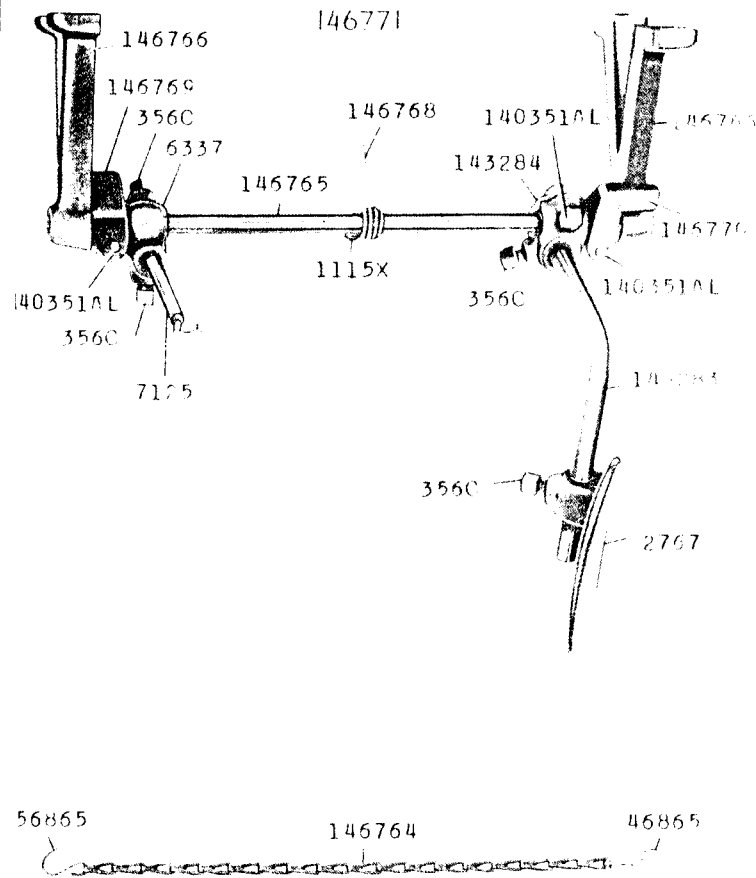

25037-1/2

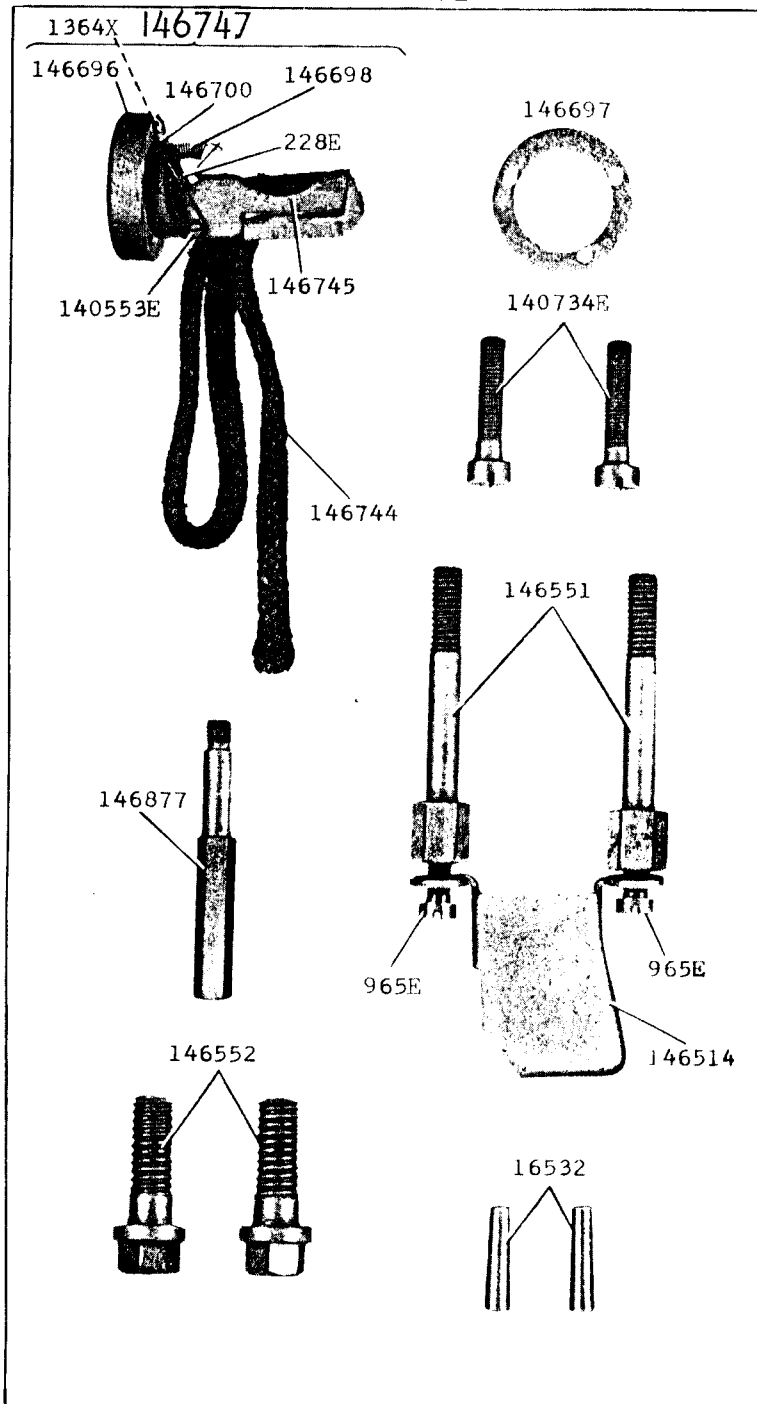

25041-1/2

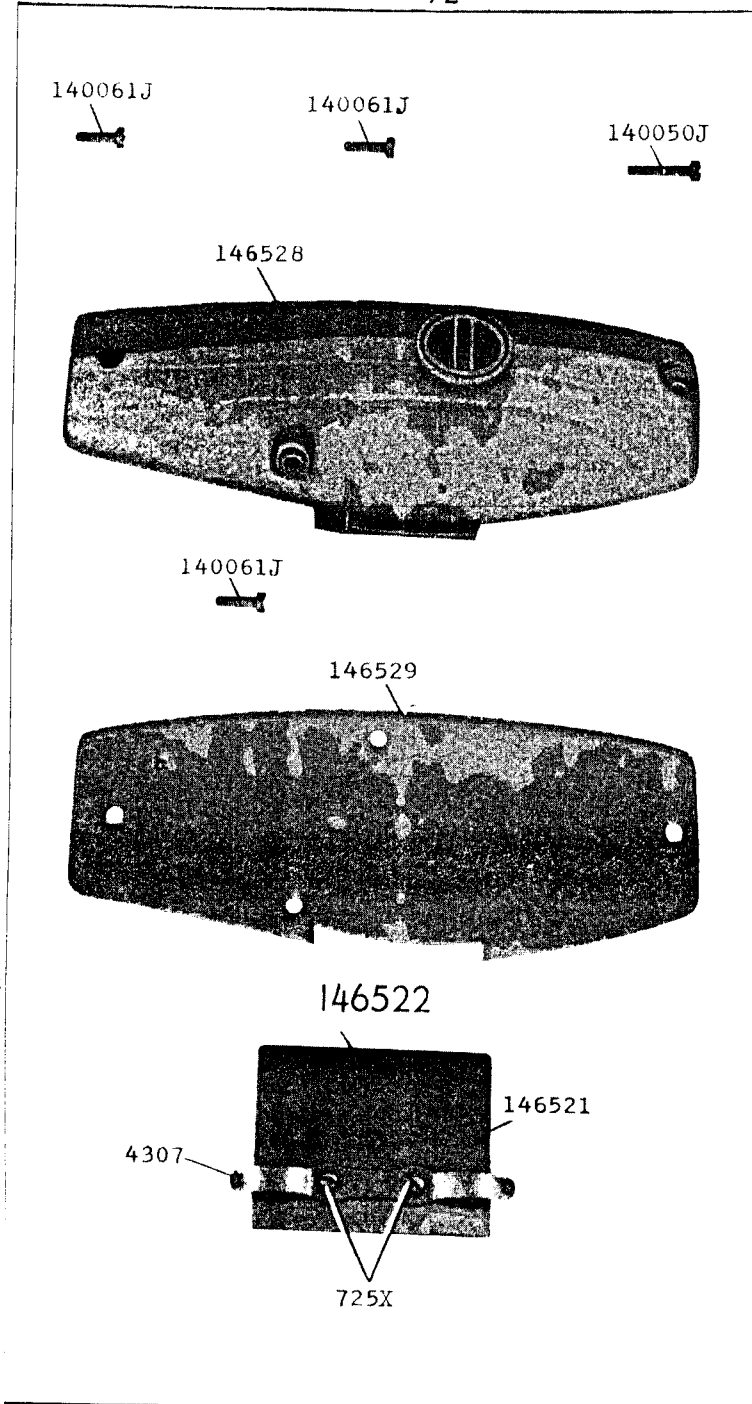

PLATE 12319 - FULL SIZE

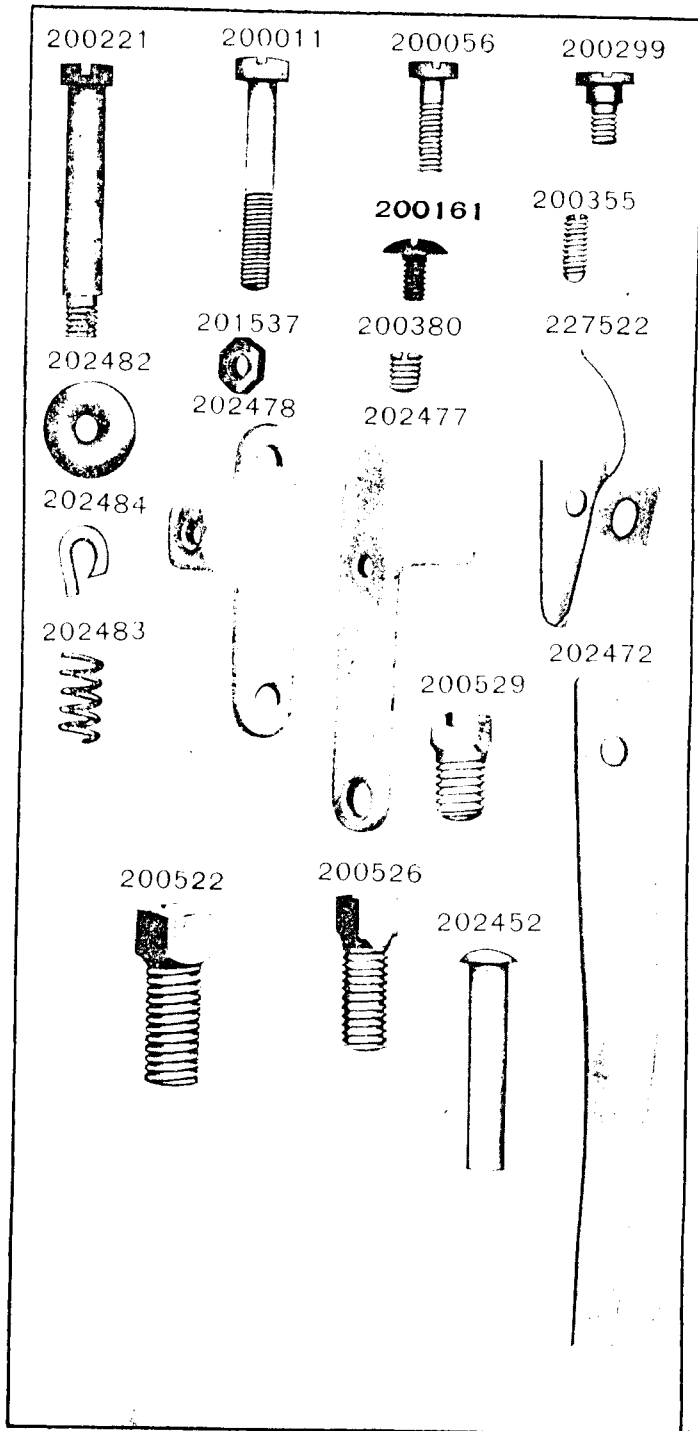
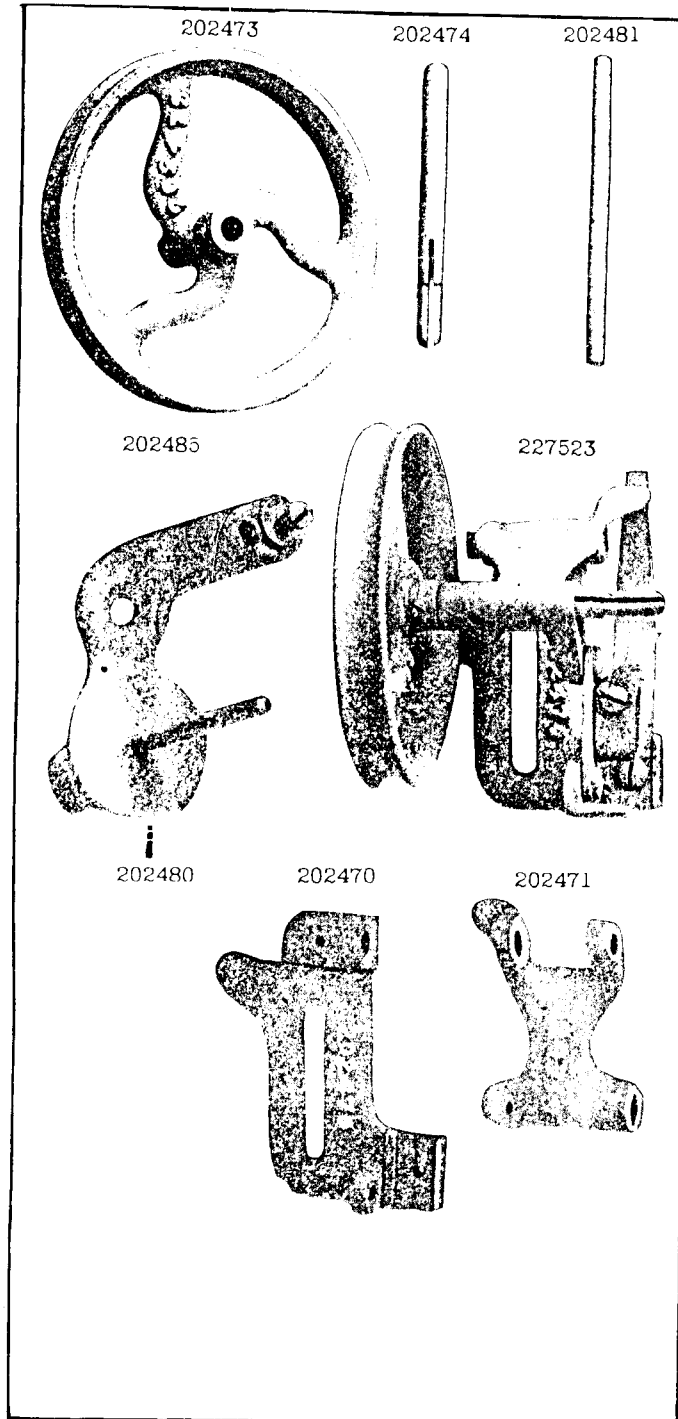
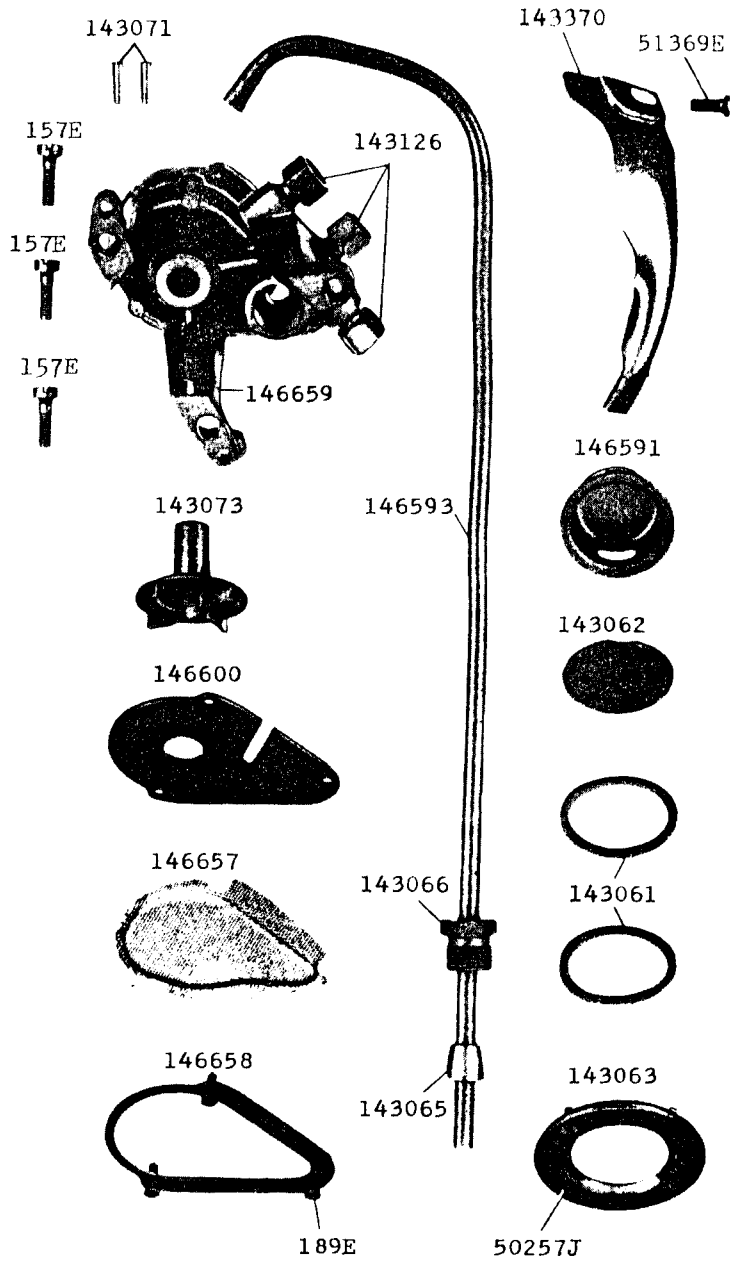

PLATE 12320 - ONE-HALF SIZE



25046-1/2

146597



25047-2/3

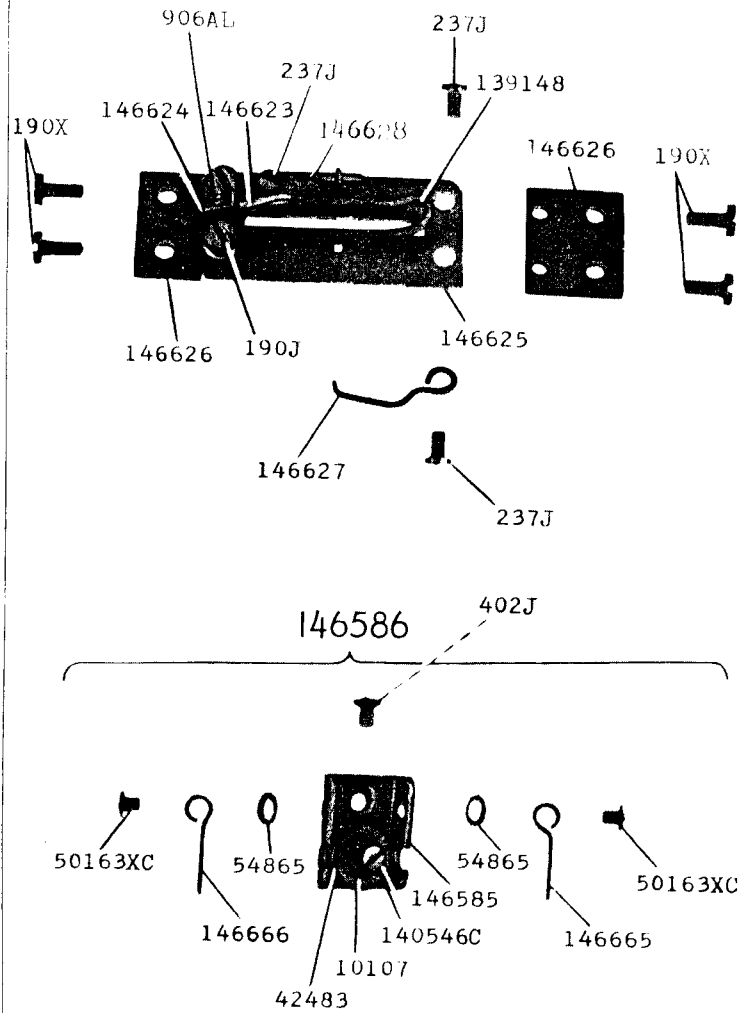

25051-1/2

25070-1/3

146809

50222J

21202

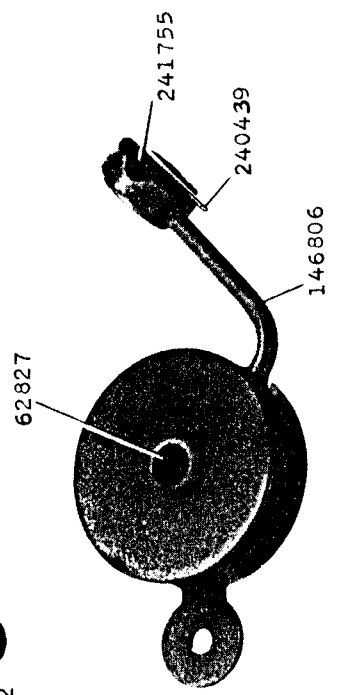

62827

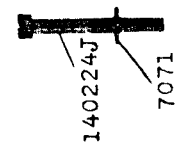

146810



17822

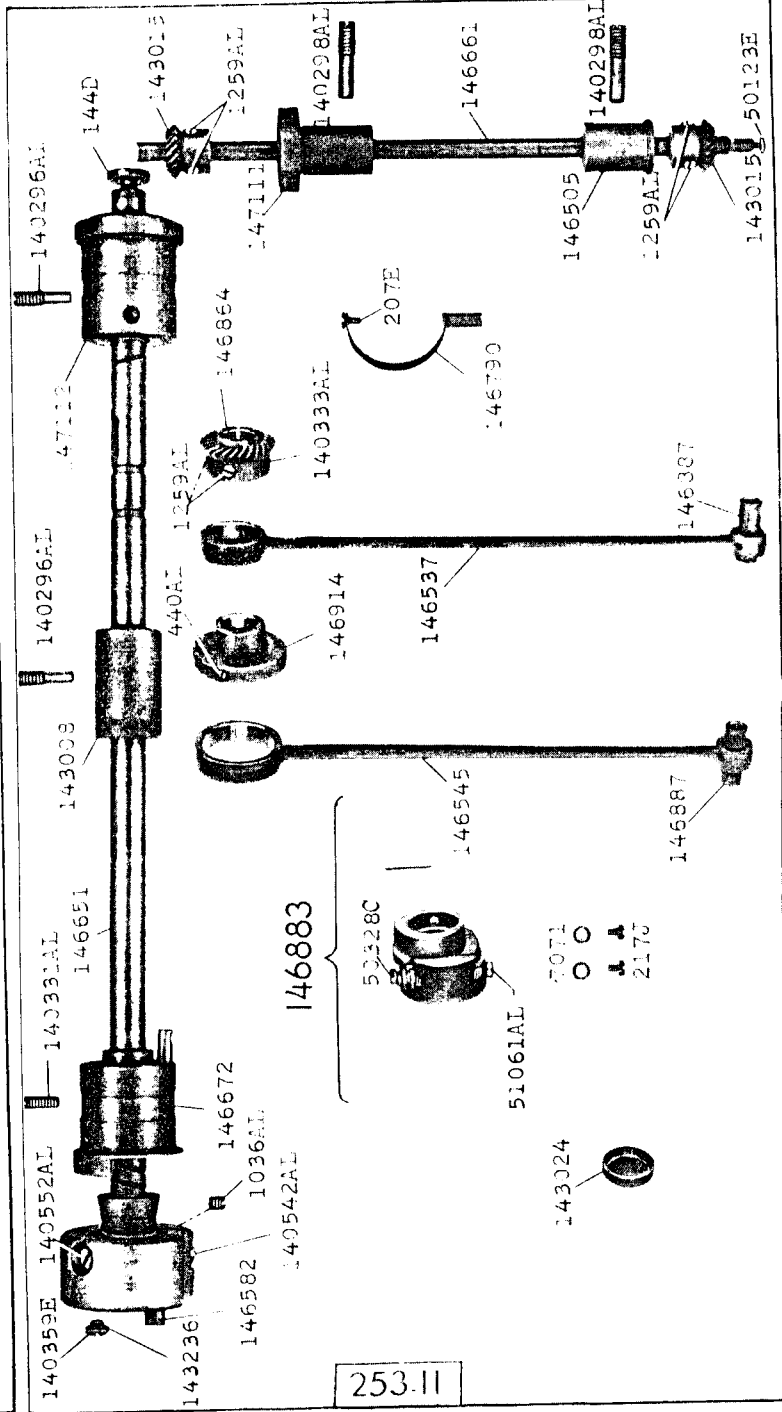

25071.1/3

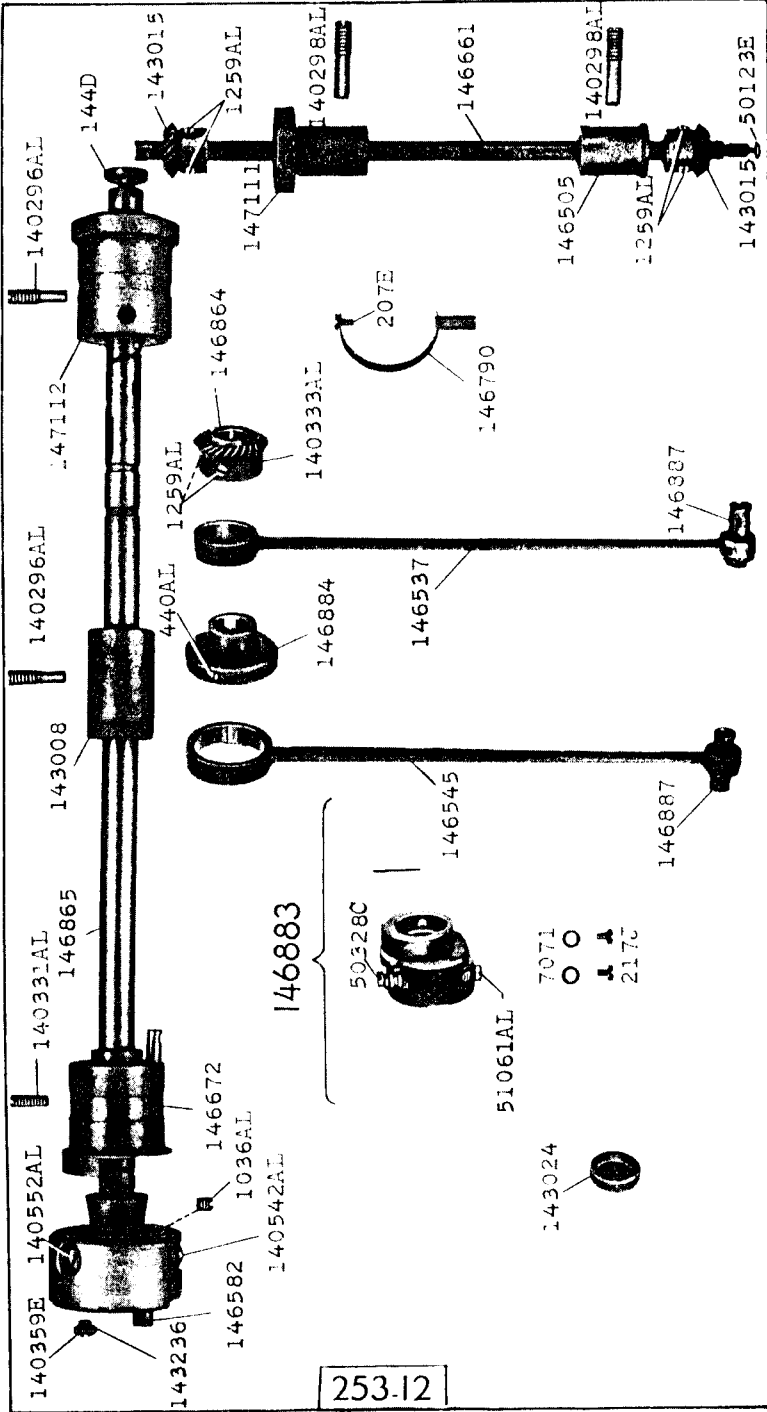

253.12

25072.1/3

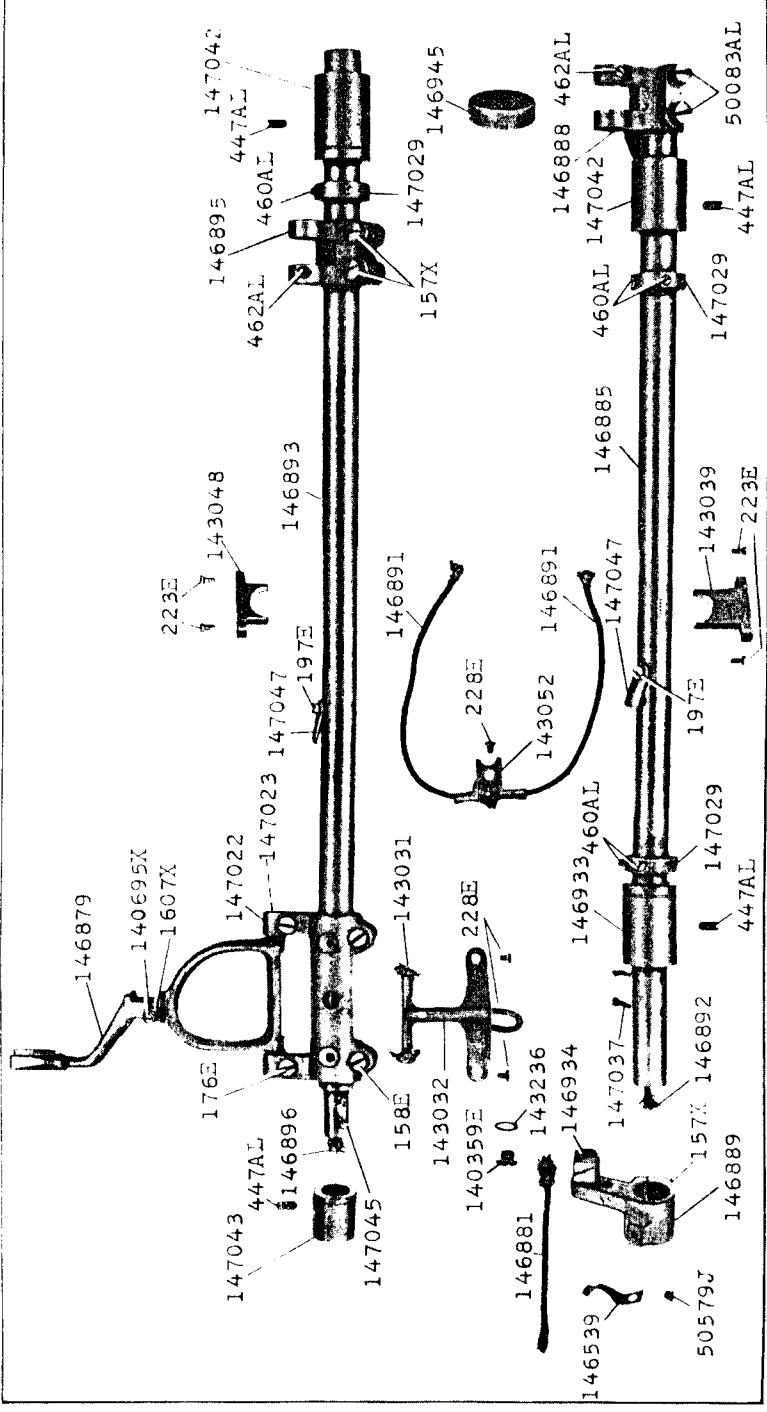

25073.1/3

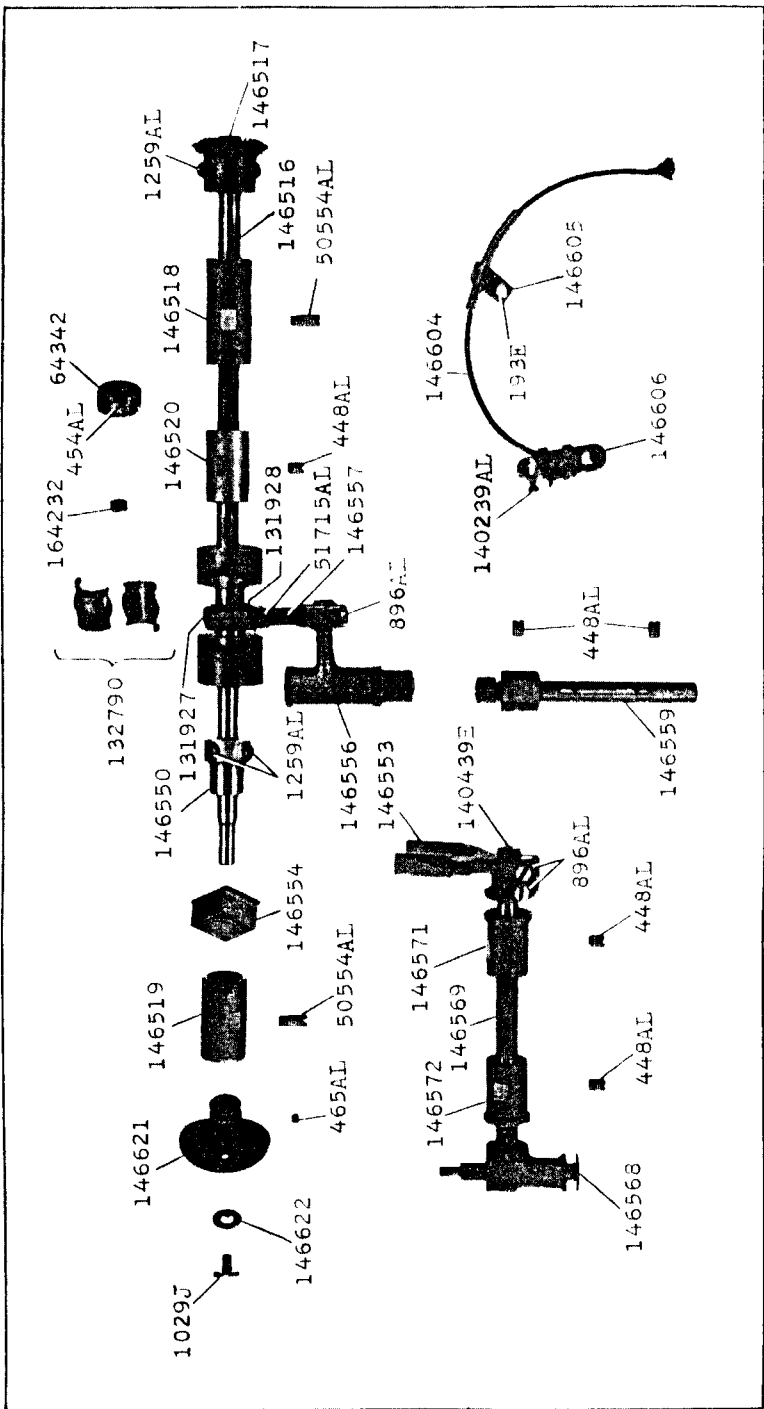

25074.1/2

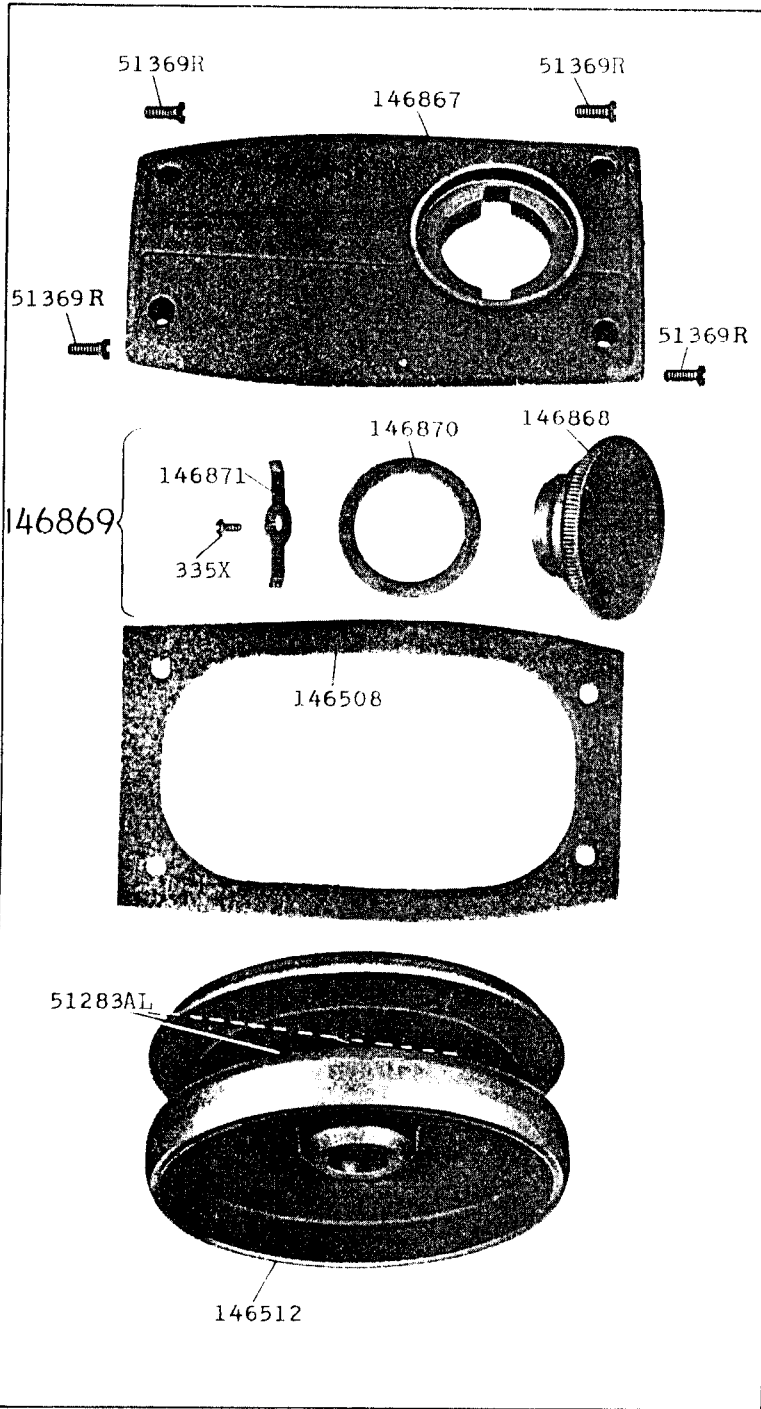

PLATE 13411—ONE-HALF SIZE

213791



203306



213260



213804



213188

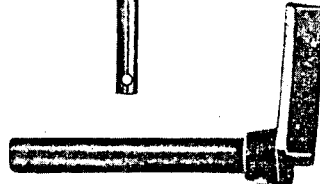

221472

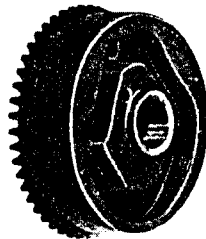

215697

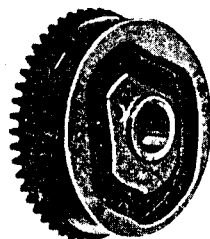

203268

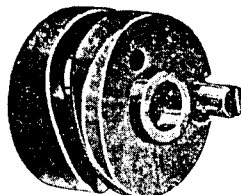

PLATE 13412—ONE-HALF SIZE

204251



227448



213203



213191

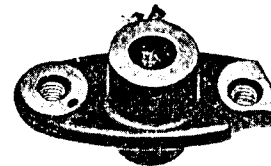

203321

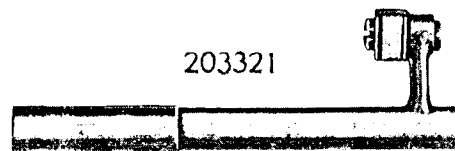

227442



25075.1/2

146007

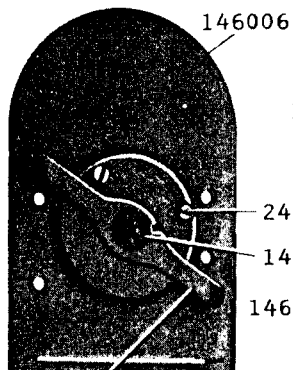

146062

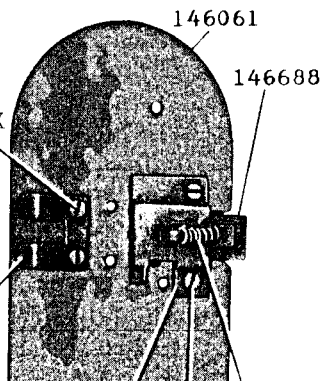

146524 146873

146872

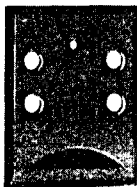

146874



51282X

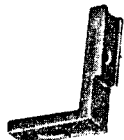

146743

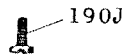

190J

146939



176J



146742



190J



25076.1/2

146805

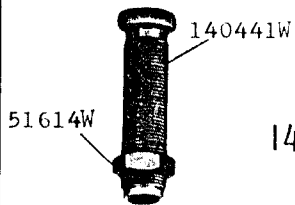

51614W

140440X

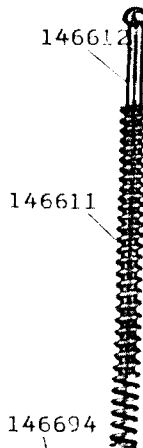

146694

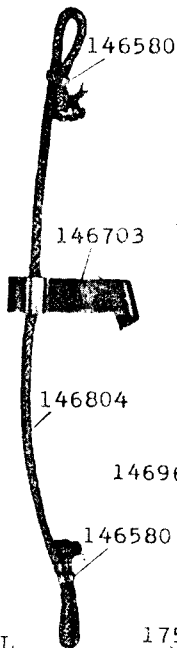

146960

146580

146751

1057AI

1133E

190J

146752

139462

190J

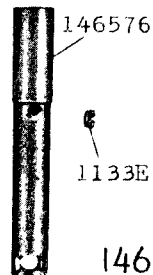

1133E

146042

146032

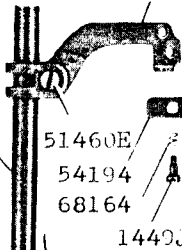

51460E

54194

68164

1449J

175E

139110

146908

139111

139111

146959

140239AL

SS329E

146962

50579X

25077-1/2

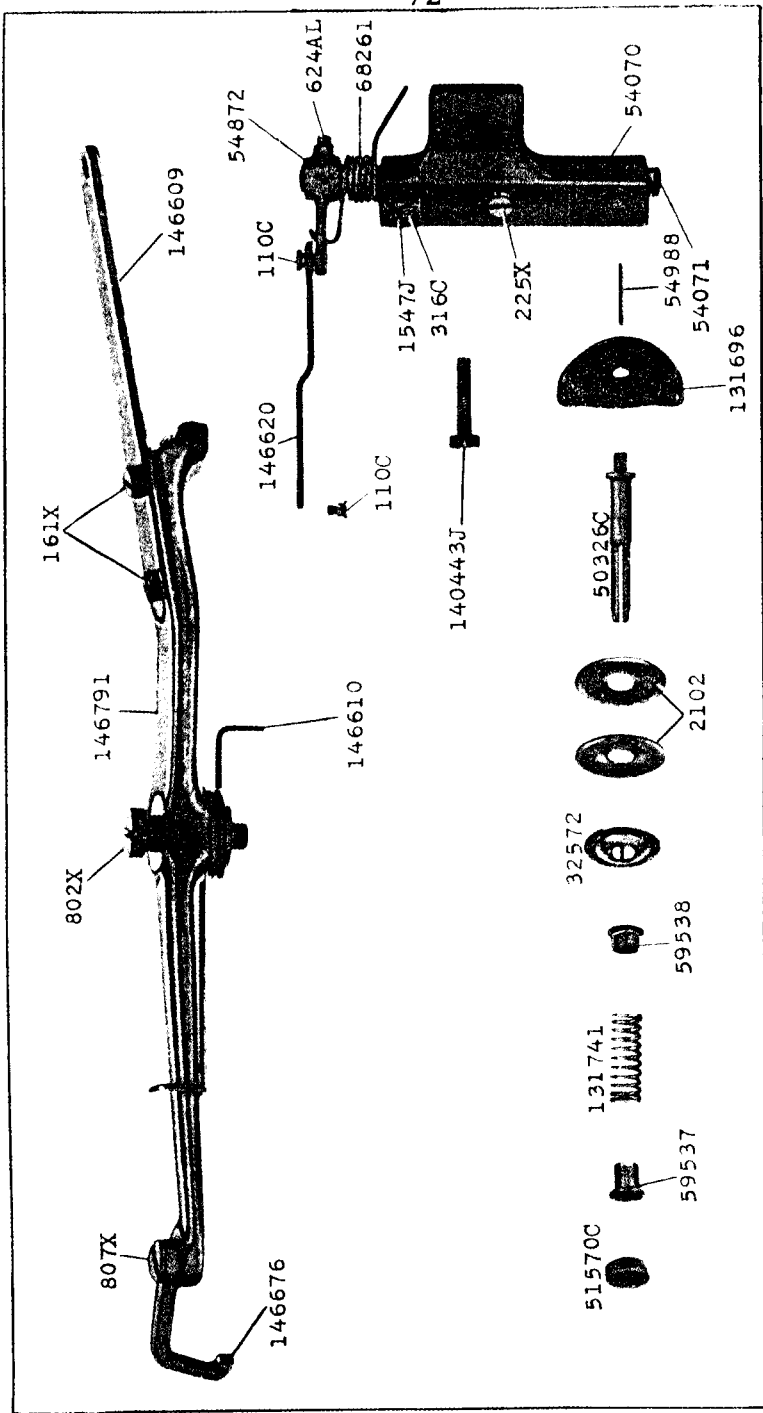

25078-1/2

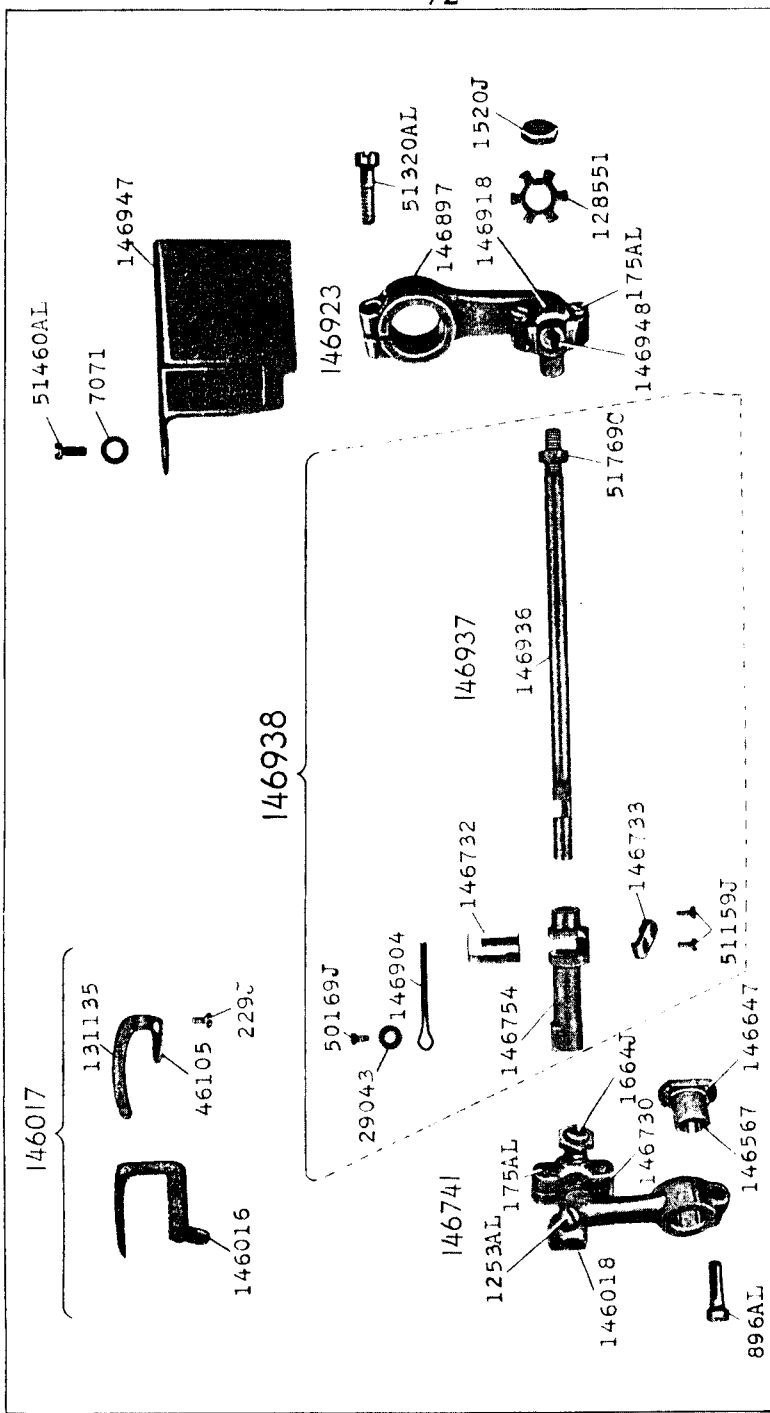

25079.1/2

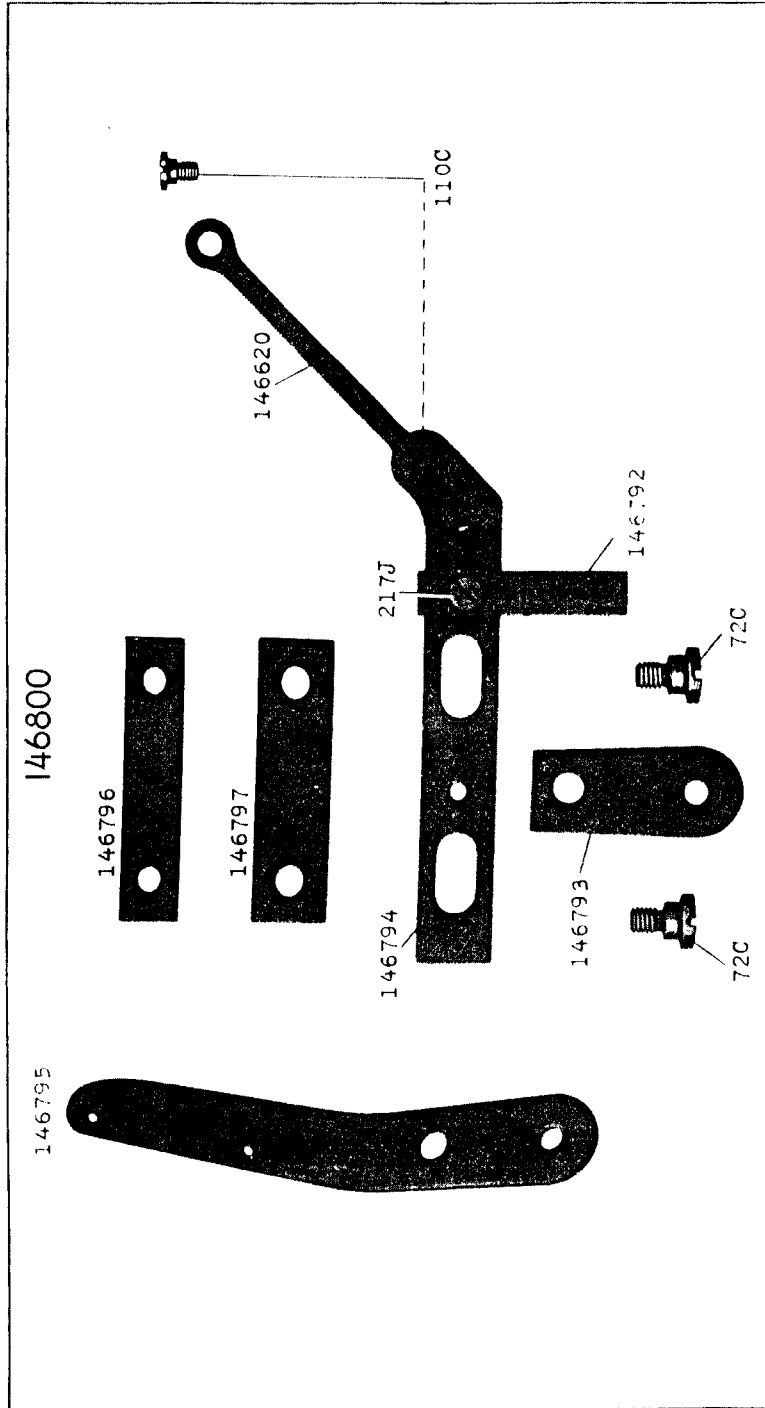

25080.1/2

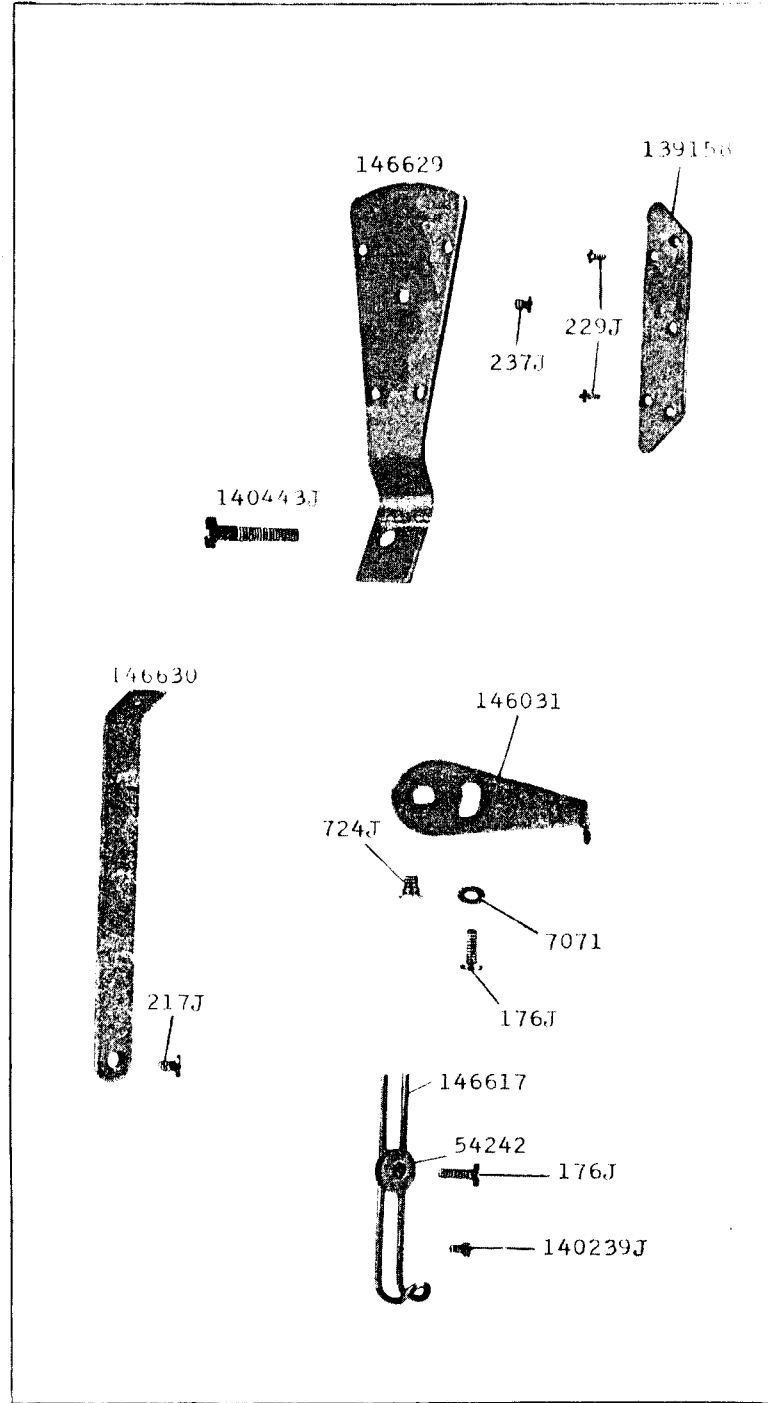

25081-1/2

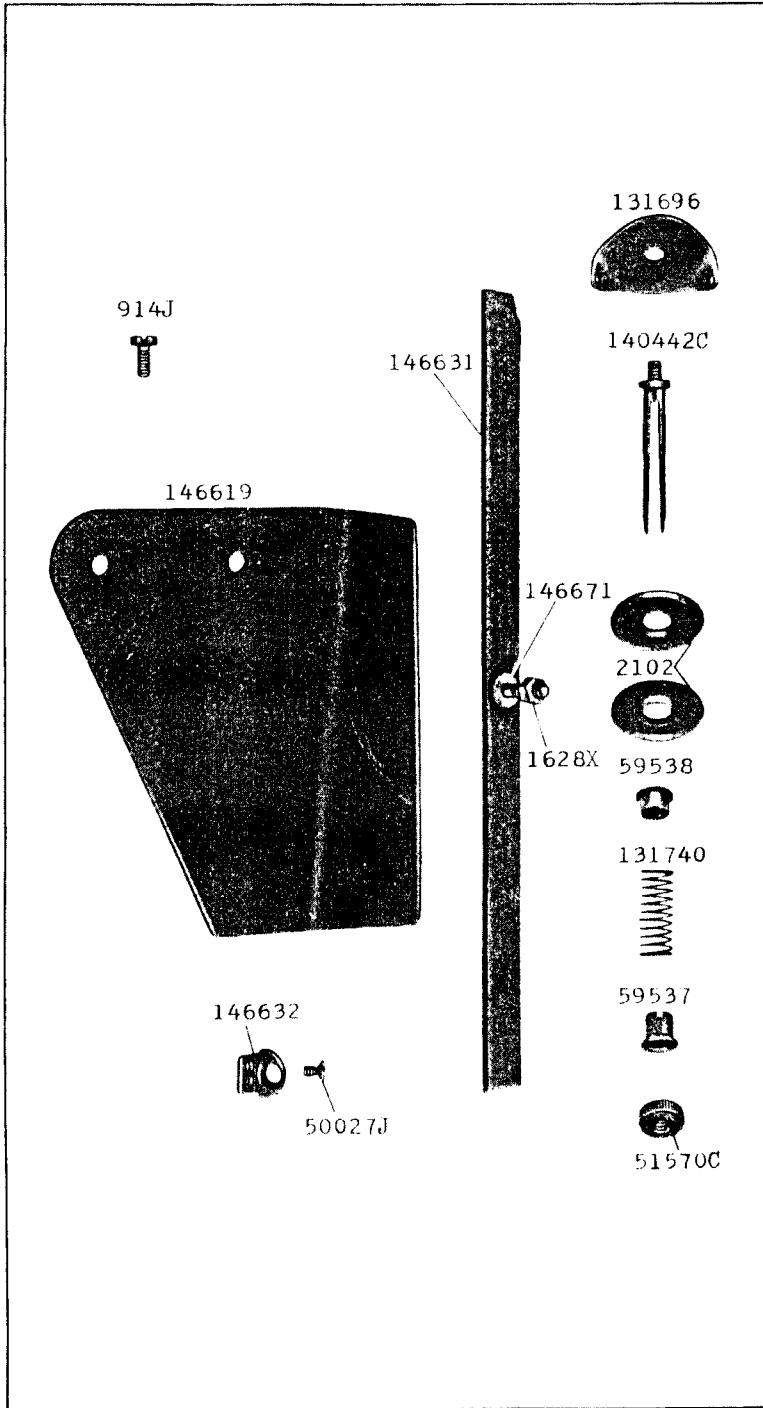

25082 2/3

253 II

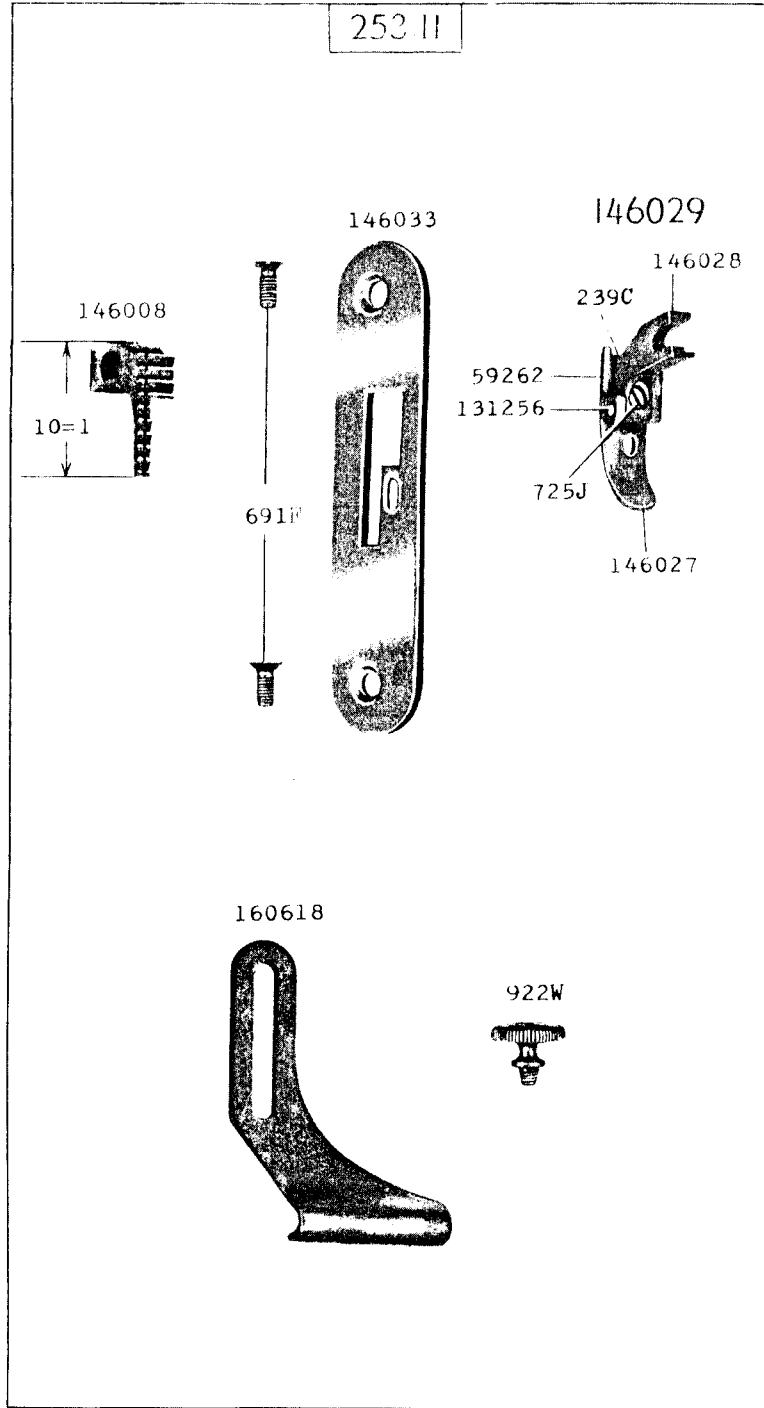

25083.2/3

253.II

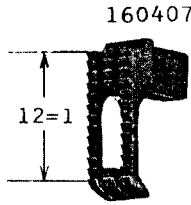

160407

12=1



160411

160410

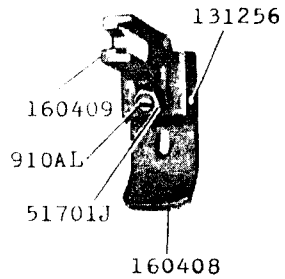

160409
910AL
51701J

131256

160408

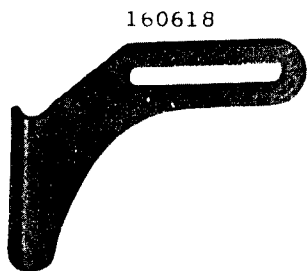

160618



922W

25084.2/3

253.II

24I4

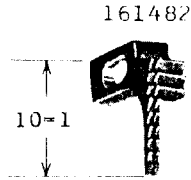

161482

10=1



160486

160485

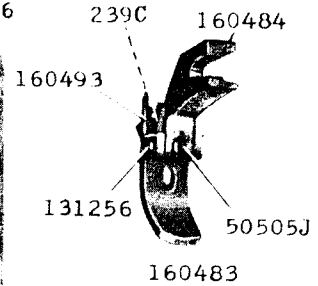

239C

160484

160493

131256

50505J

160483



146925



51224W

7071

25085.2/3

253.12

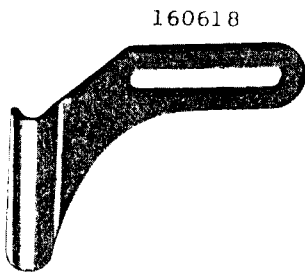
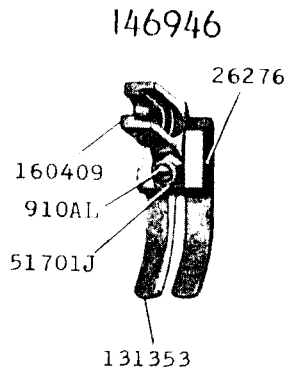
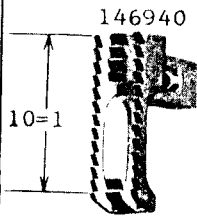

25086.1/2

253.12

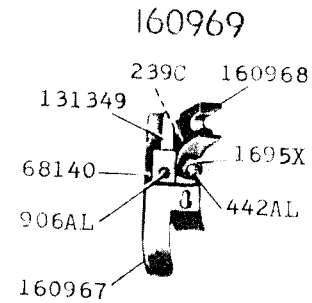
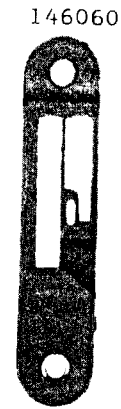
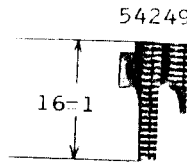
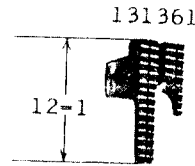

160972

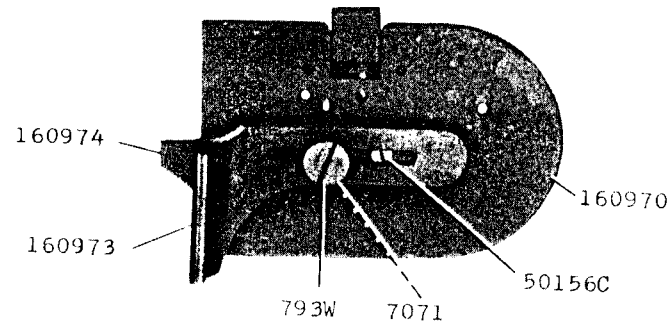

160965

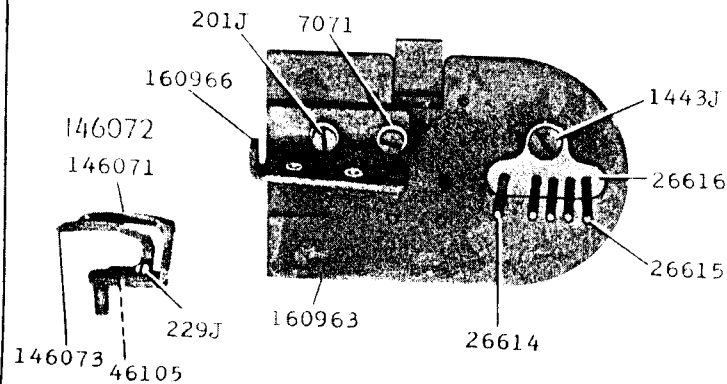

25087-1/2

160702

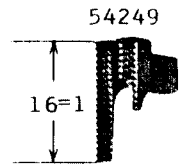

146065

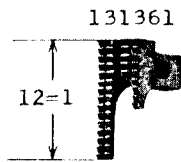
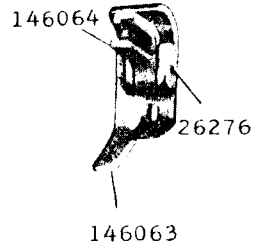

160701

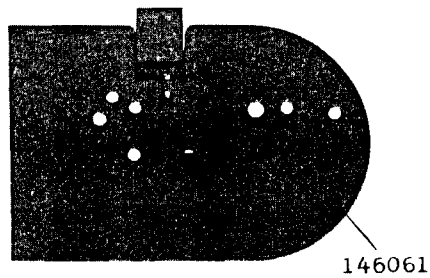
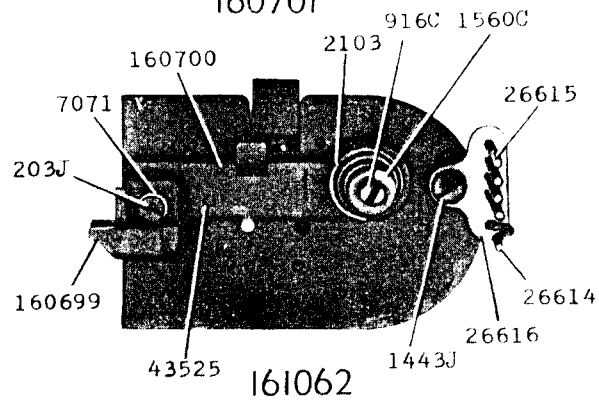

25088-1/2

161032

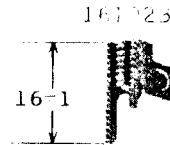

161027

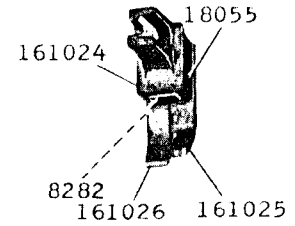

161021

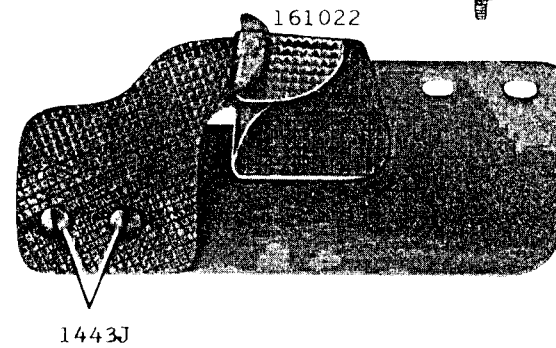
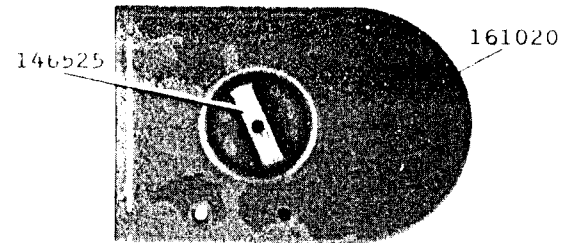

25089.1/2

161033

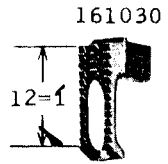

12-1

161031



161027

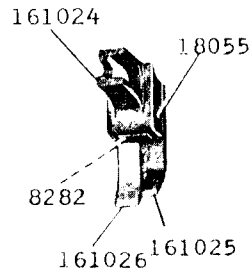

146526

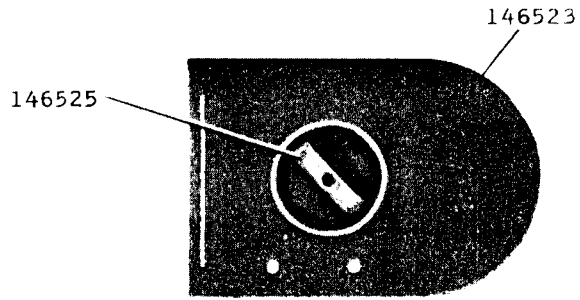

161029

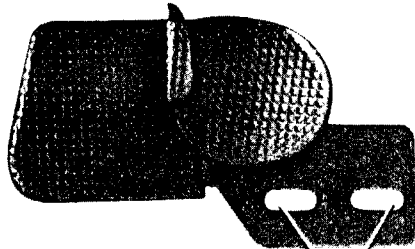

1499J

25090 1/2

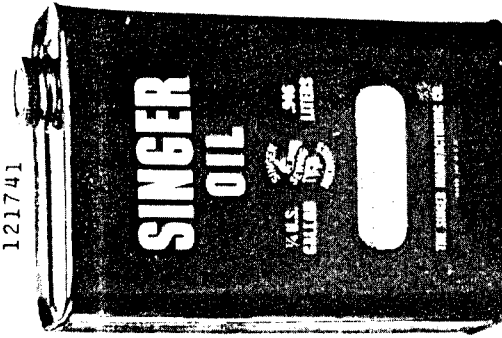

121741



120440

121108



42850



23535



8908

151281

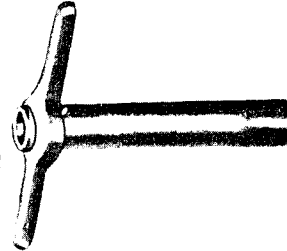

146057

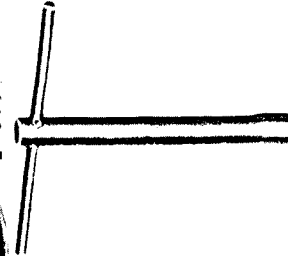

120344

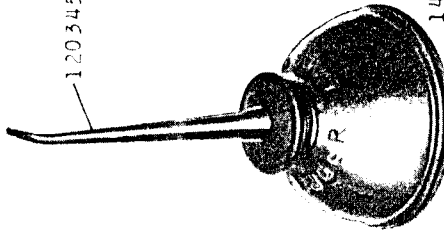

120345

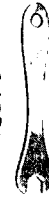

120341

41400

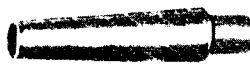

143308



12361



25091 1/8

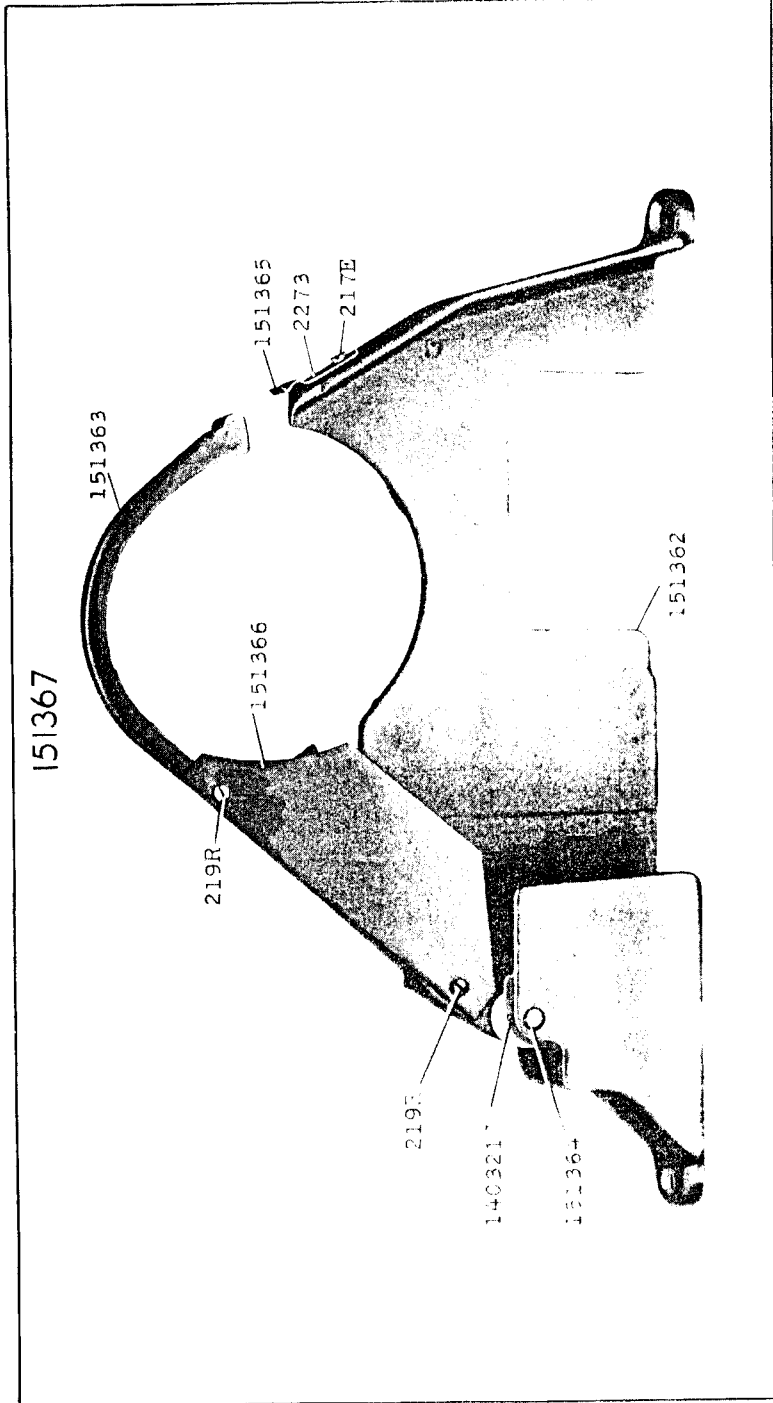

25092 1/6

