

SINGER
29K

SINGER INDUSTRIAL PRODUCTS CATALOG

SPECIAL EDITION

**PARTS FOR
SHOE and
BOOT REPAIR**

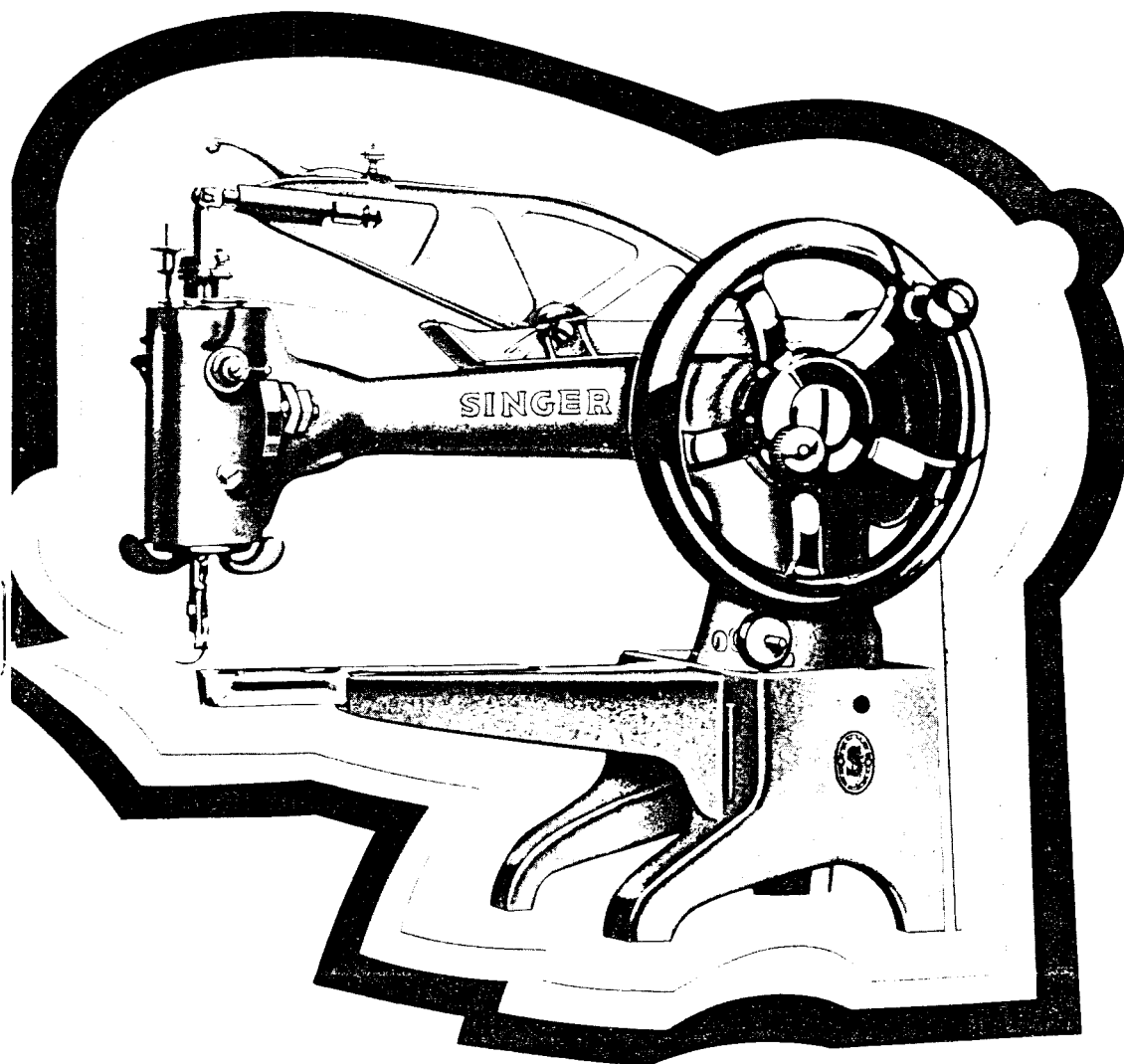

**THE SINGER COMPANY
PISCATAWAY, N.J.**

**Single Needle Lockstitch
(Type 301)
Cylinder Bed
Universal Upper Feed**

29K

Description of Class

Ideal for shoe and boot repairing and general stitching on tubular articles of leather, canvas, etc. Versatility of these machines is increased by use of a work table, furnished at extra charge, that enables the machine to be used for general work in the same manner as a flat bed machine. The Class 29K machine can be driven by either foot power or electric drive.

Features

The universal upper feed, controlled by a winged lever above the feeding foot, allows the operator to stitch in any direction without turning the work. The feeding foot rises 1/4" (6.4mm) during feed action. The manual lift of the feeding foot is adjustable up to 3/8" (9.5mm). Machine can be furnished with the handwheel located at front of machine, or fitted on pulley end (to be specified on order). Max. stitch length: 5 (5.1mm) per inch. Max. speed: 500 s.p.m.

Individual Industrial Unit

29K71
Motor — K9
Work Table — 83968
Stand (Motor) — 102319
Stand (Foot power) — 102304
Light — 996227-502 with 625103-01 Bracket

29K72—29K73
Motor — K9
Work Table (29K72) — 83740
Work Table (29K73) — 83741
Stand (Motor) — 102320
Stand (Foot power) — 102305
Light — 996227-502 with 625103-01 Bracket

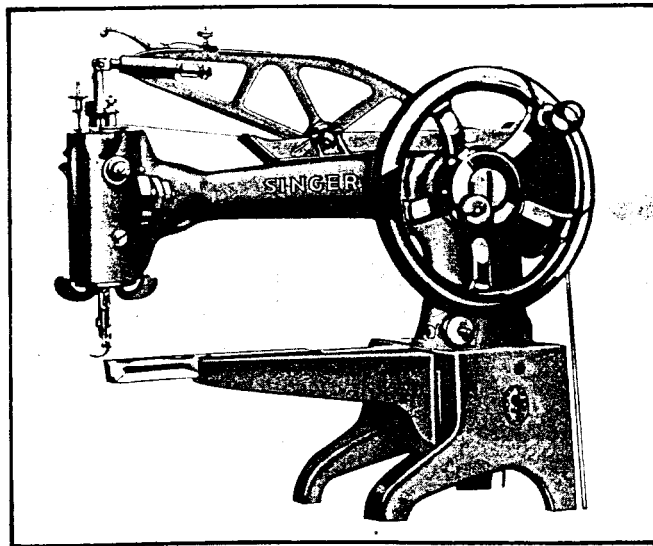

29K71 Machine

Small and narrow spaces such as toes of shoes, slippers, etc. Bed dimensions: width at end of cylinder 1" (25mm), depth 7/8" (22mm), space at right of needle 12-1/4" (31.1mm). Machine pulley (two speed): 2-7/8" (73.1mm) and 4-7/8" (123.8mm) dia. for round leather belt
Needle: Cat. 3750 (29 x 4)

29K72 Machine

Long tubular work such as high topped boots, golf bags, etc. Bed dimensions: width at end of cylinder bed 1-5/32" (29mm), depth 1-1/16" (27mm), space at right of needle 17-1/2" (445mm) Machine pulley (two speed): 3-1/4" (82.6mm) and 5-1/2" (139.7mm) dia. for round leather belt
Needle: Cat. 3750 (29 x 4)

29K73 Machine

Lengthy cylindrical articles. Bed dimensions: width at end of cylinder bed 1" (25mm), depth 7/8" (22mm), space at right of needle 17-1/2" (445mm) Machine pulley (two speed): 3-1/4" (82.6mm) and 5-1/2" (139.7mm) dia. for round leather belt
Needle: Cat. 3750 (29 x 4)

How to place your parts and needle orders for fast delivery service

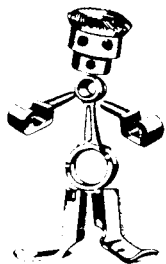

Call on Singer for prompt authentic replacements through Singer

For fast "same day" shipments, place your parts and needle orders directly with our Murfreesboro Distribution Center by Telephone, Mail, Teletype or Telex — whichever is most convenient.

Use convenient Air Mail Order Forms to speed handling of your next mail order for Singer replacement parts and needles. Postage-free order cards and envelopes are available on request.

To place an **emergency** order for parts or needles any time, day or night, use our new toll-free telephone service called "SPEED" (Singer Parts Emergency — Expedited Delivery). The special number is **(800) 251-8523**. Orders received during regular hours will be shipped immediately; those recorded at night will be shipped the following morning.

⁹ Tennessee customers call "collect": **(615) 893-6499** from 8:00 A.M. to 4:30 P.M. (CT).

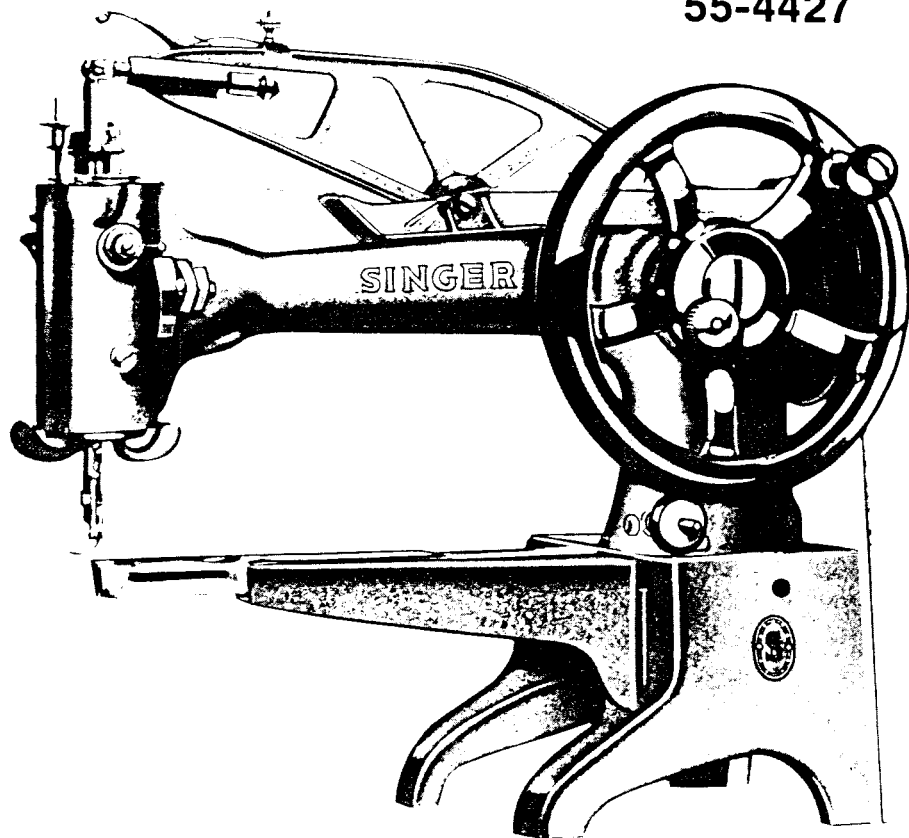

**The Singer Company
Parts Distribution Center
U.S. 41-N
Murfreesboro, Tennessee 37130**

**Call Customer Service Dept.
(615) 893-6493**

810-381-4382

55-4427

machine parts chart for SINGER 29K71

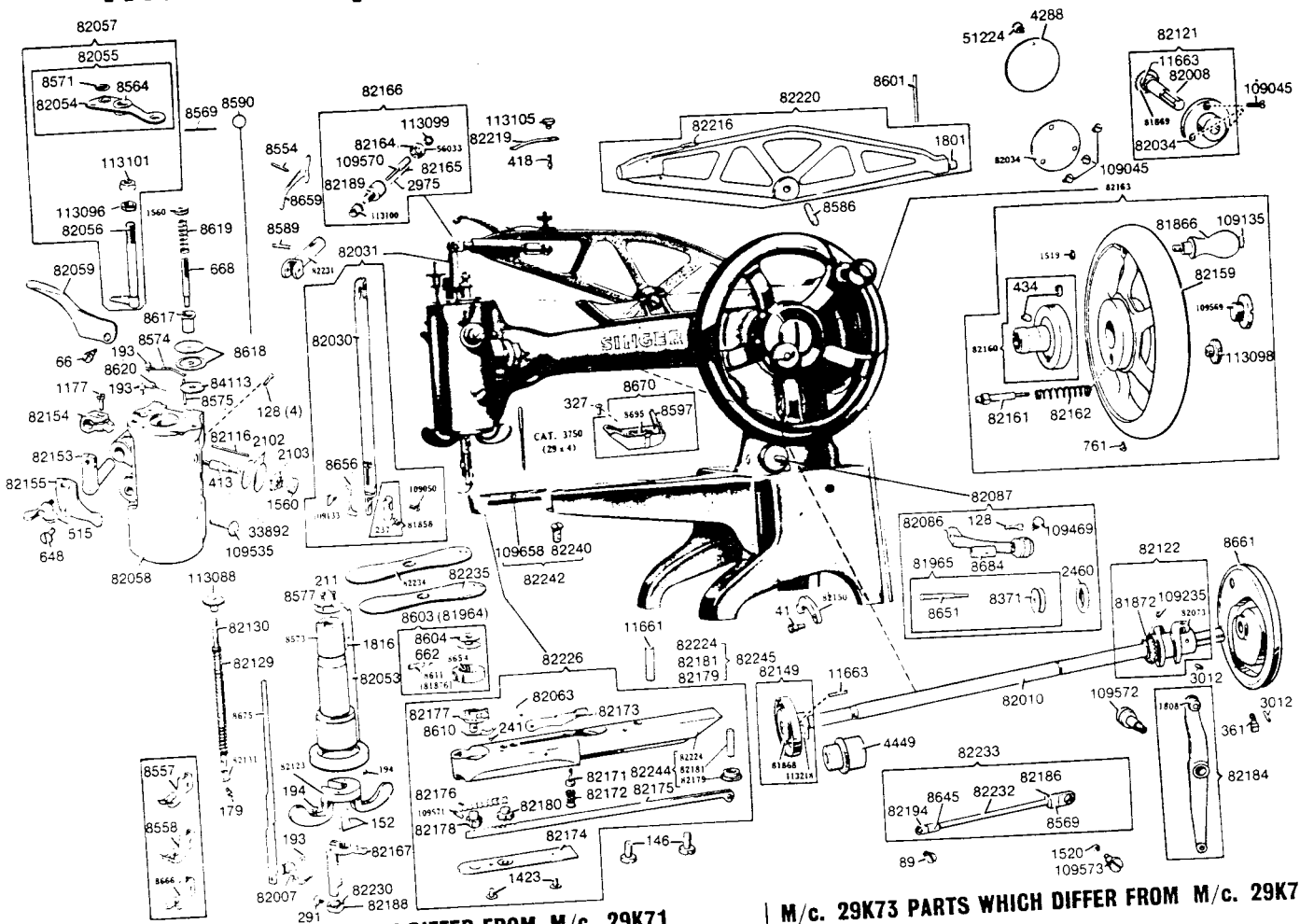

M/c. 29K72 PARTS WHICH DIFFER FROM M/c. 29K71

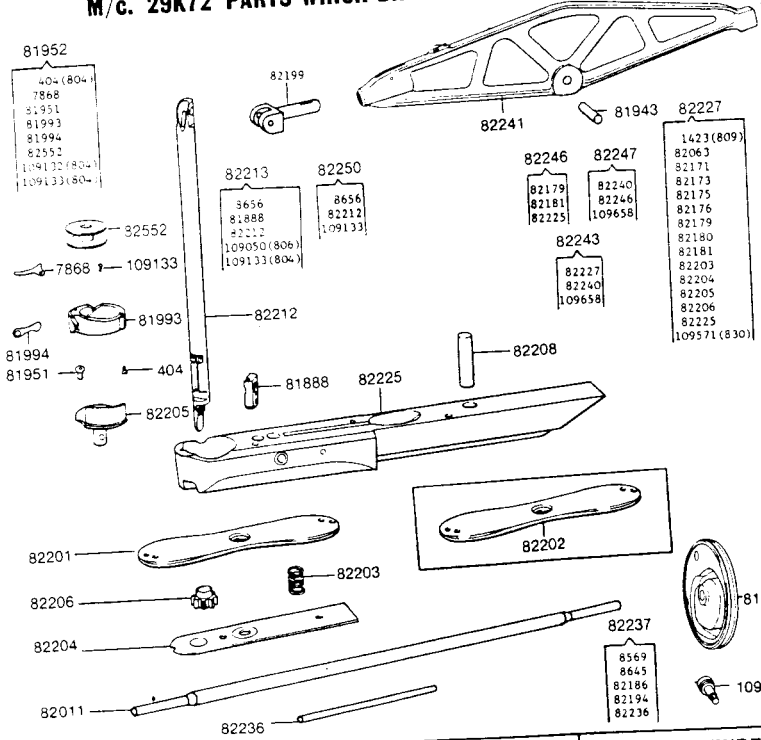

M/c. 29K73 PARTS WHICH DIFFER FROM M/c. 29K72

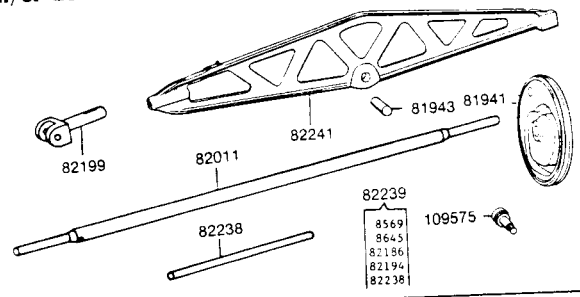

ACCESSORIES

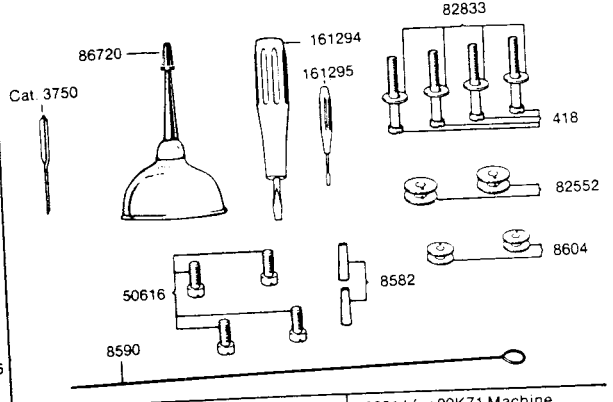

BOBBIN WINDER COMPLETE FOR M/c. 29K72

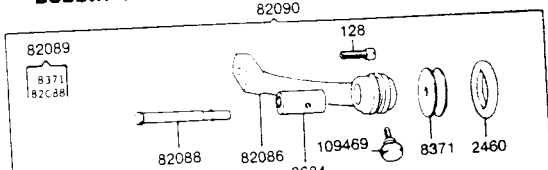

BOBBIN WINDER COMPLETE FOR M/c. 29K73

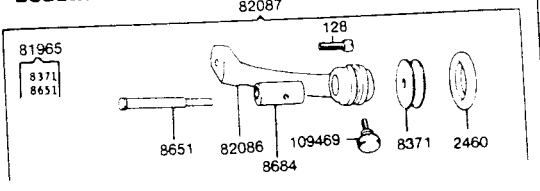

82214 for 29K71 Machine
82113 for 29K72 and 29K73 Machine

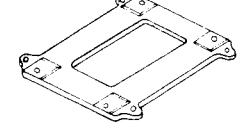

Part No.	Description	Part No.	Description
41	Vibrating Presser Foot Lifting Lever Screw	3012	Needle Bar Cam and Pulley Wheel Pin
66	Lifter Hinge Screw	3012	Shuttle Driving Cam Gear Pin
89	Shuttle Driving Lever	4288	Arm Side Cover (back)
	Connecting Rod Hinge Screw	4449	Shaft Bushing
128	Bobbin Winder Frame Screw	8371	Bobbin Winder Spindle Pulley
128	Head Binding Screw	8554	Check Lever Joint Pin
146	Shuttle Driving Gear Box Screw	8557	Feeding Foot (narrow fork fine)
152	Head Revolving Bush Handle Screw	8558	Feeding Foot (narrow fork coarse)
179	Vibrating Presser Spring Bar Collar Screw	8564	Foot Bar Revolving Joint
193	Feeding Foot Screw	8569	Foot Bar Revolving Joint Hinge Pin
193	Head Revolving Bush Friction Spring Screw	8569	Shuttle Driving Lever Connecting Roll End Pin (back)
193	Thread Eyelet Screw	8571	Foot Bar Revolving Joint Washer
194	Feed Motion Bell Crank Lever Joint Screw	8573	Head Revolving Bush
211	Head Revolving Bush Supporting Washer Screw	8574	Head Revolving Bush Friction Spring
237	Needle Bar Needle Clamping Screw	8575	Head Revolving Bush Friction Spring Pin
241	Shuttle Carrier Spring Screw	8577	Head Revolving Bush Supporting Washer
291	Stitch Regulator Thumb Screw	8586	Needle Bar Driving Lever Joint Pin
327	Oil Cup Screw	8589	Needle Bar Piston Joint Pin
361	Needle Bar Cam and Pulley Wheel Set Screw	8590	Needle Bar Threading Wire
413	Tension (side) Adjusting Stud	8597	Oil Cup Spring
416	Check Lever Tension Stud	8601	Spool Pin
434	Hand Wheel Stop Motion Flanged Bushing Binding Screw	8603	Shuttle complete
515	Vibrating Presser Lifting Lever Shaft	8604	Shuttle Bobbin
	Adjusting Lever Clamping Screw	8610	Shuttle Carrier Spring
648	Vibrating Presser Lifting Lever Shaft Adjusting Lever Hinge Screw	8611	Shuttle Tension Spring
662	Shuttle Tension Regulating Screw	8617	Tension (top) Cup (release)
668	Tension (top) Adjusting Stud	8618	Tension (top) Disc
761	Hand Wheel Stop Motion Plunger Stop Screw	8619	Tension (top) Spring
1177	Vibrating Presser Lifting Lever Shaft Lever Clamping Screw	8620	Thread Eyelet (head of arm)
1423	Pinion Cover Plate Screw	8645	Shuttle Driving Lever Connecting Rod End Pin (front)
1519	Hand Wheel Handle Spindle Nut	8651	Bobbin Winder Spindle
1520	Shuttle Driving Lever Eccentric Stud Nut	8654	Shuttle Body
1560	Tension (side) Adjusting Stud Thumb Nut	8656	Needle Bar Thread Tension Spring
1560	Tension (top) Adjusting Stud Thumb Nut	8659	Check Lever
1801	Needle Bar Driving Lever Cam Roller and Stud	8661	Needle Bar Cam and Pulley Wheel
1808	Shuttle Driving Cam Roller and Stud	8666	Feeding Foot (for waxed thread)
1816	Feed Motion Ring Slide Bar Roller and Stud	8670	Oil Cup
2102	Tension (side) Disc	8675	Foot Bar
2103	Tension (side) Spring	8684	Bobbin Winder Eccentric Oil Cup Oil Pad (cloth)
2460	Bobbin Winder Spindle Pulley Rubber Ring	8695	Shuttle Driving Gear Box Position Pin
2975	Check Lever Indicator Index Head Locating Plunger Spring	11661	Hand Wheel Shaft Gear Pin
		11663	Feed Motion Cam Wheel Pin
		33892	Tension (side) Adjusting Stud complete
		51224	Arm Side Cover (back) Thumb Screw
		56033	Check Lever Indicator Index Head Stop Pin
		81858	Needle Bar Clamp
		81866	Hand Wheel Handle (wood)
		81868	Vibrating Presser Roller Pin
		81869	Hand Wheel Shaft Gear
		81872	Shuttle Driving Cam Gear
		81876	Shuttle Tension Spring (heavy)

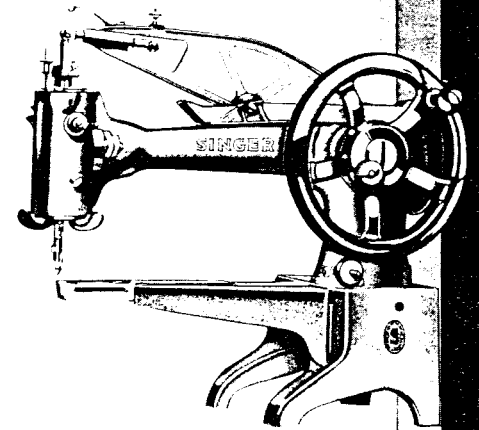

Part No.	Description
81964	Shuttle complete (for heavy work)
81965	Bobbin Winder Spindle complete
82007	Feeding Foot
82008	Hand Wheel Shaft
82010	Shaft
82030	Needle Bar
82031	Needle Bar complete
82034	Arm Side Cover (front) for use when machine is fitted with Hand Wheel on end of Shaft
82052	Hand Wheel Hub
82053	Feed Motion Ring Slide Bar
82054	Foot Bar Revolving Joint Bearing
82055	Foot Bar Revolving Joint Bearing complete
82056	Foot Bar Revolving Joint Slide Rod
82057	Foot Bar Revolving Joint complete
82058	Head of Machine
82059	Lifter
82063	Needle Plate Releasing Lever Hinge Pin
82073	Shuttle Driving Cam
82086	Bobbin Winder Frame
82087	Bobbin Winder complete
82116	Tension (side) Thread Guide Pin
82121	Hand Wheel Hub complete
82122	Shuttle Driving Cam and Gear complete
82123	Hand Revolving Bush Handle
82129	Vibrating Presser Spring (heavy)
82130	Vibrating Presser Spring Bar
82131	Vibrating Presser Spring Bar Collar
82149	Feed Motion Cam Wheel
82150	Vibrating Presser Lifting Lever (for medium work)
82153	Vibrating Presser Lifting Lever Shaft

**SUPPLEMENTARY PARTS LIST FOR
MACHINE 29K72**

PARTS REMOVED

Part No.	Description
81858	Needle Bar Clamp with 237(806)
81876	Shuttle Tension Spring
82010	Shaft
82030	Needle Bar
82031	Needle Bar complete. Nos. 81858, 82249 and 109050(806)
82172	Needle Plate Locating Plunger Spring
82174	Pinion Cover Plate
82177	Shuttle Carrier with 241(804) and 8610
82178	Shuttle Carrier Driving Pinion
82220	Needle Bar Driving Lever with 1801 and 82216
82224	Shuttle Driving Gear Box
82226	Shuttle Driving Gear Box complete. Nos. 82063, 82171 to 82181, 82224, 109571(830) and two 1423(809)
82231	Needle Bar Piston Joint
82232	Shuttle Driving Lever Connection Rod
82233	Shuttle Driving Lever Connection Rod complete. Nos. 8569, 8645, 82186, 82194 and 82232
82234	Needle Plate (medium and coarse needle holes)
82235	Needle Plate (fine and medium needle holes)
82242	Shuttle Driving Gear Box 82226 with 109658 and 82240
82244	Shuttle Driving Gear Box 82224 with 82179 and 82181
82245	Shuttle Driving Gear Box 82244 with 109658 and 82240
82249	Needle Bar 82030 with 8656 and two 109133(804)
109572(803)	Shuttle Driving Lever Bearing Screw

**SUPPLEMENTARY PARTS LIST FOR
MACHINE 29K73**

(Same as complete list for 29K71 with the following exceptions)

PARTS ADDED

81941	Needle Bar Cam and Pulley Wheel with 361(803)
81943	Needle Bar Driving Lever Joint Pin
82011	Shaft
82199	Needle Bar Piston Joint
82238	Shuttle Driving Lever Connection Rod
82239	Shuttle Driving Lever Connection Rod complete. Nos. 8569, 8645, 82186, 82194 and 82238
82241	Needle Bar Driving Lever 1801 with 82216
109575	Shuttle Driving Lever Bearing Screw

PARTS REMOVED

Part No.	Description
8586	Needle Bar Driving Lever Joint Pin
8661	Needle Bar Cam and Pulley Wheel with 361(803)
82010	Shaft
82220	Needle Bar Driving Lever with 1801 and 82216
82231	Needle Bar Piston Joint
82232	Shuttle Driving Lever Connection Rod
82233	Shuttle Driving Lever Connection Rod complete. Nos. 8569, 8645, 82186, 82194 and 82232
109572	Shuttle Driving Lever Bearing Screw

ACCESSORIES





128(804)	Bobbin Winder Frame Screw
418(805)	Machine Screw (for fastening machine to Power Table)
2460	Bobbin Winder Spindle Pulley Rubber Ring
8371	Bobbin Winder Spindle Pulley
8582	Lower Arm and Bed Steady Pin
8590	Needle Bar Threading Wire
8604	Shuttle Bobbin for 8603 and 81964
8651	Bobbin Winder Spindle for 81965
8684	Bobbin Winder Eccentric
50616	Machine Screw (for fastening base to machine)
81965	Bobbin Winder Spindle 8651 with 8371 for 82087
82086	Bobbin Winder Frame
82087	Bobbin Winder complete. Nos. 128(804), 2460, 8684, 81965, 82086 and 109469 (818) for 29K71 and 29K73 Machines
82088	Bobbin Winder Spindle for 82089
82089	Bobbin Winder Spindle 82088 with 8371 for 82090
82090	Bobbin Winder Spindle complete. Nos. 128(804), 2460, 8684, 82086, 82089 and 109469(818) for 29K72 Machine
82113	Machine Base for 29K72 and 29K73 Machines
82214	Machine Base for 29K71 Machine
82552	Shuttle Bobbin for 81952
82833	Machine Screw Washer







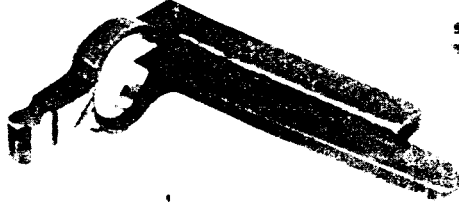
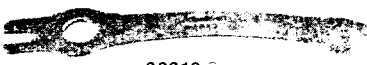
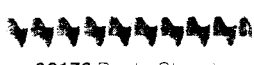
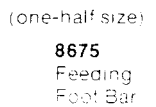

Part No.	Description
86720	Oiler
109469(818)	Bobbin Winder Eccentric Thumb Screw
161294	Screw Driver (large)
161295	Screw Driver (small)
Cat.3750	Needles (6)

Parts for 29K Machines

Popular Screws

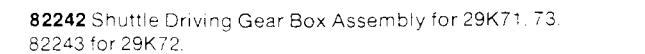
Screw No.	Description
109133	Bobbin Retaining Spring Screw
193	Feeding Foot Screw
237	Needle Clamping Screw
109050	Needle Clamp Screw
109658	Needle Plate Hinge Pin Screw
109571	Pinion Screw
404	Shuttle Thread Pull-Off Screw
291	Stitch Regulator Screw
109132	Tension Regulating Screw
109133	Thread Tension Spring Screw

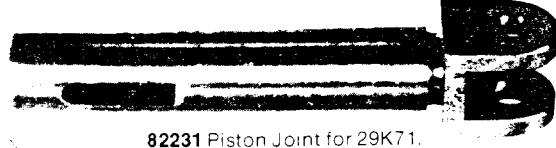
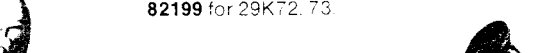
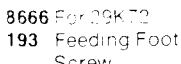
				
82178 Driving Pinion for 29K71, 73 82206 for 29K72	82180 Following Pinion	8604 Bobbin for 29K71, 73 82552 For 29K72	8606 Shuttle for 29K71, 73 81952 for 29K72	82177 Shuttle Carrier for 29K71, 73 82205 for 29K72

			
(one-half size)		82219 Spring	82176 Rack (Short)
82031 Needle Bar Assembly for 29K71, 73 82213 for 29K72			
Component Parts	8675 Feeding Foot Bar	(one-half size)	82175 Rack (long)
109050 Clamp Screw			
82030 Needle Bar for 29K71, 73	82234 Needle Plate (medium and coarse needle hole) for 29K71, 73 82202 for 29K72		82242 Shuttle Driving Gear Box Assembly for 29K71, 73 82243 for 29K72
82212 Needle Bar for 29K72			
81858 Needle Bar Clamp for 29K71, 73	82007 Feeding Foot for 29K71, 73		82231 Piston Joint for 29K71 82199 for 29K72, 73
81888 Needle Bar Clamp for 29K72			2460 Bobbin Winder Ring
237 Needle Clamping Screw	8666 For 29K72 193 Feeding Foot Screw		82240 Needle Plate Hinge Pin
8656 Thread Tension Spring			
109133 Thread Tension Spring Screw			

Additional Parts

82087	Bobbin Winder for 29K71, 73.	82122	Shuttle Driving Cam and Gear.
82090	Bobbin Winder for 29K72.	82233	Shuttle Driving Lever Connecting Rod for 29K71.
1801	Cam Roller and Stud.	82237	Shuttle Driving Lever Connecting Rod for 29K72.
8659	Check Lever.	82239	Shuttle Driving Lever Connecting Rod for 29K73.
8554	Check Lever Joint Pin.	8610	Shuttle Spring for 29K71, 73.
82230	Gib.	241	Shuttle Spring Screw for 29K71, 73.
82121	Hand Wheel Hub.	8611	Shuttle Tension Spring for 29K71, 73.
82220	Needle Bar Driving Lever for 29K71.	81994	Shuttle Tension Spring for 29K72.
82241	Needle Bar Driving Lever for 29K72, 73.	662	Shuttle Tension Regulating Screw for 29K71, 73.
8586	Needle Bar Driving Lever Joint Pin for 29K71.	109132	Shuttle Tension Regulating Screw for 29K72.
81943	Needle Bar Driving Lever Joint Pin for 29K72, 73.	82053	Slide Bar.
3012	Pin.	82188	Stitch Regulator.
82179	Pinion Bushing.	291	Stitch Regulator Thumb Screw.
8589	Piston Joint Pin.	2102	Tension Disc.
82123	Revolving Bush Handle.	2103	Tension Spring for 29K71, 73.
		80548	Tension Spring for 29K72.

PARTS ILLUSTRATIONS FULL SIZE (EXCEPT AS NOTED)

USE SINGER* DIE-PRESSED CHROME FINISH NEEDLES