

**SINGER**  
**451K11,K111**

Form K6385

ILLUSTRATED  
LIST OF PARTS

FOR

Nos. 451K11 and 451K111  
Machines

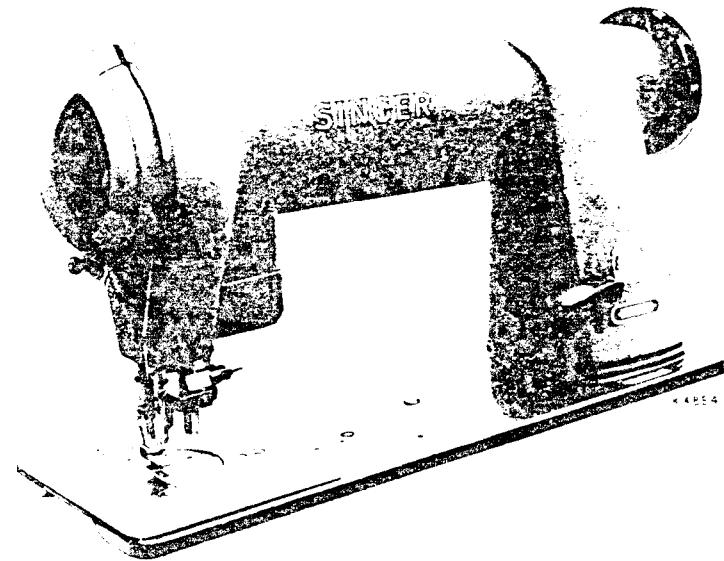

No. 451K111 Machine

\*\*A Trademark of THE SINGER MANUFACTURING CO.

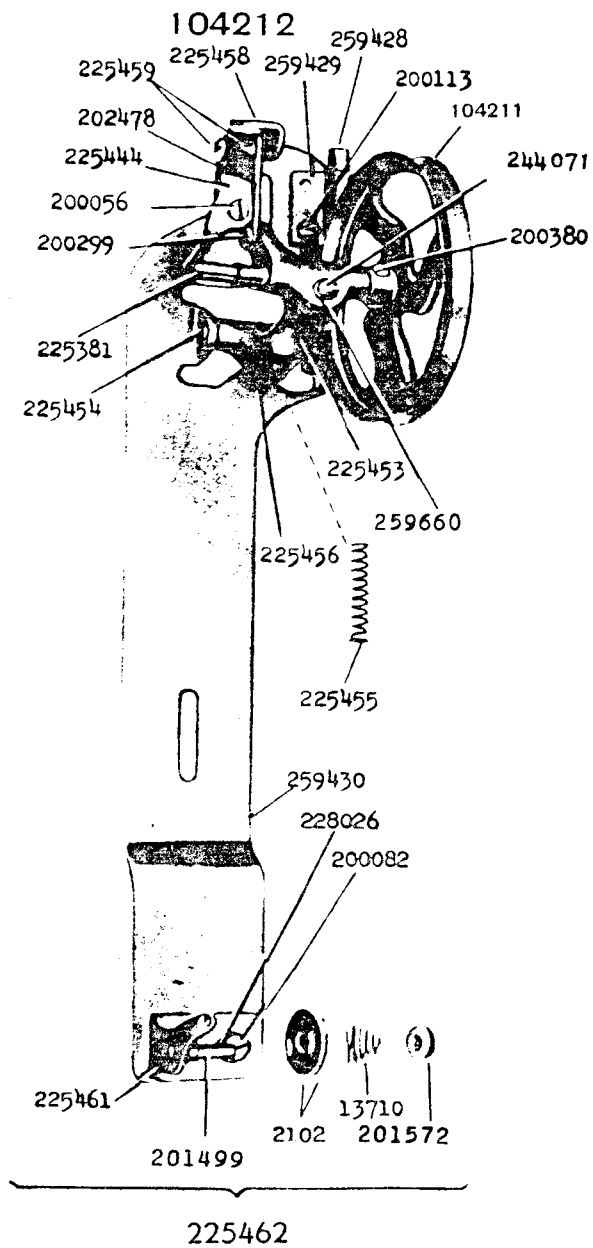

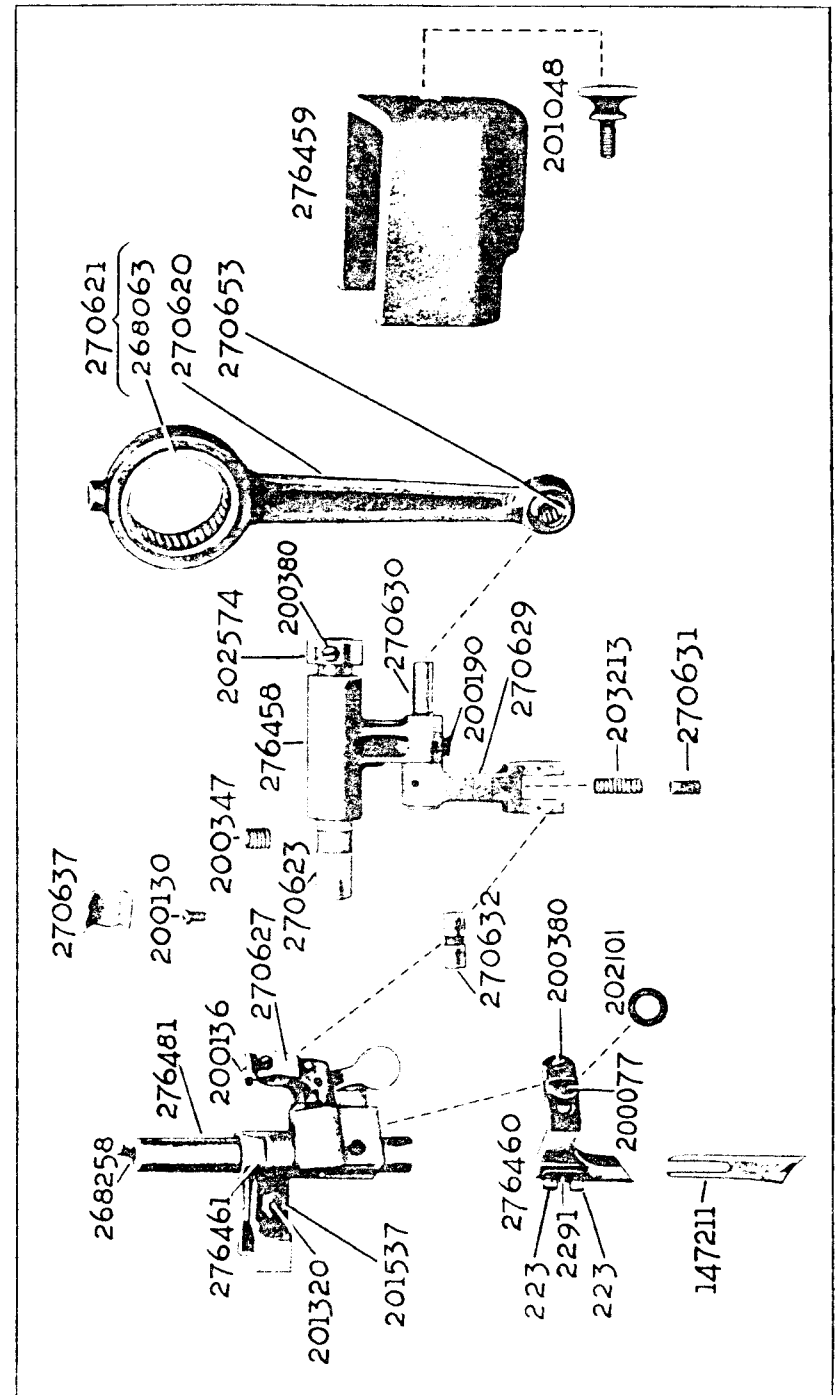
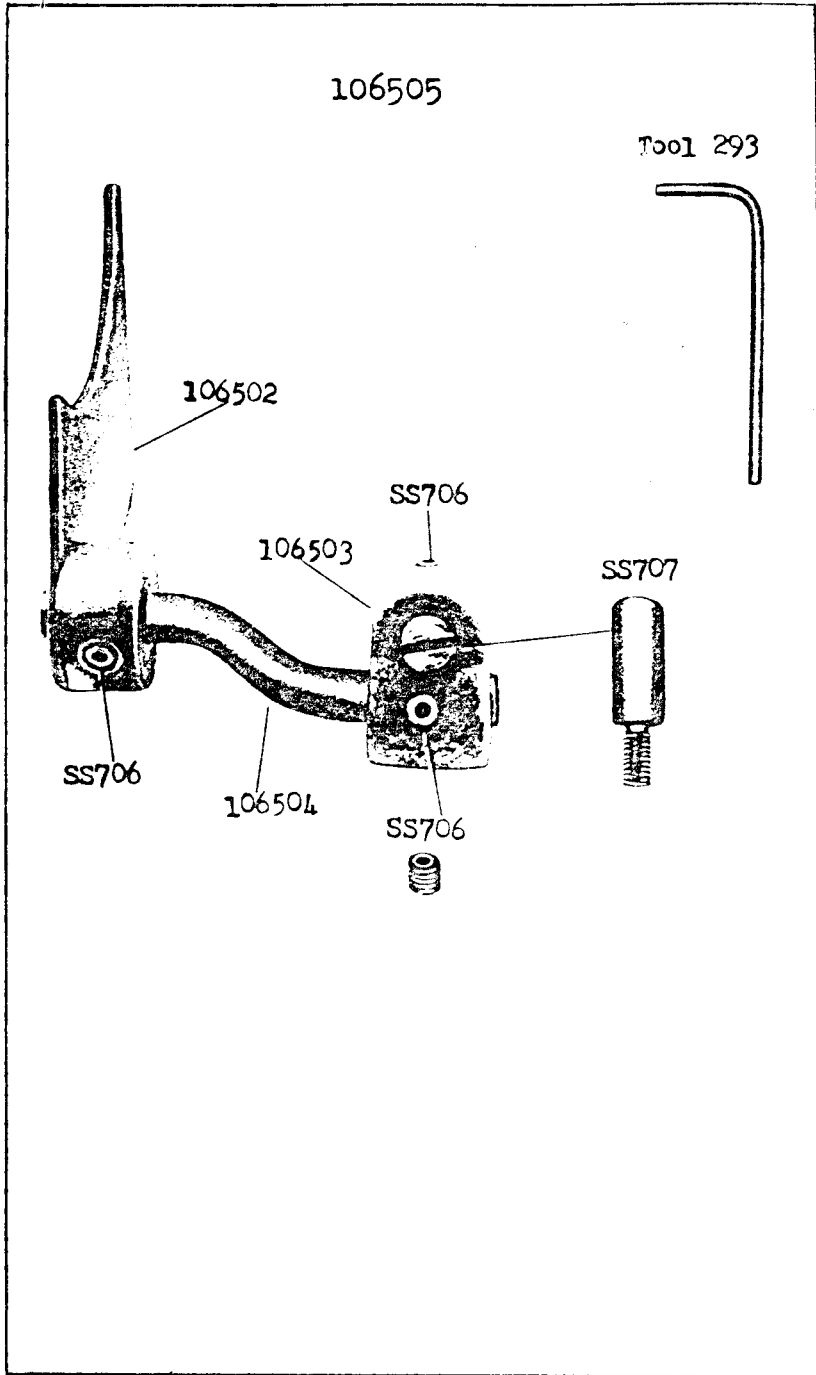

276454

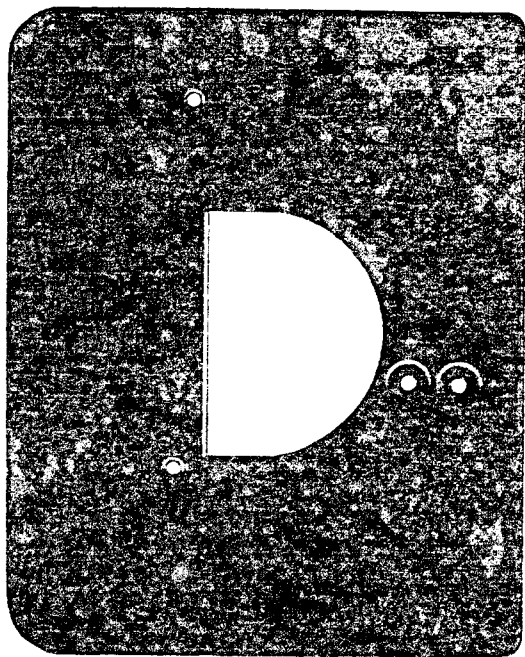

1423  
U  
1423  
U

272139

270873

52237

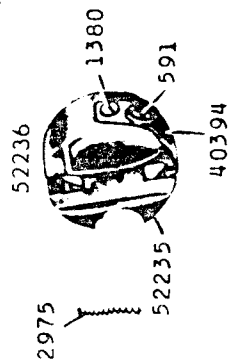

592

40393

40392



272138

272137

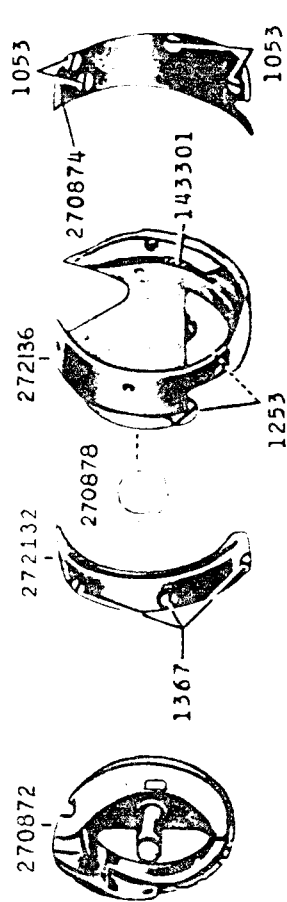

1253

270879

272131

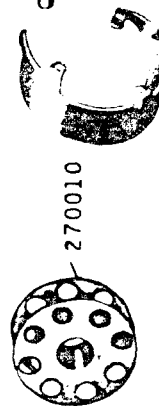

270010

200077



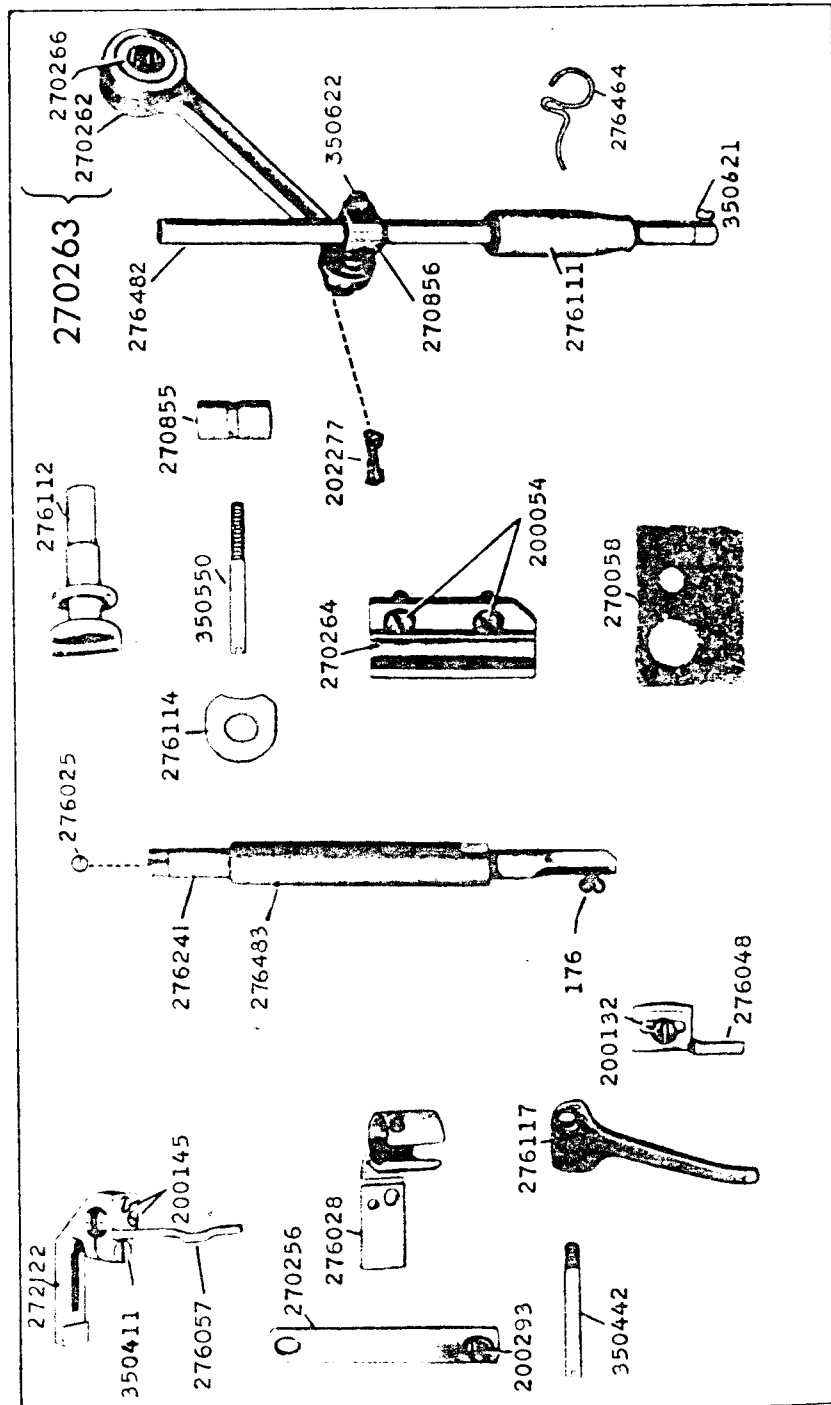
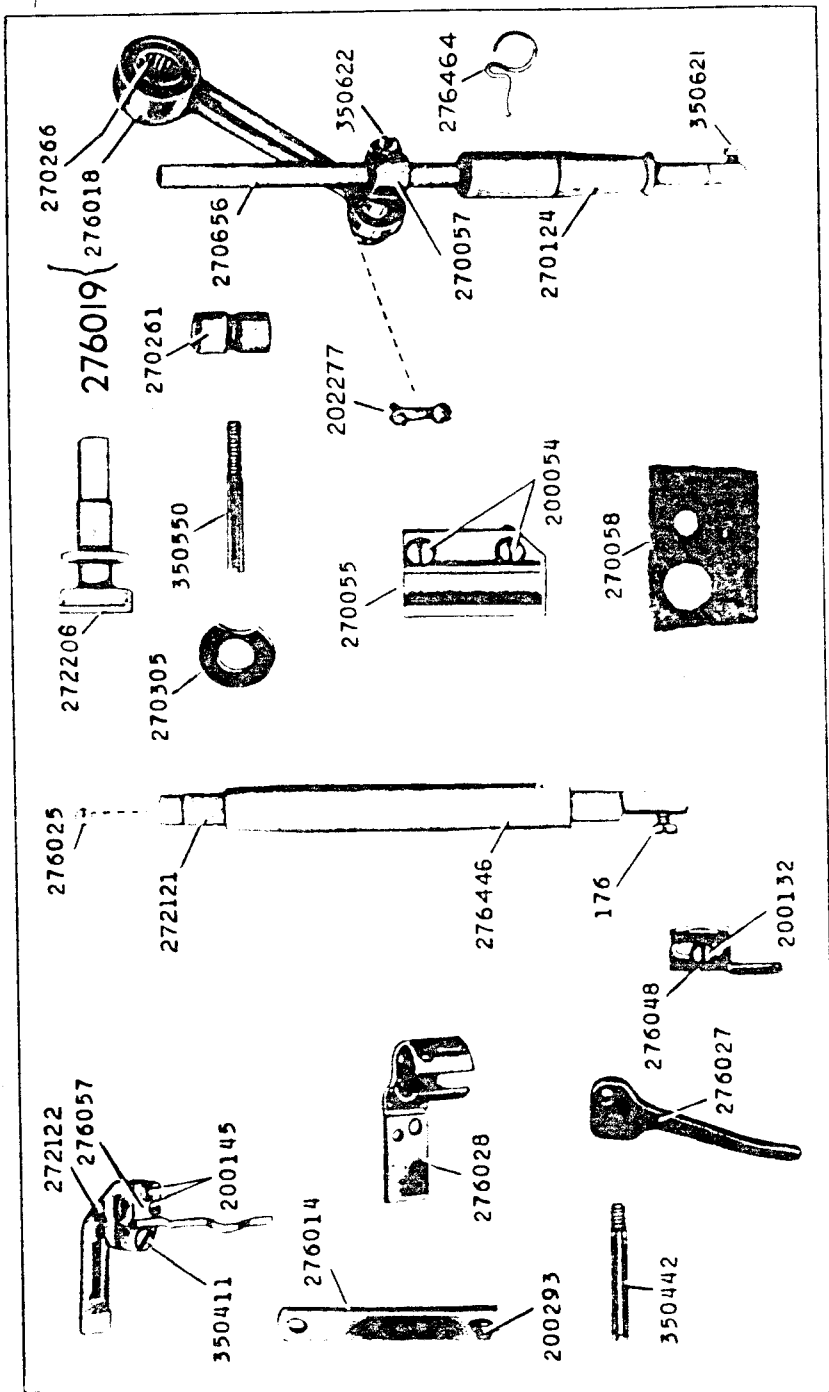

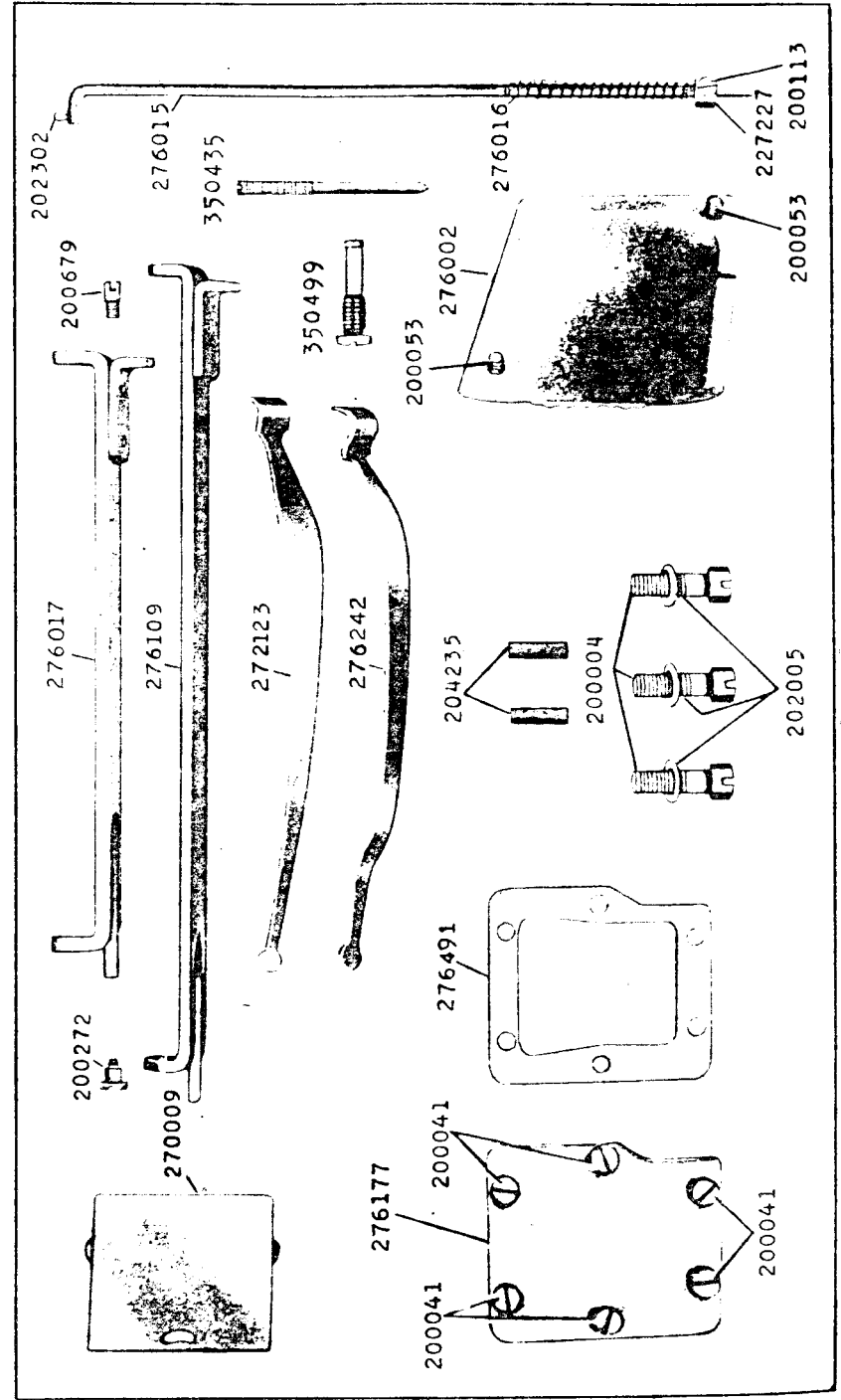
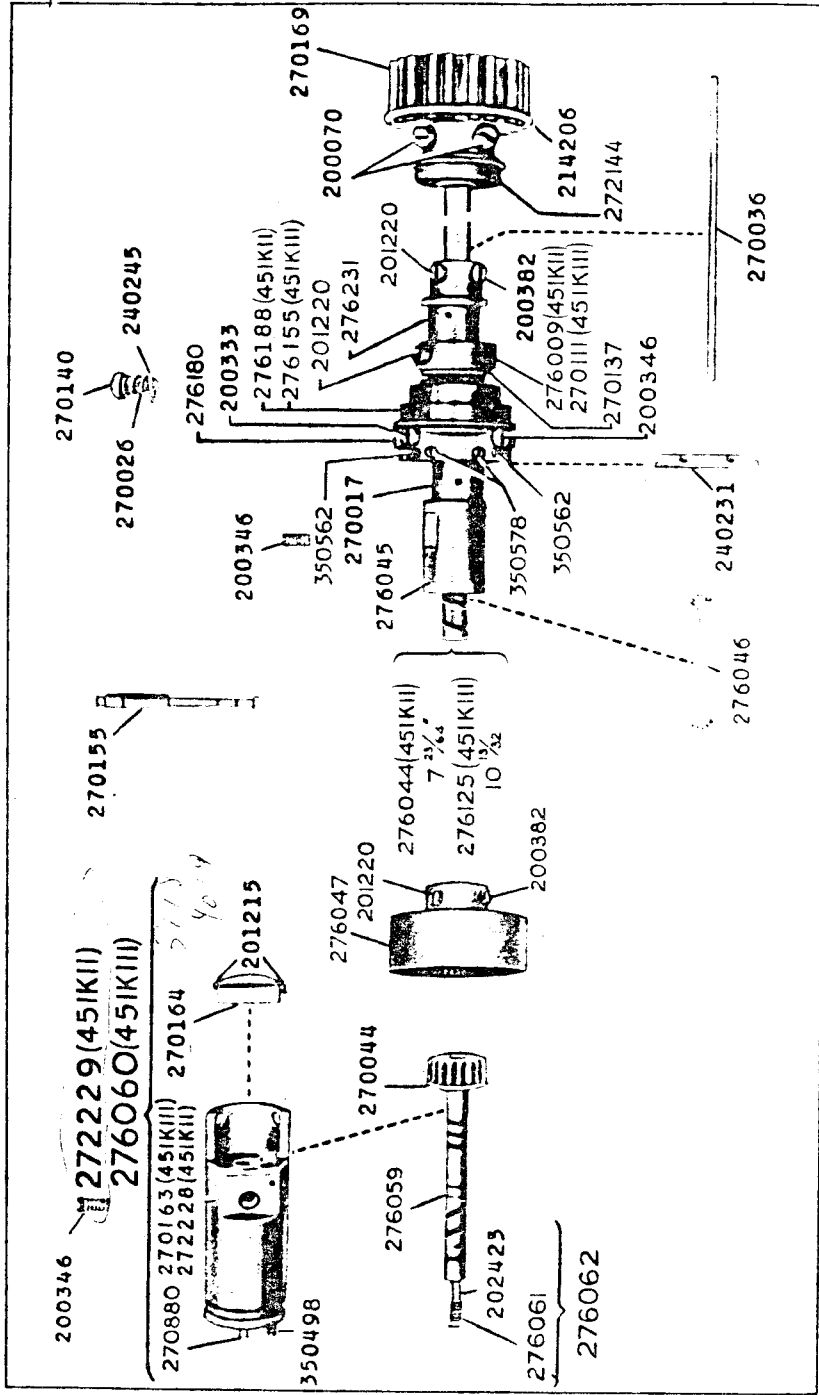



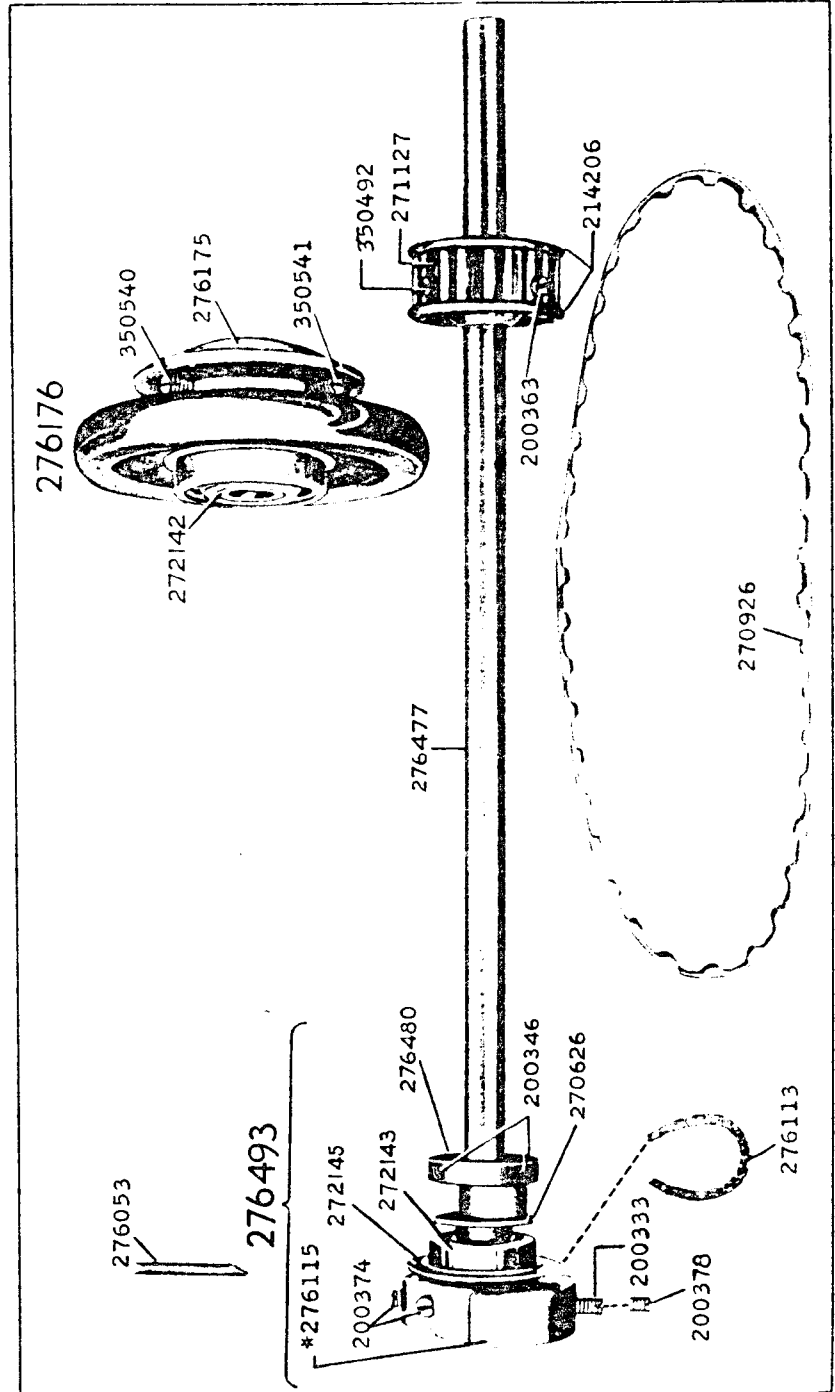
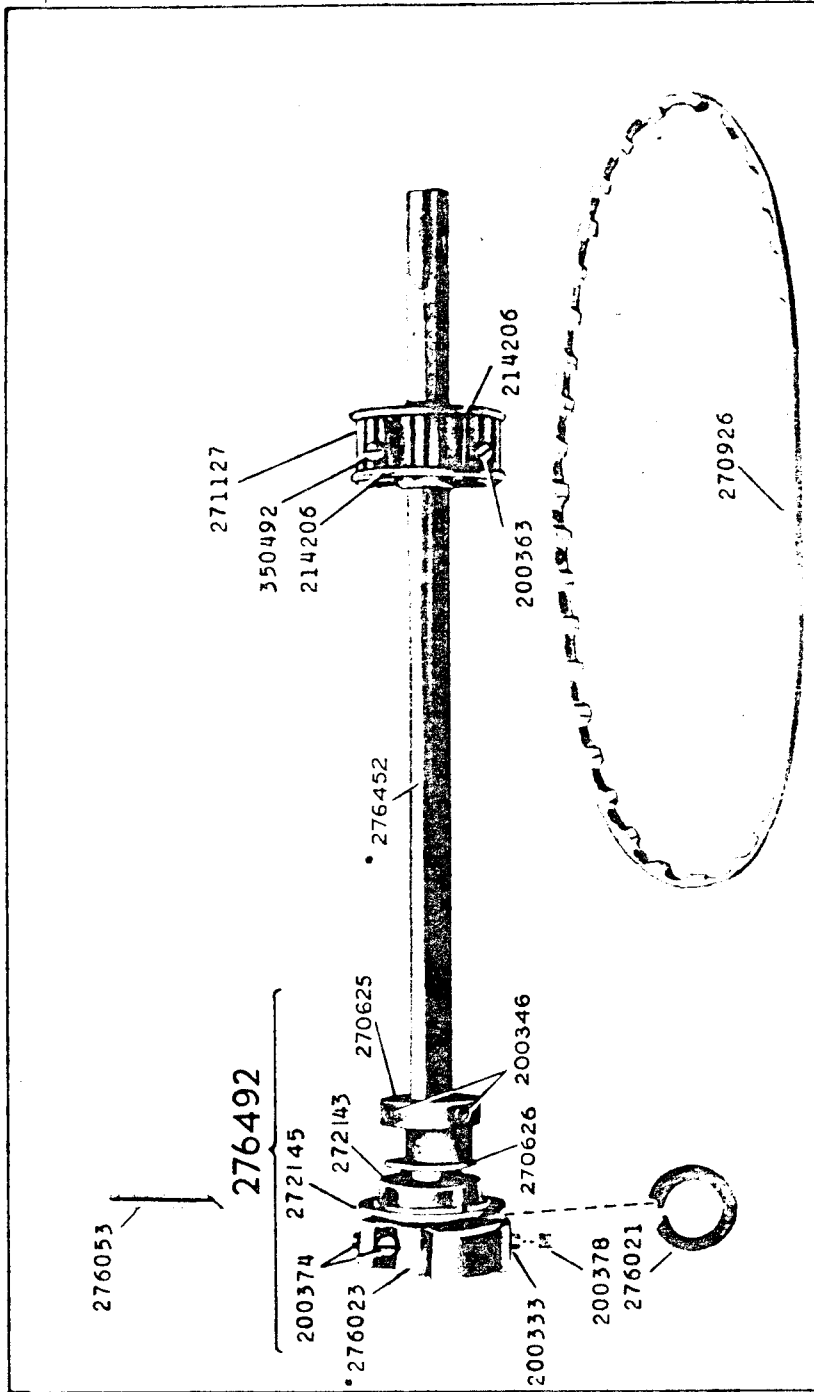

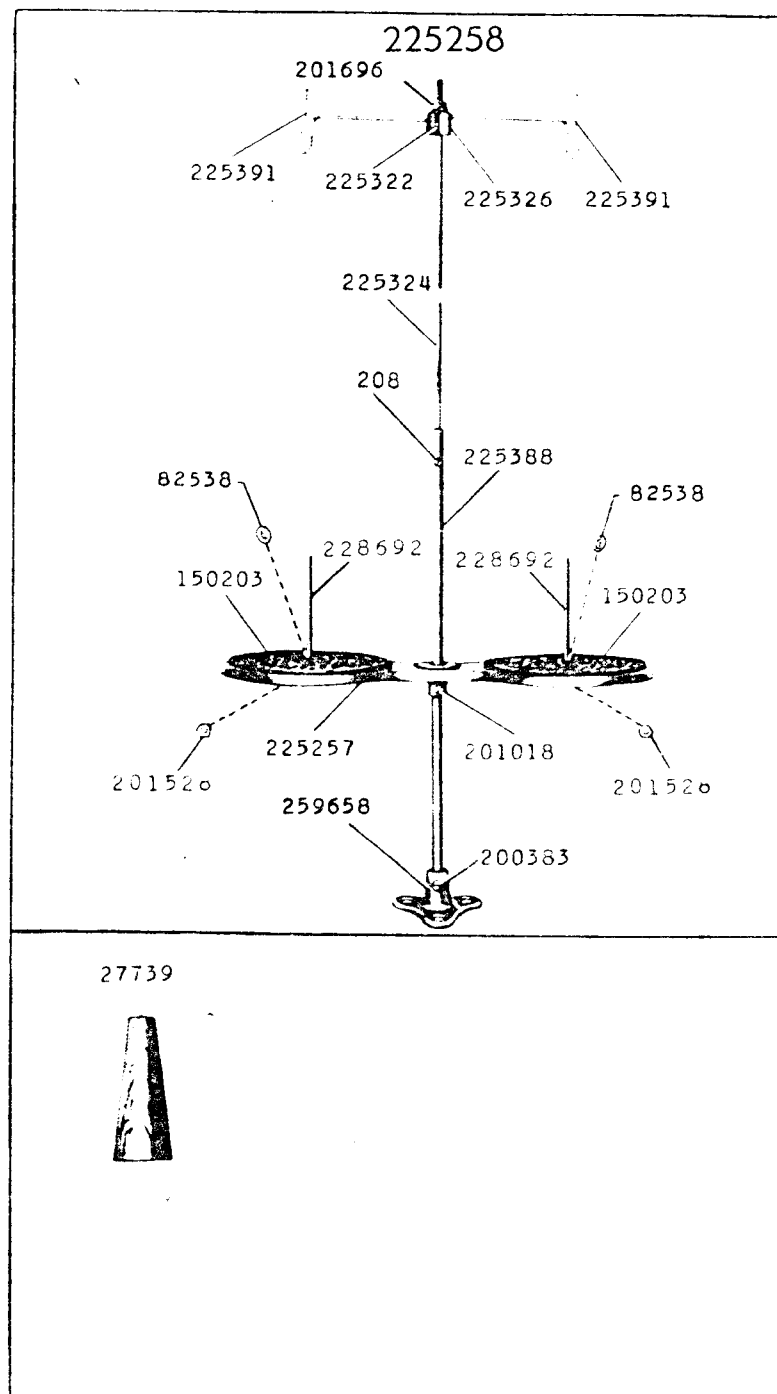
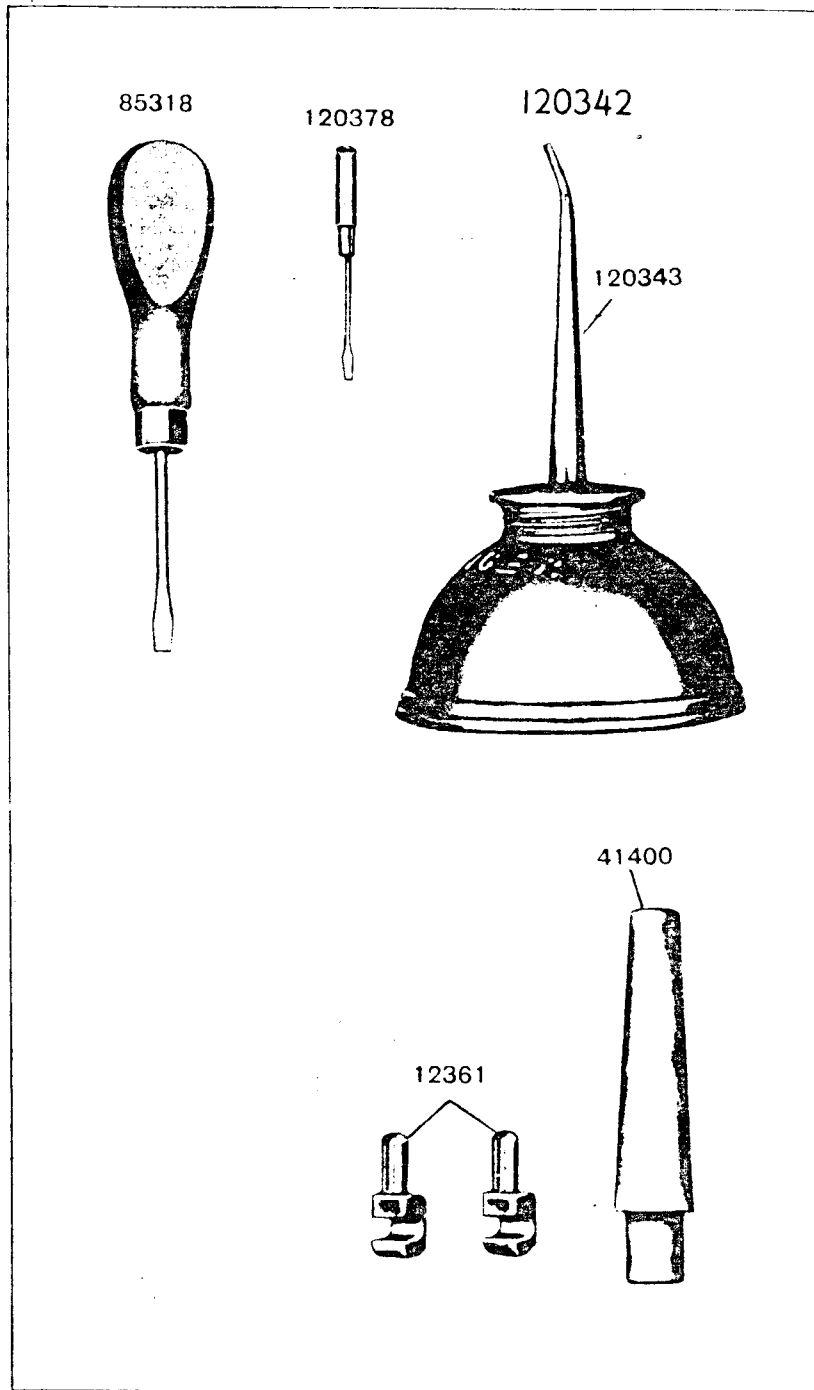

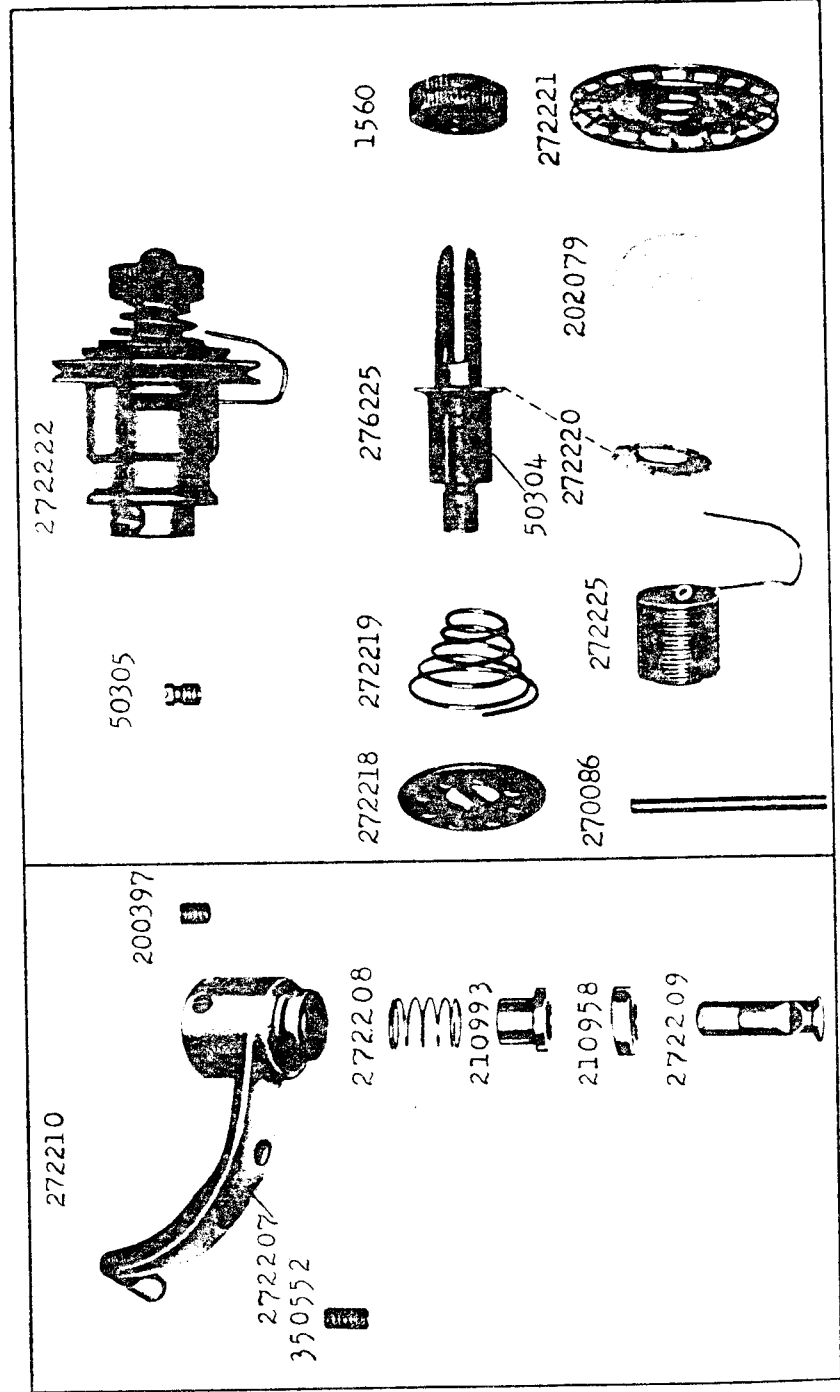
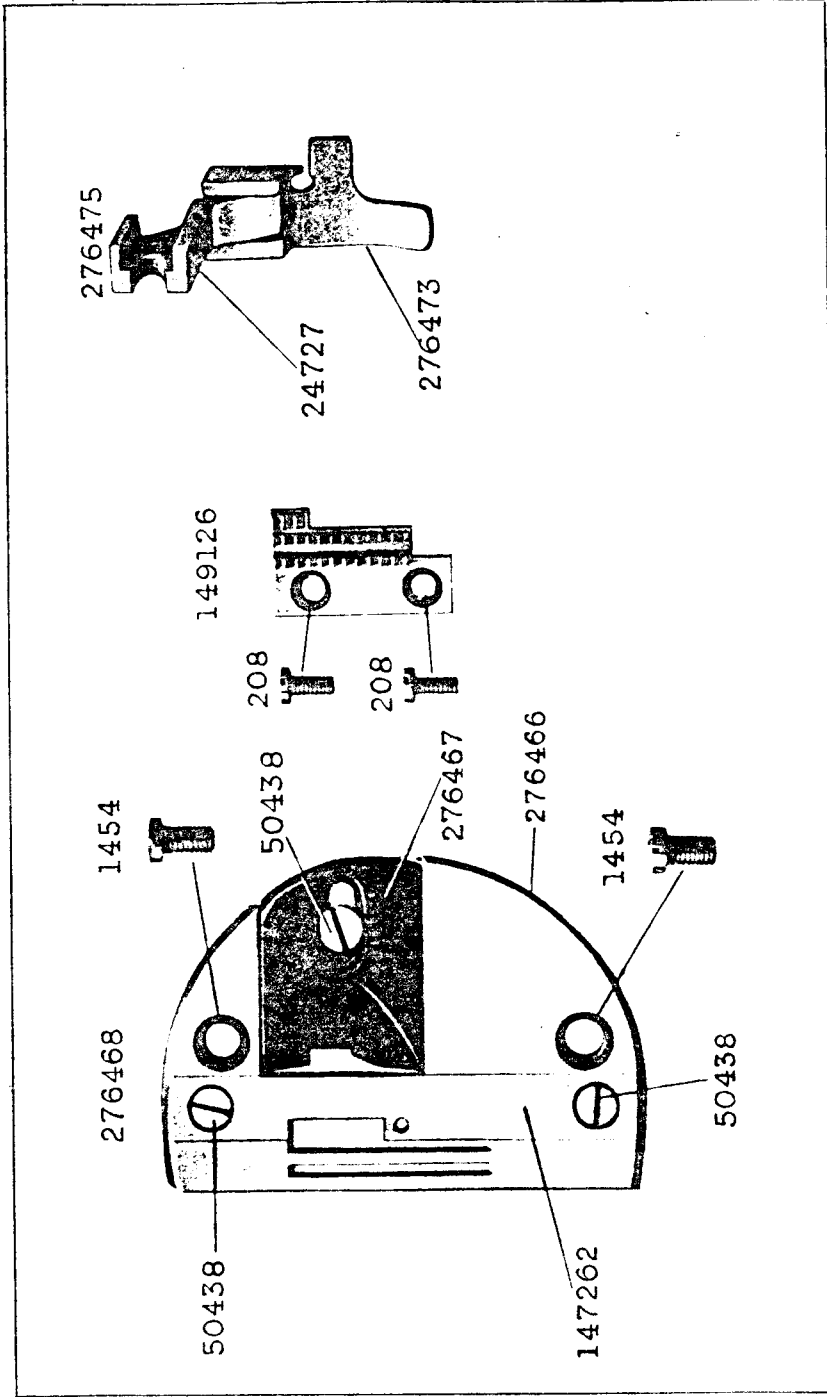

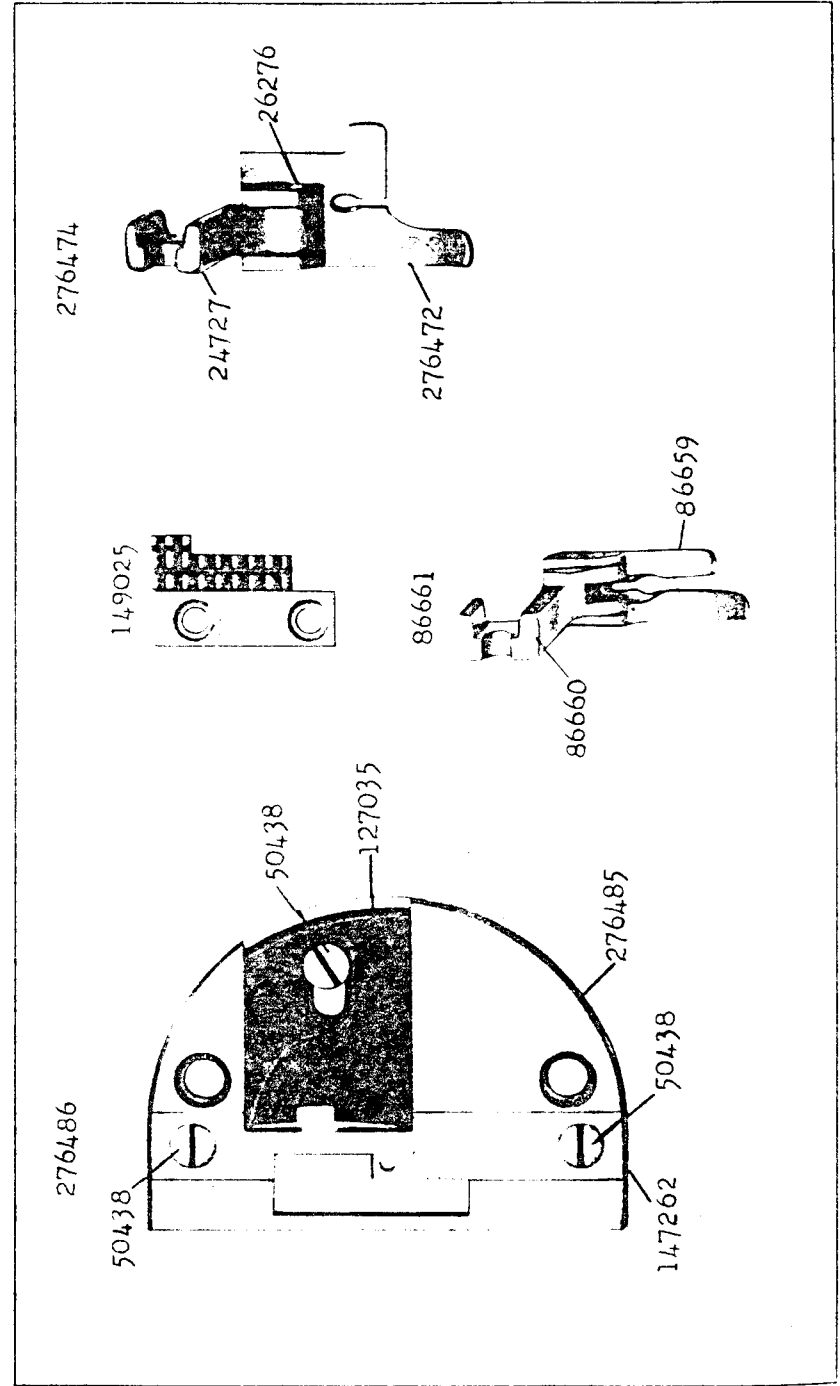
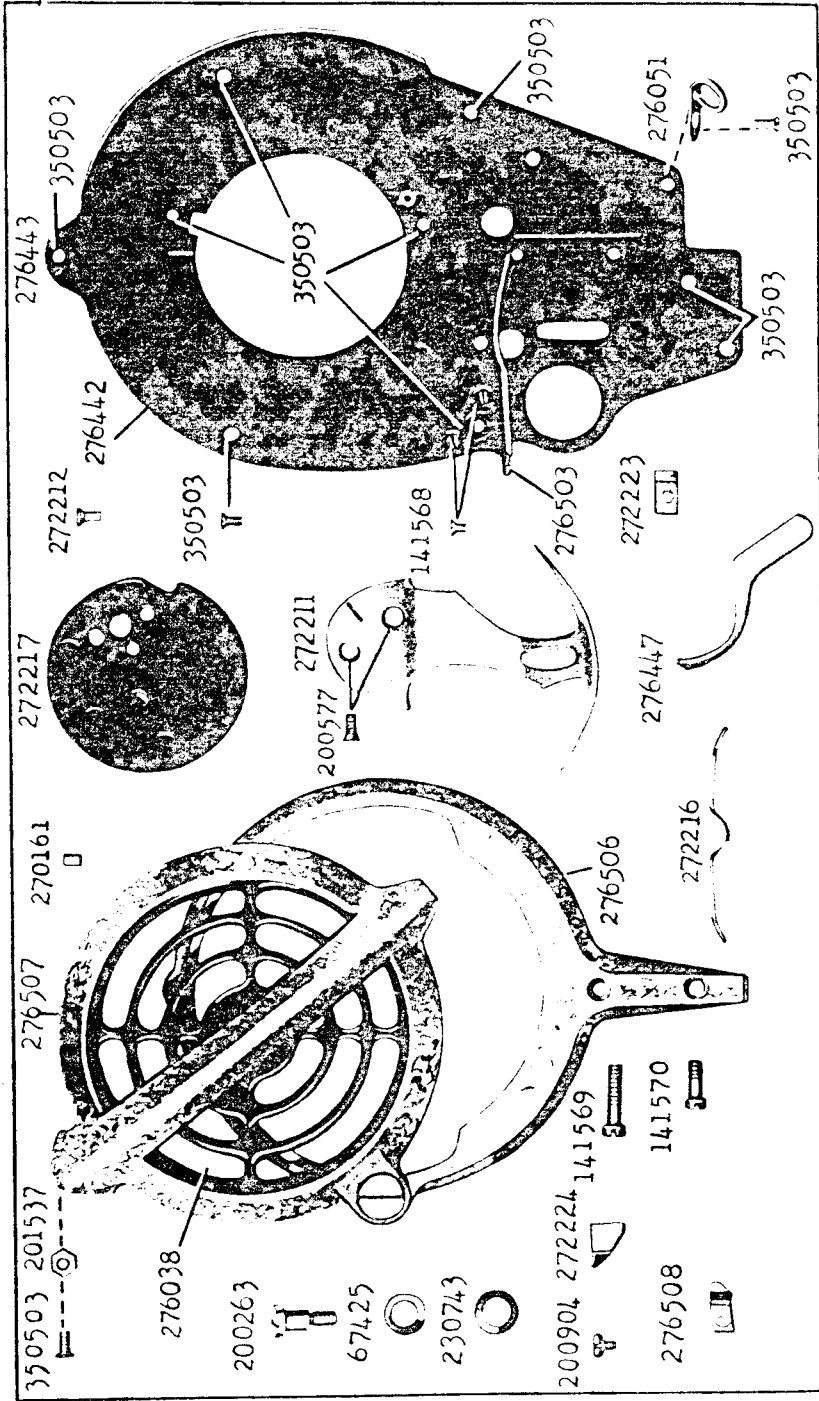

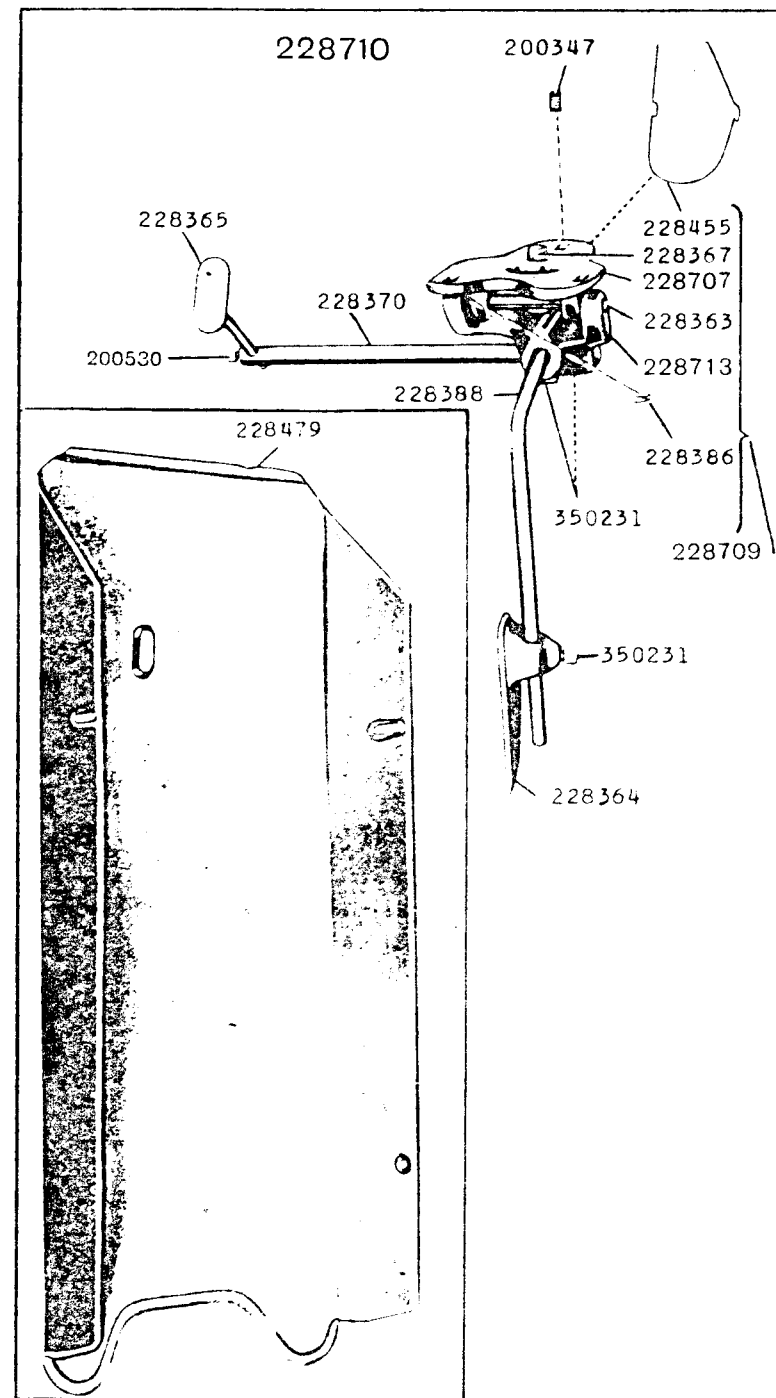
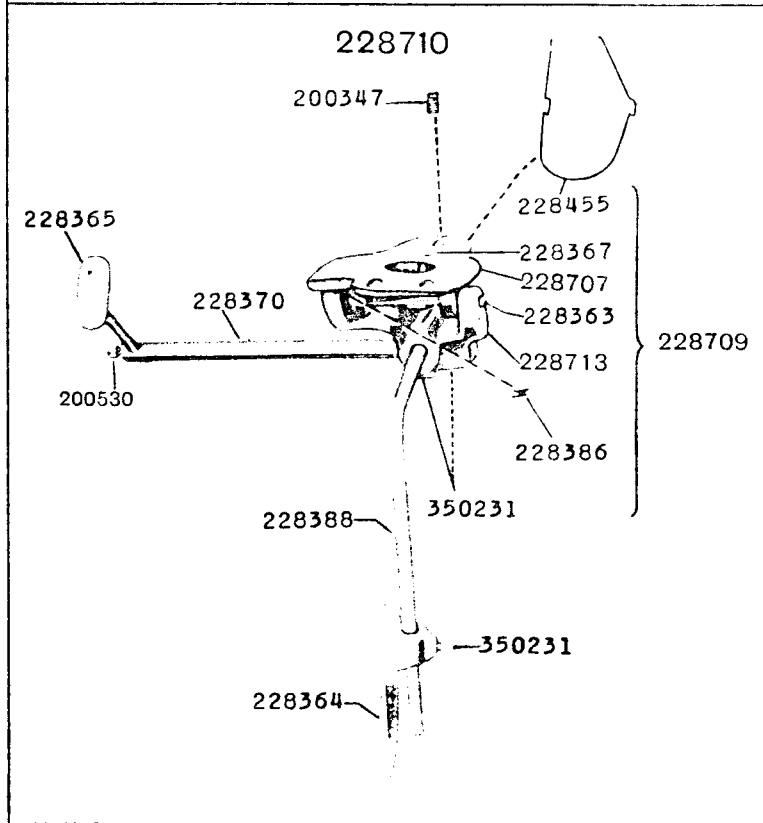
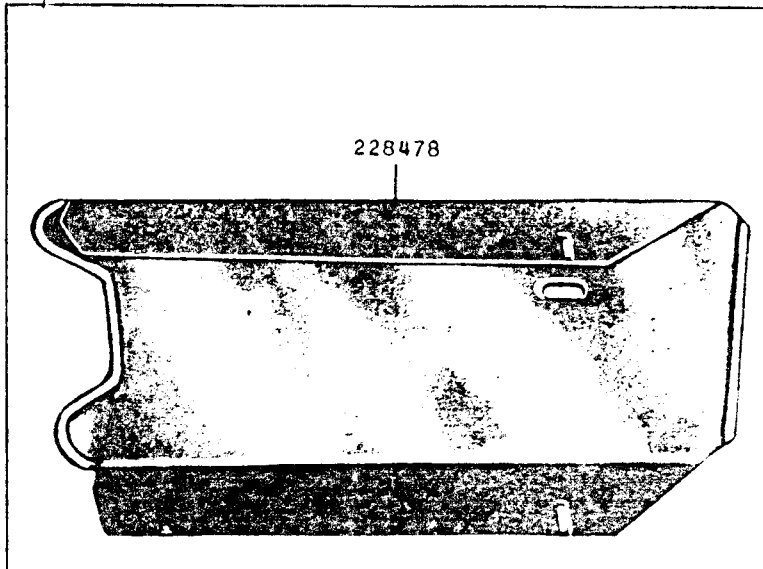

LIST OF PARTS

FOR

Nos. 451K11 and 451K111

Machines

## INSTRUCTIONS FOR OILING

---

BEFORE STARTING THE MACHINE, fill reservoir in base to "high" mark. Inspect often enough to keep oil level from going below "low" mark in base.

To ensure easy running and prevent unnecessary wear of the parts which are in movable contact, the machine requires oiling and when in continuous use, "TYPE A" or "TYPE C" OIL, sold only by Singer Sewing Machine Company, should be applied at the beginning of each working day to all oil holes marked "OIL."

"TYPE C" OIL should be used when an oil is desired which will produce a minimum of stain on fabrics, even after a long period of storage.

## INDEX

---

	Page
Accessories ... ..	49
Belt Guard ... ..	50
Bobbin Winder ... ..	49
Knee Lifter ... ..	50
Machine No. 451K11 ... ..	31
Machine No. 451K111 ... ..	40
Numerical List of Parts ... ..	53
Thread Unwinder... ..	51

## INSTRUCTIONS FOR ORDERING

In ordering from this List, the code number with the part number MUST BE quoted exactly as they are shown in the first column.

A number always indicates the same part in whatever List it may appear, or for whatever machine.

The code numbers (where shown) indicate the style of finish, as follows:—

Code No.	Style of Finishes
801	Hardened, Polished, Nickel Plated and Buffed.
802	Polished, Nickel Plated and Buffed.
803	Hardened only.
804	Polished only.
805	Soft, not Polished.
806	Hardened and Polished.
807	Bright Rumbled and Nickel Plated.
808	Blued.
809	Nickel Plated only.
810	Hardened and Nickel Plated.
811	Brass Plated.
812	Oxidized.
813	Phosphate Coating Formed on Surface of Iron or Steel.
814	Cadmium Plated.
815	Copper Plated.
816	Zinc Plated.
817	Silver Plated.
818	Polished and Nickel Plated.
819	Black Oxide for Iron and Steel.
820	Black Nickel Plated only.
821	Chromium Plated.
822	Buffed and Chromium Plated.
823	Hardened, Polished, Buffed and Chromium Plated.
824	Hardened, Bright Rumbled and Nickel Plated.
825	Hardened, Bright Rumbled, Nickel Plated, Bright Rumbled and Chromium Plated.
826	Alumilite (Plain).
827	Alumilite (Dyed). Colour must be stated.
828	Polished, Nickel Plated and Chromium Plated.
829	Hardened, Polished, Nickel Plated and Chromium Plated.
830	Heat Treated for Toughness.
831	Heat Treated for Toughness and Polished.
832	Heat Treated for Toughness and Nickel Plated.
833	Heat Treated for Toughness and Black Oxide.
834	Heat Treated for Toughness, Polished, Nickel Plated, Buffed and Chromium Plated.
835	Black Moulded Phenolic.
836	Beige Moulded Phenolic.
837	Brown Moulded Phenolic.
838	
839	Chrome Nickel, Satin Finish.
840	Hardened and Chrome Nickel, Satin Finish.
841	Hardened and Phosphate Coating Formed on Surface of Steel.
842	Hardened and Zinc Plated.
843	Hardened, Polished and Nickel Plated.
844	Hardened, Polished, Copper and Nickel Plated and Buffed.
845	Copper and Nickel Plated and Polished.
846	Copper and Nickel Plated only.
847	Hardened, Copper and Nickel Plated.

(Continued over

## INSTRUCTIONS FOR ORDERING—Continued.

Code No.	Style of Finishes.
848	Copper and Brass Plated.
849	Copper Plated and Oxidized.
850	Hardened and Black Oxide for Iron and Steel.
851	Hardened, Polished, Nickel Plated, Buffed and Chromium Plated.
852	Polished, Nickel Plated, Buffed and Chromium Plated.
853	Hardened and Chromium Plated.
854	Polished and Chromium Plated.
855	Bright Rumbled, Nickel Plated, Bright Rumbled and Chromium Plated.
856	Nickel and Chromium Plated.
857	Copper and Chromium Plated.
858	Heat Treated for Toughness, Nickel and Chromium Plated.
859	Heat Treated for Toughness, Copper Plated and Oxidized.
860	Nickel Plated and Buffed only.

Code No.	Paint Colours.	Code No.	Paint Colours.
701	Gloss Black.	724	Rosewood Brown.
702	Dull Black.	725	Light Bisque.
703	Brown.	726	Light Fawn.
704	Grey Wrinkle.	727	
705	Beige Wrinkle.	728	Grey Metallic.
706	Black Wrinkle.	729	Russet Brown.
707	Light Green.	730	Pale Green.
708	Dark Green.	731	Light Almond Green.
709	Dark Beige.	732	Dusty Bisque.
710	Light Beige.	733	Chocolate Brown.
711	Oyster White.	734	Pale Red.
712		735	Emerald Green.
713	Bright Cherry Red.	736	Green Metallic.
714	Light Ivory.	737	Light Beige Satin Matte.
715	Peacock Blue.	738	Copper Tan.
716	Bright Yellow.	739	Buff.
717	Slate Grey.	740	White.
718	Deep Brown.	741	Dark Fawn.
719		742	Plum.
720	Dark Brown.	743	Birch Brown.
721	Aluminium.	744	Satin Black.
722	Dark Grey.	745	Gold - Buff.
723	Light Grey Beige.	746	Blue-Grey

*Parts marked with an asterisk (\*) are furnished only when the repairs are made at Factory.*



# LIST OF PARTS COMPLETE

FOR

## MACHINE No. 451K11

SINGLE ROTARY THREAD TAKE-UP.

HAND OPERATED REVERSE FEED MECHANISM.

HIGH SPEED. LOCK STITCH. SINGLE NEEDLE. SHORT ARM.

FOR STITCHING LIGHT AND MEDIUM WEIGHT FABRICS.

No.	Plate	Name
*276441	—	Arm ... ..
276002	2845	" Cover (back) ... ..
200053(819)	2845	" " ( " ) Screw (2) ... ..
204235	2845	" Position Pin (2) ... ..
200004(805)	2845	" Screw (3) ... ..
202005	2845	" " Washer (3) ... ..
*276452	2846	" Shaft ... ..
276492	2846	" " 276452 with 200333(803), 200378(803), 272143, 272145, 276021 and 276023
272142	2846	" " Ball Bearing (back) ... ..
272143	2846	" " " " (front) ... ..
270926	2846	" " Connection Belt (reinforced neoprene) ... ..
271127	2846	" " " " Pulley with 200363(830), 350492(803) and two 214206
350492(803)	2846	" " " " Pulley Position Screw ... ..
200363(830)	2846	" " " " " Set Screw ... ..
214206	2846	" " " " " Spring Flange ... ..
*276187	—	Bed ... ..
276454	2838	" Plate ... ..
1423(806)	2838	" " Screw (2) ... ..
270009	2845	" Slide ... ..
276442	3008	Face Plate ... ..
276443	3008	" " 276442 with 276503 and two 141568(819) ... ..
276503	3008	" " Tension Guard ... ..
141568(819)	3008	" " " " Screw ... ..
350503(833)	3008	" " Screw (8) ... ..
272106	2840	Feed Bar ... ..
272107	2840	" " Hinge Pin ... ..
272112	2840	" " " " Lubricating Felt ... ..

No.	Plate	Name
200394(803)	2840	Feed Bar Hinge Pin Set Screw ...
272108	2840	" " " " Thrust Washer (2) ...
272109	2840	" " Lifting Crank with 200040(805) ...
200040(805)	2840	" " " " Pinch Screw ...
272110	2840	" " " " Link ...
200169(803)	—	" " " " Cap Screw (2) ...
272115	2840	" " " " Oiling Wick ...
272111	2840	" " " " " " Clamp ...
149126	2989	" Dog, 12 teeth (16 teeth to the inch) ...
208(830)	2989	" " Screw (2) ...
276153	2840	" Driving Connection ...
276154	2840	" " " " 276153 with 270016 (for agents only) ...
276230	2840	" " " " Crank with 200040(805) ...
350507(803)	2840	" " " " Hinge Screw ...
201531(805)	2840	" " " " " " Nut ...
200040(805)	2840	" " " " Pinch Screw ...
276169	2840	" " " " Link ...
276170	2840	" " " " " 276169 with 270653 (for agents only) ...
276171	2840	" " " " Hinge Pin with 244071 ...
244071	2840	" " " " " " Oil Packing (wick) ...
200394(803)	2840	" " " " " " Set Screw ...
270653	2840	" " " " Needle Bearing ...
270016	2840	" " " " Needle Bearing ...
270017	2844	" " Eccentric ...
276188	2844	" " Adjusting Disc ...
270137	2844	" " " " Spring ...
276009	2844	" " " " Collar with 201220(803) ...
201220(803)	2844	" " " " Collar Set Screw ...
240231	2844	" " Friction Gib ...
350578(850)	2844	" " Adjusting Screw ...
350562(850)	2844	" " " " Set Screw ...
276180	2844	" " Flange with 200333(803), 200346(803), two each 350562(850) and 350578(850) ...
200333(803)	2844	" " " " Position Screw ...
200346(803)	2844	" " " " Set Screw ...
272116	2840	" " Rock Shaft with two each 200394(803) and 270942 ...
270941	2840	" " " " Centre (2) ...
201254(803)	2840	" " " " Set Screw (2) ...
270942	2840	" " " " Insert (nylon) ...
270013	2840	" Lifting Connection ...
270014	2840	" " " " 270013 with 270016 ...

No.	Plate	Name
200545(803)	2840	Feed Lifting Connection Hinge Screw ...
201522(805)	2840	" " " " " " Nut ...
270016	2840	" " " " Needle Bearing ...
276231	2844	" " Eccentric with 200382(833) and 201220(803) ...
201220(803)	2844	" " " " Position Screw ...
200382(833)	2844	" " " " Set Screw ...
272118	2840	" " Rock Shaft with two 270942 ...
270941	2840	" " " " Centre (2) ...
201254(803)	2840	" " " " Set Screw (2) ...
270942	2840	" " " " Insert (nylon) ...
270140	2844	" Regulating Stud ...
240245	2844	" " " " Retaining Spring ...
270026	2844	" " " " Spring ...
276157	2840	" Reversing Lever with 350477(803) ...
276158	2840	" " " " Connection ...
201107(803)	2840	" " " " Hinge Screw (lower) ...
350509(803)	2840	" " " " " " (upper) ...
201520(819)	2840	" " " " " " ( " ) Nut ...
276160	2840	" " " " Handle ...
206575(819)	2840	" " " " Screw ...
201529(819)	2840	" " " " " " Nut ...
276159	2840	" " " " Hinge Pin ...
350477(803)	2840	" " " " Set Screw ...
350569(803)	2840	" " " " Stop Pin ...
201524(819)	2840	" " " " " " Nut ...
276181	2840	" " Mechanism Support Link ...
276182	2840	" " " " Stud ...
200346(803)	2840	" " " " Set Screw ...
276465	—	" " Shaft ...
276162	2840	" " " " Bushing (back) ...
276179	2840	" " " " (front) ...
200382(833)	2840	" " " " Set Screw (2) ...
276163	2840	" " " " Crank with 200040(805) and 200386(863) ...
276164	2840	" " " " Hinge Stud with 276046 ...
276046	2840	" " " " Oil Packing (wick) ...
200386(803)	2840	" " " " Set Screw ...
276165	2840	" " " " Link with 200394(803) ...
200040(805)	2840	" " " " Pinch Screw ...
276456	—	" " " " Spring ...
276457	—	" " " " Adjusting Collar with two 200092(806) ...
200092(806)	2840	" " " " " " Set Screw ...

No.	Plate	Name
276014	2842	Knee Lifter Lifting Link ...
200293(830)	2842	" " " " Hinge Screw ...
276015	2845	" " " " Rod with 262302 ...
202302	2845	" " " " Cotter Pin ...
276016	2845	" " " " Spring ...
227227	2845	" " " " " Collar with 200113(806) ...
200113(806)	2845	" " " " " " Set Screw ...
276017	2845	" " Rock Frame ...
200679(806)	2845	" " " " Hinge Screw (back) ...
200272(803)	2845	" " " " " " (front) ...
147211	2837	Knife (upper) ...
270620	2837	" ( " ) Driving Connection ...
270621	2837	" ( " ) " " 270620 with 268063 and 270653 ...
276458	2837	" ( " ) " " Crank with 290190(804) ...
270623	2837	" ( " ) " " Hinge Stud ...
292574	2837	" ( " ) " " " Collar with 200380(803) ...
200380(803)	2837	" ( " ) " " Hinge Stud Collar Set Screw ...
200347(830)	2837	" ( " ) " " Stud Set Screw ...
276459	2837	" ( " ) " " Oil Guard ...
201048(819)	2837	" ( " ) " " Thumb Screw ...
200190(804)	2837	" ( " ) " " Pinch Screw ...
268063	2837	" ( " ) " " Needle Bearing (upper) ...
270653	2837	" ( " ) " " " (lower) ...
270625	2846	" ( " ) " Eccentric with two 200346(803) ...
270626	2846	" ( " ) " " Cap Washer ...
200346(803)	2846	" ( " ) " " Set Screw ...
270627	2837	" ( " ) " Link (lower half) with 200136(804) ...
201185(804)	—	" ( " ) " " ( " " ) Retaining Screw ...
270629	2837	" ( " ) " " (upper half) ...
270630	2837	" ( " ) " " ( " " ) Hinge Stud ...
270631	2837	" ( " ) " " ( " " ) Locking Plunger ...
203213	2837	" ( " ) " " ( " " ) " " Spring ...
270632	2837	" ( " ) " " Hinge Pin ...
200136(804)	2837	" ( " ) " " " Set Screw ...
276460	2837	" ( " ) Holder ...
200380(803)	2837	" ( " ) " Adjusting Screw ...
276461	2837	" ( " ) " Bracket with 201320(804) and 201537(819) ...
201320(804)	2837	" ( " ) " " Adjusting Screw ...
201537(819)	2837	" ( " ) " " " Nut ...

No.	Plate	Name
270637	2837	Knife (upper) Holder Bracket Latch ...
200130(806)	2837	" ( " ) " " " Screw ...
276462	—	" ( " ) " " Stud with 268258 ...
430(830)	—	" ( " ) " " Binding Screw ...
268258	2837	" ( " ) " " Oil Packing (wick) ...
200077(805)	2837	" ( " ) " " Screw ...
292101	2837	" ( " ) " " Washer ...
223(809)	2837	" ( " ) Screw (2) ...
2291	2837	" ( " ) " Washer ...
276444	—	Machine Pulley (aluminium alloy casting) for "V" belt (outside diam. of belt groove 2.9 in., rim diam. 4 in.) with 141566(803) and 141567(803) ...
276445	—	Machine Pulley 276444 with 272142 ...
141566(803)	—	" " Position Screw ...
141567(803)	—	" " Set Screw ...
88 X 9 Y	—	Needle, size 14 (Catalogue No. 1361) ...
270656	2842	Needle Bar with 350621(830) ...
270124	2842	" " Bushing (lower) ...
270261	2842	" " " (upper) ...
350550(830)	2842	" " " ( " ) Set Screw ...
*276018	2842	" " Connecting Link ...
276019	2842	" " " " 276018 with 270266 ...
270055	2842	" " " " Guide Block ...
200054(805)	2842	" " " " " " Screw (2) ...
272206	2842	" " " " Hinge Stud with 270161 ...
276021	2846	" " " " " Oiling Felt ...
272145	2846	" " " " " " " " " " Flange ...
276053	2846	" " " " " " " " " " Oil Leader Tube ...
200374(830)	2846	" " " " " " " " Set Screw ...
270266	2842	" " " " " Needle Bearing ...
270305	2842	" " " " " Thrust Washer ...
270957	2842	" " " " Stud with 202277 and 350622(833) ...
202277	2842	" " " " " Oil Packing (wick) ...
350622(833)	2842	" " " " " Pinch Screw ...
*276023	2846	" " Crank with two 200374(830) ...
200333(803)	2846	" " " " Position Screw ...
200378(803)	2846	" " " " " Check Screw ...
270058	2842	" " Oiling Felt ...
350621(830)	2842	" Set Screw ...
272121	2842	Presser Bar with 176(819) ...
276025	2842	" " Ball, $\frac{3}{8}$ " diameter ...
276446	2842	" " Bushing ...

No.	Plate	Name
276027	2842	Presser Bar Lifter ... ..
350442(803)	2842	" " " Hinge Screw ... ..
276028	2842	" " Lifting Releasing Lever Bracket ... ..
272122	2842	" " Position Guide with 350411(803) ... ..
350411(803)	2842	" " " " Pinch Screw ... ..
272123	2845	" " Spring ... ..
350435(803)	2845	" " " Screw (Pressure Regulating) ... ..
350499(850)	2845	" " " " Stud ... ..
26276	3009	" Foot Hinge Pin ... ..
276472	3009	" " Plate for 276474 ... ..
276473	2989	" " " " 276475 ... ..
24727	2989	" " Shank ... ..
276474	3009	Presser Foot (hinged) complete, 46 needle hole, in trimming margins from $\frac{1}{8}$ " to $\frac{1}{16}$ ", in steps of $\frac{1}{32}$ ", Nos. 24727, 26276 and 276472 ... ..
276475	2989	Presser Foot (hinged) complete, 46 needle hole, in $\frac{1}{8}$ " and $\frac{1}{16}$ " trimming margins, Nos. 24727, 26276 and 276472 ... ..
<i>NOTE.—No. 276175, <math>\frac{1}{8}</math>" trimming margin, is sent with the machine unless otherwise specified on order.</i>		
176(819)	2842	Presser Foot Screw ... ..
272207	2995	Pre-Tension Bracket with 200397(819) ... ..
350552(819)	2995	" " Screw ... ..
210993	2995	" Sleeve ... ..
272208	2995	" Spring ... ..
272209	2995	" Stud ... ..
210958	2995	" Collar ... ..
200397(819)	2995	" " " Set Screw ... ..
272210	2995	Pre-Tension Bracket, complete, Nos. 210958, 210993, and 272207 to 272209 ... ..
272211	3008	Rotary Take-up ... ..
272212	3008	" " Counterbalance Rivet ... ..
276506	3008	" " Guard ... ..
276507	3008	" " " Cover ... ..
276038	3008	" " " Grill ... ..
200161(819)	2841	" " " " Screw ... ..
200263(850)	3008	" " " " Hinge Screw ... ..
67425	3008	" " " " " Spring Washer ... ..
230743(803)	3008	" " " " " Thrust Washer ... ..
276508	3008	" " " " " Spring Catch ... ..
350503(819)	3008	" " " " " Screw ... ..
201537(805)	3008	" " " " " Nut ... ..
141569(819)	3008	" " " " " Screw (long) ... ..
141570(819)	3008	" " " " " (short) ... ..
272216	3008	" " " " Thread Shield ... ..
272217	3008	" " Mounting Disc with three 272212 ... ..

No.	Plate	Name
270161	3008	Rotary Take-up Mounting Disc Position Pin ... ..
200577(830)	3008	" " Screw (2) ... ..
272136	2839	Rotating Hook with 143301, 270878 and two 1253(830) ... ..
272137	2839	" " 272136 with 270874(806) and four 1053(805) ... ..
272138	2839	" " 272137 with 270872, 272132 and three 1367(805) ... ..
272139	2839	" " 272138 with 52237 ... ..
270010	2839	" Bobbin ... ..
52235	2839	" " Case ... ..
52236	2839	" " " " 52235 with 591(806), 1380(805) and 40394 ... ..
40393	2839	" " " " Hinge, Nos. 2974, 40392 and 125320 ... ..
270872	2839	" " " " Holder (chromium plated) ... ..
272131	2839	" " " " Position Bracket ... ..
200077(804)	2839	" " " " " " " Screw ... ..
40392	2839	" " " " Latch ... ..
125320	2839	" " " " Lever ... ..
2974	2839	" " " " Fulcrum Pin ... ..
2975	2839	" " " " Spring ... ..
592(805)	2839	" " " " Stop Screw ... ..
40394	2839	" " " " Tension Spring ... ..
591(806)	2839	" " " " " " " Regulating Screw ... ..
1380(805)	2839	" " " " " " " Screw ... ..
52237	2839	" " " " complete, Nos. 592(805), 2975, 40393 and 52236 ... ..
270873	2839	" " " " 52237 with 270872 (for agents only) ... ..
276044	2844	" " Driving Shaft ... ..
272144	2844	" " " " Ball Bearing ... ..
276045	2844	" " " " Bushing with 276046 ... ..
276046	2844	" " " " Oil Packing (wick) ... ..
200346(803)	2844	" " " " Set Screw ... ..
270169	2844	" " " " Connection Belt Pulley with 214206 and two 200070(803) ... ..
200070(803)	2844	" " " " Connection Belt Pulley Set Screw ... ..
214206	2844	" " " " " " " Spring Flange ... ..
276047	2844	" " " " Gear (internal teeth) with 200382(833) and 201220(803) ... ..
201220(803)	2844	" " " " Gear Position Screw ... ..
200382(833)	2844	" " " " Set Screw ... ..
270036	2844	" " " " Oil Lead Wire ... ..

No.	Plate	Name
270879	2839	Rotating Hook Oil Guard ... ..
276177	2845	" " " Reservoir Cover ... ..
276491	2845	" " " " " Gasket ... ..
200041(819)	2845	" " " " " Screw (6) ... ..
272154	—	" " " " " Washer (fibre) (6) ... ..
270878	2839	" " " Retaining Washer (felt) ... ..
143301	2839	" " " Wick (felt) ... ..
272132	2839	" " Section ... ..
1367(805)	2839	" " " Screw ... ..
1253(830)	2839	" " Set Screw ... ..
276059	2844	" " Shaft ... ..
272228	2844	" " " Bushing ... ..
270880	2844	" " " " Oil Packing (wick) ... ..
200346(803)	2844	" " " " Set Screw ... ..
270164	2844	" " " End Bearing ... ..
201215(804)	2844	" " " " " Screw ... ..
202423	2844	" " " Oil Filter Wick ... ..
276061	2844	" " " " " Holder ... ..
276062	2844	Rotating Hook Shaft Oil Filter, complete, Nos. 202423 and 276061
350498(805)	2844	Rotating Hook Shaft Oil Regulating Screw ... ..
270044	2844	" " " Thrust Washer ... ..
272229	2844	Rotating Hook Shaft Bushing, complete, Nos. 270044, 270164, 270880, 272228, 276059, 276062, 350498(805) and two 201215(804) ... ..
270874(806)	2839	Rotating Hook Thread Guard ... ..
1053(805)	2839	" " " " " Screw ... ..
276048	2842	Tension Releaser (adjustable) ... ..
200132(805)	2842	" " " Screw ... ..
272218	2995	" Releasing Disc ... ..
270086	2995	" " Pin ... ..
272219	2995	" Spring ... ..
50304(806)	2995	" Stud ... ..
276225	2995	" " 50304(806) with 272220 ... ..
50305(803)	2995	" " Set Screw ... ..
1560(803)	2995	" Thumb Nut... ..
272220	2995	" Washer ... ..
272221	2995	" Wheel ... ..
202079	2995	" " Washer (felt) ... ..
272222	2995	Tension (rotary) complete, Nos. 1560(803), 52083, 270086, 272218, 272219, 272221, 272225, 276225 and two 202079
276447	3008	Tension (rotary) Threading Guide ... ..
350503(819)	3008	" ( " ) " " Screw ... ..
272223	3008	Thread Cutter (on Face Plate) ... ..
200583(819)	—	" " ( " " " ) Screw ... ..

No.	Plate	Name
272224	3008	Thread Cutter (on Rotary Take-up Guard) ... ..
200904(819)	3008	" " ( " " " " ) Screw ... ..
276051	3008	" Guide ... ..
276464	2842	" " (on Needle Bar Bushing) ... ..
350503(833)	3008	" " Screw ... ..
276057	2842	" Pull-off ... ..
200145(830)	2842	" " Screw (2) ... ..
272225	2995	" Take-up Spring ... ..
52083	2841	" " " Regulator with 50305(803) ... ..
453(850)	2841	" " " " Set Screw ... ..
276466	2989	Throat Plate Body ... ..
147262	2989	" " Cutting Bar for 276468 ... ..
147269	—	" " " " " 276470 ... ..
147274	—	" " " " " 276469 ... ..
578(804)	—	" " " " " Screw for 276470 ... ..
50438(804)	2989	" " " " " 276468 and 276469 ... ..
276467	2989	" " Slide for 276468 ... ..
147267	—	" " " " " 276470... ..
147272	—	" " " " " 276469... ..
236(804)	—	" " " " " Screw for 276470 ... ..
50438(804)	2989	" " " " " 276468 and 276469 ... ..
276468	2989	Throat Plate, complete, 46 needle hole, in trimming margins from $\frac{1}{8}$ " to $\frac{1}{4}$ ", in steps of $\frac{1}{16}$ ", Nos. 147262, 276466, 276467 and three 50438(804) for 149126 ... ..
276469	—	Throat Plate, complete, 46 needle hole, in $\frac{3}{16}$ " trimming margin, Nos. 147272, 147274, 276466 and three 50438(804) for 149126 ... ..
276470	—	Throat Plate, complete, 46 needle hole, in $\frac{5}{16}$ " trimming margin, Nos. 236(804), 147267, 147269, 276466 and two 578(804) for 149126 ... ..
NOTE.—No. 276468, $\frac{1}{8}$ " trimming margin, is sent with this machine unless otherwise specified on order.		
1454(806)	2989	Throat Plate Screw (2) ... ..
228478	18311	Drip Pan with four $\frac{3}{4}$ " wire nails ... ..

# MACHINE No. 451K111

SINGLE ROTARY THREAD TAKE-UP.

HAND OPERATED REVERSE FEED MECHANISM.

HIGH SPEED. LOCK STITCH. SINGLE NEEDLE. LONG ARM.  
FOR STITCHING LIGHT AND MEDIUM WEIGHT FABRICS.

No.	Plate	Name
*276476	—	Arm ... ..
276002	2845	" Cover (back) ... ..
200053(819)	2845	" " ( " ) Screw (2) ... ..
204235	2845	" Position Pin (2) ... ..
200004(805)	2845	" Screw (3) ... ..
262005	2845	" " Washer (3) ... ..
*276477	2847	" Shaft ... ..
276493	2847	" " 276477 with 266333(803), 266378(803), 272143, 272145, 276113 and 276115
272142	2847	" " Ball Bearing (back) ... ..
272143	2847	" " " " (front) ... ..
270926	2847	" " Connection Belt (reinforced neoprene) ... ..
271127	2847	" " " " Pulley with 260363(830), 350492(803) and two 214206
350492(803)	2847	" " " " Pulley Position Screw ... ..
260363(830)	2847	" " " " " Set Screw ... ..
214206	2847	" " " " " Spring Flange ... ..
*276152	—	Bed ... ..
276454	2838	" Plate ... ..
1423(806)	2838	" " Screw (2) ... ..
270009	2845	" Slide ... ..
276240	2841	Face Plate with 276054 and four 200586(819) ... ..
276054	2841	" " Thread Guard ... ..
200586(819)	2841	" " " " Screw ... ..
350503(833)	2841	" " " " Screw (8) ... ..
272106	2840	Feed Bar ... ..
272107	2840	" " Hinge Pin ... ..
272112	2840	" " " " Lubricating Felt ... ..
200394(803)	2840	" " " " Set Screw ... ..
272108	2840	" " " " Thrust Washer (2) ... ..
272109	2840	" " Lifting Crank with 200040(805) ... ..
200040(805)	2840	" " " " Pinch Screw ... ..

# PARTS FOR MACHINE No. 451K111

No.	Plate	Name
272110	2840	Feed Bar Lifting Link ... ..
200169(803)	—	" " " " Cap Screw (2) ... ..
272115	2840	" " " " Oiling Wick ... ..
272111	2849	" " " " " " Clamp ... ..
149025	3009	" Dog, 9 teeth (12 teeth to the inch) ... ..
208(830)	2989	" " Screw (2) ... ..
276153	2840	" Driving Connection ... ..
276154	2840	" " " 276153 with 270016 (for agents only)
276230	2840	" " " Crank with 200040(805) ... ..
350507(803)	2840	" " " " Hinge Screw ... ..
201531(805)	2840	" " " " " " Nut ... ..
200040(805)	2840	" " " " Pinch Screw ... ..
276169	2840	" " " Link ... ..
276170	2840	" " " " 276169 with 270653 (for agents only)
276171	2840	" " " " Hinge Pin with 244071 ... ..
244071	2840	" " " " " " Oil Packing (wick)
200394(803)	2840	" " " " " " Set Screw ... ..
270653	2840	" " " " Needle Bearing ... ..
270916	2840	" " " Needle Bearing ... ..
270017	2844	" " Eccentric ... ..
276155	2844	" " " Adjusting Disc ... ..
270137	2844	" " " " " Spring ... ..
270111	2844	" " " " " " Collar with 201220(803)
201220(803)	2844	" " " " " " Collar Set Screw
240231	2844	" " " Friction Gib ... ..
350578(850)	2844	" " " " " Adjusting Screw ... ..
350562(850)	2844	" " " " " " " Set Screw
276180	2844	" " Flange with 200333(803), 200346(803), two each 350562(850) and 350578(850)
200333(803)	2844	" " " Position Screw ... ..
200346(803)	2844	" " " Set Screw ... ..
272116	2840	" " Rock Shaft with two each 200394(803) and 270942
270941	2840	" " " " Centre (2) ... ..
201254(803)	2840	" " " " " Set Screw (2) ... ..
270942	2840	" " " " " Insert (nylon) ... ..
270013	2840	" Lifting Connection ... ..
270014	2840	" " " 270013 with 270016 ... ..
200545(803)	2840	" " " Hinge Screw ... ..
201522(805)	2840	" " " " " Nut ... ..
270016	2840	" " " Needle Bearing ... ..

No.	Plate	Name
276231	2844	Feed Lifting Eccentric with 200382(833) and 201220(803)
201220(803)	2844	" " " Position Screw ...
200382(833)	2844	" " " Set Screw ...
272118	2840	" " Rock Shaft with two 270942
270941	2840	" " " " Centre (2) ...
201254(803)	2840	" " " " " Set Screw (2) ...
270942	2840	" " " " Insert (nylon) ...
270140	2844	" Regulating Stud ...
240245	2844	" " " Retaining Spring ...
270026	2844	" " " Spring ...
276157	2840	" Reversing Lever with 350477(803)
276158	2840	" " " Connection ...
201107(803)	2840	" " " " Hinge Screw (lower) ...
350509(803)	2840	" " " " " " (upper) ...
201520(819)	2840	" " " " " " ( " )Nut
276160	2840	" " " Handle ...
200575(819)	2840	" " " " Screw ...
201529(819)	2840	" " " " " Nut ...
276159	2840	" " " Hinge Pin ...
350477(803)	2840	" " " " Set Screw ...
350569(803)	2840	" " " Stop Pin ...
201524(819)	2840	" " " " " Nut ...
276181	2840	" " Mechanism Support Link ...
276182	2840	" " " " Stud ...
200346(803)	2840	" " " " Set Screw ...
276479	2840	" " Shaft ...
276162	2840	" " " Bushing (back) ...
276179	2840	" " " " (front) ...
200382(833)	2840	" " " " Set Screw (2) ...
276163	2840	" " " Crank with 200040(805) and 200386(803)
276164	2840	" " " " Hinge Stud with 276046 ...
276046	2840	" " " " " Oil Packing (wick) ...
200386(803)	2840	" " " " Set Screw ...
276165	2840	" " " Link with 200394(803) ...
200040(805)	2840	" " " " Pinch Screw ...
276166	2840	" " " Spring ...
276167	2840	" " " Adjusting Collar with two 200092(806)
200092(806)	2840	" " " " " Set Screw ...
270256	2843	Knee Lifter Lifting Link ...
200293(830)	2843	" " " " Hinge Screw ...
276015	2845	" " " Rod with 202302 ...
202302	2845	" " " " Cotter Pin ...
276016	2845	" " " " Spring ...
227227	2845	" " " " Collar with 200113(806) ...

No.	Plate	Name
200113(806)	2845	Knee Lifter Lifting Rod Spring Collar Set Screw ...
276109	2845	" " Rock Frame ...
200679(806)	2845	" " " " Hinge Screw (back) ...
200272(803)	2845	" " " " " " (front) ...
276489	—	Knife (upper) ...
270620	2837	" ( " ) Driving Connection ...
270621	2837	" ( " ) " " 270620 with 268063 and 270653
276458	2837	" ( " ) " " Crank with 200190(804)
270623	2837	" ( " ) " " Hinge Stud ...
202574	2837	" ( " ) " " " " Collar with 200380(803)
200380(803)	2837	" ( " ) " " Hinge Stud Collar Set Screw
200347(830)	2837	" ( " ) " " Stud Set Screw
276459	2837	" ( " ) " " Oil Guard ...
201048(819)	2837	" ( " ) " " " Thumb Screw
200190(804)	2837	" ( " ) " " Pinch Screw ...
268063	2837	" ( " ) " " Needle Bearing (upper)
270653	2837	" ( " ) " " " (lower)
276480	2847	" ( " ) " Eccentric with two 200346(803) ...
270626	2847	" ( " ) " Cap Washer ...
200346(803)	2847	" ( " ) " Set Screw ...
270627	2837	" ( " ) " Link (lower half) with 200136(804)
201185(804)	—	" ( " ) " " ( " ) Retaining Screw
270629	2837	" ( " ) " " (upper half) ...
270630	2837	" ( " ) " " ( " ) Hinge Stud ...
270631	2837	" ( " ) " " ( " ) Locking Plunger
203213	2837	" ( " ) " " ( " ) " Spring
270632	2837	" ( " ) " " Hinge Pin ...
200136(804)	2837	" ( " ) " " " Set Screw ...
276460	2837	" ( " ) Holder ...
200380(803)	2837	" ( " ) " Adjusting Screw ...
276461	2837	" ( " ) " Bracket with 201320(804) and 201537(819)
201320(804)	2837	" ( " ) " " Adjusting Screw ...
201537(819)	2837	" ( " ) " " " Nut ...
270637	2837	" ( " ) " " Latch ...
200130(806)	2837	" ( " ) " " Screw ...
276481	2837	" ( " ) " Stud with 268258 ...
430(830)	—	" ( " ) " " Binding Screw ...
268258	2837	" ( " ) " " Oil Packing (wick) ...
200077(805)	2837	" ( " ) " Screw ...

No.	Plate	Name
202101	2837	Knife (upper) Holder Screw Washer ... ..
223(809)	2837	" ( " ) Screw (2) ... ..
2291	2837	" ( " ) " Washer ... ..
276175	2847	Machine Pulley (aluminium alloy casting) for "V" belt (outside diam. of belt groove 2.9 in., rim diam. 4½ in.) with 350540(803) and 350541(803) ... ..
276176	2847	Machine Pulley 276175 with 272142 ... ..
350540(803)	2847	" " Position Screw ... ..
350541(803)	2847	" " Set Screw ... ..
135 x 25 Y	—	Needle, size 16 (Catalogue No. 1968) ... ..
276482	2843	Needle Bar with 350621(830) ... ..
276111	2843	" " Bushing (lower) ... ..
270855	2843	" " " (upper) ... ..
350550(830)	2843	" " ( " ) Set Screw ... ..
*270262	2843	" " Connecting Link ... ..
270263	2843	" " " " 270262 with 270266 ... ..
270264	2843	" " " " Guide Block ... ..
200054(805)	2843	" " " " " " Screw (2) ... ..
276112	2843	" " " " Hinge Stud ... ..
276113	2847	" " " " " " Oiling Felt ... ..
272145	2847	" " " " " " " " " " Oil
276053	2847	" " " " " " " " " " Flange
		Leader Tube
200374(830)	2847	" " " " " " Set Screw ... ..
270266	2843	" " " " Needle Bearing ... ..
276114	2843	" " " " Thrust Washer ... ..
270856	2843	" " " " Stud with 202277 and 350622(833) ... ..
202277	2843	" " " " Oil Packing (wick) ... ..
350622(833)	2843	" " " " Pinch Screw ... ..
*276115	2847	" " Crank with two 200374(830) ... ..
200333(803)	2847	" " " Position Screw ... ..
200378(803)	2847	" " " " " Check Screw ... ..
270058	2843	" " Oiling Felt ... ..
350621(830)	2843	" Set Screw ... ..
276241	2843	Presser Bar with 176(819) ... ..
276025	2843	" " Ball, ½" diameter ... ..
276483	2843	" " Bushing ... ..
276117	2843	" " Lifter ... ..
350442(803)	2843	" " " Hinge Screw ... ..
276028	2843	" " Lifting Releasing Lever Bracket ... ..
272122	2843	" " Position Guide with 350411(803) ... ..
350411(803)	2843	" " " " Pinch Screw ... ..

No.	Plate	Name
276242	2845	Presser Bar Spring ... ..
350435(803)	2845	" " " Screw (Pressure Regulating) ... ..
350499(850)	2845	" " " " Stud ... ..
26276	3009	" Foot Hinge Pin ... ..
276472	3099	" " Plate for 276474 ... ..
276473	2989	" " " " 276475 ... ..
24727	3009	" " Shank ... ..
276474	3009	Presser Foot (hinged) complete, 46 needle hole, in trimming margins from ⅜" to ⅝", in steps of ⅛", Nos. 24727, 26276 and 276472 ... ..
276475	2989	Presser Foot (hinged) complete, 46 needle hole, in ¼" and ⅜" trimming margins, Nos. 24727, 26276 and 276473 ... ..
NOTE.—No. 276475, ¼" trimming margin, is sent with this machine unless otherwise specified on order.		
176(819)	2843	Presser Foot Screw ... ..
276120	2841	Rotary Take-up ... ..
276121	2841	" " Adjusting Disc ... ..
276122	—	" " " " 276121 with 276123 and two 350503(833) ... ..
276034	2841	" " Clamping Plate ... ..
200567(819)	2841	" " " " Screw (2) ... ..
276123	2841	" " Counterbalance ... ..
350503(833)	2841	" " " Screw ... ..
276471	2841	" " Guard ... ..
200031(819)	2841	" " " Screw (long) ... ..
200069(819)	2841	" " " " (short) ... ..
276228	2841	" " " Cover ... ..
276038	2841	" " " " Grill ... ..
260161(819)	2841	" " " " " Screw ... ..
200263(850)	2841	" " " " Hinge Screw ... ..
67425	2841	" " " " " " Spring Washer ... ..
230743(803)	2841	" " " " " " Thrust Washer ... ..
276229	2841	" " " " " Spring Catch ... ..
350503(819)	2841	" " " " " " Screw ... ..
201537(805)	2841	" " " " " " " " Nut ... ..
200685(803)	2841	" " " " Thread Guide Screw ... ..
200577(830)	2841	" " " Screw (3) ... ..
276043	2841	" " Spacer ... ..
272136	2839	Rotating Hook with 143301, 270878 and two 1253(830) ... ..
272137	2839	" " " 272136 with 270874(806) and four 1053(805) ... ..
272138	2839	" " " 272137 with 270872, 272132 and three 1367(805) ... ..
272139	2839	" " " 272138 with 52237 ... ..



## PARTS FOR MACHINE No. 451K111

No.	Plate	Name
270010	2839	Rotating Hook Bobbin
52235	2839	" " " Case
52236	2839	" " " " 52235 with 591 (806), 1380(805) and 40394
40393	2839	" " " " Hinge, Nos. 2974, 40392 and 125320
270872	2839	" " " " Holder (chromium plated)
272131	2839	" " " " " Position Bracket
200077(804)	2839	" " " " " " " Screw
40392	2839	" " " " " Latch
125320	2839	" " " " " Lever
2974	2839	" " " " " Fulcrum Pin
2975	2839	" " " " " Spring
592(805)	2839	" " " " " Stop Screw
40394	2839	" " " " " Tension Spring
591(806)	2839	" " " " " " " Regulating Screw
1380(805)	2839	" " " " " " " Screw
52237	2839	" " " " " complete, Nos. 592(805), 2975, 40393 and 52236
270873	2839	" " " " " 52237 with 270872 (for agents only)
276125	2844	" " " " " Driving Shaft...
272144	2844	" " " " " Ball Bearing
276045	2844	" " " " " Bushing with 276046
276046	2844	" " " " " Oil Packing (wick)
200346(803)	2844	" " " " " Set Screw
270169	2844	" " " " " Connection Belt Pulley with 214206 and two 200070(803)
200070(803)	2844	" " " " " Connection Belt Pulley Set Screw
214206	2844	" " " " " " " " " Spring Flange
276047	2844	" " " " " Gear (internal teeth) with 200382(833) and 201220(803)
201220(803)	2844	" " " " " Gear Position Screw
200382(833)	2844	" " " " " " Set Screw
270036	2844	" " " " " Oil Lead Wire
270879	2839	" " " " " Oil Guard
276177	2845	" " " " " Reservoir Cover
276491	2845	" " " " " " Gasket
200041(819)	2845	" " " " " " Screw (6)
272154	—	" " " " " " Washer (fibre) (6)
270878	2839	" " " " " Retaining Washer (felt)
143301	2839	" " " " " Wick (felt)
272132	2839	" " " " " Section

## PARTS FOR MACHINE No. 451K111

No.	Plate	Name
1367(805)	2839	Rotating Hook Section Screw
1253(830)	2839	" " " Set Screw
276059	2844	" " " Shaft
270163	2844	" " " Bushing
270880	2844	" " " " Oil Packing (wick)
200346(803)	2844	" " " " Set Screw
270164	2844	" " " End Bearing
201215(804)	2844	" " " " " Screw
202423	2844	" " " Oil Filter Wick
276061	2844	" " " " " " Holder
276062	2844	Rotating Hook Shaft Oil Filter, complete, Nos. 202423 and 276061
350498(805)	2844	Rotating Hook Shaft Oil Regulating Screw
270044	2844	" " " Thrust Washer
276060	2844	Rotating Hook Shaft Bushing, complete, Nos. 270044, 270163, 270164, 270880, 276059, 276062, 350498(805) and two 201215(804)
270874(806)	2839	Rotating Hook Thread Guard
1053(805)	2839	" " " " " Screw
2102	2841	Tension Disc
276048	2843	" Releaser (adjustable)
200132(805)	2843	" " Screw
32572	2841	" Releasing Disc
270086	2841	" " Pin
13710	2841	" Spring
50304(803)	2841	" Stud
52098	2841	" " 50304(803) with 1560(803)
50305(803)	2841	" " Set Screw
276055	2841	" Thread Guide Pin
1560(803)	2841	" Thumb Nut...
276049	2841	Tension, complete, Nos. 13710, 32572, 39652, 52083, 52098, 270086 and two 2102
276050	2841	Thread Cutter
200583(819)	2841	" " Screw
276051	2841	" Guide
276464	2843	" " (on Needle Bar Bushing)
350503(833)	2841	" " Screw
276118	—	" Pull-off
200145(830)	2843	" " Screw (2)
276052	2841	" Retainer (front)
200397(819)	2841	" " ( " ) Set Screw
270080	2841	" " (rear)
200366(819)	2841	" " ( " ) Set Screw

No.	Plate	Name
39652	2841	Thread Take-up Spring ... ..
52083	2841	" " " " Regulator with 50305(803) ... ..
453(850)	2841	" " " " " Set Screw ... ..
276485	3009	Throat Plate Body ... ..
147262	3009	" " " " Cutting Bar for 276486 ... ..
147269	—	" " " " " " 276488 ... ..
147274	—	" " " " " " 276487 ... ..
578(804)	—	" " " " " " Screw for 276488 ... ..
50438(804)	3009	" " " " " " " 276486 and 276487 ... ..
127035	3009	" " " " Slide for 276486... ..
147267	—	" " " " " " 276488... ..
147272	—	" " " " " " 276487... ..
236(804)	—	" " " " " " Screw for 276488 ... ..
50438(804)	3009	" " " " " " " 276486 and 276487 ... ..
276486	3009	Throat Plate, complete, 46 needle hole, in trimming margins from $\frac{1}{8}$ " to $\frac{1}{4}$ " in steps of $\frac{1}{32}$ ", Nos. 127035, 147262, 276485 and three 50438(804) for 149025 ... ..
276487	—	Throat Plate, complete, 46 needle hole, in $\frac{5}{16}$ " trimming margin, Nos. 147272, 147274, 276485 and three 50438(804) for 149025 ... ..
276488	—	Throat Plate, complete, 46 needle hole, in $\frac{3}{16}$ " trimming margin, Nos. 236(804), 147267, 147269, 276485 and two 578(804) for 149025 ... ..
1454(806)	2989	Throat Plate Screw (2) ... ..
228479	18333	Drip Pan with four $\frac{3}{4}$ " wire nails ... ..

NOTE.—No. 276486,  $\frac{1}{8}$ " trimming margin, is sent with this machine unless otherwise specified on order.

## ACCESSORIES

No.	Plate	Name
12361	2848	Machine Hinge Connection (2) ... ..
41400	2848	" " Rest Pin (wood) ... ..
88 x 9 Y	—	Needles, six, size 16, (Catalogue No. 1361) for 451K11 Machine
135 x 25 Y	—	" " " " 16, (Catalogue No. 1968) for 451K111 Machine ... ..
120342	2848	Oiler (copper plated) with 120343 ... ..
120343	2848	" " Spout ( $3\frac{1}{4}$ " long) ... ..
270010	2839	Rotating Hook Bobbin (2) ... ..
270155	2844	" " " Oil Reservoir Oil Gauge ... ..
120378	2848	Screw Driver (bobbin case) ... ..
85318	2848	Screw Driver ... ..
86698	—	Tin of Oil ( $\frac{1}{2}$ pint) ... ..
240566	—	Wrench ... ..

## PRESSER FOOT

(for General Work)

(only supplied when specified on order, and at an extra charge)

No.	Plate	Name
86659	3009	Presser Foot Plate ... ..
86660	3009	" " Shank ... ..
86661	3009	Presser Foot (hinged), complete, Nos. 86659 and 86660 ... ..

## BOBBIN WINDER

(Swinging Automatic, Right Hand)

For "V" Belt Drive

No.	Plate	Name
259428	2624	Brake (leather) ... ..
259429	2624	" " Clamp ... ..
200113(806)	2624	" " " Screw ... ..
225453	2624	Frame with 244071 and 259660 ... ..
225454	2624	" " Hinge Pin ... ..
244071	2624	" " Oil Packing (wick) ... ..
259660	2624	" " " Well Washer ... ..
225455	2624	" " Spring ... ..
225456	2624	" " " Plunger ... ..
104211	2624	Pulley with 200380(803) ... ..
200380(803)	2624	" " Set Screw ... ..
225381	2624	Spindle ... ..

## ACCESSORIES

No.	Plate	Name
225444	2624	Stop Latch ...
200056(805)	2624	" " Screw ...
225458	2624	" " Thumb Lever ...
225459	2624	" " " " Hinge Stud ...
225459	2624	" " " " Joint Stud ...
202478	2624	" " Trip Lever ...
200299(808)	2624	" " " " Hinge Screw ...
225461	2624	Tension Bracket with 201499(808) ...
200082(804)	2624	" " Screw ...
228026	2624	" " " Washer ...
2102	2624	" Disc ...
13710	2624	" Spring ...
201499(808)	2624	" Stud ...
201572(808)	2624	" " Thumb Nut ...
225462	2624	Bobbin Winder Tension Bracket, complete, Nos. 13710, 201572(808), 225461 and two 2102 ...
259430	2624	Bobbin Winder and Tension Bracket Base ...
104212	2624	Bobbin Winder (swinging automatic, right hand), complete, Nos. 104211, 200056(805), 200082(804), 200113(806), 200299(808), 202478, 225381, 225444, 225453 to 225456, 225458, 225462, 228026, 259428 to 259430, two each 225459 and wood screws $\frac{3}{8}$ " No. 12 R.H.B. ...

## BELT GUARD

(only supplied when specified on order, and at an extra charge).

No.	Plate	Name
106502	2778	Belt Guard with two SS706(819) ...
106503	2778	" " Bracket with three SS706(819) ...
SS707	2778	" " " Hinge Screw ...
SS706(819)	2778	" " " Screw ...
SS706(819)	2778	" " Screw ...
Tool 293	2778	" " " Key ...
106504	2778	" " Support ...
106505	2778	Belt Guard, complete, Nos. SS707 and 106502 to 106504 ...

## KNEE LIFTER

No.	Plate	Name
228713	18333	Rock Lever with two 350231(803) ...
228707	18333	" " Bracket with 200347(803) and three wood screws $\frac{3}{8}$ " No. 12 ...
228709	18333	" " " 228707 with 228363, 228367, 228386, 228455 and 228713 ...
228370	18333	" " Extension with 200530(803) ...
350231(803)	18333	" " " Set Screw ...
228363	18333	" " Hinge Pin ...

## ACCESSORIES

No.	Plate	Name
228364	18333	Rock Lever Knee Plate with 350231(803) ...
228388	18333	" " " " Arm ...
350231(803)	18333	" " " " " Set Screw ...
350231(803)	18333	" " " " " Set Screw ...
228455	18333	" " Position Spring ...
228365	18333	" " Rod ...
200530(803)	18333	" " " Set Screw ...
228386	18333	" " Spring ...
228367	18333	" " Stop Stud ...
200347(803)	18333	" " " " Set Screw ...
228710	18333	Knee Lifter Rock Lever, complete, Nos. 228364, 228365, 228370, 228388 and 228709 ...

(Other Knee Lifter parts are listed with parts of Machine Head).

## THREAD UNWINDER

No.	Plate	Name
228692	2895	Spool Pin ...
201528(808)	2895	" " Nut ...
82538	2895	" " Washer ...
225257	2895	" Rest (for two spools) with 201018(803), two each 82538, 201528(808) and 228692 ...
150203	2895	" " Cushion (felt) ...
225388	2895	" " Rod ...
200383(803)	2895	" " " Set Screw ...
201018(803)	2895	" " " Set Screw ...
259658	2895	" Stand with 200383(803) ...
225391	2895	Thread Guide ...
201696(808)	2895	" " Lock Nut ...
225326	2895	" " Position Cup ...
225324	2895	" " Rod with 208(830) and 225322 ...
208(830)	2895	" " " Screw ...
225322	2895	" " " Washer ...
225258	2895	Thread Unwinder (for two spools), complete, Nos. 201696(808), 225257, 225324, 225326, 225388, 259658, two each 150203, 225391 and three wood screws $\frac{3}{8}$ " No. 12 ...
27739	2895	Thread Cone (wood) (only supplied when specified on order and at an extra charge) ...

## Numerical List of Parts

No.	Plate	Name
176(819)	2842	Presser Foot Screw, for 272121 and 276241 ...
208(830)	2989	Feed Dog Screw ... ..
208(830)	2895	Thread Unwinder Thread Guide Rod Screw, for 225324 ... ..
223(809)	2837	Knife (upper) Screw ... ..
236(804)	—	Throat Plate Slide Screw for 276470 and 276488 ...
Tool 293	2778	Belt Guard Screw Key for SS706 ... ..
430(830)	—	Knife (upper) Holder Bracket Stud Binding Screw
453(850)	2841	Thread Take-up Spring Regulator Set Screw ...
578(804)	—	Throat Plate Cutting Bar Screw for 276470 and 276488 ... ..
591(806)	2839	Rotating Hook Bobbin Case Tension Spring Regu- lating Screw, for 52236 ... ..
592(805)	2839	Rotating Hook Bobbin Case Latch Stop Screw for 52237 ... ..
SS706(819)	2778	Belt Guard Bracket Screw for 106503 ... ..
SS706(819)	2778	Belt Guard Screw for 106502 ... ..
SS707	2778	Belt Guard Bracket Hinge Screw for 106595 ...
1053(805)	2839	Rotating Hook Thread Guard Screw, for 272137 ...
1253(830)	2839	Rotating Hook Set Screw, for 272136 ... ..
1367(805)	2839	Rotating Hook Section Screw, for 272138 ...
1380(805)	2839	Rotating Hook Bobbin Case Tension Spring Screw, for 52236 ... ..
1423(806)	2838	Bed Plate Screw ... ..
1454(806)	2989	Throat Plate Screw ... ..
1560(803)	2995	Tension Thumb Nut, for 52098 and 272222 ...
2102	2624	Bobbin Winder Tension Disc, for 225462 ... ..
2102	2841	Tension Disc, for 276049 ... ..
2291	2837	Knife (upper) Screw Washer ... ..
2974	2839	Rotating Hook Bobbin Case Latch Lever Fulcrum Pin, for 40393 ... ..
2975	2839	Rotating Hook Bobbin Case Latch Spring, for 52237
12361	2848	Machine Hinge Connection ... (Accessories)
13710	2624	Bobbin Winder Tension Spring, for 225462 ...
13710	2841	Tension Spring, for 276049 ... ..
24727	2989	Presser Foot Shank for 276474 and 276475 ...
26276	3009	Presser Foot Hinge Pin for 276474 and 276475 ...
27739	2895	Thread Unwinder Thread Cone (wood) ... ..
32572	2841	Tension Releasing Disc, for 276049 ... ..
39652	2841	Thread Take-up Spring, for 276049 ... ..
40392	2839	Rotating Hook Bobbin Case Latch, for 40393 ...
40393	2839	Rotating Hook Bobbin Case Hinge, Nos. 2974, 46392 and 125320, for 52237 ... ..

## NUMERICAL LIST OF PARTS

No.	Plate	Name
40394	2839	Rotating Hook Bobbin Case Tension Spring for 52236
41400	2848	Machine Rest Pin (wood) ... (Accessories)
50304(803)	2841	Tension Stud, for 52098 ...
50304(806)	2995	Tension Stud for 276225 ...
50305(803)	2995	Tension Stud Set Screw for 52083 ...
50438(804)	2989	Throat Plate Cutting Bar Screw, for 276468, 276469, 276486 and 276487 ...
50438(804)	2989	Throat Plate Slide Screw for 276468, 276469, 276486 and 276487 ...
52083	2841	Thread Take-up Spring Regulator with 50305(803), for 272222 and 276049 ...
52098	2841	Tension Stud 50304(803) with 1560(803) for 276049
52235	2839	Rotating Hook Bobbin Case, for 52236 ...
52236	2839	Rotating Hook Bobbin Case 52235 with 591(806), 1380(895) and 40394, for 52237 ...
52237	2839	Rotating Hook Bobbin Case, complete, Nos. 592(805), 2975, 40393 and 52236, for 270873 and 272139 ...
67425	3008	Rotary Take-up Guard Cover Hinge Screw Spring Washer ...
82538	2895	Thread Unwinder Spool Pin Washer for 225257 ...
85318	2848	Screw Driver ... (Accessories)
86659	3009	Presser Foot Plate for 86661 ...
86660	3009	Presser Foot Shank for 86661 ...
86661	3009	Presser Foot (hinged), complete, Nos. 86659 and 86660, for General Work ...
86698	—	Tin of Oil ( $\frac{1}{4}$ pint) ... (Accessories)
104211	2624	Bobbin Winder Pulley with 200380(803) for 104212
104212	2624	Bobbin Winder (swinging automatic, right hand), complete, Nos. 104211, 200056(805), 200082(804), 200113(806), 200299(808), 202478, 225381, 225444, 225453 to 225456, 225458, 225462, 228026, 259428 to 259430, two each 225459 and wood screws $\frac{1}{4}$ " No. 12 R.H.B. ...
106502	2778	Belt Guard with two SS706(819), for 106505 ...
106503	2778	Belt Guard Bracket with three SS706(819), for 106505 ...
106504	2778	Belt Guard Support for 106505 ...
106505	2778	Belt Guard, complete, Nos. SS707 and 106502 to 106504 ...
120342	2848	Oiler (copper plated) with 120343 (Accessories)
120343	2848	Oiler Spout (31" long) for 120342 (Accessories)
120378	2848	Screw Driver (bobbin case) ... (Accessories)
125320	2839	Rotating Hook Bobbin Case Latch Lever for 48393
127035	3009	Throat Plate Slide for 276486 ...
141566(803)	—	Machine Pulley Position Screw for 276444 ...
141567(803)	—	Machine Pulley Set Screw for 276444 ...
141568(819)	3008	Face Plate Tension Guard Screw for 276443 ...

## NUMERICAL LIST OF PARTS

No.	Plate	Name
141569(819)	3008	Rotary Take-up Guard Screw (long) for 451K11 Machine ...
141570(819)	3008	Rotary Take-up Guard Screw (short) for 451K11 Machine ...
143301	2839	Rotating Hook Oil Wick (felt) for 272136 ...
147211	2837	Knife (upper) for 451K11 Machine ...
147262	2989	Throat Plate Cutting Bar for 276468 and 276486 ...
147267	—	Throat Plate Slide for 276470 and 276488 ...
147269	—	Throat Plate Cutting Bar for 276470 and 276488 ...
147272	—	Throat Plate Slide for 276469 and 276487 ...
147274	—	Throat Plate Cutting Bar for 276469 and 276487 ...
149025	3009	Feed Dog, 9 teeth (12 teeth to the inch) for 451K111 Machine ...
149126	2989	Feed Dog, 12 teeth (16 teeth to the inch) for 451K111 Machine ...
150203	2895	Thread Unwinder Spool Rest Cushion (felt) for 225258 ...
200004(805)	2845	Arm Screw ...
200031(819)	2841	Rotary Take-up Guard Screw (long) for 451K111 Machine ...
200040(805)	2840	Feed Bar Lifting Crank Pinch Screw, for 272109 ...
200040(805)	2840	Feed Driving Connection Crank Pinch Screw, for 276230 ...
200040(805)	2840	Feed Reversing Shaft Crank Pinch Screw, for 276163
200041(819)	2845	Rotating Hook Oil Reservoir Cover Screw ...
200053(819)	2845	Arm Cover (back) Screw ...
200054(805)	2842	Needle Bar Connecting Link Guide Block Screw ...
200056(805)	2624	Bobbin Winder Stop Latch Screw, for 104212
200069(819)	2841	Rotary Take-up Guard Screw (short) for 451K111 Machine ...
200070(803)	2844	Rotating Hook Driving Shaft Connection Belt Pulley Set Screw, for 270169 ...
200077(804)	2839	Rotating Hook Bobbin Case Holder Position Bracket Screw ...
200077(805)	2837	Knife (upper) Holder Screw ...
200082(804)	2624	Bobbin Winder Tension Bracket Screw, for 104212
200092(806)	2840	Feed Reversing Shaft Spring Adjusting Collar Set Screw for 276167 and 276457 ...
200113(806)	2624	Bobbin Winder Brake Clamp Screw, for 104212
200113(806)	2845	Knee Lifter Lifting Rod Spring Collar Set Screw, for 227227 ...
200130(806)	2837	Knife (upper) Holder Bracket Latch Screw ...
200132(805)	2842	Tension Releaser Screw ...
200136(804)	2837	Knife (upper) Driving Link Hinge Pin Set Screw for 270627 ...
200145(830)	2842	Thread Pull-off Screw ...
200161(819)	2841	Rotary Take-up Guard Cover Grill Screw ...

## NUMERICAL LIST OF PARTS

No.	Plate	Name
200169(803)	—	Feed Bar Lifting Link Cap Screw ... ..
200190(804)	2837	Knife (upper) Driving Connection Crank Pinch Screw for 276458 ... ..
200263(850)	3008	Rotary Take-up Guard Cover Hinge Screw ... ..
200272(803)	2845	Knee Lifter Rock Frame Hinge Screw (front) ... ..
200293(830)	2842	Knee Lifter Lifting Link Hinge Screw ... ..
200299(808)	2624	Bobbin Winder Stop Latch Trip Lever Hinge Screw, for 104212 ... ..
200333(803)	2844	Feed Driving Flange Position Screw, for 276180 ... ..
200333(803)	2846	Needle Bar Crank Position Screw, for 276492 and 276493 ... ..
200346(803)	2844	Feed Driving Flange Set Screw, for 276180 ... ..
200346(803)	2840	Feed Reversing Mechanism Support Stud Set Screw
200346(803)	2846	Knife (upper) Driving Eccentric Set Screw for 270625 and 276480 ... ..
200346(803)	2844	Rotating Hook Driving Shaft Bushing Set Screw
200346(803)	2844	Rotating Hook Shaft Bushing Set Screw ... ..
200347(830)	2837	Knife (upper) Driving Connection Crank Hinge Stud Set Screw ... ..
200347(803)	18333	Knee Lifter Rock Lever Stop Stud Set Screw, for 228707 ... ..
200363(830)	2846	Arm Shaft Connection Belt Pulley Set Screw, for 271127 ... ..
200366(819)	2841	Thread Retainer (rear) Set Screw for 451K111 Machine ... ..
200374(830)	2846	Needle Bar Connecting Link Hinge Stud Set Screw, for 276023 and 276115 ... ..
200378(803)	2846	Needle Bar Crank Position Screw Check Screw, for 276492 and 276493 ... ..
200380(803)	2624	Bobbin Winder Pulley Set Screw, for 104211 ... ..
200380(803)	2837	Knife (upper) Driving Connection Crank Hinge Stud Collar Set Screw for 202574 ... ..
200380(803)	2837	Knife (upper) Holder Adjusting Screw ... ..
200382(833)	2844	Feed Lifting Eccentric Set Screw, for 276231 ... ..
200382(833)	2840	Feed Reversing Shaft Bushing Set Screw ... ..
200382(833)	2844	Rotating Hook Driving Shaft Gear Set Screw, for 276047 ... ..
200383(803)	2895	Thread Unwinder Spool Rest Rod Set Screw, for 259658 ... ..
200386(803)	2840	Feed Reversing Shaft Crank Hinge Stud Set Screw, for 276163 ... ..
200394(803)	2840	Feed Bar Hinge Pin Set Screw, for 272116 ... ..
200394(803)	2840	Feed Driving Connection Link Hinge Pin Set Screw, for 276165 ... ..
200397(819)	2995	Pre-Tension Stud Collar Set Screw for 272207 ... ..
200397(819)	2841	Thread Retainer (front) Set Screw for 451K111 Machine ... ..

## NUMERICAL LIST OF PARTS

No.	Plate	Name
200530(803)	18333	Knee Lifter Rock Lever Rod Set Screw, for 228370
200545(803)	2840	Feed Lifting Connection Hinge Screw ... ..
200567(819)	2841	Rotary Take-up Clamping Plate Screw for 451K111 Machine ... ..
200575(819)	2840	Feed Reversing Lever Handle Screw ... ..
200577(830)	3008	Rotary Take-up Screw ... ..
200583(819)	2841	Thread Cutter Screw for 451K111 Machine ... ..
200583(819)	—	Thread Cutter (on Face Plate) Screw for 451K111 Machine ... ..
200586(819)	2841	Face Plate Thread Guard Screw, for 276240 ... ..
200679(806)	2845	Knee Lifter Rock Frame Hinge Screw (back) ... ..
200685(803)	2841	Rotary Take-up Guard Thread Guide Screw for 451K111 Machine ... ..
200904(819)	3008	Thread Cutter (on Rotary Take-up Guard) Screw for 451K111 Machine ... ..
201018(803)	2895	Thread Unwinder Spool Rest Set Screw, for 225257
201018(819)	2837	Knife (upper) Driving Connection Crank Oil Guard Thumb Screw ... ..
201107(803)	2840	Feed Reversing Lever Connection Hinge Screw (lower) ... ..
201185(804)	—	Knife (upper) Driving Link (lower half) Retaining Screw ... ..
201215(804)	2844	Rotating Hook Shaft End Bearing Screw, for 272220 and 276060 ... ..
201220(803)	2844	Feed Driving Eccentric Adjusting Disc Spring Collar Set Screw, for 270111 and 276009 ... ..
201220(803)	2844	Feed Lifting Eccentric Position Screw, for 276231 ... ..
201220(803)	2844	Rotating Hook Driving Shaft Gear Position Screw, for 276047 ... ..
201254(803)	2840	Feed Driving Rock Shaft Centre Set Screw ... ..
201254(803)	2840	Feed Lifting Rock Shaft Centre Set Screw ... ..
201320(804)	2837	Knife (upper) Holder Bracket Adjusting Screw for 276461 ... ..
201499(808)	2624	Bobbin Winder Tension Stud, for 225461 ... ..
201520(819)	2840	Feed Reversing Lever Connection Hinge Screw (upper) Nut ... ..
201522(805)	2840	Feed Lifting Connection Hinge Screw Nut ... ..
201524(819)	2840	Feed Reversing Lever Stop Pin Nut ... ..
201528(808)	2895	Thread Unwinder Spool Pin Nut, for 225257 ... ..
201529(819)	2840	Feed Reversing Lever Handle Screw Nut ... ..
201531(805)	2840	Feed Driving Connection Crank Hinge Screw Nut ... ..
201537(805)	3008	Rotary Take-up Guard Cover Spring Catch Screw Nut
201537(819)	2837	Knife (upper) Holder Bracket Adjusting Screw Nut for 276461 ... ..
201572(808)	2624	Bobbin Winder Tension Stud Thumb Nut, for 225462
201696(808)	2895	Thread Unwinder Thread Guide Lock Nut, for 225258 ... ..

## NUMERICAL LIST OF PARTS

No.	Plate	Name
202005	2845	Arm Screw Washer ... ..
202079	2995	Tension Wheel Washer (felt) for 272222 ... ..
202101	2837	Knife (upper) Holder Screw Washer ... ..
202277	2842	Needle Bar Connecting Stud Oil Packing Wick for 270057 and 270856 ... ..
202302	2845	Knee Lifter Lifting Rod Cotter Pin, for 276015 ... ..
202423	2844	Rotating Hook Shaft Oil Filter Wick, for 276062 ... ..
202478	2624	Bobbin Winder Stop Latch Trip Lever, for 104212 ... ..
202574	2837	Knife (upper) Driving Connection Crank Hinge Stud Collar with 200380(803) ... ..
203213	2837	Knife (upper) Driving Link (upper half) Locking Plunger Spring ... ..
204235	2845	Arm Position Pin ... ..
210958	2995	Pre-Tension Stud Collar for 272210 ... ..
210993	2995	Pre-Tension Sleeve for 272210 ... ..
214206	2846	Arm Shaft Connection Belt Pulley Spring Flange, for 271127 ... ..
214206	2844	Rotating Hook Driving Shaft Connection Belt Pulley Spring Flange, for 270169 ... ..
225257	2895	Thread Unwinder Spool Rest (for two spools) with 201018(803), two each 82538, 201528(808) and 228692, for 225258 ... ..
225258	2895	Thread Unwinder (for two spools) complete, Nos. 201696(808), 225257, 225324, 225326, 225388, 259658, two each 159203, 225391 and three wood screws $\frac{3}{8}$ ", No. 12 ... ..
225322	2895	Thread Unwinder Thread Guide Rod Washer, for 225324 ... ..
225324	2895	Thread Unwinder Thread Guide Rod with 208(830), and 225322, for 225258 ... ..
225326	2895	Thread Unwinder Thread Guide Position Cup, for 225258 ... ..
225381	2624	Bobbin Winder Spindle, for 104212 ... ..
225388	2895	Thread Unwinder Spool Rest Rod, for 225258 ... ..
225391	2895	Thread Unwinder Thread Guide, for 225258 ... ..
225444	2624	Bobbin Winder Stop Latch, for 104212 ... ..
225453	2624	Bobbin Winder Frame with 244071 and 259660, for 104212 ... ..
225454	2624	Bobbin Winder Frame Hinge Pin, for 104212 ... ..
225455	2624	Bobbin Winder Frame Spring, for 104212 ... ..
225456	2624	Bobbin Winder Frame Spring Plunger for 104212 ... ..
225458	2624	Bobbin Winder Stop Latch Thumb Lever, for 104212 ... ..
225459	2624	Bobbin Winder Stop Latch Thumb Lever Hinge Stud, for 104212 ... ..
225459	2624	Bobbin Winder Stop Latch Thumb Lever Joint Stud, for 104212 ... ..

## NUMERICAL LIST OF PARTS

No.	Plate	Name
225461	2624	Bobbin Winder Tension Bracket with 201499(808) for 225462 ... ..
225462	2624	Bobbin Winder Tension Bracket, complete, Nos. 13710, 201572(808), 225461 and two 2102, for 104212 ... ..
227227	2845	Knee Lifter Lifting Rod Spring Collar with 200113(806) ... ..
228026	2624	Bobbin Winder Tension Bracket Screw Washer, for 104212 ... ..
228363	18333	Knee Lifter Rock Lever Hinge Pin, for 228709 ... ..
228364	18333	Knee Lifter Rock Lever Knee Plate with 350231(803) for 228710 ... ..
228365	18333	Knee Lifter Rock Lever Rod, for 228710 ... ..
228367	18333	Knee Lifter Rock Lever Stop Stud, for 228709 ... ..
228370	18333	Knee Lifter Rock Lever Extension with 200530(803) for 228710 ... ..
228386	18333	Knee Lifter Rock Lever Spring, for 228709 ... ..
228388	18333	Knee Lifter Rock Lever Knee Plate Arm, for 228710 ... ..
228455	18333	Knee Lifter Rock Lever Position Spring, for 228709 ... ..
228478	18311	Drip Pan with four $\frac{3}{4}$ " wire nails for 451K11 Machine ... ..
228479	18333	Drip Pan with four $\frac{3}{4}$ " wire nails for 451K111 Machine ... ..
228692	2895	Thread Unwinder Spool Pin, for 225257 ... ..
228707	18333	Knee Lifter Rock Lever Bracket with 200347(803) and three wood screws $\frac{3}{8}$ " No. 12, for 228709 ... ..
228709	18333	Knee Lifter Rock Lever Bracket 228707 with 228363, 228367, 228386, 228455 and 228713, for 228710 ... ..
228710	18333	Knee Lifter Rock Lever, complete, Nos. 228364, 228365, 228370, 228388 and 228709 ... ..
228713	18333	Knee Lifter Rock Lever with two 350231(803), for 228709 ... ..
230743(803)	3008	Rotary Take-up Guard Cover Hinge Screw Thrust Washer ... ..
240231	2844	Feed Driving Eccentric Friction Gib ... ..
240245	2844	Feed Regulating Stud Retaining Spring ... ..
240566	—	Wrench ... .. (Accessories)
244071	2624	Bobbin Winder Frame Oil Packing (wick) for 225453 ... ..
244071	2840	Feed Driving Connection Link Hinge Pin Oil Packing (wick) for 276171 ... ..
259428	2624	Bobbin Winder Brake (leather) for 104212 ... ..
259429	2624	Bobbin Winder Brake Clamp, for 104212 ... ..
259430	2624	Bobbin Winder and Tension Bracket Base, for 104212 ... ..
259658	2895	Thread Unwinder Spool Stand with 200383(803), for 225258 ... ..
259660	2624	Bobbin Winder Frame Oil Well Washer, for 225453 ... ..
268063	2837	Knife (upper) Driving Connection Needle Bearing (upper) for 270621 ... ..

## NUMERICAL LIST OF PARTS

No.	Plate	Name
268258	2837	Knife (upper) Holder Bracket Stud Oil Packing (wick) for 276462 and 276481
270009	2845	Bed Slide
270010	2839	Rotating Hook Bobbin
270013	2840	Feed Lifting Connection, for 270014
270014	2840	Feed Lifting Connection 270013 with 270016
270016	2840	Feed Driving Connection Needle Bearing, for 276154
270016	2840	Feed Lifting Connection Needle Bearing, for 270014
270017	2844	Feed Driving Eccentric
270026	2844	Feed Regulating Stud Spring
270036	2844	Rotating Hook Driving Shaft Oil Lead Wire
270044	2844	Rotating Hook Shaft Thrust Washer, for 272229 and 276060
270055	2842	Needle Bar Connecting Link Guide Block for 451K11 Machine
270057	2842	Needle Bar Connecting Stud with 202277 and 350622(833) for 451K11 Machine
270058	2842	Needle Bar Oiling Felt
270080	2841	Thread Retainer (rear) for 451K111 Machine
270086	2995	Tension Releasing Pin, for 272222 and 276049
270111	2844	Feed Driving Eccentric Adjusting Disc Spring Collar with 201220(803) for 451K111 Machine
270124	2842	Needle Bar Bushing (lower) for 451K11 Machine
270137	2844	Feed Driving Eccentric Adjusting Disc Spring
270140	2844	Feed Regulating Stud
270155	2844	Rotating Hook Oil Reservoir Oil Gauge
270161	3008	Rotary Take-up Mounting Disc Position Pin for 272206
270163	2844	Rotating Hook Shaft Bushing, for 276060
270164	2844	Rotating Hook Shaft End Bearing, for 272229 and 276060
270169	2844	Rotating Hook Driving Shaft Connection Belt Pulley with 214206 and two 200070(803)
270256	2843	Knee Lifter Lifting Link for 451K111 Machine
270261	2842	Needle Bar Bushing (upper) for 451K111 Machine
*270262	2843	Needle Bar Connecting Link for 270263
270263	2843	Needle Bar Connecting Link 270262 with 270266 for 451K111 Machine
270264	2843	Needle Bar Connecting Link Guide Block for 451K111 Machine
270266	2842	Needle Bar Connecting Link Needle Bearing for 270263 and 276019
270305	2842	Needle Bar Connecting Link Thrust Washer for 451K11 Machine
270620	2837	Knife (upper) Driving Connection for 270621
270621	2837	Knife (upper) Driving Connection 270620 with 268063 and 270653

## NUMERICAL LIST OF PARTS

No.	Plate	Name
270623	2837	Knife (upper) Driving Connection Crank Hinge Stud
270625	2846	Knife (upper) Driving Eccentric with two 200346(803) for 451K11 Machine
270626	2846	Knife (upper) Driving Eccentric Cap Washer
270627	2837	Knife (upper) Driving Link (lower half) with 200136(804)
270629	2837	Knife (upper) Driving Link (upper half)
270630	2837	Knife (upper) Driving Link (upper half) Hinge Stud
270631	2837	Knife (upper) Driving Link (upper half) Locking Plunger
270632	2837	Knife (upper) Driving Link Hinge Pin
270637	2837	Knife (upper) Holder Bracket Latch
270653	2840	Feed Driving Connection Link Needle Bearing, for 276170
270653	2837	Knife (upper) Driving Connection Needle Bearing (lower) for 270621
270656	2842	Needle Bar with 350621(830) for 451K11 Machine
270855	2843	Needle Bar Bushing (upper) for 451K111 Machine
270856	2843	Needle Bar Connecting Stud with 202277 and 350622(830) for 451K111 Machine
270872	2830	Rotating Hook Bobbin Case Holder (chromium plated) for 270873 and 272138
270873	2830	Rotating Hook Bobbin Case 52237 with 270872 (for agents only)
270874(806)	2830	Rotating Hook Thread Guard, for 272137
270878	2830	Rotating Hook Oil Retaining Washer (felt) for 272136
270879	2830	Rotating Hook Oil Guard
270880	2844	Rotating Hook Shaft Bushing Oil Packing (wick) for 272229 and 276060
270926	2846	Arm Shaft Connection Belt (reinforced neoprene)
270941	2840	Feed Driving Rock Shaft Centre
270941	2840	Feed Lifting Rock Shaft Centre
270942	2840	Feed Driving Rock Shaft Insert (nylon) for 272116
271127	2840	Feed Lifting Rock Shaft Insert (nylon), for 272118
272106	2846	Arm Shaft Connection Belt Pulley with 200363(830), 350492(803) and two 214206
272107	2840	Feed Bar
272108	2840	Feed Bar Hinge Pin
272109	2840	Feed Bar Hinge Pin Thrust Washer
272110	2840	Feed Bar Lifting Crank with 200040(805)
272111	2840	Feed Bar Lifting Link
272112	2840	Feed Bar Lifting Link Oiling Wick Clamp
272115	2840	Feed Bar Hinge Pin Lubricating Felt
272116	2840	Feed Bar Lifting Link Oiling Wick
	2840	Feed Driving Rock Shaft with two each 200394(803) and 270942



## NUMERICAL LIST OF PARTS

No.	Plate	Name
272118	2840	Feed Lifting Rock Shaft with two 270942 ...
272121	2842	Presser Bar with 176(819) for 451K11 Machine ...
272122	2842	Presser Bar Position Guide with 350411(803) ...
272123	2845	Presser Bar Spring for 451K11 Machine ...
272131	2839	Rotating Hook Bobbin Case Holder Position Bracket ...
272132	2839	Rotating Hook Section for 272138 ...
272136	2839	Rotating Hook with 143301, 270878 and two 1253(830), for 272137 ...
272137	2839	Rotating Hook 272136 with 270874(806) and four 1053(805), for 272138 ...
272138	2839	Rotating Hook 272137 with 270872, 272132 and three 1367(805) for 272139 ...
272139	2839	Rotating Hook 272138 with 52237 ...
272142	2847	Arm Shaft Ball Bearing (back) for 276176 and 276445
272143	2846	Arm Shaft Ball Bearing (front) for 276492 and 276493
272144	2844	Rotating Hook Driving Shaft Ball Bearing ...
272145	2846	Needle Bar Connecting Link Hinge Stud Oiling Felt Flange for 276492 and 276493 ...
272154	—	Rotating Hook Oil Reservoir Cover Washer (fibre)
272206	2842	Needle Bar Connecting Link Hinge Stud with 270161 for 451K11 Machine ...
272207	2995	Pre-Tension Bracket with 200397(819) for 272210 ...
272208	2995	Pre-Tension Spring for 272210 ...
272209	2995	Pre-Tension Stud for 272210 ...
272210	2995	Pre-Tension Bracket, complete, Nos. 210958, 210993 and 272207 to 272209 for 451K11 Machine ...
272211	3008	Rotary Take-up for 451K11 Machine ...
272212	3008	Rotary Take-up Counterbalance Rivet for 272217 ...
272216	3008	Rotary Take-up Guard Thread Shield for 451K11 Machine ...
272217	3008	Rotary Take-up Mounting Disc with three 272212 for 451K11 Machine ...
272218	2995	Tension Releasing Disc for 272222 ...
272219	2995	Tension Spring for 272222 ...
272220	2995	Tension Washer for 276225 ...
272221	2995	Tension Wheel for 272222 ...
272222	2995	Tension (rotary) complete, Nos. 1560(803), 52083, 270086, 272218, 272219, 272221, 272225, 276225 and two 202079 for 451K11 Machine ...
272223	3008	Thread Cutter (on Face Plate) for 451K11 Machine
272224	3008	Thread Cutter (on Rotary Take-up Guard) for 451K11 Machine ...
272225	2995	Thread Take-up Spring for 272222 ...
272228	2844	Rotating Hook Shaft Bushing for 272229 ...

## NUMERICAL LIST OF PARTS

No.	Plate	Name
272229	2844	Rotating Hook Shaft Bushing, complete, Nos. 270044, 270164, 270880, 272228, 276059, 276062, 350498(805) and two 201215(804) for 451K11 Machine ...

## NUMERICAL LIST OF PARTS

No.	Plate	Name
276002	2845	Arm Cover (back) ... ..
276009	2844	Feed Driving Eccentric Adjusting Disc Spring Collar with 201220(803) for 451K11 Machine ... ..
276014	2842	Knee Lifter Lifting Link for 451K11 Machine ... ..
276015	2845	Knee Lifter Lifting Rod with 202302 ... ..
276016	2845	Knee Lifter Lifting Rod Spring ... ..
276017	2845	Knee Lifter Rock Frame for 451K11 Machine ... ..
*276018	2842	Needle Bar Connecting Link, for 276019 ... ..
276019	2842	Needle Bar Connecting Link 276018 with 270266 for 451K11 Machine ... ..
276021	2846	Needle Bar Connecting Link Hinge Stud Oiling Felt for 276492 ... ..
*276023	2846	Needle Bar Crank with two 200374(830) for 276492
276025	2842	Presser Bar Ball, $\frac{3}{8}$ " diameter ... ..
276027	2842	Presser Bar Lifter for 451K11 Machine ... ..
276028	2842	Presser Bar Lifting Releasing Lever Bracket ... ..
276034	2841	Rotary Take-up Clamping Plate for 451K111 Machine ... ..
276038	3008	Rotary Take-up Guard Cover Grill ... ..
276043	2841	Rotary Take-up Spacer for 451K111 Machine ... ..
276044	2844	Rotating Hook Driving Shaft for 451K11 Machine
276045	2844	Rotating Hook Driving Shaft Bushing with 276046
276046	2840	Feed Reversing Shaft Crank Hinge Stud Oil Packing (wick) for 276164 ... ..
276046	2844	Rotating Hook Driving Shaft Bushing Oil Packing (wick) for 276045 ... ..
276047	2844	Rotating Hook Driving Shaft Gear (internal teeth) with 200382(833) and 201220(803) ... ..
276048	2842	Tension Releaser (adjustable) ... ..
276049	2841	Tension, complete, Nos. 13710, 32572, 39652, 52083, 52098, 270086 and two 2102 for 451K111 Machine
276050	2841	Thread Cutter for 451K111 Machine ... ..
276051	3008	Thread Guide ... ..
276052	2841	Thread Retainer (front) for 451K111 Machine ... ..
276053	2846	Needle Bar Connecting Link Hinge Stud Oiling Felt Oil Leader Tube ... ..
276054	2841	Face Plate Thread Guard, for 276240 ... ..
276055	2841	Tension Thread Guide Pin for 451K111 Machine ... ..
276057	2842	Thread Pull-off for 451K11 Machine ... ..
276059	2844	Rotating Hook Shaft for 272229 and 276060 ... ..
276060	2844	Rotating Hook Shaft Bushing, complete, Nos. 270044, 270163, 270164, 270889, 276059, 276062, 350498(805) and two 201215(804), for 451K111 Machine ... ..
276061	2844	Rotating Hook Shaft Oil Filter Wick Holder, for 276062 ... ..

## NUMERICAL LIST OF PARTS

No.	Plate	Name
276062	2844	Rotating Hook Shaft Oil Filter, complete, Nos. 202423 and 276061 for 272229 and 276060 ... ..
276109	2845	Knee Lifter Rock Frame for 451K111 Machine ... ..
276111	2843	Needle Bar Bushing (lower) for 451K111 Machine
276112	2843	Needle Bar Connecting Link Hinge Stud for 451K111 Machine ... ..
276113	2847	Needle Bar Connecting Link Hinge Stud Oiling Felt for 276493 ... ..
276114	2843	Needle Bar Connecting Link Thrust Washer for 451K111 Machine ... ..
*276115	2847	Needle Bar Crank with two 200374(830) for 276493
276117	2843	Presser Bar Lifter for 451K111 Machine ... ..
276118	—	Thread Pull-off for 451K111 Machine ... ..
276120	2841	Rotary Take-up for 451K111 Machine ... ..
276121	2841	Rotary Take-up Adjusting Disc for 276122 ... ..
276122	—	Rotary Take-up Adjusting Disc 276121 with 276123 and two 350503(833) for 451K111 Machine ... ..
276123	2841	Rotary Take-up Counterbalance for 276122 ... ..
276125	2844	Rotating Hook Driving Shaft for 451K111 Machine
*276152	—	Bed for 451K111 Machine ... ..
276153	2840	Feed Driving Connection, for 276154 ... ..
276154	2840	Feed Driving Connection 276153 with 270016 (for agents only)
276155	2844	Feed Driving Eccentric Adjusting Disc for 451K111 Machine ... ..
276157	2840	Feed Reversing Lever with 350477(803) ... ..
276158	2840	Feed Reversing Lever Connection ... ..
276159	2840	Feed Reversing Lever Hinge Pin ... ..
276160	2840	Feed Reversing Lever Handle ... ..
276162	2840	Feed Reversing Shaft Bushing (back) ... ..
276163	2840	Feed Reversing Shaft Crank with 200040(805) and 200386(803) ... ..
276164	2840	Feed Reversing Shaft Crank Hinge Stud with 276046
276165	2840	Feed Reversing Shaft Crank Link with 200394(803)
276166	2840	Feed Reversing Shaft Spring for 451K111 Machine
276167	2840	Feed Reversing Shaft Spring Adjusting Collar with two 200092(806) for 451K111 Machine... ..
276169	2840	Feed Driving Connection Link, for 276170 ... ..
276170	2840	Feed Driving Connection Link 276169 with 270653 (for agents only)
276171	2840	Feed Driving Connection Link Hinge Pin with 244071
276175	2847	Machine Pulley (aluminium alloy casting) for "V" belt (outside diam. of belt groove 2.9 in., rim diam. $4\frac{1}{2}$ in.) with 350540(803) and 350541(803) for 276176 ... ..
276176	2847	Machine Pulley 276175 with 272142 for 451K111 Machine ... ..

## NUMERICAL LIST OF PARTS

No.	Plate	Name
276177	2845	Rotating Hook Oil Reservoir Cover ... ..
276179	2840	Feed Reversing Shaft Bushing (front), ... ..
276180	2844	Feed Driving Flange with 200333(803), 200346(803), two each 350562(850) and 350578(850) ... ..
276181	2840	Feed Reversing Mechanism Support Link ... ..
276182	2840	Feed Reversing Mechanism Support Stud ... ..
*276187	—	Bed for 451K11 Machine ... ..
276188	2844	Feed Driving Eccentric Adjusting Disc for 451K11 Machine ... ..
276225	2995	Tension Stud 50304(806) with 272220 for 272222 ... ..
276228	2841	Rotary Take-up Guard Cover for 451K111 Machine ... ..
276229	2841	Rotary Take-up Guard Cover Spring Catch for 451K111 Machine ... ..
276230	2840	Feed Driving Connection Crank with 200040(805) ... ..
276231	2844	Feed Lifting Eccentric with 200382(833) and 201220(803) ... ..
276240	2841	Face Plate with 276054 and four 200586(819) for 451K111 Machine ... ..
276241	2843	Presser Bar with 176(819) for 451K111 Machine ... ..
276242	2845	Presser Bar Spring for 451K111 Machine ... ..
*276441	—	Arm for 451K11 Machine ... ..
276442	3008	Face Plate for 276443 ... ..
276443	3008	Face Plate 276442 with 276503 and two 141568(819) for 451K11 Machine ... ..
276444	—	Machine Pulley (aluminium alloy casting) for "V" belt (outside diam. of belt groove 2.9", rim diam. 4") with 141566(803) and 141567(803) for 276445
276445	—	Machine Pulley 276444 with 272142 for 451K11 Machine ... ..
276446	2842	Presser Bar Bushing for 451K11 Machine ... ..
276447	3008	Tension (rotary) Threading Guide for 451K11 Machine ... ..
*276452	2846	Arm Shaft for 276492 ... ..
276454	2838	Bed Plate ... ..
276456	—	Feed Reversing Shaft Spring for 451K11 Machine ... ..
276457	—	Feed Reversing Shaft Spring Adjusting Collar with two 200092(806) for 451K11 Machine ... ..
276458	2837	Knife (upper) Driving Connection Crank with 200190(804) ... ..
276459	2837	Knife (upper) Driving Connection Crank Oil Guard
276460	2837	Knife (upper) Holder ... ..
276461	2837	Knife (upper) Holder Bracket with 201320(804) and 201537(819) ... ..
276462	—	Knife (upper) Holder Bracket Stud with 268258 for 451K11 Machine ... ..
276464	2842	Thread Guide (on Needle Bar Bushing) ... ..
276465	—	Feed Reversing Shaft for 451K11 Machine ... ..

## NUMERICAL LIST OF PARTS

No.	Plate	Name
276466	2989	Throat Plate Body for 276468 to 276470 ... ..
276467	2989	Throat Plate Slide for 276468 ... ..
276468	2989	Throat Plate, complete, 46 needle hole, in trimming margin from $\frac{1}{8}$ " to $\frac{1}{4}$ ", in steps of $\frac{1}{32}$ ", Nos. 147262, 276466, 276467 and three 50438(804) for 149126 for 451K11 Machine ... ..
276469	—	Throat Plate, complete, 46 needle hole, in $\frac{3}{32}$ " trimming margin, Nos. 147272, 147274, 276466 and three 50438(804) for 149126 for 451K11 Machine ... ..
276470	—	Throat Plate, complete, 46 needle hole, in $\frac{1}{16}$ " trimming margin, Nos. 236(804), 147267, 147269, 276466 and two 578(804) for 149126, for 451K11 Machine ... ..
276471	2841	Rotary Take-up Guard for 451K111 Machine ... ..
276472	3009	Presser Foot Plate for 276474 ... ..
276473	2989	Presser Foot Plate for 276475 ... ..
276474	3009	Presser Foot (hinged) complete, 46 needle hole, in trimming margins from $\frac{1}{16}$ " to $\frac{1}{8}$ ", in steps of $\frac{1}{32}$ ". Nos. 24727, 26276 and 276472... ..
276475	2989	Presser Foot (hinged) complete, 46 needle hole, in $\frac{1}{8}$ " and $\frac{1}{16}$ " trimming margins, Nos. 24727, 26276 and 276473... ..
*276476	—	Arm for 451K111 Machine ... ..
*276477	2847	Arm Shaft for 276493 ... ..
276479	2840	Feed Reversing Shaft for 451K111 Machine ... ..
276480	2847	Knife (upper) Driving Eccentric with two 200346(803) for 451K111 Machine ... ..
276481	2837	Knife (upper) Holder Bracket Stud with 268258 for 451K111 Machine ... ..
276482	2843	Needle Bar with 350621(830) for 451K111 Machine ... ..
276483	2843	Presser Bar Bushing for 451K111 Machine ... ..
276485	3009	Throat Plate Body for 276486 to 276488 ... ..
276486	3009	Throat Plate, complete, 46 needle hole, in trimming margins from $\frac{1}{8}$ " to $\frac{1}{4}$ ", in steps of $\frac{1}{32}$ ", Nos. 127035, 147262, 276485 and three 50438(804) for 149025 for 451K111 Machine ... ..
276487	—	Throat Plate, complete, 46 needle hole, in $\frac{3}{32}$ " trim- ming margin, Nos. 147272, 147274, 276485 and three 50438(804) for 149025 for 451K111 Machine
276488	—	Throat Plate, complete, 46 needle hole, in $\frac{1}{16}$ " trimming margin, Nos. 236(804), 147267, 147269, 276485 and two 578(804) for 149025 for 451K111 Machine ... ..
276489	—	Knife (upper) for 451K111 Machine ... ..
276491	2845	Rotating Hook Oil Reservoir Cover Gasket ... ..

## NUMERICAL LIST OF PARTS

No.	Plate	Name
276492	2846	Arm Shaft 276452 with 200333(803), 200378(803), 272143, 272145, 276021 and 276023 for 451K11 Machine ... ..
276493	2847	Arm Shaft 276477 with 200333(803), 200378(803), 272143, 272145, 276113 and 276115 for 451K11 Machine ... ..
276503	3008	Face Plate Tension Guard for 276443 ... ..
276506	3008	Rotary Take-up Guard for 451K11 Machine ... ..
276507	3008	Rotary Take-up Guard Cover for 451K11 Machine ... ..
276508	3008	Rotary Take-up Guard Cover Spring Catch for 451K11 Machine ... ..

## NUMERICAL LIST OF PARTS

No.	Plate	Name
350231(803)	18333	Knee Lifter Rock Lever Extension Set Screw for 228713 ... ..
350231(803)	18333	Knee Lifter Rock Lever Knee Plate Arm Set Screw, for 228713 ... ..
350231(803)	18333	Knee Lifter Rock Lever Knee Plate Set Screw, for 228364 ... ..
350411(803)	2842	Presser Bar Position Guide Pinch Screw, for 272122
350435(803)	2845	Presser Bar Spring Screw (pressure regulating) ... ..
350442(803)	2842	Presser Bar Lifter Hinge Screw ... ..
350477(803)	2840	Feed Reversing Lever Hinge Pin Set Screw, for 276157 ... ..
350492(803)	2846	Arm Shaft Connection Belt Pulley Position Screw, for 271127 ... ..
350498(805)	2844	Rotating Hook Shaft Oil Regulating Screw, for 272229 and 276060 ... ..
350499(850)	2845	Presser Bar Spring Screw Stud ... ..
350503(833)	3008	Face Plate Screw ... ..
350503(833)	2841	Rotary Take-up Counterbalance Screw for 276122 ... ..
350503(819)	3008	Tension (rotary) Threading Guide Screw for 451K11 Machine ... ..
350503(833)	3008	Thread Guide Screw ... ..
350503(819)	3008	Rotary Take-up Guard Cover Spring Catch Screw ... ..
350507(803)	2840	Feed Driving Connection Crank Hinge Screw ... ..
350509(803)	2840	Feed Reversing Lever Connection Hinge Screw (upper) ... ..
350540(803)	2847	Machine Pulley Position Screw for 276175 ... ..
350541(803)	2847	Machine Pulley Set Screw, for 276175 ... ..
350550(830)	2842	Needle Bar Bushing (upper) Set Screw ... ..
350552(819)	2995	Pre-Tension Bracket Screw for 451K11 Machine ... ..
350562(850)	2844	Feed Driving Eccentric Friction Gib Adjusting Screw Set Screw, for 276180 ... ..
350569(803)	2840	Feed Reversing Lever Stop Pin ... ..
350578(850)	2844	Feed Driving Eccentric Friction Gib Adjusting Screw, for 276180 ... ..
350621(830)	2842	Needle Set Screw for 270656 and 276482 ... ..
350622(833)	2842	Needle Bar Connecting Stud Pinch Screw for 270057 and 270856 ... ..