

Form 8491  
June, 1918

# PRICE LIST

OF

# PARTS



# MACHINES

Nos. 53-1 to 53-4

---

THE SINGER MANUFACTURING COMPANY

COPYRIGHT  
U. S. A.,  
1913, 1917 AND 1918  
BY  
THE SINGER MANUFACTURING Co.  
ALL RIGHTS RESERVED FOR ALL COUNTRIES

## INDEX

---

	PAGE
ACCESSORIES .....	27
IRON BASES .....	27
KNEE LIFTER PARTS .....	28
KNEE MECHANISM FOR DISENGAGING THE FEED PAWL..	29
KNIFE GRINDER .....	29
MACHINE No. 53-1 .....	7
"    "    53-2.....	12
"    "    53-3.....	17
"    "    53-4.....	21
NUMERICAL LIST OF PARTS.....	35
OBSOLETE PARTS.....	31
THREAD UNWINDERS .....	30

# INSTRUCTIONS FOR ORDERING

In ordering from this list, use **ONLY** the part NUMBER in the **FIRST** column.

The number stamped on a Sewing Machine part is in every case the number of the single part only.

Every combination of parts sent out as such has its specific number, which, although not stamped on the parts, must be used when ordering the combination.

Each number always indicates the **SAME PART** in whatever list it appears, or for whatever machine.

The letters after some of the numbers indicate the style of finish only, as follows:

- A. Hardened, Polished and Plated.
- B. Polished and Plated
- C. Hardened only.
- D. Polished only.
- E. Soft, not Polished.
- F. Hardened and Polished.
- G.
- H. Blued.
- J. Plated only.
- K. Hardened and Plated.
- L. Brass or Gilt.
- M. Oxidized.
- P. Japanned.

These letters **MUST BE USED** when they appear in the list, and **AFTER** the number as in the list.

In this series

- 1 to 1500 and 50001 to 51500 are Screw Numbers.
- 1501 to 1800 are Nut Numbers.
- 1801 to 2000 are Roller Numbers.
- 2001 to 50000 and 52001 and upward are numbers of Machine Parts.

The figures in the second column refer only to the plates, illustrating the parts, and are **NOT TO BE USED** in ordering.

Parts marked with an asterisk (\*) are furnished only when repairs are made at factory.

# LIST OF PARTS COMPLETE

FOR

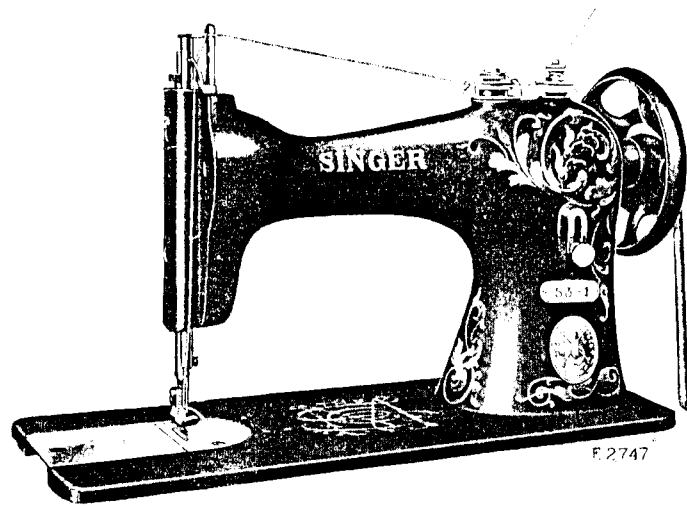

# MACHINE NO. 53-1

FOR CLOTH. DROP FEED.

NO.	PLATE	NAME	EACH
*17001	—	Arm with 450c, 2006 and 2803.....	\$4 00
4389	7640	" Dowel Pin (left).....	02
8582	1508	" " " (right).....	02
123E	1507	" Screw (left, back).....	06
880E	1507	" " (left, front).....	06
138E	1507	" " (right).....	05
13502	7641	" Shaft.....	1 25

NO.	PLATE	NAME	EACH
2006	1508	Arm Shaft Bushing (back)	\$ 15
450c	1508	" " " " Set Screw	02
*2803	—	" " " (front)	15
144d	1507	" " Screw	08
15196	7641	" Side Cover	10
286d	1507	" " " Thumb Screw	10
13503	1500	Balance Wheel, 2 $\frac{5}{16}$ in. pulley, with two 448c	1 00
448c	7640	Balance Wheel Set Screw	03
*17002	—	Bed	4 00
17011	—	" Slide	25
17012	7642	Bed Slide complete, Nos. 2824, 17011 and two 725d	30
2824	7640	Bed Slide Spring	05
725d	7640	" " " Screw	02
2811	7641	Crank Connecting Rod with 2812 and two 158E	65
*2812	—	Crank Connecting Rod Cap	—
158E	1507	" " " " Screw	03
375c	1507	" " " " Hinge Screw	12
1518E	1506	" " " " " Nut	04
13578	1500	Face Plate	45
190d	7644	" " Screw	03
2037	7641	Feed Bar	35
315c	1507	" " " Screw Centre	04
1519E	1506	" " " " Nut	03
2039	1506	" Connecting Link	15
378c	1506	" " " Hinge Screw	10
1520E	1506	" " " " " Nut	03
17003	7643	" Dog, for cloth	30
NOTE: No. 17003 is sent with this machine unless another Feed Dog is specified on order.			
17050	7643	Feed Dog, for scroll work	30
17165	7662	" " " laying braided stitching around air tucks on glove work	30
191c	1507	Feed Dog Screw	03
13758	7640	" Eccentric with 448c	25
448c	7640	" " Set Screw	03
2042	7641	" Forked Connection	50
378c	1506	" " " Hinge Screw	10
1520E	1506	" " " " " Nut	03
13508	7641	" Lifting Rock Shaft	35
13509	—	Feed Lifting Rock Shaft complete, Nos. 2509 and 13508	75
2509	1506	Feed Lifting Rock Shaft Crank with 157j and 1813	40

NO.	PLATE	NAME	EACH
157j	1506	Feed Lifting Rock Shaft Crank Clamping Screw	\$ 04
1813	1506	Feed Lifting Rock Shaft Crank Roller and Stud	20
307c	1507	Feed Lifting Rock Shaft Screw Centre (left)	06
1513j	1506	Feed Lifting Rock Shaft Screw Centre (left) Nut	05
867c	1507	Feed Lifting Rock Shaft Screw Centre (right)	10
2164	1506	Feed Regulator	20
74E	1506	" " " Hinge Screw	08
747d	1506	" " " Thumb Screw	10
2047	7641	" Rock Shaft	35
2046	—	Feed Rock Shaft complete, Nos. 2047 and 2048	50
2048	1506	Feed Rock Shaft Crank with 465c	15
2049	1506	" " " " Pin	01
465c	1506	" " " " Set Screw	02
307c	1507	" " " " Screw Centre	06
1513j	1506	" " " " " Nut	05
25527	7640	Guide	10
284d	1507	" Thumb Screw	10
13619	7640	Looper	50
13623	7640	" Carrier with 211c and 735c	50
17166	7662	" " " " " " for 17165	50
211c	7640	Looper Carrier Set Screw	02
17004	7642	" Driving Shaft	50
13519	7640	" " " Crank with 460c and 1962	50
2269	1508	Looper Driving Shaft Crank Pin	01
1962	7640	" " " " Roller and Stud	30
460c	7640	Looper Driving Shaft Crank Set Screw	02
13521	7640	" " " " Link with 329E	75
329E	7640	" " " " Adjusting Screw	02
829c	7640	Looper Driving Shaft Link Hinge Screw	10
1520E	1506	" " " " " " Nut	03
735c	7640	Looper Set Screw	02
17060	7642	Needle Bar (hollow) with 857n	50
17033	7640	" " Connecting Link with 794E	50
794E	7640	" " " " Adjusting Screw	05
881c	7640	Needle Bar Connecting Link Hinge Screw	10

NO.	PLATE	NAME	EACH
2052	7640	Needle Bar Connecting Stud with 155c	\$ 25
155c	7640	" " " " Set Screw	03
13585	1500	" " Crank with 435c and 1293c	75
1293c	7640	" " " Position Screw	10
435c	1507	" " " Set Screw	04
857h	7640	" Set Screw	02
13526	7642	Oscillating Rock Shaft	1 25
3052	7642	" " " Hinge Pin	50
1513j	1506	" " " " Nut	05
635c	1507	" " " " " Serew	
		Bearing	08
1513j	1506	Oscillating Rock Shaft Hinge Pin Screw	
		Bearing Nut	05
2058	7642	Presser Bar	30
52016	1506	" " Lifter	20
1058c	1506	" " " Hinge Screw	10
1520E	1506	" " " " " Nut	03
2952	7640	" " Lifting Bracket with 453c	25
453c	1506	" " " " Set Screw	02
2308	1506	" " Spring	05
2070	1508	" " Washer	01
17006	7643	" Foot for 17003	40
NOTE: No. 17006 is sent with this machine unless another Presser Foot is specified on order.			
17051	7643	Presser Foot for 17050	40
17167	7662	" " " 17165	1 00
190D	7644	" " Screw	03
263E	1507	Pressure Regulating Thumb Screw	20
2102	7644	Tension Disc	05
1560c	7644	" Regulating Thumb Nut	04
828c	7644	" Screw Stud	08
8238	7644	" Spring	05
17007	7644	" Thread Guide	25
17034	7644	Thread Controller Post with 13530	50
219F	7644	" " " Screw	02
13530	7644	" " Spring	05
17036	7644	" " Thread Guide	20
767D	7644	" " " " Screw	02
17035	—	Thread Controller complete, Nos. 767D, 17034 and 17036	75
1609D	7644	Thread Nipper Adjusting Thumb Nut	10
13533	7644	" " Body	35
460c	7640	" " " Set Screw	02
17153	7644	" " Cam with two 1147c	50
1147c	7644	" " " Set Screw	03
2921	7644	" " Disc	05
12162	7644	" " " Guide Pin	01

NO.	PLATE	NAME	EACH
17008	7644	Thread Nipper Eyelet	\$ 35
1527D	7644	" " Lock Nut	03
13537	—	" " Stud with 13538	25
13538	7644	" " " Position Pin	02
13539	7644	" " " Roller	10
13540	7644	" " " " Pin	02
2026	7644	" " " Spring	02
13559	7644	Thread Nipper Stud complete, Nos. 13537, 13539 and 13540	40
17009	—	Thread Nipper complete, Nos. 1527D, 1609D, 2026, 13533, 13559, 17008 and two 2921	1 30
17037	7644	Thread Take-up Plate	15
861D	7644	" " " Screw	03
17010	7643	Throat Plate for 17003	35
NOTE: No. 17010 is sent with this machine unless another Throat Plate is specified on order.			
17052	7643	Throat Plate for 17050	35
17168	7662	" " " 17165	1 00
691F	7640	" " Screw	04
13635	1514	Drip Pan with four 1 in. wire nails	20

## LIST OF PARTS COMPLETE

FOR

## MACHINE NO. 53-2

FOR CLOTH. HAS ADJUSTABLE TRIMMER AND DROP FEED.

NO.	PLATE	NAME	EACH
*17013	—	Arm with 450c, 2006 and 2803.	\$4 50
4389	7640	" Dowel Pin (left)	02
8582	1508	" " (right)	02
123E	1507	" Screw (left, back)	06
880E	1507	" " (left, front)	06
138E	1507	" " (right)	05
17038	7645	" Shaft	1 25
2006	1508	" " Bushing (back)	15
450c	1508	" " " " Set Screw	02
*2803	—	" " " (front)	15
144d	1507	" " Screw	08
15196	7641	" Side Cover	10
286d	1507	" " " Thumb Screw	10
13503	1500	Balance Wheel, 2 $\frac{3}{16}$ in. pulley, with two 448c	1 00
448c	7640	Balance Wheel Set Screw	03
*17002	—	Bed	4 00
17011	—	" Slide	25
17012	7642	Bed Slide complete, Nos. 2824, 17011 and two 725d	30
2824	7640	Bed Slide Spring	05
725d	7640	" " " Screw	02
2811	7641	Crank Connecting Rod with 2812 and two 158E	65
*2812	—	Crank Connecting Rod Cap	—
158E	1507	" " " " Screw	03
375c	1507	" " " " Hinge Screw	12
1518E	1506	" " " " " Nut	04
17014	7645	Face Plate	75
2106	7647	" " Thread Guard	01
171d	7647	" " Screw (long)	03
175E	7647	" " " (short)	02
2037	7641	Feed Bar	35
315c	1507	" " Screw Centre	04
1519E	1506	" " " " Nut	03

NO.	PLATE	NAME	EACH
2039	1506	Feed Connecting Link	\$ 15
378c	1506	" " " Hinge Screw	10
1520E	1506	" " " " " Nut	03
17154	7646	" Dog	30
191c	1507	" " Screw	03
13758	7640	" Eccentric with 448c	25
448c	7640	" " Set Screw	03
2042	7641	" Forked Connection	50
378c	1506	" " " Hinge Screw	10
1520E	1506	" " " " " Nut	03
13508	7641	" Lifting Rock Shaft	35
13509	—	Feed Lifting Rock Shaft complete, Nos. 2509 and 13508	75
2509	1506	Feed Lifting Rock Shaft Crank with 157J and 1813	40
157J	1506	Feed Lifting Rock Shaft Crank Clamping Screw	04
1813	1506	Feed Lifting Rock Shaft Crank Roller and Stud	20
307c	1507	Feed Lifting Rock Shaft Screw Centre (left)	06
1513J	1506	Feed Lifting Rock Shaft Screw Centre (left) Nut	05
867c	1507	Feed Lifting Rock Shaft Screw Centre (right)	10
2164	1506	Feed Regulator	20
74E	1506	" " Hinge Screw	08
747d	1506	" " Thumb Screw	10
2047	7641	" Rock Shaft	35
2046	—	Feed Rock Shaft complete, Nos. 2047 and 2048	50
2048	1506	Feed Rock Shaft Crank with 465c	15
2049	1506	" " " " Pin	01
465c	1506	" " " " Set Screw	02
307c	1507	" " " Screw Centre	06
1513J	1506	" " " " " Nut	05
25527	7640	Guide	10
284d	1507	" Thumb Screw	10
5726	7647	Knife	25
620c	7647	" Adjusting Screw	02
17155	7648	" Bar with 2301	1 50
17156	—	Knife Bar complete, Nos. 621d, 2298, 2299, 2648, 17155, 17157 and two 335H	4 85
17020	7647	Knife Bar Driving Crank with 1862	75
2049	1506	" " " " Position Pin	01
1862	7647	" " " " Roller (roller only)	12

## PARTS FOR MACHINE NO. 53-2

NO.	PLATE	NAME	EACH
2669	—	Knife Bar Driving Slide.....	\$1 75
2648	7647	Knife Bar Driving Slide complete, Nos. 468c, 514c, 1564d, 2296, 2297 and 2669.	2 00
514c	7647	Knife Bar Driving Slide Coupling Pin	10
2296	7647	" " " " " "	
		Bushing.....	06
468c	7647	Knife Bar Driving Slide Coupling Pin Bushing Set Screw.....	02
1564d	7647	Knife Bar Driving Slide Coupling Pin Head.....	05
2297	7647	Knife Bar Driving Slide Coupling Pin Spring.....	02
2298	7647	Knife Bar Handle.....	25
621d	7647	" " " Screw.....	02
2299	7647	" " Lifting Spring.....	02
2301	7647	" " Stop Pin.....	01
17157	7647	" Holder with 620c and two 335H....	1 00
335H	7647	" " Screw.....	02
335H	7647	" Screw.....	02
2291	7647	" " Washer.....	01
13619	7640	Looper.....	50
13623	7640	" Carrier with 211c and 735c.....	50
211c	7640	" " Set Screw.....	02
17004	7642	" Driving Shaft.....	50
13519	7640	" " " Crank with 460c and 1962.....	50
2269	1508	Looper Driving Shaft Crank Pin.....	01
1962	7640	" " " " Roller and Stud.....	30
460c	7640	Looper Driving Shaft Crank Set Screw...	02
13521	7640	" " " Link with 329E....	75
329E	7640	" " " " Adjusting Screw.....	02
829c	7640	Looper Driving Shaft Link Hinge Screw	10
1520E	1506	" " " " " "	
		Nut.....	03
735c	7640	Looper Set Screw.....	02
17027	7645	Needle Bar (hollow).....	75
2304	7647	" " Connecting Link with 329E...	60
329E	7640	" " " " Adjusting Screw.....	02
2305	7647	Needle Bar Connecting Stud with 155c...	25
155c	7640	" " " Set Screw...	03
17028	7645	" " Crank with 435c and 743c....	75
743c	1507	" " " Position Screw.....	05
435c	1507	" " " Set Screw.....	04
336H	7647	" Set Screw.....	02

## PARTS FOR MACHINE NO. 53-2

NO.	PLATE	NAME	EACH
13526	7642	Oscillating Rock Shaft.....	\$1 25
3052	7642	" " " Hinge Pin.....	50
1513J	1506	" " " " " Nut....	05
635c	1507	" " " " " Screw	
		Bearing.....	08
1513J	1506	Oscillating Rock Shaft Hinge Pin Screw Bearing Nut.....	05
17159	7645	Presser Bar.....	30
52016	1506	" " Lifter.....	20
1058c	1506	" " " Hinge Screw.....	10
1520E	1506	" " " " " Nut.....	03
2953	1506	" " Lifting Cracket with 453c...	30
453c	1506	" " " " Set Screw...	02
2308	1506	" " Spring.....	05
2070	1508	" " " Washer.....	01
17160	7646	" Foot for 17151.....	1 00
NOTE. When ordering No. 17160 state required distance of trimmed edge from seam.			
190d	7644	Presser Foot Screw.....	03
263E	1507	Pressure Regulating Thumb Screw.....	20
2102	7644	Tension Disc.....	05
1560c	7644	" Regulating Thumb Nut.....	04
828c	7644	" Screw Stud.....	08
8238	7644	" Spring.....	05
17007	7644	" Thread Guide.....	25
17034	7644	Thread Controller Post with 13530.....	50
219F	7644	" " " Screw.....	02
13530	7644	" " Spring.....	05
17036	7644	" " Thread Guide.....	20
767D	7644	" " " " Screw...	02
17035	—	Thread Controller complete, Nos. 767b, 17034 and 17036.....	75
1609D	7644	Thread Nipper Adjusting Thumb Nut...	10
13533	7644	" " Body.....	35
460c	7640	" " " Set Screw.....	02
17153	7644	" " Cam with two 1147c....	50
1147c	7644	" " " Set Screw.....	03
2921	7644	" " Disc.....	05
12162	7644	" " " Guide Pin.....	01
17008	7644	" " Eyelet.....	35
1527D	7644	" " Lock Nut.....	03
13537	—	" " Stud with 13538.....	25
13538	7644	" " " Position Pin.....	02
13539	7644	" " " Roller.....	10
13510	7644	" " " " Pin.....	02
2026	7644	" " " Spring.....	02

## PARTS FOR MACHINE NO. 53-2

NO.	PLATE	NAME	EACH
13559	7644	Thread Nipper Stud complete, Nos. 13537, 13539 and 13540.....	\$ 40
17009	—	Thread Nipper complete, Nos. 1527D, 1609D, 2026, 13533, 13559, 17008 and two 2921.....	1 30
17037	7644	Thread Take-up Plate.....	15
861D	7644	“ “ “ Screw.....	03
17161	—	Throat Plate Body.....	1 25
17162	7646	“ “ Cutting Bar.....	1 00

NOTE. When ordering No. 17162 state required distance of trimmed edge from seam.

NOTE. No. 17162,  $\frac{1}{8}$  in. gauge, is sent with this machine unless otherwise specified on order.

578D	7646	Throat Plate Cutting Bar Screw.....	02
17163	7646	“ “ Slide.....	50
236F	7646	“ “ “ Adjusting Screw.....	02
17164	7646	Throat Plate complete for 17154, Nos. 236F, 17161 to 17163 and two 578D....	2 75

NOTE. When ordering No. 17164 state required distance of trimmed edge from seam.

691F	7640	Throat Plate Screw.....	04
13635	1514	Drip Pan with four 1 in. wire nails.....	20

## LIST OF PARTS COMPLETE FOR MACHINE NO. 53-3

FOR BAG SEWING. LENGTH OF STITCH UP TO  $\frac{1}{4}$  INCH,  
DROP FEED.

NO.	PLATE	NAME	EACH
*17001	—	Arm with 450c, 2006 and 2803.....	\$4 00
4389	7640	“ Dowel Pin (left).....	02
8582	1508	“ “ “ (right).....	02
123E	1507	“ Screw (left, back).....	06
880E	1507	“ “ (left, front).....	06
138E	1507	“ “ (right).....	05
13502	7641	“ Shaft.....	1 25
2006	1508	“ “ Bushing (back).....	15
450c	1508	“ “ “ “ Set Screw....	02
*2803	—	“ “ “ (front).....	15
144D	1507	“ “ Screw.....	08
15196	7641	“ Side Cover.....	10
286D	1507	“ “ “ Thumb Screw.....	10
13503	1500	Balance Wheel, $2\frac{5}{16}$ in. pulley, with two 448c.....	1 00
448c	7640	Balance Wheel Set Screw.....	03
*17002	—	Bed.....	4 00
17011	—	“ Slide.....	25
17012	7642	Bed Slide complete, Nos. 2824, 17011 and two 725D.....	30
2824	7640	Bed Slide Spring.....	05
725D	7640	“ “ “ Screw.....	02
2811	7641	Crank Connecting Rod with 2812 and two 158e.....	65
*2812	—	Crank Connecting Rod Cap.....	—
158E	1507	“ “ “ “ Screw.....	03
375c	1507	“ “ “ “ Hinge Screw....	12
1518E	1506	“ “ “ “ “ Nut.....	04
13578	1500	Face Plate.....	45
190D	7644	“ “ Screw.....	03
17040	7642	Feed Bar.....	25
315c	1507	“ “ Screw Centre.....	04
1519E	1506	“ “ “ “ Nut.....	03
2039	1506	“ Connecting Link.....	15
378c	1506	“ “ “ “ Hinge Screw....	10
1520E	1506	“ “ “ “ “ Nut.....	03



NO.	PLATE	NAME	EACH
17041	7649	Feed Dog.....	\$ 30
NOTE. No. 17041 is sent with this machine unless another Feed Dog is specified on order.			
17053	7649	Feed Dog, for stitching on embroidery...	40
191c	1507	" " Screw.....	03
17042	7647	" Eccentric with 448c.....	25
448c	7640	" " Set Screw.....	03
17043	7642	" Forked Connection.....	50
378c	1506	" " " Hinge Screw....	10
1520E	1506	" " " " " Nut.....	03
13508	7641	" Lifting Rock Shaft.....	35
13509	—	Feed Lifting Rock Shaft complete, Nos. 2509 and 13508.....	75
2509	1506	Feed Lifting Rock Shaft Crank with 157J and 1813.....	40
157J	1506	Feed Lifting Rock Shaft Crank Clamping Screw.....	04
1813	1506	Feed Lifting Rock Shaft Crank Roller and Stud.....	20
307c	1507	Feed Lifting Rock Shaft Screw Centre (left).....	06
1513J	1506	Feed Lifting Rock Shaft Screw Centre (left) Nut.....	05
867c	1507	Feed Lifting Rock Shaft Screw Centre (right).....	10
2164	1506	Feed Regulator.....	20
74E	1506	" " Hinge Screw.....	08
747D	1506	" " Thumb Screw.....	10
2047	7641	" Rock Shaft.....	35
17045	—	Feed Rock Shaft complete, Nos. 2047 and 17044.....	50
17044	7647	Feed Rock Shaft Crank with 465c.....	15
2049	1506	" " " " Pin.....	01
465c	1506	" " " " Set Screw.....	02
307c	1507	" " " Screw Centre.....	06
1513J	1506	" " " " " Nut.....	05
25527	7640	Guide.....	10
284D	1507	" Thumb Screw.....	10
13619	7640	Looper.....	50
17059	7647	" Carrier with two 735c.....	50
735c	7640	" " Set Screw.....	02
17004	7642	" Driving Shaft.....	50
13519	7640	" " " Crank with 460c and 1962.....	50
2269	1508	Looper Driving Shaft Crank Pin.....	01
1962	7640	" " " " Roller and Stud.....	30

NO.	PLATE	NAME	EACH
460c	7640	Looper Driving Shaft Crank Set Screw...	\$ 02
13521	7640	" " " Link with 329E....	75
329E	7640	" " " " Adjusting Screw.....	02
829c	7640	Looper Driving Shaft Link Hinge Screw	10
1520E	1506	" " " " " " " Nut.....	03
735c	7640	Looper Set Screw.....	02
17060	7642	Needle Bar (hollow) with 857H.....	50
17033	7640	" " Connecting Link with 794E....	50
794E	7640	" " " " Adjusting Screw.....	05
881c	7640	Needle Bar Connecting Link Hinge Screw	10
2052	7640	" " " Stud with 155c....	25
155c	7640	" " " " Set Screw....	03
13585	1500	" " Crank with 435c and 1293c....	75
1293c	7640	" " " Position Screw.....	10
435c	1507	" " " Set Screw.....	04
857H	7640	" Set Screw.....	02
17047	7642	Oscillating Rock Shaft.....	1 25
3052	7642	" " " Hinge Pin.....	50
1513J	1506	" " " " Nut....	05
635c	1507	" " " " " Screw	08
1513J	1506	Oscillating Rock Shaft Hinge Pin Screw Bearing.....	05
2058	7642	Presser Bar.....	30
52016	1506	" " Lifter.....	20
1058c	1506	" " " Hinge Screw.....	10
1520E	1506	" " " " " Nut.....	03
2952	7640	" " Lifting Bracket with 453c....	25
453c	1506	" " " " Set Screw....	02
2308	1506	" " Spring.....	05
2070	1508	" " " Washer.....	01
17048	7649	" Foot for 17041.....	40
NOTE. No. 17048 is sent with this machine unless another Presser Foot is specified on order.			
11833	7647	Presser Foot Hinge Pin.....	01
17054	—	" " Plate.....	75
17055	—	" " Shank.....	1 00
17056	7649	Presser Foot (hinged) complete for 17053, Nos. 11833, 17054 and 17055.....	1 75
190D	7644	Presser Foot Screw.....	03
263E	1507	Pressure Regulating Thumb Screw.....	20
2102	7644	Tension Disc.....	05
1560c	7644	" Regulating Thumb Nut.....	04

NO.	PLATE	NAME	EACH
828c	7644	Tension Screw Stud .....	\$ 08
8238	7644	" Spring .....	05
17007	7644	" Thread Guide .....	25
17034	7644	Thread Controller Post with 13530 .....	50
219F	7644	" " " Screw .....	02
13530	7644	" " Spring .....	05
17036	7644	" " Thread Guide .....	20
767D	7644	" " " " Screw .....	02
17035	—	Thread Controller complete, Nos. 767D, 17034 and 17036 .....	75
1609D	7644	Thread Nipper Adjusting Thumb Nut .....	10
13533	7644	" " Body .....	35
460c	7640	" " " Set Screw .....	02
17153	7644	" " Cam with two 1147c .....	50
1147c	7644	" " " Set Screw .....	03
2921	7644	" " Disc .....	05
12162	7644	" " " Guide Pin .....	01
17008	7644	" " Eyelet .....	35
1527D	7644	" " Lock Nut .....	03
13537	—	" " Stud with 13538 .....	25
13538	7644	" " " Position Pin .....	02
13539	7644	" " " Roller .....	10
13540	7644	" " " " Pin .....	02
2026	7644	" " " Spring .....	02
13559	7644	Thread Nipper Stud complete, Nos. 13537, 13539 and 13540 .....	40
17009	—	Thread Nipper complete, Nos. 1527D, 1609D, 2026, 13533, 13559, 17008 and two 2921 .....	1 30
17037	7644	Thread Take-up Plate .....	15
861D	7644	" " " Screw .....	03
17057	7649	Throat Plate for 17053 .....	45
NOTE. No. 17057 is sent with this machine unless another Throat Plate is specified on order.			
17049	7649	Throat Plate, large needle hole, for 17041 .....	35
17058	—	" " small needle hole, for 17041 .....	35
691F	7640	" " " Screw .....	04
13635	1514	Drip Pan with four 1 in. wire nails .....	20

## LIST OF PARTS COMPLETE

FOR

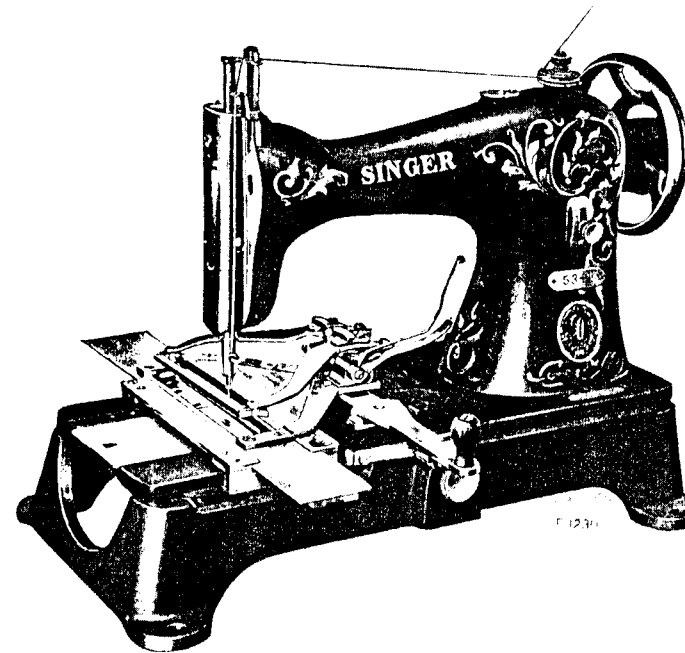

## MACHINE NO. 53-4

FOR ORNAMMENTING THE BACKS OF GLOVES WITH TAMBOUR STITCH. HAS CLAMP FOR HOLDING THE WORK IN POSITION AND AUTOMATICALLY FEEDING THE GLOVE THROUGH WHILE STITCHING. THE CLAMP IS MANUALLY RETURNED TO THE STARTING POINT FOR THE SUCCEEDING LINE OF STITCHING. THE MACHINE IS FITTED WITH MECHANISM OPERATED BY THE KNEE FOR RELEASING THE FEED PAWLS AND FEED BAR FRICTION SPRING, TO FACILITATE THE RETURN OF THE CLAMP.

NO.	PLATE	NAME	EACH
*17063	—	Arm with 450c, 2006 and 2803 .....	\$4 00
4389	7640	" Dowel Pin (left) .....	02
8582	1508	" " " (right) .....	02

NO.	PLATE	NAME	EACH
123E	1507	Arm Screw (left, back).....	\$ 06
880E	1507	" " (left, front).....	06
138E	1507	" " (right).....	05
13502	7641	" Shaft.....	1 25
2006	1508	" " Bushing (back).....	15
450C	1508	" " " " Set Screw.....	02
*2803	—	" " " (front).....	15
144D	1507	" " Screw.....	08
15196	7641	" Side Cover.....	10
286D	1507	" " " Thumb Screw.....	10
17064	7654	" Top Cover.....	05
197F	7654	" " " Screw.....	02
13503	1500	Balance Wheel, 2 $\frac{1}{8}$ in. pulley, with two 448c.....	1 00
448c	7640	Balance Wheel Set Screw.....	03
*17113	—	Bed.....	6 00
17066	—	" Slide.....	25
17067	7657	Bed Slide complete, Nos. 2824, 17066 and two 50216j.....	35
2824	7640	Bed Slide Spring.....	05
50216j	7654	" " " Screw.....	02
17114	7650	Clamp Arm (lower).....	3 00
691F	7640	" " " Screw.....	04
17115	7650	" " (upper, back) with 10165.....	1 25
17116	7650	" " (upper, front) with 10165.....	1 25
10164	7651	" " (upper) Adjusting Slide.....	15
247F	7651	" " " " " Screw.....	03
10165	7653	" " " " " " Steady Pin.....	01
10170	7651	Clamp Arm (upper) Connecting Yoke.....	20
10171	7651	" " " " " " " " " "	
		Link with two 220b.....	20
220b	7651	Clamp Arm (upper) Connecting Yoke Link Screw.....	02
10172	7651	Clamp Arm (upper) Hinge.....	20
10173	7651	" " " " " Pin.....	01
176F	7651	" " " " " Screw.....	03
10195	7653	" " " " " Spring.....	01
17117	7650	" Check Section (left).....	1 25
17117	7650	" " " (right).....	1 25
17118	7651	" " " " " Hinge Block.....	50
2653	7651	" " " " " " Pin.....	01
17119	7650	Clamp Check complete, Nos. two each 17117, 17118 and four 2653.....	3 50
401D	7651	Clamp Check Screw.....	02
17120	7651	" " Spring.....	05
17121	7652	" Cover.....	75

NO.	PLATE	NAME	EACH
1053D	7651	Clamp Cover Screw.....	\$ 02
10177	7651	" Crank Shaft.....	30
10178	7651	" " " Bracket (back).....	40
397E	7651	" " " " " Screw.....	04
10179	7651	" " " " (front).....	40
397E	7651	" " " " " Screw.....	04
17122	7651	" " " Lever with 50169b.....	75
10181	7651	" " " " " Pin.....	01
17074	7651	" " " " " Stop.....	30
32519	7651	" " " " " Pin.....	01
1182D	7651	" " " " " " Screw.....	02
50197D	7651	" " " Stop Screw.....	03
17123	7651	" Wire Guard.....	20
50169D	7651	" " " Set Screw.....	02
17124	—	Clamp complete, Nos. 1182b, 10170, 10171, 10177 to 10179, 10181, 17074, 17114 to 17116, 17119, 17121 to 17123, 32519, 50197D, two each 176F, 247F, 397E, 401D, 1053D, 10164, 10172, 10173, 10195, 17120 and four 691F.....	14 15
2811	7641	Crank Connecting Rod with 2812 and two 158E.....	65
*2812	—	Crank Connecting Rod Cap.....	—
158E	1507	" " " " " Screw.....	03
375c	1507	" " " " " Hinge Screw.....	12
1518E	1506	" " " " " " Nut.....	04
13578	1500	Face Plate.....	45
190b	7644	" " " Screw.....	03
17125	—	Feed Bar (10 stitches to the inch) with 152F, 402D, 1550H, 17136 and two 17092.....	6 00
17126	—	Feed Bar (12 stitches to the inch) with 152F, 402D, 1550H, 17136 and two 17092.....	6 00
17127	7652	Feed Bar (14 stitches to the inch) with 152F, 402D, 1550H, 17136 and two 17092.....	6 00
17128	—	Feed Bar (16 stitches to the inch) with 152F, 402D, 1550H, 17136 and two 17092.....	6 00
17129	—	Feed Bar (18 stitches to the inch) with 152F, 402D, 1550H, 17136 and two 17092.....	6 00
17130	7650	Feed Bar Carrier Block (back).....	1 00
17131	7650	" " " " " " Extension.....	20
402D	7651	" " " " " " " " " "	
		Screw.....	02
17080	7650	Feed Bar Carrier Block (front).....	1 00
17081	7650	" " " " " Cap (lower, back).....	25
207D	7651	" " " " " " " Screw.....	02
17081	7650	" " " " " (lower, front).....	25
207D	7651	" " " " " " " Screw.....	02

NO.	PLATE	NAME	EACH
17082	7650	Feed Bar Carrier Cap (upper, left).....	\$ 75
207D	7651	" " " " " " Screw	02
17083	7650	" " " " (upper, right).....	75
207D	7651	" " " " " " Screw	02
17132	—	Feed Bar Carrier complete, Nos. 402D, 17080, 17082, 17083, 17085, 17130, 17131, two each 219D, 17081 and twelve 207D.....	5 00
17085	7650	Feed Bar Carrier Connection with 1824..	75
1824	7653	" " " " Roller and Stud.....	18
219D	7644	Feed Bar Carrier Connection Screw.....	02
17086	7650	" " " Lever.....	2 00
29907	7653	" " " " Handle (wood)....	02
50089B	7653	" " " " " " Screw....	10
77D	7653	" " " " " Hinge Screw.....	06
17087	7653	" " " " " Lock Stud.....	20
17088	7653	" " " " " " Bracket	80
189D	7653	" " " " " " " "	
		Screw.....	02
17089	7653	Feed Bar Carrier Lever Lock Stud Plate	75
180F	7653	" " " " " " " "	
		Screw.....	03
10195	7653	Feed Bar Carrier Lever Lock Stud Spring	01
17090	7653	" " " " " Stop.....	1 50
213F	7653	" " " " " " Screw.....	03
17149	7652	" " " Cover.....	2 00
1443D	7653	" " " " " Screw.....	04
17133	7650	" " " Friction Spring.....	50
17134	7653	" " " " " Hook with 17135.....	30
17135	7653	Feed Bar Friction Spring Hook Stud....	05
1115F	7653	" " " " " " Screw....	04
1550H	7653	" " " " " " " Nut	03
229D	7653	" " " " " " Screw.....	02
17092	7653	" " " Pin.....	01
152F	7653	" " " Stop Screw.....	03
17136	7653	" " " " " Bracket.....	40
402D	7651	" " " " " " Screw.....	02
1550H	7653	" " " " " Nut.....	03
2039	1506	" Connecting Link.....	15
378C	1506	" " " " Hinge Screw.....	10
1520E	1506	" " " " " " Nut..	03
13758	7640	" Eccentric with 448C.....	25
448C	7640	" " " Set Screw.....	03
2042	7641	" Forked Connection.....	50
378C	1506	" " " " Hinge Screw....	10

NO.	PLATE	NAME	EACH
1520E	1506	Feed Forked Connection Hinge Screw Nut	\$ 03
17094	7653	" Pawl (left).....	1 50
50198E	7653	" " " Hinge Stud.....	03
32519	7651	" " " Stop Pin.....	01
17095	7653	" " (right) with 10165.....	1 25
50198E	7653	" " " Hinge Stud.....	03
10165	7653	" " " Stud.....	01
17137	7653	" " Carrier with 32519 and two 50198E.....	1 25
17097	7653	Feed Pawl Carrier Hinge Pin.....	15
893C	7654	" " " " " S c r e w Centre.....	04
1618E	7654	Feed Pawl Carrier Hinge Pin Screw Centre Nut.....	03
17138	7653	Feed Pawl Disengaging Lever.....	75
110C	7653	" " " " " Screw.....	04
17139	7654	" " " Plate.....	25
1053D	7651	" " " " " Screw.....	02
17101	7653	" " " Spring.....	02
665D	7653	" " " " " Screw.....	02
2164	1506	" Regulator.....	20
74E	1506	" " " Hinge Screw.....	08
747D	1506	" " " Thumb Screw.....	10
2047	7641	" Rock Shaft.....	35
2046	—	Feed Rock Shaft complete, Nos. 2047 and 2048.....	50
2048	1506	Feed Rock Shaft Crank with 465C.....	15
2049	1506	" " " " " Pin.....	01
465C	1506	" " " " " Set Screw.....	02
307C	1507	" " " " " Screw Centre.....	06
1513J	1506	" " " " " Nut.....	05
13619	7640	Looper.....	50
17059	7647	" Carrier with two 735C.....	50
735C	7640	" " " Set Screw.....	02
17004	7642	" Driving Shaft.....	50
13519	7640	" " " " Crank with 460C and 1962.....	50
2269	1508	Looper Driving Shaft Crank Pin.....	01
1962	7640	" " " " " Roller and Stud.....	30
460C	7640	Looper Driving Shaft Crank Set Screw..	02
13521	7640	" " " " " Link with 329E....	75
329E	7640	" " " " " Adjusting Screw.....	02
829C	7640	Looper Driving Shaft Link Hinge Screw	10
1520E	1506	" " " " " " " "	
		Nut.....	03

NO.	PLATE	NAME	EACH
735c	7640	Looper Set Screw	\$ 02
17102	7654	Needle Bar	50
17103	—	Needle Bar complete, Nos. 2273, 7649, 7651, 17102, 17104 and 17105	1 25
17033	7640	Needle Bar Connecting Link with 794E	50
794E	7640	" " " " Adjusting Screw	05
881c	7640	Needle Bar Connecting Link Hinge Screw	10
2052	7640	" " " Stud with 155c	25
155c	7640	" " " " Set Screw	03
13756	7648	" " Crank with 435c and 1293c	1 00
1293c	7640	" " " Position Screw	10
435c	1507	" " " Set Screw	04
17104	7654	" " Yielding Presser	50
7649	7654	" " " " Spring	05
17105	7654	" " " " " Stop	10
7651	7654	" Clamp with 206F	10
2273	7654	" " Pin	01
17140	7654	" Plate	1 00
691F	7640	" " Screw	04
206F	7654	" Set Screw	02
13526	7642	Oscillating Rock Shaft	1 25
3052	7642	" " " Hinge Pin	50
1513J	1506	" " " " Nut	05
635c	1507	" " " " " Screw	08
1513J	1506	Oscillating Rock Shaft Hinge Pin Screw Bearing Nut	05
862D	7654	Presser Bar Hole Plug Screw	05
2102	7644	Tension Disc	05
1560c	7644	" Regulating Thumb Nut	04
828c	7644	" Screw Stud	08
13710	7654	" Spring	03
17007	7644	" Thread Guide	25
17141	7654	Thread Controller Post with 17109	50
219F	7644	" " " Screw	02
17109	7654	" " Spring	05
17143	7654	" " Thread Guide	50
767D	7644	" " " " Screw	02
17142	—	Thread Controller complete, Nos. 767D, 17141 and 17143	1 00
17144	7654	Thread Take-up Plate	25
861D	7644	" " " Screw	03

## IRON BASES

NO.	PLATE	NAME	EACH
11118	1508	Bed Frame Cushion (leather)	\$ 02
7263	1508	" " Hinge Connection for 17112	08
7263	1508	" " " " (long) for 13697	08
14098	1508	Bed Frame Hinge Connection (short) for 13697	08
14008	1508	Bed Frame Hinge Connection Pin	01
970D	1508	" " Thumb Screw	20
13697	1511	" " with 970D, 2978, 7263, 14098, two 14008 and four each 11118 and wood screws 1 1/4 in. No. 12, for 53-1 to 53-3 Machines	1 25
17112	7659	Bed Frame with 970D, two each 7263, 14008 and four each 11118 and wood screws 1 1/4 in. No. 10, for 53-4 Machine	1 25
2978	1514	Drip Pan for 13697	25
17145	7660	" " " 17112	25

## ACCESSORIES

NO.	PLATE	NAME	EACH
12361	1508	Machine Hinge Connection	\$ 15
44139	1508	" " Plate	15
44140	—	Machine Hinge complete, Nos. 12361, 44139 and wood screw 1 1/4 in. No. 14	30
12405	1508	Machine Rest (felt)	02
44400	7645	" " Pin (wood) 3 1/8 in. long	04
41401	7645	" " " " 5 1/8 in. long	06
36569	5901	Oiler with 36571	05
36570	—	" 36569, filled with oil	08
36571	5901	" Spout, 1 3/4 in. long, with 36807	01
36807	7647	" " Washer (leather)	01
26026	5901	Screw Driver (large)	10
26485	5901	" " (small)	05
35143	7645	Tweezers, 4 in.	10
8909	5901	Wrench for 1513 and 1518	10
8908	5901	" " 1519, 1520 and 1618	08
25200	7648	" " 1527	10
22003	7657	" " 1550	05

## KNEE LIFTER PARTS

FOR MACHINES NOS. 53-1 TO 53-3

NO.	PLATE	NAME	EACH
5596	1500	Bell Crank.....	\$ 05
5599	1500	" " Bracket.....	08
178E	1507	" " " Screw.....	03
5601	1508	" " Hinge Pin.....	01
5735	1508	" " Spring.....	02
5598	1500	Bell Crank complete, Nos. 5596, 5599, 5601 and 5735.....	20
13587	1500	Lifting Lever.....	15
13588	7645	" " Connecting Rod.....	08
12416	1508	" " " " Joint.....	08
76D	1507	" " " " " Hinge Screw.....	06
1521E	1506	Lifting Lever Connecting Rod Lock Nut.....	03
802D	1507	" " Hinge Screw.....	10
2763	1511	Rock Shaft.....	10
12242	1511	" " Hanger with two wood screws 1 in. No. 10.....	08
2765	1511	Rock Shaft Knee Arm.....	10
2766	1511	" " " " Hub with 356c....	15
356c	1507	" " " " " Set Screw....	06
2768	—	Rock Shaft Knee Arm complete, Nos. 2765 to 2767.....	40
2767	1511	Rock Shaft Knee Plate with 356c.....	18
356c	1507	" " " " Set Screw.....	06
6337	1511	" " Lifting Bracket with two 356c	20
2778	1511	" " " " Hook.....	05
356c	1507	" " " " " S e t Screw.....	06
356c	1507	Rock Shaft Lifting Bracket Set Screw....	06
2770	1511	" " Stop Dog with 356c.....	12
356c	1507	" " " " Set Screw.....	06
2777	1511	Rock Shaft complete, Nos. 2763, 2768, 2770, 2778, 6337 and two 12242.....	1 00
17039	—	Knee Lifter complete, Nos. 76D, 802D, 1521E, 2777, 5598, 12416, 13587, 13588 and two 178E.....	1 75

## KNEE MECHANISM FOR DISENGAGING THE FEED PAWL

FOR MACHINE NO. 53-4

NO.	PLATE	NAME	EACH
17146	7659	Chain, length 5 in., with 10242.....	\$ 05
10242	7659	" Spring.....	03
7124	7659	Rock Shaft.....	10
2764	7659	" " Hanger (back) with two wood screws 1 in. No. 10.....	08
16128	7659	Rock Shaft Hanger (front) with two wood screws 1 in. No. 10.....	08
6335	7659	Rock Shaft Knee Arm.....	10
2766	7659	" " " " Hub with 356c....	15
356c	1507	" " " " Set Screw....	06
6336	—	Rock Shaft Knee Arm complete, Nos. 2766, 2767 and 6335.....	40
2767	7659	Rock Shaft Knee Plate with 356c.....	18
356c	1507	" " " " Set Screw.....	06
6337	7659	" " Lifting Bracket with two 356c	20
17147	7659	" " " " Hook.....	15
356c	1507	" " " " " S e t Screw.....	06
356c	1507	Rock Shaft Lifting Bracket Set Screw....	06
2770	7659	" " Stop Dog with 356c.....	12
356c	1507	" " " " Set Screw.....	06
17148	7659	Rock Shaft complete, Nos. 2764, 6336, 6337, 7124, 16128, 17146, 17147 and two 2770.....	1 30

## KNIFE GRINDER

FOR 5726

FOR MACHINE NO. 53-2

NO.	PLATE	NAME	EACH
27565	1104	Emery Wheel, 2 in. diam.....	\$ 25
1508c	1105	" " Clamping Nut.....	06
27822	1105	" " " " Washer....	10
27567	1105	" " Shaft.....	1 00

## KNIFE GRINDER

NO.	PLATE	NAME	EACH
27568	1105	Emery Wheel Shaft Oil Hole Cover (rubber).....	\$ 01
27569	1105	Emery Wheel Shaft Pulley.....	30
310F	1105	" " " Screw Centre.....	08
1516D	1105	" " " " " Nut.....	05
27564	1104	Frame with 27574.....	75
899D	1105	Knife Clamping Screw.....	08
27657	—	" Holder Body.....	25
27658	1105	Knife Holder complete, Nos. 899D, 27657 and 27660.....	35
27323	1105	Knife Holder Guide Bar.....	05
27572	1104	" " " " Bracket with 27574.....	30
310F	1105	Knife Holder Guide Bar Bracket Screw Centre.....	08
1516D	1105	Knife Holder Guide Bar Bracket Screw Centre Nut.....	05
27573	1105	Knife Holder Guide Bar Bracket Spring.....	05
27574	1105	" " " " " " " Hook.....	02
27659	1105	Knife Holder Stop Collar with 237F.....	10
237F	1105	" " " " Set Screw.....	02
27660	7647	" Position Pin.....	01
261D	1105	" Regulating Thumb Screw.....	12
27661	—	Knife Grinder complete, Nos. 261D, 1508C, 27323, 27564, 27565, 27567, 27569, 27572, 27573, 27658, 27659, 27662, 27822, two 27568, three wood screws 1 in. No. 10 and four each 310F and 1516D.....	4 00
27662	1104	Wrench for 1508 and 1516.....	15

## THREAD UNWINDERS

## THREAD UNWINDER

FOR ONE SMALL SPOOL

FOR MACHINES NOS. 53-1 TO 53-3

NO.	PLATE	NAME	EACH
27702	5975	Spool Pin.....	\$ 05
27442	5975	" Rest with 27702.....	10
27443	5975	" Weight with 27444 and 27445.....	25
27444	7644	" " Centre.....	10
27445	5975	" " Thread Guide.....	05
27447	5975	Thread Eyelet Rod.....	15
27446	5975	" " Wire.....	05

## THREAD UNWINDERS

NO.	PLATE	NAME	EACH
27448	—	Thread Eyelet complete, Nos. 27446 and 27447.....	\$ 20
27449	5975	Thread Unwinder complete, Nos. 27442, 27443, 27448 and two wood screws 3/4 in. No. 10.....	50

## THREAD UNWINDER

FOR ONE SMALL SPOOL

FOR MACHINE NO. 53-4

NO.	PLATE	NAME	EACH
27702	7661	Spool Pin.....	\$ 05
27442	7661	" Rest with 27702.....	10
10243	7661	" Weight.....	02
41546	7658	" " Centre Pin.....	05
41547	7661	Spool Weight complete, Nos. 10243 and 41546.....	07
27447	7661	Thread Eyelet Rod.....	15
27446	7661	" " Wire.....	05
27448	—	Thread Eyelet complete, Nos. 27446 and 27447.....	20
41541	7661	Thread Guide with 41542.....	25
41542	7651	" " Centre Pin.....	05
41807	7661	Thread Unwinder complete, Nos. 27442, 27448, 41541, 41547 and two wood screws 3/4 in. No. 10.....	60

## OBSOLETE PARTS

NO.	PLATE	NAME	EACH
2861	7648	Arm Shaft for 53-1 Machine.....	\$1 00
2261	1500	Feed Eccentric with 448C, for 53-1 and 53-2 Machines.....	25
17046	7656	Looper Carrier with 211C and 735C, for 53-3 Machine.....	50
17005	7648	Needle Bar (hollow) with 857H, for 53-1 and 53-3 Machines.....	50
290E	7656	Needle Bar Screw Bushing for 53-1 and 53-3 Machines.....	06
689C	7656	Presser Bar Lifter Screw for 53-1 to 53-3 Machines.....	10
2068	7656	Presser Bar Spring Bracket with 453C, for 53-1 Machine.....	25

## OBSOLETE PARTS

NO.	PLATE	NAME	EACH
453c	1506	Presser Bar Spring Bracket Set Screw for 2068	\$ 02
13529	7656	Thread Controller Post with 13530, for 13531	40
400f	7656	Thread Controller Post Screw for 53-1 Machine	02
13531	—	Thread Controller complete for 53-1 Machine, Nos. 337D, 13529 and 13532	65
13532	1508	Thread Controller Thread Guide for 13531	20
337D	7656	Thread Controller Thread Guide Screw for 13531	02
13534	7656	Thread Nipper Cam with 882c, for 53-1 to 53-3 Machines	35
13759	7656	Thread Nipper Cam with two 1147c, for 53-1 to 53-3 Machines	50
882c	7656	Thread Nipper Cam Set Screw for 13534	02
13542	1508	" Take-up Plate for 53-1 Machine	10

## FOR MACHINE NO. 53-2

17015	7655	Feed Dog, for cloth	30
17016	7656	Knife (movable)	20
17017	7656	" (stationary)	25
17018	7648	" Bar with 2301	1 50
17019	—	Knife Bar complete, Nos. 621D, 2295, 2298, 2299, 17018, 17023 to 17025 and two each 330D and 335D	6 00
2338	—	Knife Bar Driving Slide	1 75
2295	7656	Knife Bar Driving Slide complete for 17019, Nos. 468c, 514c, 1564D, 2296, 2297 and 2338	2 00
17021	7656	Knife Clamp for 17017	1 00
330D	7656	" " Screw	02
17022	7656	" " Washer	01
17023	7656	" Holder	75
17024	7656	" " Bracket	1 25
335D	7647	" " " Screw	02
330D	7656	" " Stop Screw	02
17025	7656	" " Spring	02
17029	7656	" " Guide Pin	02
17026	7656	" Interposer	10
330D	7656	" Screw	02
13513	7656	Looper	50
13514	7656	" Carrier with 211c and 735c	1 00
17030	7648	Presser Bar	35
15072	7655	" Foot Hinge Pin.....per 100	10

## OBSOLETE PARTS

NO.	PLATE	NAME	EACH
17061	—	Presser Foot Plate	\$1 00
17062	—	" " Shank	2 00
10135	7655	" " Spring	01
15072	7655	" " " Hook.....per 100	10
17031	7655	Presser Foot (spring hinged) complete for 17015, Nos. 10135, 17061, 17062 and three 15072	3 00
17032	7655	Throat Plate for 17015	35

## FOR MACHINE NO. 53-4

*17065	—	Bed	6 00
17068	7657	Clamp Arm (lower)	3 00
17069	7657	" " (upper, back) with 10165	1 25
17070	7657	" " (upper, front) with 10165	1 25
17071	7657	" Check	1 75
402D	7651	" " Screw	02
17072	7657	" Cover	75
17073	7658	" Crank Shaft Lever	75
17075	—	Clamp complete, Nos. 1182D, 10170, 10174, 10177 to 10179, 10181, 17068 to 17074, 32519, 50197D, two each 176F, 247F, 397E, 402D, 1053D, 10164, 10172, 10173, 10195 and four 691F	11 80
17076	7657	Feed Bar (10 stitches to the inch) with 207D, 1159F, 1550H, 17093 and two 17092	6 00
17077	—	Feed Bar (12 stitches to the inch) with 207D, 1159F, 1550H, 17093 and two 17092	6 00
17078	—	Feed Bar (14 stitches to the inch) with 207D, 1159F, 1550H, 17093 and two 17092	6 00
17079	—	Feed Bar (16 stitches to the inch) with 207D, 1159F, 1550H, 17093 and two 17092	6 00
17080	7650	Feed Bar Carrier Block (back)	1 00
17084	—	Feed Bar Carrier complete, Nos. 17082, 17083, 17085, two each 219D, 17080, 17081 and twelve 207D	5 00
17091	7658	Feed Bar Friction Spring	25
240D	7658	" " " " Screw	02
17150	7658	" " Spring	25
756D	7658	" " " Screw	02
1159F	7658	" " Stop Screw	03
17093	7658	" " " " Bracket	40
207D	7651	" " " " " Screw	02



## OBSOLETE PARTS

NO.	PLATE	NAME	EACH
17042	7647	Feed Eccentric with 448c.....	\$ 25
17096	7658	" Pawl Carrier with 32519 and two 50198E.....	1 00
17098	7658	Feed Pawl Carrier Stop.....	40
233b	7658	" " " " Screw.....	02
17099	7658	" " Disengaging Slide.....	75
1451H	7658	" " " " Screw.....	05
10195	7653	" " " " Spring.....	01
17100	7658	" " Plate.....	25
240b	7658	" " Spring Screw.....	02
13623	7640	Looper Carrier with 211c and 735c.....	50
17106	7658	Needle Plate, large needle hole.....	1 00
17107	---	" " small needle hole.....	1 00
17108	7658	Thread Controller Post with 17109.....	50
17110	---	Thread Controller complete, Nos. 767d, 17108 and 17111.....	1 00
17111	7658	Thread Controller Thread Guide.....	50
17037	7644	" Take-up Plate.....	15

**NUMERICAL LIST OF PARTS**  
**FOR**  
**MACHINES Nos. 53-1 to 53-4**

## NUMERICAL LIST OF PARTS

NO.	PLATE	NAME	EACH
74E	1506	Feed Regulator Hinge Screw	\$ 08
76D	1507	Lifting Lever Connecting Rod Joint Hinge Screw for 17039	06
77D	7653	Feed Bar Carrier Lever Hinge Screw for 53-4 Machine	06
110c	7653	Feed Pawl Disengaging Lever Screw for 53-4 Machine	04
123E	1507	Arm Screw (left, back)	06
138E	1507	" " (right)	05
144D	1507	" Shaft Screw	08
152F	7653	Feed Bar Stop Screw for 17125 to 17129	03
155c	7640	Needle Bar Connecting Stud Set Screw for 2052 and 2305	03
157J	1506	Feed Lifting Rock Shaft Crank Clamping Screw for 2509	04
158E	1507	Crank Connecting Rod Cap Screw for 2811	03
171D	7647	Face Plate Screw (long) for 53-2 Machine	03
175E	7647	" " " (short) for 53-2 Machine	02
176F	7651	Clamp Arm (upper) Screw for 17075 and 17124	03
178E	1507	Bell Crank Bracket Screw for 17039	03
180F	7653	Feed Bar Carrier Lever Lock Stud Plate Screw for 53-4 Machine	03
189D	7653	Feed Bar Carrier Lever Lock Stud Bracket Screw for 53-4 Machine	02
190D	7644	Face Plate Screw for 53-1, 53-3 and 53-4 Machines	03
190D	7644	Presser Foot Screw for 53-1 to 53-3 Machines	03
191C	1507	Feed Dog Screw for 53-1 to 53-3 Machines	03
197F	7654	Arm Top Cover Screw for 53-4 Machine	02
206F	7654	Needle Set Screw for 7651	02
207D	7651	Feed Bar Carrier Cap (lower, back) Screw for 17084 and 17132	02
207D	7651	Feed Bar Carrier Cap (lower, front) Screw for 17084 and 17132	02
207D	7651	Feed Bar Carrier Cap (upper, left) Screw for 17084 and 17132	02
207D	7651	Feed Bar Carrier Cap (upper, right) Screw for 17084 and 17132	02

## NUMERICAL LIST OF PARTS

NO.	PLATE	NAME	EACH
207D	7651	Feed Bar Stop Screw Bracket Screw for 17076 to 17079, obsolete	\$ 02
211c	7640	Looper Carrier Set Screw for 13514, 13623, 17046 and 17166	02
213F	7653	Feed Bar Carrier Lever Stop Screw for 53-4 Machine	03
219D	7644	Feed Bar Carrier Connection Screw for 17084 and 17132	02
219F	7644	Thread Controller Post Screw	02
220D	7651	Clamp Arm (upper) Connecting Yoke Link Screw for 10171	02
229D	7653	Feed Bar Friction Spring Screw for 53-4 Machine	02
233D	7658	Feed Pawl Carrier Stop Screw for 53-4 Machine, obsolete	02
236F	7646	Throat Plate Slide Adjusting Screw for 17164	02
237F	1105	Knife Grinder Knife Holder Stop Collar Set Screw for 27659	02
240D	7658	Feed Bar Friction Spring Screw for 53-4 Machine, obsolete	02
240D	7658	Feed Pawl Spring Screw for 53-4 Machine, obsolete	02
247F	7651	Clamp Arm (upper) Adjusting Slide Screw for 17075 and 17124	03
261D	1105	Knife Grinder Knife Regulating Thumb Screw for 27661	12
263E	1507	Pressure Regulating Thumb Screw for 53-1 to 53-3 Machines	20
284D	1507	Guide Thumb Screw for 53-1 to 53-3 Machines	10
286D	1507	Arm Side Cover Thumb Screw	10
290E	7656	Needle Bar Screw Bushing for 53-1 and 53-3 Machines, obsolete	06
307c	1507	Feed Lifting Rock Shaft Screw Centre (left) for 53-1 to 53-3 Machines	06
307c	1507	Feed Rock Shaft Screw Centre	06
310F	1105	Knife Grinder Emery Wheel Shaft Screw Centre for 27661	08
310F	1105	Knife Grinder Knife Holder Guide Bar Bracket Screw Centre for 27661	08
315c	1507	Feed Bar Screw Centre for 53-1 to 53-3 Machines	04
329E	7640	Looper Driving Shaft Link Adjusting Screw for 13521	02
329E	7640	Needle Bar Connecting Link Adjusting Screw for 2304	02

## NUMERICAL LIST OF PARTS

NO.	PLATE	NAME	EACH
330D	7656	Knife Clamp Screw for 53-2 Machine, obsolete	\$ 02
330D	7656	Knife Holder Stop Screw for 17019, obsolete	02
330D	7656	Knife Screw for 17019, obsolete	02
335H	7647	" Holder Screw for 17156	02
335H	7647	" Screw for 17157	02
335D	7647	" Holder Bracket Screw for 17019, obsolete	02
336H	7647	Needle Set Screw for 53-2 Machine	02
337D	7656	Thread Controller Thread Guide Screw for 13531, obsolete	02
356c	1507	Rock Shaft Knee Arm Hub Set Screw for 2766	06
356c	1507	Rock Shaft Knee Plate Set Screw for 2767	06
356c	1507	Rock Shaft Lifting Bracket Hook Set Screw for 6337	06
356c	1507	Rock Shaft Lifting Bracket Set Screw for 6337	06
356c	1507	Rock Shaft Stop Dog Set Screw for 2770	06
375c	1507	Crank Connecting Rod Hinge Screw	12
378c	1506	Feed Connecting Link Hinge Screw	10
378c	1506	" Forked Connection Hinge Screw	10
397E	7651	Clamp Crank Shaft Bracket (back) Screw for 17075 and 17124	04
397E	7651	Clamp Crank Shaft Bracket (front) Screw for 17075 and 17124	04
400F	7656	Thread Controller Post Screw for 53-1 Machine, obsolete	02
401D	7651	Clamp Check Screw for 17124	02
402D	7651	" " " " 17075, obsolete	02
402D	7651	Feed Bar Carrier Block (back) Extension Screw for 17132	02
402D	7651	Feed Bar Stop Screw Bracket Screw for 17125 to 17129	02
435c	1507	Needle Bar Crank Set Screw for 13585, 13756 and 17028	04
448c	7640	Balance Wheel Set Screw for 13503	03
448c	7640	Feed Eccentric Set Screw for 2261, 13758 and 17042	03
450c	1508	Arm Shaft Bushing (back) Set Screw for 17001, 17013 and 17063	02
453c	1506	Presser Bar Lifting Bracket Set Screw for 2952 and 2953	02
453c	1506	Presser Bar Spring Bracket Set Screw for 2068, obsolete	02

NO.	PLATE	NAME	EACH
460c	7640	Looper Driving Shaft Crank Set Screw for 13519.....	\$ 02
460c	7640	Thread Nipper Body Set Screw for 53-1 to 53-3 Machines.....	02
465c	1506	Feed Rock Shaft Crank Set Screw for 2048 and 17044.....	02
468c	7647	Knife Bar Driving Slide Coupling Pin Bushing Set Screw for 2295 and 2648..	02
514c	7647	Knife Bar Driving Slide Coupling Pin for 2295 and 2648.....	10
578E	7646	Throat Plate Cutting Bar Screw for 17164	02
620c	7647	Knife Adjusting Screw for 17157.....	02
621D	7647	" Bar Handle Screw for 17019 and 17156.....	02
635c	1507	Oscillating Rock Shaft Hinge Pin Screw Bearing.....	08
665D	7653	Feed Pawl Spring Screw for 53-4 Machine	02
689c	7656	Presser Bar Lifter Screw for 53-1 to 53-3 Machines, obsolete.....	10
691F	7640	Clamps Arm (lower) Screw for 17075 and 17124.....	04
691F	7640	Needle Plate Screw for 53-4 Machine.....	04
691F	7640	Throat Plate Screw for 53-1 to 53-3 Machines.....	04
725D	7640	Bed Slide Spring Screw for 17012.....	02
735c	7640	Looper Carrier Set Screw for 17059.....	02
735c	7640	" Set Screw for 13514, 13623, 17046, 17059 and 17166.....	02
743c	1507	Needle Bar Crank Position Screw for 17028.....	05
747D	1506	Feed Regulator Thumb Screw.....	10
756D	7658	" Bar Spring Screw for 53-4 Machine, obsolete.....	02
767D	7644	Thread Controller Thread Guide Screw for 17035, 17110 and 17142.....	02
794E	7640	Needle Bar Connecting Link Adjusting Screw for 17033.....	05
802D	1507	Lifting Lever Hinge Screw for 17039.....	10
828c	7644	Tension Screw Stud.....	08
829c	7640	Looper Driving Shaft Link Hinge Screw.	10
857H	7640	Needle Set Screw for 17005 and 17060..	02
861D	7644	Thread Take-up Plate Screw.....	03
862D	7654	Presser Bar Hole Plug Screw for 53-4 Machine.....	05
867c	1507	Feed Lifting Rock Shaft Screw Centre (right) for 53-1 to 53-3 Machines.....	10
880E	1507	Arm Screw (left, front).....	06

NO.	PLATE	NAME	EACH
881c	7640	Needle Bar Connecting Link Hinge Screw for 53-1, 53-3 and 53-4 Machines.....	\$ 10
882c	7656	Thread Nipper Cam Set Screw for 13534, obsolete.....	02
893c	7654	Feed Pawl Carrier Hinge Pin Screw Centre for 53-4 Machine.....	01
899D	1105	Knife Grinder Knife Clamping Screw for 27658.....	08
970D	1508	Bed Frame Thumb Screw for 13697 and 17112.....	20
1053D	7651	Clamp Cover Screw for 17075 and 17124.	02
1053D	7651	Feed Pawl Plate Screw for 53-4 Machine.	02
1058c	1506	Presser Bar Lifter Hinge Screw for 53-1 to 53-3 Machines.....	10
1115F	7653	Feed Bar Friction Spring Hook Screw for 53-4 Machine.....	04
1147c	7644	Thread Nipper Cam Set Screw for 13759 and 17153.....	03
1159F	7658	Feed Bar Stop Screw for 17076 to 17079, obsolete.....	03
1182D	7651	Clamp Crank Shaft Lever Stop Screw for 17075 and 17124.....	02
1293c	7640	Needle Bar Crank Position Screw for 13585 and 13756.....	10
1443D	7653	Feed Bar Cover Screw for 53-4 Machine.	04
1451H	7658	" Pawl Disengaging Slide Screw for 53-4 Machine, obsolete.....	05
1508c	1105	Knife Grinder Emery Wheel Clamping Nut for 27661.....	06
1513J	1506	Feed Lifting Rock Shaft Screw Centre (left) Nut for 53-1 to 53-3 Machines...	05
1513J	1506	Feed Rock Shaft Screw Centre Nut.....	05
1513J	1506	Oscillating Rock Shaft Hinge Pin Nut...	05
1513J	1506	" " " " " Screw Bearing Nut.....	05
1516D	1105	Knife Grinder Emery Wheel Shaft Screw Centre Nut for 27661.....	05
1516D	1105	Knife Grinder Knife Holder Guide Bar Bracket Screw Centre Nut for 27661...	05
1518E	1506	Crank Connecting Rod Hinge Screw Nut	04
1519E	1506	Feed Bar Screw Centre Nut for 53-1 to 53-3 Machines.....	03
1520E	1506	Feed Connecting Link Hinge Screw Nut.	03
1520E	1506	" Forked Connection Hinge Screw Nut.....	03
1520E	1506	Looper Driving Shaft Link Hinge Screw Nut.....	03

## NUMERICAL LIST OF PARTS

NO.	PLATE	NAME	EACH
1520E	1506	Presser Bar Lifter Hinge Screw Nut for 53-1 to 53-3 Machines.....	\$ 03
1521E	1506	Lifting Lever Connecting Rod Lock Nut for 17039.....	03
1527D	7644	Thread Nipper Lock Nut for 17009.....	03
1550H	7653	Feed Bar Friction Spring Hook Screw Nut for 53-4 Machine.....	03
1550H	7653	Feed Bar Stop Screw Nut for 17076 to 17079 and 17125 to 17129.....	03
1560C	7644	Tension Regulating Thumb Nut.....	04
1564D	7647	Knife Bar Driving Slide Coupling Pin Head for 2295 and 2648.....	05
1609D	7644	Thread Nipper Adjusting Thumb Nut for 17009.....	10
1618E	7654	Feed Pawl Carrier Hinge Pin Screw Centre Nut for 53-4 Machine.....	03
1813	1506	Feed Lifting Rock Shaft Crank Roller and Stud for 2509.....	20
1824	7653	Feed Bar Carrier Connection Roller and Stud for 17085.....	18
1862	7647	Knife Bar Driving Crank Roller (roller only) for 17020.....	12
1962	7640	Looper Driving Shaft Crank Roller and Stud for 13519.....	30
2006	1508	Arm Shaft Bushing (back) for 17001, 17013 and 17063.....	15
2026	7644	Thread Nipper Stud Spring for 17009....	02
2037	7641	Feed Bar for 53-1 and 53-2 Machines....	35
2039	1506	" Connecting Link.....	15
2042	7641	" Forked Connection for 53-1, 53-2 and 53-4 Machines.....	50
2046	—	Feed Rock Shaft complete for 53-1, 53-2 and 53-4 Machines, Nos. 2047 and 2048	50
2047	7641	Feed Rock Shaft for 2046 and 17045....	35
2048	1506	" " " Crank with 465c, for 2046.....	15
2049	1506	Feed Rock Shaft Crank Pin.....	01
2049	1506	Knife Bar Driving Crank Position Pin for 53-2 Machine.....	01
2052	7640	Needle Bar Connecting Stud with 155c, for 53-1, 53-3 and 53-4 Machines.....	25
2058	7642	Presser Bar for 53-1 and 53-3 Machines..	30
2068	7656	" " Spring Bracket with 453c, for 53-1 Machine, obsolete.....	25
2070	1508	Presser Bar Spring Washer for 53-1 to 53-3 Machines.....	01
2102	7644	Tension Disc.....	05

## NUMERICAL LIST OF PARTS

NO.	PLATE	NAME	EACH
2106	7647	Face Plate Thread Guard for 53-2 Machine.....	\$ 01
2164	1506	Feed Regulator.....	20
2261	1500	" Eccentric with 448c, for 53-1 and 53-2 Machines, obsolete.....	25
2269	1508	Looper Driving Shaft Crank Pin.....	01
2273	7654	Needle Clamp Pin for 17103.....	01
2291	7647	Knife Screw Washer for 53-2 Machine...	01
2295	7656	Knife Bar Driving Slide complete for 17019, Nos. 468c, 514c, 1564D, 2296, 2297 and 2338, obsolete.....	2 00
2296	7647	Knife Bar Driving Slide Coupling Pin Bushing for 2295 and 2648.....	06
2297	7647	Knife Bar Driving Slide Coupling Pin Spring for 2295 and 2648.....	02
2298	7647	Knife Bar Handle for 17019 and 17156...	25
2299	7647	" " Lifting Spring for 17019 and 17156.....	02
2301	7647	Knife Bar Stop Pin for 17018 and 17155.	01
2304	7647	Needle Bar Connecting Link with 329E, for 53 2 Machine.....	60
2305	7647	Needle Bar Connecting Stud with 155c, for 53 2 Machine.....	25
2308	1506	Presser Bar Spring for 53-1 to 53-3 Machines.....	05
2338	—	Knife Bar Driving Slide for 2295, obsolete	1 75
2509	1506	Feed Lifting Rock Shaft Crank with 157J and 1813, for 13509.....	40
2648	7647	Knife Bar Driving Slide complete for 17156, Nos. 468c, 514c, 1564D, 2296, 2297 and 2669.....	2 00
2653	7651	Clamp Check Section Hinge Pin for 17119	01
2669	—	Knife Bar Driving Slide for 2648.....	1 75
2763	1511	Rock Shaft for 2777.....	10
2764	7659	" " Hanger (back) with two wood screws 1 in. No. 10, for 17148.....	08
2765	1511	Rock Shaft Knee Arm for 2768.....	10
2766	1511	" " " " Hub with 356c, for 2768 and 6336.....	15
2767	1511	Rock Shaft Knee Plate with 356c, for 2768 and 6336.....	18
2768	—	Rock Shaft Knee Arm complete for 2777, Nos. 2765 to 2767.....	40
2770	1511	Rock Shaft Stop Dog with 356c, for 2777 and 17148.....	12
2777	1511	Rock Shaft complete for 17039, Nos. 2763, 2768, 2770, 2778, 6337 and two 12242..	1 00

## NUMERICAL LIST OF PARTS

NO.	PLATE	NAME	EACH
2778	1511	Rock Shaft Lifting Bracket Hook for 2777	\$ 05
*2803	—	Arm Shaft Bushing (front) for 17001, 17013 and 17063	15
2811	7641	Crank Connecting Rod with 2812 and two 158E	65
*2812	—	Crank Connecting Rod Cap for 2811	—
2824	7640	Bed Slide Spring for 17012 and 17067	05
2861	7648	Arm Shaft for 53-1 Machine, obsolete	1 00
2921	7644	Thread Nipper Disc for 17009	05
2952	7640	Presser Bar Lifting Bracket with 453c, for 53-1 and 53-3 Machines	25
2953	1506	Presser Bar Lifting Bracket with 453c, for 53-2 Machine	30
2978	1514	Drip Pan for 13697	25
3052	7642	Oscillating Rock Shaft Hinge Pin	50
4389	7640	Arm Dowel Pin (left)	02
5596	1500	Bell Crank for 5598	05
5598	1500	Bell Crank complete for 17039, Nos. 5596, 5599, 5601 and 5735	20
5599	1500	Bell Crank Bracket for 5598	08
5601	1508	" " Hinge Pin for 5598	01
5726	7647	Knife for 53-2 Machine	25
5735	1508	Bell Crank Spring for 5598	02
6335	7659	Rock Shaft Knee Arm for 6336	10
6336	—	Rock Shaft Knee Arm complete for 17148, Nos. 2766, 2767 and 6335	40
6337	1511	Rock Shaft Lifting Bracket with two 356c, for 2777 and 17148	20
7124	7659	Rock Shaft for 17148	10
7263	1508	Bed Frame Hinge Connection for 17112	08
7263	1508	" " " " (long) for 13697	08
7649	7654	Needle Bar Yielding Presser Spring for 17103	05
7651	7654	Needle Clamp with 206F, for 17103	10
8238	7644	Tension Spring for 53-1 to 53-3 Machines	05
8582	1508	Arm Dowel Pin (right)	02
8908	5901	Wrench for 1519, 1520 and 1618 (Accessories)	08
8909	5901	Wrench for 1513 and 1518 (Accessories)	10
10135	7655	Presser Foot Spring for 17031, obsolete	01
10164	7651	Clamp Arm (upper) Adjusting Slide for 17075 and 17124	15
10165	7653	Clamp Arm (upper) Adjusting Slide Steady Pin for 17069, 17070, 17115 and 17116	01

## NUMERICAL LIST OF PARTS

NO.	PLATE	NAME	EACH
10165	7653	Feed Pawl (right) Stud for 17095	\$ 01
		Nos. 10170 TO 10173 FOR 17075 AND 17124.	
10170	7651	Clamp Arm (upper) Connecting Yoke	20
10171	7651	" " " " " Link with two 220D	20
10172	7651	Clamp Arm (upper) Hinge	20
10173	7651	" " " " Pin	01
		Nos. 10177 TO 10179 FOR 17075 AND 17124.	
10177	7651	Clamp Crank Shaft	30
10178	7651	" " " Bracket (back)	40
10179	7651	" " " " (front)	40
10181	7651	" " " Lever Pin for 17075 and 17124	01
10195	7653	Clamp Arm (upper) Spring for 17075 and 17124	01
10195	7653	Feed Bar Carrier Lever Lock Stud Spring for 53-4 Machine	01
10195	7653	Feed Pawl Disengaging Slide Spring for 53-4 Machine, obsolete	01
10242	7659	Chain Spring for 17146	03
10243	7661	Thread Unwinder Spool Weight for 41547	02
11118	1508	Bed Frame Cushion (leather) for 13697 and 17112	02
11833	7647	Presser Foot Hinge Pin for 17056	01
12162	7644	Thread Nipper Disc Guide Pin for 53-1 to 53-3 Machines	01
12242	1511	Rock Shaft Hanger with two wood screws 1 in. No. 10, for 2777	08
12361	1508	Machine Hinge Connection for 44140	15
12405	1508	" Rest, felt (Accessories)	02
12416	1508	Lifting Lever Connecting Rod Joint for 17039	08
13502	7641	Arm Shaft for 53-1, 53-3 and 53-4 Machines	1 25
13503	1500	Balance Wheel, 2 $\frac{5}{8}$ in. pulley, with two 448c	1 00
13508	7641	Feed Lifting Rock Shaft for 13509	35
13509	—	Feed Lifting Rock Shaft complete for 53-1 to 53-3 Machines, Nos. 2509 and 13508	75
13513	7656	Looper for 53-2 Machine, obsolete	50
13514	7656	" Carrier with 211c and 735c, for 53-2 Machine, obsolete	1 00
13519	7640	Looper Driving Shaft Crank with 460c and 1962	50
13521	7640	Looper Driving Shaft Link with 329E	75

## NUMERICAL LIST OF PARTS

NO.	PLATE	NAME	EACH
13526	7642	Oscillating Rock Shaft for 53-1, 53-2 and 53-4 Machines.	\$1 25
13529	7656	Thread Controller Post with 13530, for 13531, obsolete.	40
13530	7644	Thread Controller Spring for 13529 and 17034.	05
13531	—	Thread Controller complete for 53-1 Machine, Nos. 337b, 13529 and 13532, obsolete.	65
13532	1508	Thread Controller Thread Guide for 13531, obsolete.	20
13533	7644	Thread Nipper Body for 17009.	35
13534	7656	" " Cam with 882c, for 53-1 to 53-3 Machines, obsolete.	35
13537	—	Thread Nipper Stud with 13538, for 13559	25
13538	7644	" " " Position Pin for 13537	02
13539	7644	" " " Roller for 13559	10
13540	7644	" " " " Pin for 13559	02
13542	1508	" " Take-up Plate for 53-1 Machine, obsolete.	10
13559	7644	Thread Nipper Stud complete for 17009, Nos. 13537, 13539 and 13540.	40
13578	1500	Face Plate for 53-1, 53-3 and 53-4 Machines.	45
13585	1500	Needle Bar Crank with 435c and 1293c, for 53-1 and 53-3 Machines.	75
13587	1500	Lifting Lever for 17039.	15
13588	7645	" " Connecting Rod for 17039.	08
13619	7640	Looper.	50
13623	7640	" Carrier with 211c and 735c, for 53-1 and 53-2 Machines and obsolete for 53-4 Machine.	50
13635	1514	Drip Pan with four 1 in. wire nails, for 53-1 to 53-3 Machines.	20
13697	1511	Bed Frame with 970b, 2978, 7263, 14098, two 14008 and four each 11118 and wood screws 1¼ in. No. 12, for 53-1 to 53-3 Machines.	1 25
13710	7654	Tension Spring for 53-4 Machine.	03
13756	7648	Needle Bar Crank with 435c and 1293c, for 53-4 Machine.	1 00
13758	7640	Feed Eccentric with 448c, for 53-1, 53-2 and 53-4 Machines.	25
13759	7656	Thread Nipper Cam with two 1147c, for 53-1 to 53-3 Machines, obsolete.	50
14008	1508	Bed Frame Hinge Connection Pin for 13697 and 17112.	01

## NUMERICAL LIST OF PARTS

NO.	PLATE	NAME	EACH
14098	1508	Bed Frame Hinge Connection (short) for 13697.	\$ 08
15072	7655	Presser Foot Hinge Pin for 17031, obsolete.	per 100 10
15072	7655	Presser Foot Spring Hook for 17031, obsolete.	per 100 10
15196	7641	Arm Side Cover.	10
16128	7659	Rock Shaft Hanger (front) with two wood screws 1 in. No. 10, for 17148.	08
*17001	—	Arm with 450c, 2006 and 2803, for 53-1 and 53-3 Machines.	4 00
*17002	—	Bed for 53-1 to 53-3 Machines.	4 00
17003	7643	Feed Dog, for cloth, for 53-1 Machine.	30
17004	7642	Looper Driving Shaft.	50
17005	7648	Needle Bar (hollow) with 857n, for 53-1 and 53-3 Machines, obsolete.	50
17006	7643	Presser Foot for 17003.	40
17007	7644	Tension Thread Guide.	25
17008	7644	Thread Nipper Eyelet for 17009.	35
17009	—	Thread Nipper complete for 53-1 to 53-3 Machines, Nos. 1527b, 1609b, 2026, 13533, 13559, 17008 and two 2921.	1 30
17010	7643	Throat Plate for 17003.	35
17011	—	Bed Slide for 17012.	25
17012	7642	Bed Slide complete for 53-1 to 53-3 Machines, Nos. 2824, 17011 and two 725b.	30
Nos. 17013 TO 17022 FOR 53-2 MACHINE.			
*17013	—	Arm with 450c, 2006 and 2803.	4 50
17014	7645	Face Plate.	75
17015	7655	Feed Dog, for cloth, obsolete.	30
17016	7656	Knife (movable) obsolete.	20
17017	7656	" (stationary) obsolete.	25
17018	7648	" Bar with 2301, for 17019, obsolete.	1 50
17019	—	Knife Bar complete, Nos. 621b, 2295, 2298, 2299, 17018, 17023 to 17025 and two each 330b and 335b, obsolete.	6 00
17020	7647	Knife Bar Driving Crank with 1862.	75
17021	7656	" Clamp for 17017, obsolete.	1 00
17022	7656	" " Screw Washer, obsolete.	01
Nos. 17023 TO 17025 FOR 17019, OBSOLETE.			
17023	7656	Knife Holder.	75
17024	7656	" " Bracket.	1 25
17025	7656	" " Spring.	02
Nos. 17026 TO 17032 FOR 53-2 MACHINE.			
17026	7656	Knife Interposer, obsolete.	10

## NUMERICAL LIST OF PARTS

NO.	PLATE	NAME	EACH
17027	7645	Needle Bar (hollow).....	\$ 75
17028	7645	“ “ Crank with 435c and 743c...	75
17029	7656	Knife Holder Spring Guide Pin, obsolete.	02
17030	7648	Presser Bar, obsolete.....	35
17031	7655	Presser Foot (spring hinged) complete for 17015, Nos. 10135, 17061, 17062 and three 15072, obsolete.....	3 00
17032	7655	Throat Plate for 17015, obsolete.....	35
17033	7640	Needle Bar Connecting Link with 794E, for 53-1, 53-3 and 53-4 Machines.....	50
17034	7644	Thread Controller Post with 13530, for 17035.....	50
17035	—	Thread Controller complete for 53-1 to 53-3 Machines, Nos. 767D, 17034 and 17036.....	75
17036	7644	Thread Controller Thread Guide for 17035	20
17037	7644	“ Take-up Plate for 53-1 to 53-3 Machines and obsolete for 53-4 Machine	15
17038	7645	Arm Shaft for 53-2 Machine.....	1 25
17039	—	Knee Lifter complete for 53-1 to 53-3 Machines, Nos. 76D, 802D, 1521E, 2777, 5598, 12416, 13587, 13588 and two 178E	1 75
17040	7642	Feed Bar for 53-3 Machine.....	25
17041	7649	“ Dog for 53-3 Machine.....	30
17042	7647	“ Eccentric with 448c, for 53-3 Machine and obsolete for 53-4 Machine	25
Nos. 17043 to 17049 FOR 53-3 MACHINE.			
17043	7642	Feed Forked Connection.....	50
17044	7647	“ Rock Shaft Crank with 465c, for 17045.....	15
17045	—	Feed Rock Shaft complete, Nos. 2047 and 17044.....	50
17046	7656	Looper Carrier with 211c and 735c, obsolete.....	50
17047	7642	Oscillating Rock Shaft.....	1 25
17048	7649	Presser Foot for 17041.....	40
17049	7649	Throat Plate, large needle hole, for 17041.	35
17050	7643	Feed Dog, for scroll work, for 53-1 Machine.....	30
17051	7643	Presser Foot for 17050.....	40
17052	7643	Throat Plate for 17050.....	35
17053	7649	Feed Dog, for stitching on embroidery, for 53-3 Machine.....	40
17054	—	Presser Foot Plate for 17056.....	75
17055	—	“ “ Shank for 17056.....	1 00
17056	7649	Presser Foot (hinged) complete for 17053, Nos. 11833, 17054 and 17055.....	1 75

## NUMERICAL LIST OF PARTS

NO.	PLATE	NAME	EACH
17057	7649	Throat Plate for 17053.....	\$ 45
17058	—	“ “ small needle hole, for 17041.	35
17059	7647	Looper Carrier with two 735c, for 53-3 and 53-4 Machines.....	50
17060	7642	Needle Bar (hollow) with 857H, for 53-1 and 53-3 Machines.....	50
17061	—	Presser Foot Plate for 17031, obsolete....	1 00
17062	—	“ “ Shank for 17031, obsolete....	2 00
Nos. 17063 to 17067 FOR 53-4 MACHINE.			
*17063	—	Arm with 450c, 2006 and 2803.....	4 00
17064	7654	“ Top Cover.....	05
*17065	—	Bed, obsolete.....	6 00
17066	—	“ Slide for 17067.....	25
17067	7657	Bed Slide complete, Nos. 2824, 17066 and two 50216J.....	35
Nos. 17068 to 17073 FOR 17075, OBSOLETE.			
17068	7657	Clamp Arm (lower).....	3 00
17069	7657	“ “ (upper, back) with 10165....	1 25
17070	7657	“ “ (upper, front) with 10165....	1 25
17071	7657	“ Check.....	1 75
17072	7657	“ Cover.....	75
17073	7658	“ Crank Shaft Lever.....	75
17074	7651	“ “ “ “ Stop for 17075 and 17124.....	30
17075	—	Clamp complete for 53-4 Machine, Nos. 1182D, 10170, 10171, 10177 to 10179, 10181, 17068 to 17074, 32519, 50197D, two each 176F, 247F, 397E, 402D, 1053D, 10164, 10172, 10173, 10195 and four 691F, obsolete.....	11 80
Nos. 17076 to 17079 FOR 53-4 MACHINE, OBSOLETE.			
17076	7657	Feed Bar (10 stitches to the inch) with 207D, 1159F, 1550H, 17093 and two 17092.....	6 00
17077	—	Feed Bar (12 stitches to the inch) with 207D, 1159F, 1550H, 17093 and two 17092.....	6 00
17078	—	Feed Bar (14 stitches to the inch) with 207D, 1159F, 1550H, 17093 and two 17092.....	6 00
17079	—	Feed Bar (16 stitches to the inch) with 207D, 1159F, 1550H, 17093 and two 17092.....	6 00
17080	7650	Feed Bar Carrier Block (back) for 17084, obsolete.....	1 00



## NUMERICAL LIST OF PARTS

NO.	PLATE	NAME	EACH
17080	7650	Feed Bar Carrier Block (front) for 17081 and 17132.....	\$1 00
Nos. 17081 TO 17083 FOR 17084 AND 17132.			
17081	7650	Feed Bar Carrier Cap (lower, back).....	25
17081	7650	" " " " (lower, front).....	25
17082	7650	" " " " (upper, left).....	75
17083	7650	" " " " (upper, right).....	75
17084	—	Feed Bar Carrier complete for 53-4 Machine, Nos. 17082, 17083, 17085, two each 219D, 17080, 17081 and twelve 207D, obsolete.....	5 00
17085	7650	Feed Bar Carrier Connection with 1824, for 17084 and 17132.....	75
Nos. 17086 TO 17113 FOR 53-4 MACHINE.			
17086	7650	Feed Bar Carrier Lever.....	2 00
17087	7653	" " " " Lock Stud.....	20
17088	7653	" " " " " " Bracket.....	80
17089	7653	" " " " " " Plate.....	75
17090	7653	" " " " Stop.....	1 50
17091	7658	" " Friction Spring, obsolete.....	25
17092	7653	" " Pin for 17076 to 17079 and 17125 to 17129.....	01
17093	7658	Feed Bar Stop Screw Bracket for 17076 to 17079, obsolete.....	40
17094	7653	Feed Pawl (left).....	1 50
17095	7653	" " (right) with 10165.....	1 25
17096	7658	" " Carrier with 32519 and two 50198E, obsolete.....	1 00
17097	7653	Feed Pawl Carrier Hinge Pin.....	15
17098	7658	" " " Stop, obsolete.....	40
17099	7658	" " Disengaging Slide, obsolete.....	75
17100	7658	" " Plate, obsolete.....	25
17101	7653	" " Spring.....	02
17102	7654	Needle Bar for 17103.....	50
17103	—	Needle Bar complete, Nos. 2273, 7649, 7651, 17102, 17104 and 17105.....	1 25
17104	7654	Needle Bar Yielding Presser for 17103.....	50
17105	7654	" " " " Spring Stop for 17103.....	10
17106	7658	Needle Plate, large needle hole, obsolete.....	1 00
17107	—	" " small needle hole, obsolete.....	1 00
17108	7658	Thread Controller with 17109, for 17110, obsolete.....	50
17109	7654	Thread Controller Spring for 17108 and 17141.....	05

## NUMERICAL LIST OF PARTS

NO.	PLATE	NAME	EACH
17110	—	Thread Controller complete, Nos. 767D, 17108 and 17111, obsolete.....	\$1 00
17111	7658	Thread Controller Thread Guide for 17110, obsolete.....	50
17112	7659	Bed Frame with 970D, two each 7263, 14008 and four each 11118 and wood screws 1¼ in. No. 10.....	1 25
*17113	—	Bed.....	6 00
Nos. 17114 TO 17116 FOR 17124.			
17114	7650	Clamp Arm (lower).....	3 00
17115	7650	" " (upper, back) with 10165.....	1 25
17116	7650	" " (upper, front) with 10165.....	1 25
17117	7650	" Check Section (left) for 17119.....	1 25
17117	7650	" " " (right) for 17119.....	1 25
17118	7651	" " " Hinge Block for 17119.....	50
Nos. 17119 TO 17123 FOR 17124.			
17119	7650	Clamp Check complete, Nos. two each 17117, 17118 and four 2653.....	3 50
17120	7651	Clamp Check Spring.....	05
17121	7652	" Cover.....	75
17122	7651	" Crank Shaft Lever with 50169D.....	75
17123	7651	" Wire Guard.....	20
Nos. 17124 TO 17150 FOR 53-4 MACHINE.			
17124	—	Clamp complete, Nos. 1182D, 10170, 10171, 10177 to 10179, 10181, 17074, 17114 to 17116, 17119, 17121 to 17123, 32519, 50197D, two each 176F, 247F, 397E, 401D, 1053D, 10164, 10172, 10173, 10195, 17120 and four 691E.....	14 15
17125	—	Feed Bar (10 stitches to the inch) with 152F, 402D, 1550H, 17136 and two 17092.....	6 00
17126	—	Feed Bar (12 stitches to the inch) with 152F, 402D, 1550H, 17136 and two 17092.....	6 00
17127	7652	Feed Bar (14 stitches to the inch) with 152F, 402D, 1550H, 17136 and two 17092.....	6 00
17128	—	Feed Bar (16 stitches to the inch) with 152F, 402D, 1550H, 17136 and two 17092.....	6 00
17129	—	Feed Bar (18 stitches to the inch) with 152F, 402D, 1550H, 17136 and two 17092.....	6 00
17130	7650	Feed Bar Carrier Block (back) for 17132.....	1 00

## NUMERICAL LIST OF PARTS

NO.	PLATE	NAME	EACH
17131	7650	Feed Bar Carrier Block (back) Extension for 17132.....	\$ 20
17132	—	Feed Bar Carrier complete, Nos. 402D, 17080, 17082, 17083, 17085, 17130, 17131, two each 219D, 17081 and twelve 207D.....	5 00
17133	7650	Feed Bar Friction Spring.....	50
17134	7653	" " " " Hook with 17135.....	30
17135	7653	" " " " Stud for 17134.....	05
17136	7653	Feed Bar Stop Screw Bracket for 17125 to 17129.....	40
17137	7653	Feed Pawl Carrier with 32519 and two 50198E.....	1 25
17138	7653	Feed Pawl Disengaging Lever.....	75
17139	7654	" " Plate.....	25
17140	7654	Needle Plate.....	1 00
17141	7654	Thread Controller Post with 17109, for 17142.....	50
17142	—	Thread Controller complete, Nos. 767D, 17141 and 17143.....	1 00
17143	7654	Thread Controller Thread Guide for 17142.....	50
17144	7654	" Take-up Plate.....	25
17145	7660	Drip Pan for 17112.....	25
17146	7659	Chain, length 5 in., with 10242, for 17148.....	05
17147	7659	Rock Shaft Lifting Bracket Hook for 17148.....	15
17148	7659	Rock Shaft complete, Nos. 2764, 6336, 6337, 7124, 16128, 17146, 17147 and two 2770.....	1 30
17149	7652	Feed Bar Cover.....	2 00
17150	7658	" " Spring, obsolete.....	25
17153	7644	Thread Nipper Cam with two 1147C, for 53-1 to 53-3 Machines.....	50
Nos. 17154 TO 17160 FOR 53-2 MACHINE.			
17154	7646	Feed Dog.....	30
17155	7648	Knife Bar with 2301, for 17156.....	1 50
17156	—	Knife Bar complete, Nos. 621D, 2298, 2299, 2648, 17155, 17157 and two 335H.....	4 85
17157	7647	Knife Holder with 620C and two 335H, for 17156.....	1 00
17158	—	No. cancelled, order 17027.....	
17159	7645	Presser Bar.....	30
17160	7646	" Foot for 17154.....	1 00
Nos. 17161 TO 17163 FOR 17164.			
17161	—	Throat Plate Body.....	1 25

## NUMERICAL LIST OF PARTS

NO.	PLATE	NAME	EACH
17162	7646	Throat Plate Cutting Bar.....	\$1 00
17163	7646	" " Slide.....	50
17164	7646	Throat Plate complete for 17154, Nos. 236E, 17161 to 17163 and two 578D.....	2 75
17165	7662	Feed Dog, for laying braided stitching around air tucks on glove work, for 53-1 Machine.....	30
Nos. 17166 TO 17168 FOR 17165.			
17166	7662	Looper Carrier with 211C and 735C.....	50
17167	7662	Presser Foot.....	1 00
17168	7662	Throat Plate.....	1 00
22003	7657	Wrench for 1550 (Accessories).....	05
25200	7648	" " 1527 (Accessories).....	10
25527	7640	Guide for 53-1 to 53-3 Machines.....	10
26026	5901	Screw Driver, large (Accessories).....	10
26485	5901	" " small (Accessories).....	05
27323	1105	Knife Grinder Knife Holder Guide Bar for 27661.....	05
27442	5975	Thread Unwinder Spool Rest with 27702, for 27449 and 41807.....	10
27443	5975	Thread Unwinder Spool Weight with 27444 and 27445, for 27449.....	25
27444	7644	Thread Unwinder Spool Weight Centre for 27443.....	10
27445	5975	Thread Unwinder Spool Weight Thread Guide for 27443.....	05
27446	5975	Thread Unwinder Thread Eyelet Wire for 27448.....	05
27447	5975	Thread Unwinder Thread Eyelet Rod for 27448.....	15
27448	—	Thread Unwinder Thread Eyelet complete for 27449 and 41807, Nos. 27446 and 27447.....	20
27449	5975	Thread Unwinder complete, for one small spool, for 53-1 to 53-3 Machines, Nos. 27442, 27443, 27448 and two wood screws 3/4 in. No. 10.....	50
27564	1104	Knife Grinder Frame with 27574, for 27661.....	75
27565	1104	Knife Grinder Emery Wheel, 2 in. diam., for 27661.....	25
Nos. 27567 TO 27569 FOR 27661.			
27567	1105	Knife Grinder Emery Wheel Shaft.....	1 00
27568	1105	" " " " " O I I Hole Cover (rubber).....	01
27569	1105	Knife Grinder Emery Wheel Shaft Pulley.....	30

## NUMERICAL LIST OF PARTS

NO.	PLATE	NAME	EACH
27572	1104	Knife Grinder Knife Holder Guide Bar Bracket with 27574, for 27661.....	\$ 30
27573	1105	Knife Grinder Knife Holder Guide Bar Bracket Spring for 27661.....	05
27574	1105	Knife Grinder Knife Holder Guide Bar Bracket Spring Hook for 27564 and 27572.....	02
27657	—	Knife Grinder Knife Holder Body for 27658.....	25
27658	1105	Knife Grinder Knife Holder complete for 27661, Nos. 899D, 27657 and 27660....	35
27659	1105	Knife Grinder Knife Holder Stop Collar with 237F, for 27661.....	10
27660	7647	Knife Grinder Knife Position Pin for 27658.....	01
27661	—	Knife Grinder complete for 5726 for 53-2 Machine, Nos. 261D, 1508C, 27323, 27564, 27565, 27567, 27569, 27572, 27573, 27658, 27659, 27662, 27822, two 27568, three wood screws 1 in. No. 10 and four each 310F and 1516D.....	4 00
27662	1104	Wrench for 1508 and 1516 for 27661.....	15
27702	5975	Thread Unwinder Spool Pin for 27442....	05
27822	1105	Knife Grinder Emery Wheel Clamping Nut Washer for 27661.....	10
29907	7653	Feed Bar Carrier Lever Handle (wood) for 53-4 Machine.....	02
32519	7651	Clamp Crank Shaft Lever Stop Pin for 17075 and 17124.....	01
32519	7651	Feed Pawl (left) Stop Pin for 17096 and 17137.....	01
35143	7645	Tweezers, 4 in. (Accessories).....	10
36569	5901	Oiler with 36571, for 36570.....	05
36570	—	" 36569, filled with oil (Accessories)...	08
36571	5901	" Spout, 1 3/4 in. long, with 36807, for 36569.....	01
36807	7647	Oiler Spout Washer (leather) for 36571...	01
41400	7645	Machine Rest Pin (wood) 3 1/8 in. long (Accessories).....	04
41401	7645	Machine Rest Pin (wood) 5 1/8 in. long (Accessories).....	06
41541	7661	Thread Unwinder Thread Guide with 41542, for 41807.....	25
41542	7651	Thread Unwinder Thread Guide Centre Pin for 41541.....	05
41546	7658	Thread Unwinder Spool Weight Centre Pin for 41547.....	05

## NUMERICAL LIST OF PARTS

NO.	PLATE	NAME	EACH
41547	7661	Thread Unwinder Spool Weight complete for 41807, Nos. 10243 and 41546.....	\$ 07
41807	7661	Thread Unwinder complete, for one small spool, for 53-4 Machine, Nos. 27442, 27448, 41541, 41547 and two wood screws 3/4 in. No. 10.....	60
44139	1508	Machine Hinge Plate for 44140.....	15
44140	—	Machine Hinge complete, Nos. 12361, 44139 and wood screw 1 1/4 in. No. 14 (Accessories).....	30
50089B	7653	Feed Bar Carrier Lever Handle Screw for 53-4 Machine.....	10
50169D	7651	Clamp Wire Guard Set Screw for 17122....	02
50197D	7651	" Crank Shaft Stop Screw for 17075 and 17124.....	03
50198E	7653	Feed Pawl (left) Hinge Stud for 17096 and 17137.....	03
50198E	7653	Feed Pawl (right) Hinge Stud for 17096 and 17137.....	03
50216J	7654	Bed Slide Spring Screw for 17067.....	02
52016	1506	Presser Bar Lifter for 53-1 to 53-3 Machines.....	20

**ILLUSTRATIONS OF PARTS**  
**FOR**  
**MACHINES Nos. 53-1 to 53-4**

PLATE 1104—ONE-HALF SIZE

27564

27662

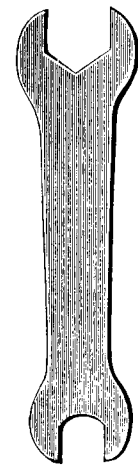
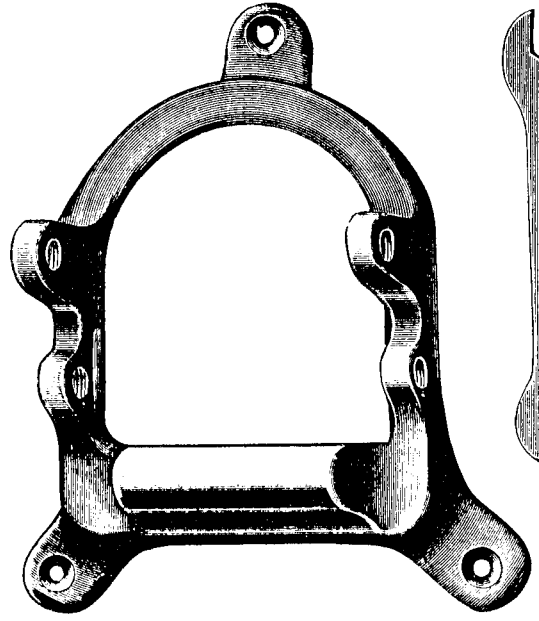

27572

27565

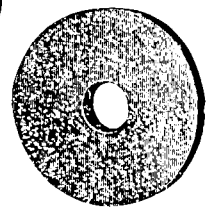
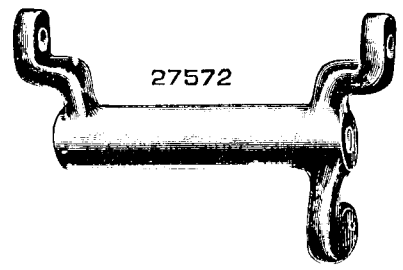

PLATE 1105—FULL SIZE

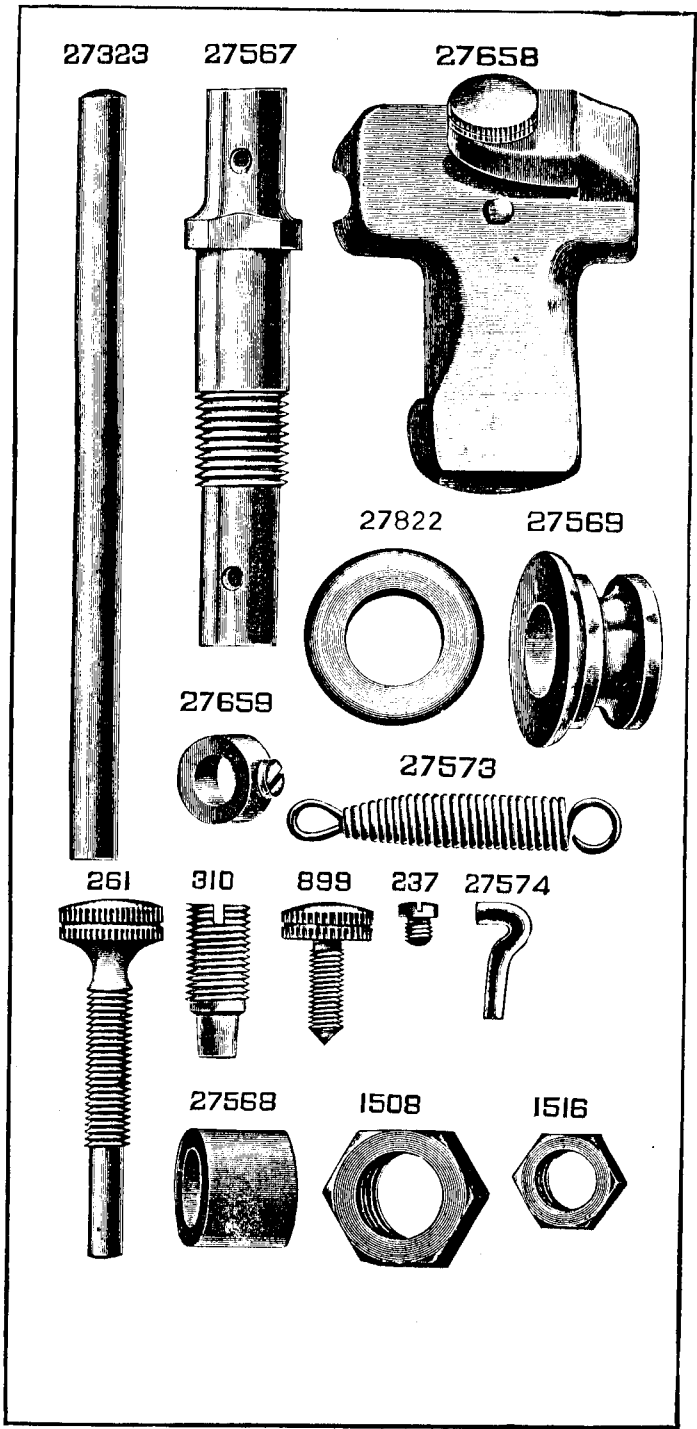

PLATE 1500—ONE-HALF SIZE

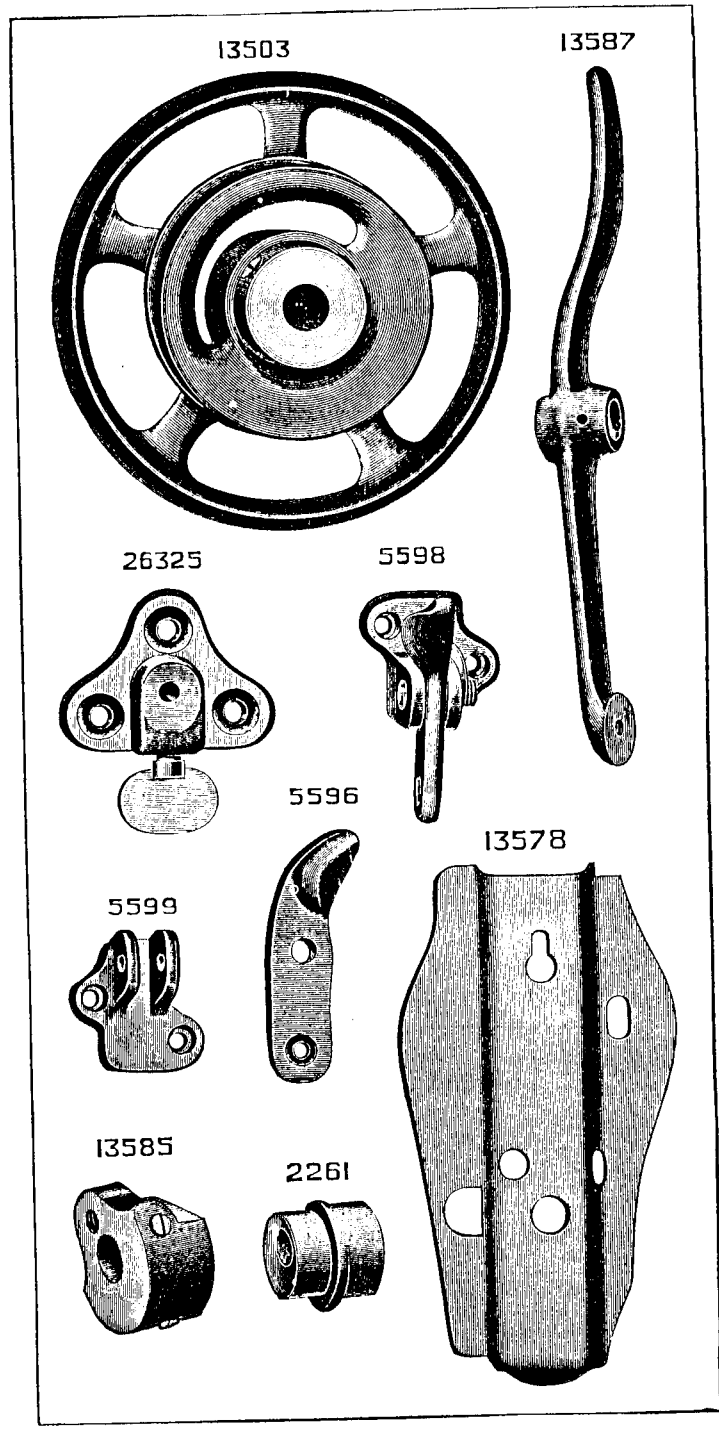

PLATE 1506—FULL SIZE

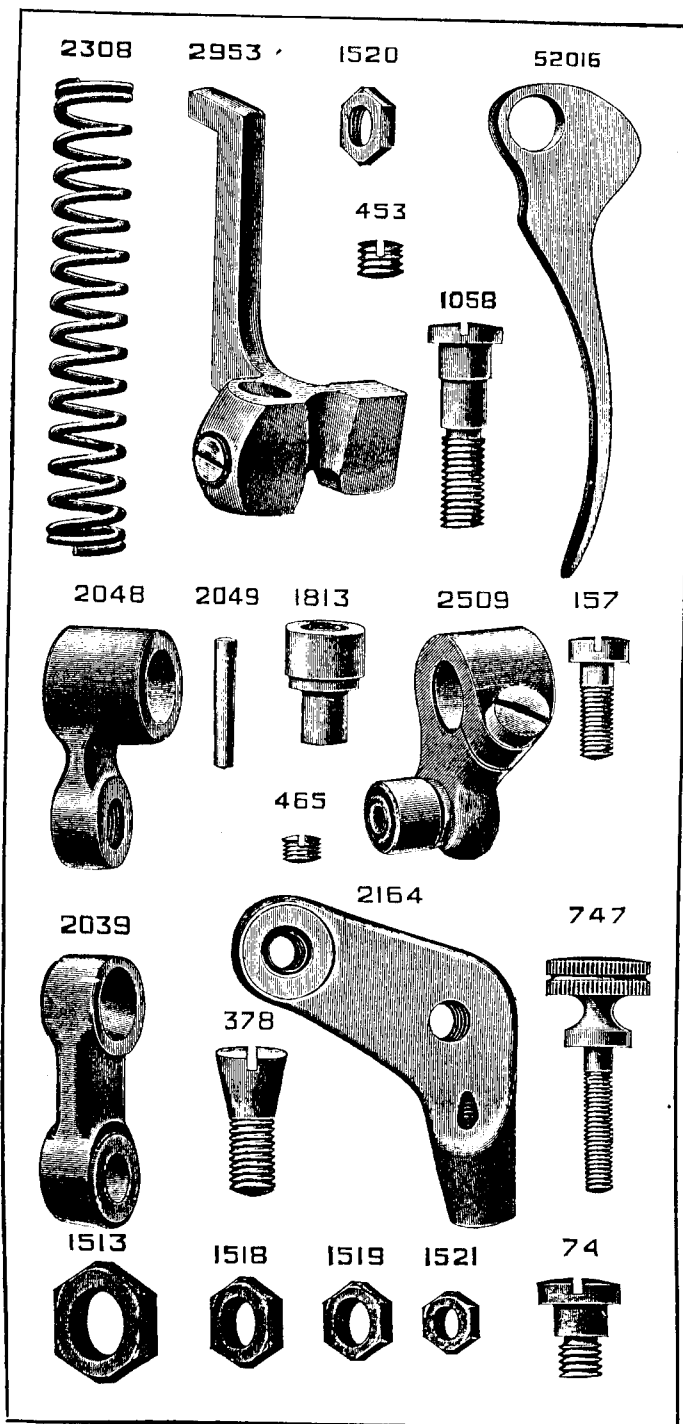

PLATE 1507—FULL SIZE

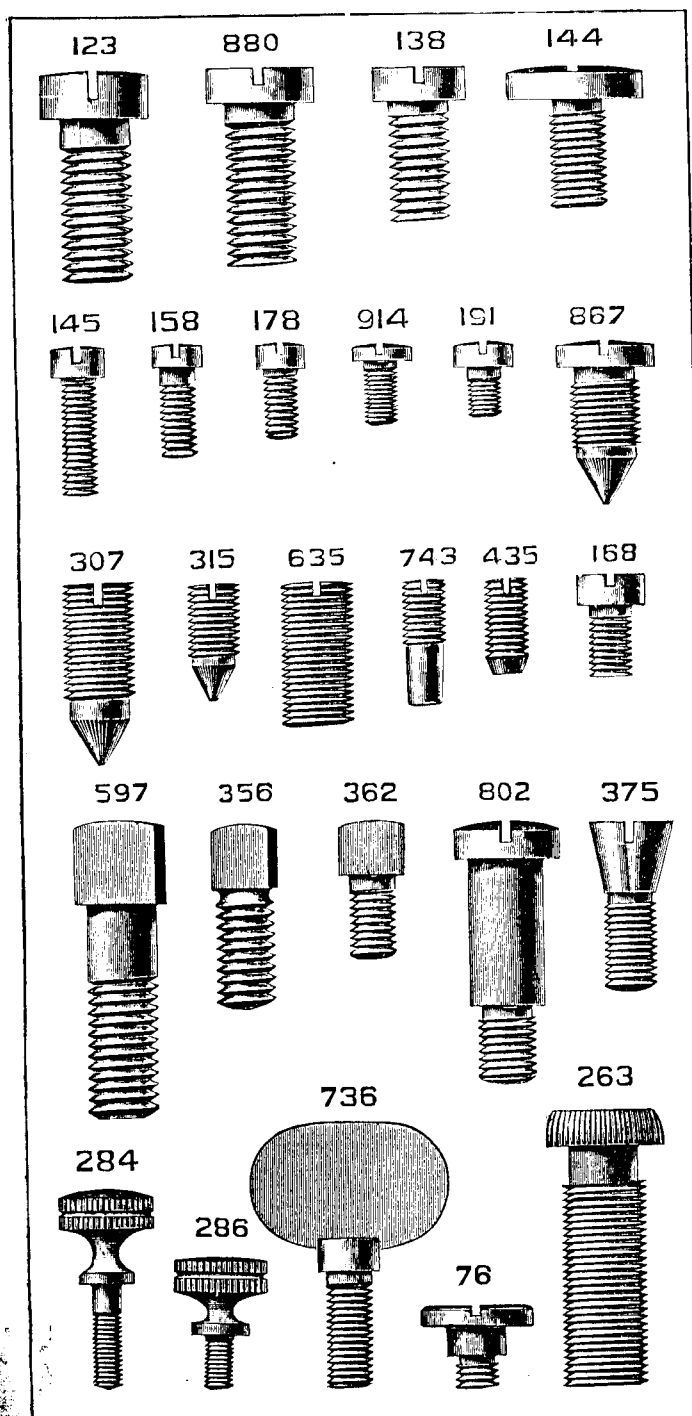

PLATE 1508—FULL SIZE

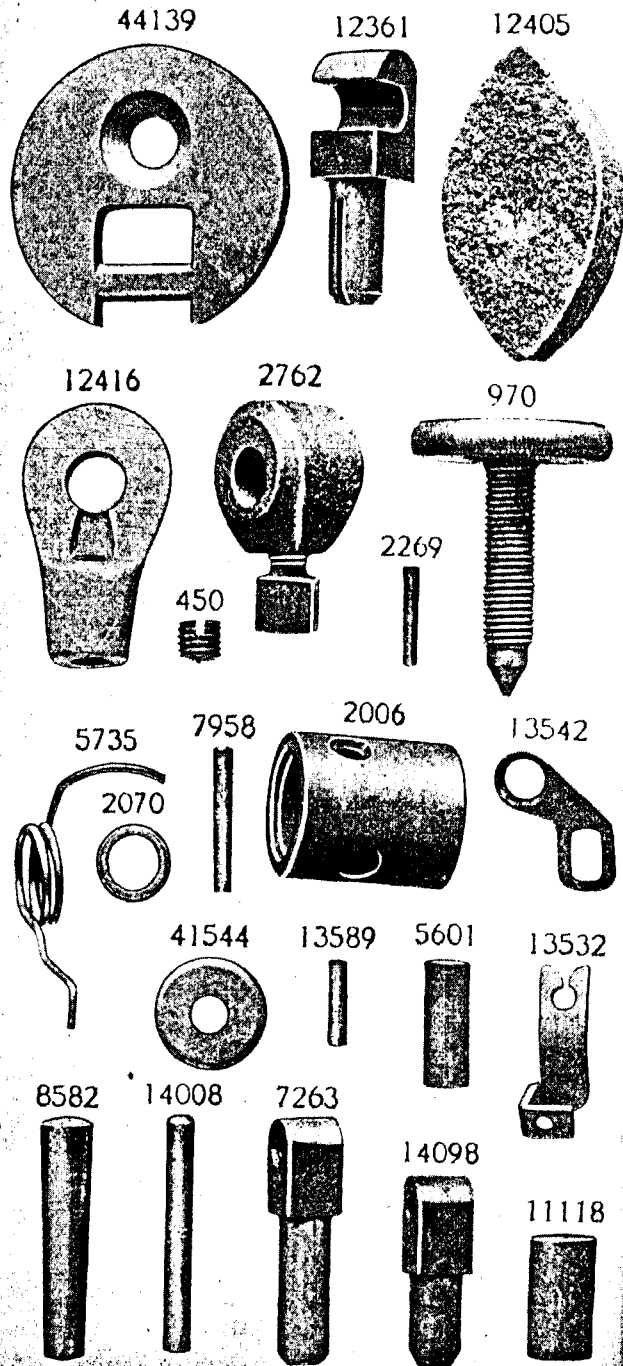

PLATE 1511—ONE-FOURTH SIZE

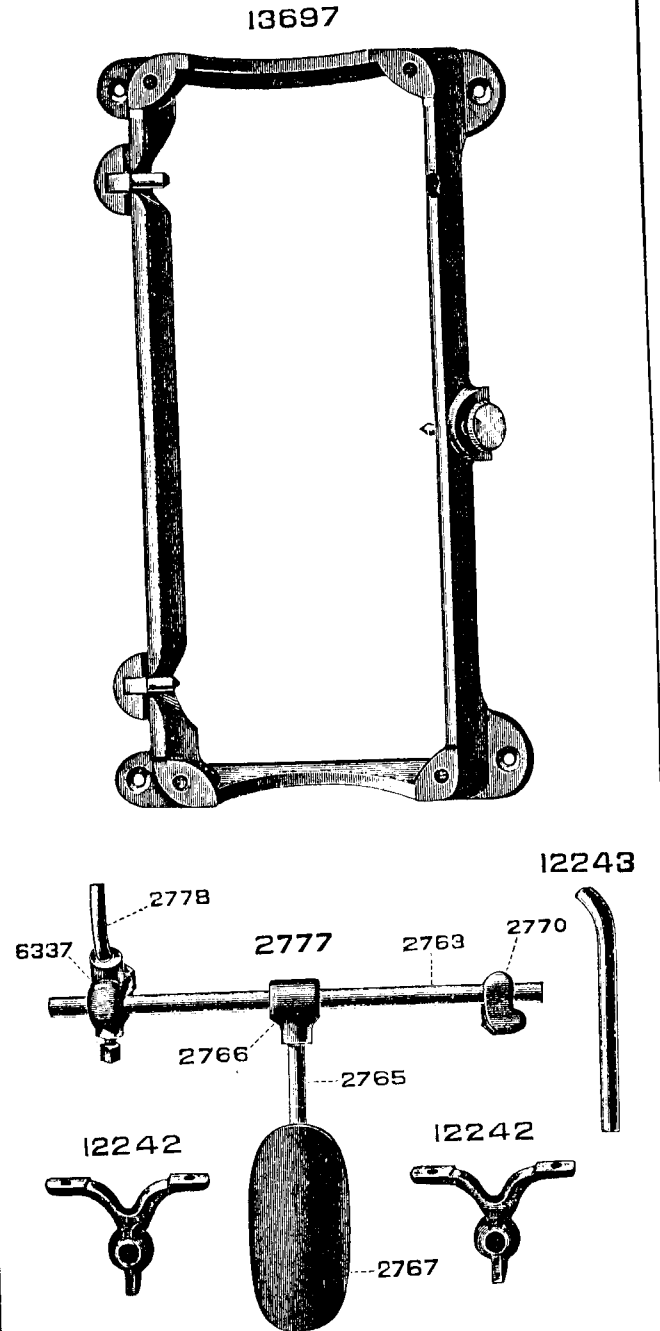
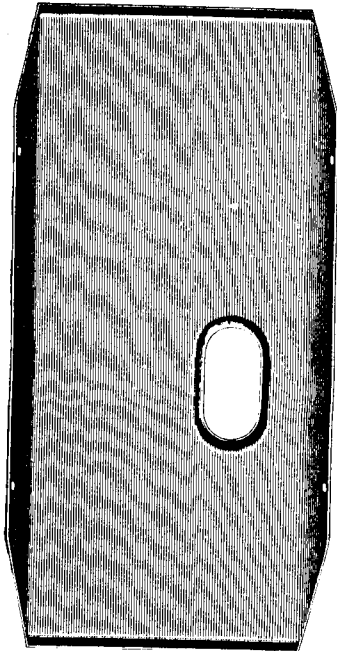



PLATE 1514—ONE-FOURTH SIZE

13635



2978

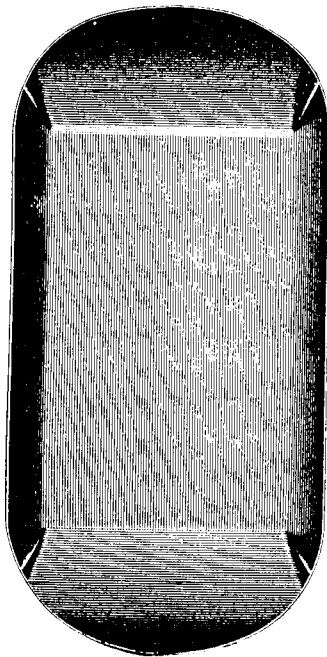
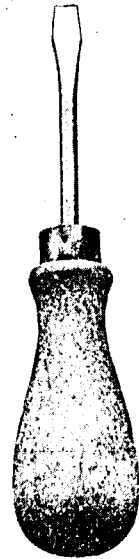

PLATE 5901—ONE-HALF SIZE

26026



26485



8909



8908



36569

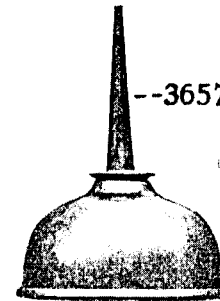

--36571

PLATE 5975—ONE-HALF SIZE

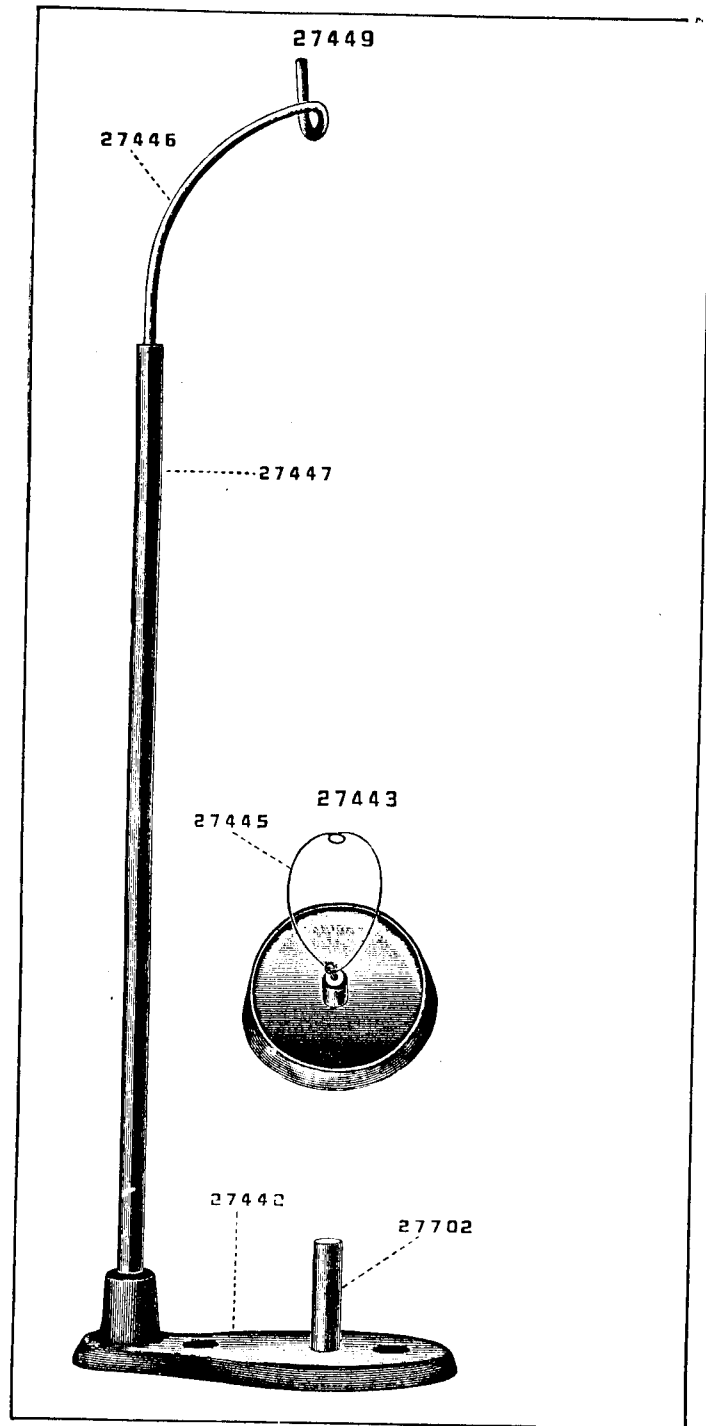

PLATE 7640—FULL SIZE

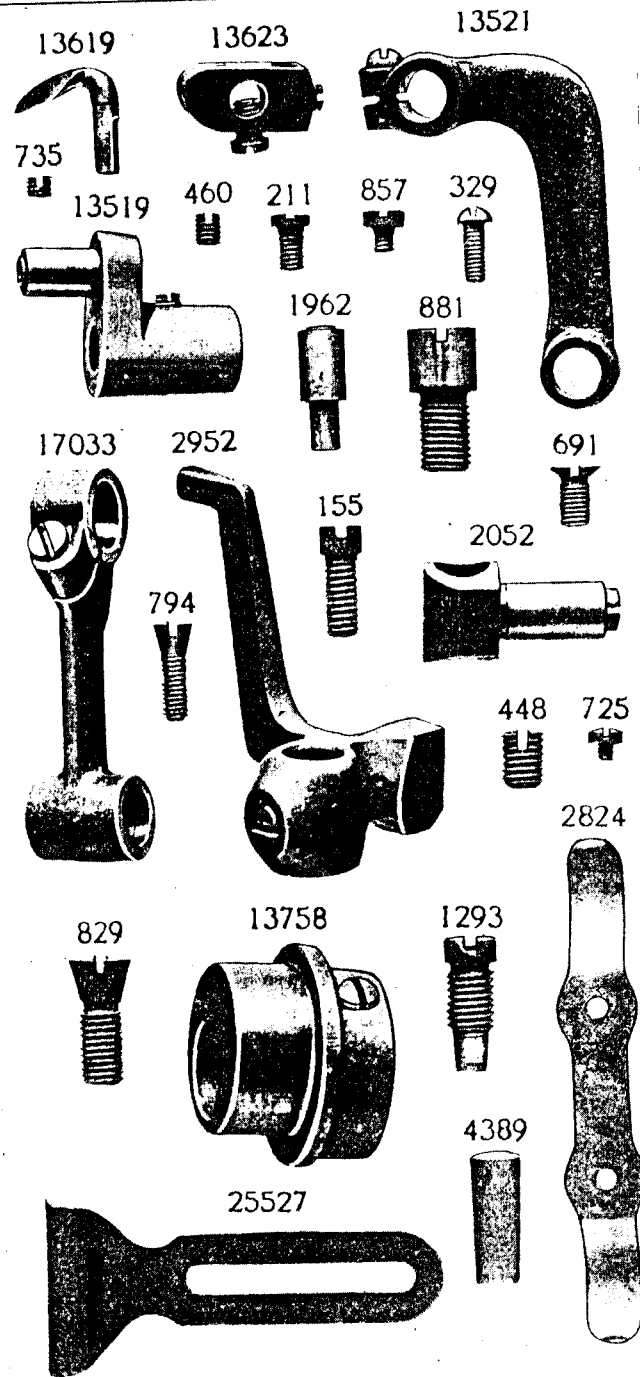

PLATE 7641—ONE-HALF SIZE

13502



2047



13508

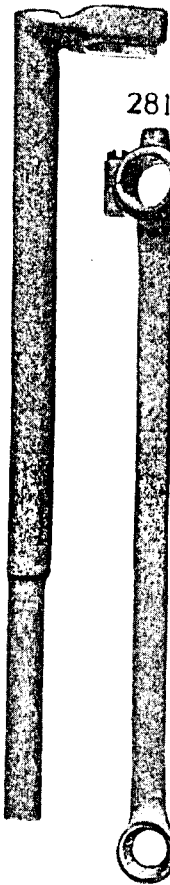

2811



2042

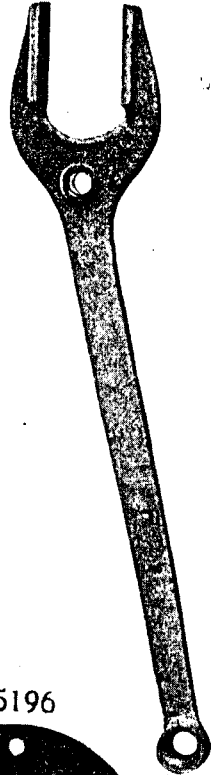

2037

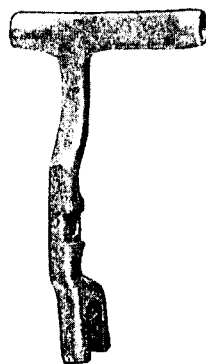

15196

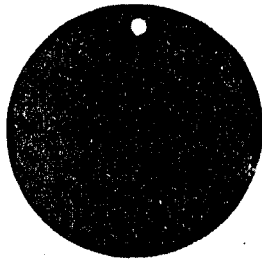

PLATE 7642—ONE-HALF SIZE

17004



17060



2058



3052



17043

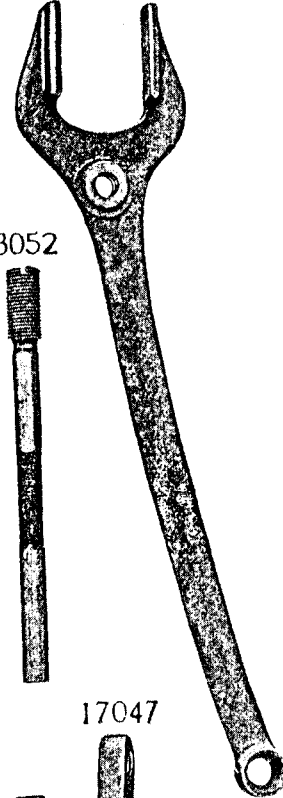

13526

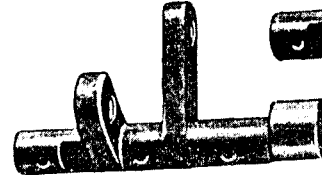

17047

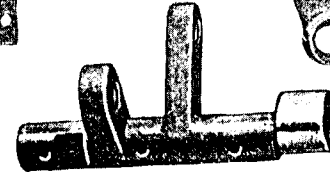

17040

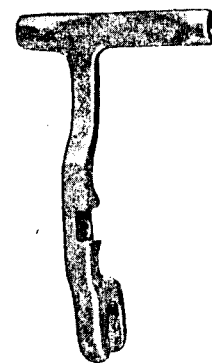

17012

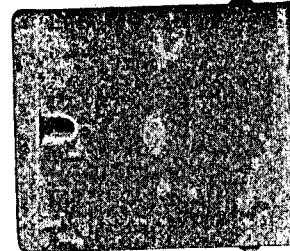
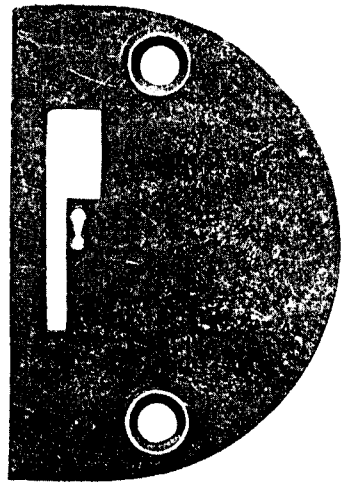

PLATE 7643—FULL SIZE

17003



17010



17006



17050



17052

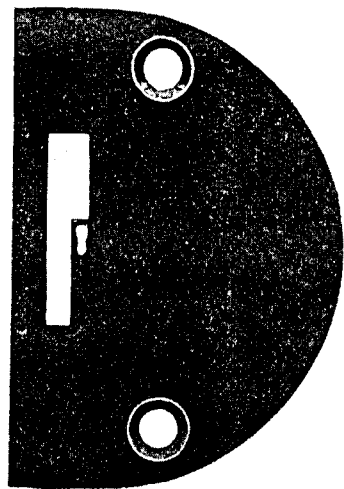

17051



PLATE 7644—FULL SIZE

2102

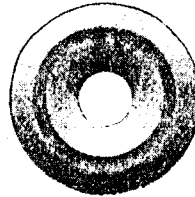

828



17007

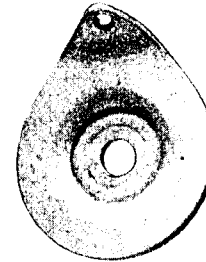

27444



1560



8238



17008

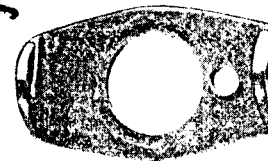

13530



17153

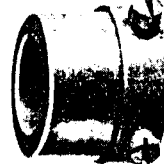

1147



2921

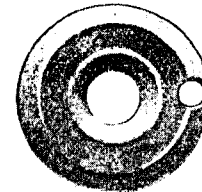

17034



13533



12162



190



1609

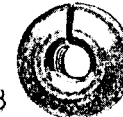

13559

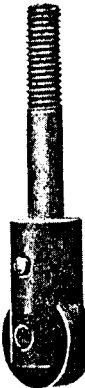

13539



13538



17037

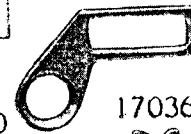

1527



13540



17036



2026



767



219



861



PLATE 7645—ONE-HALF SIZE

17038



17159



17027



17014

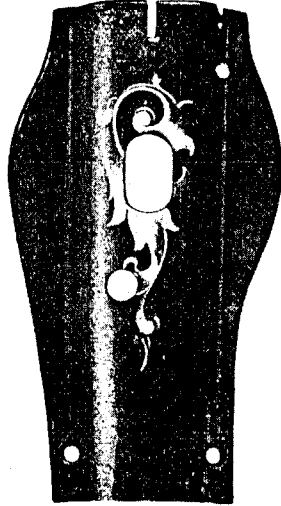

17028



41401



13588



35143



41400

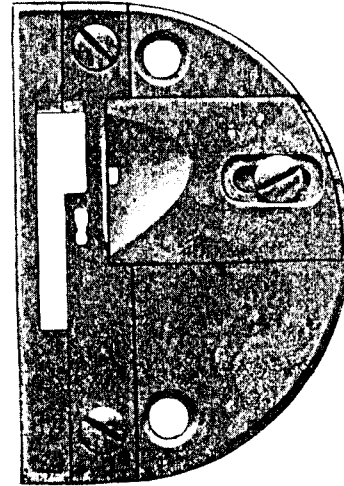

PLATE 7646—FULL SIZE

17162



17164



17154



17160



236



17163

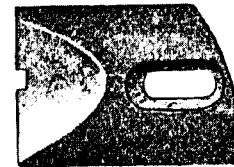

578



PLATE 7647—FULL SIZE

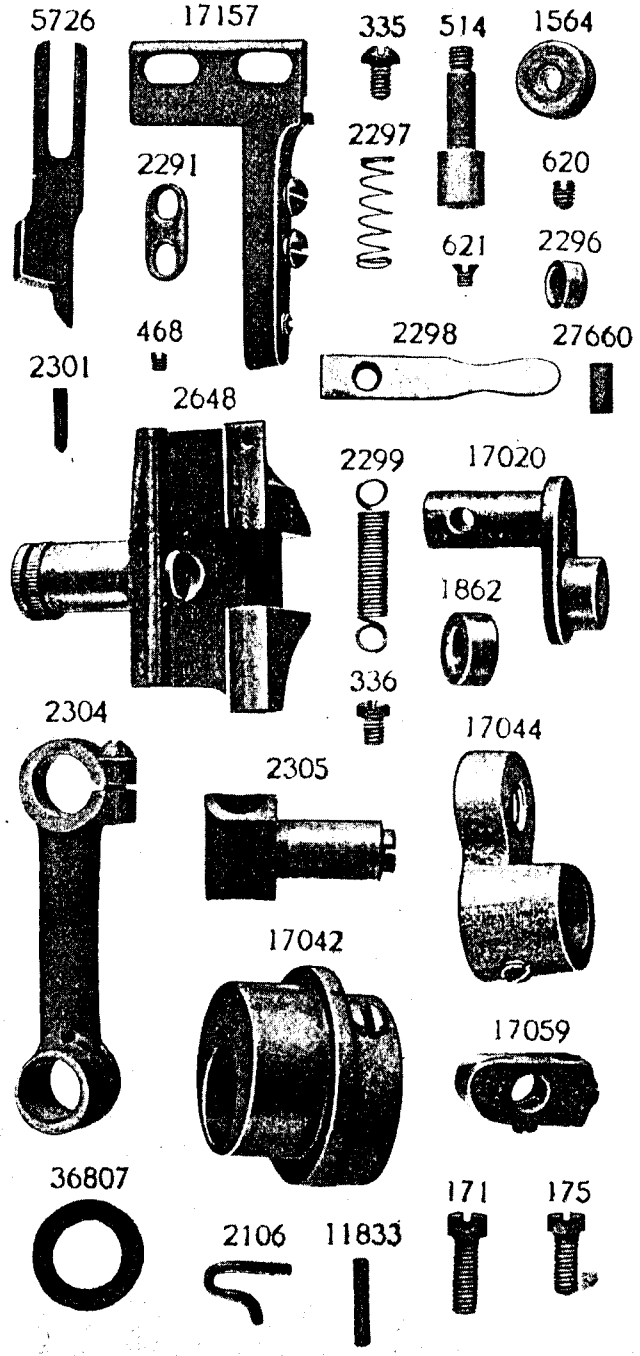

PLATE 7648—ONE-HALF SIZE

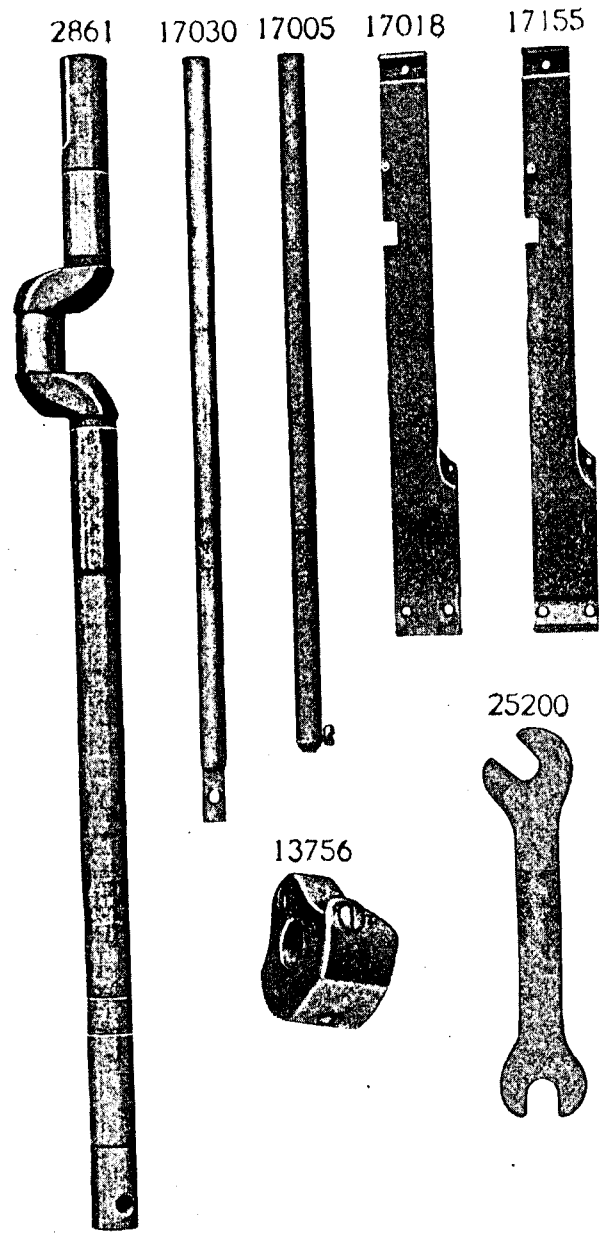
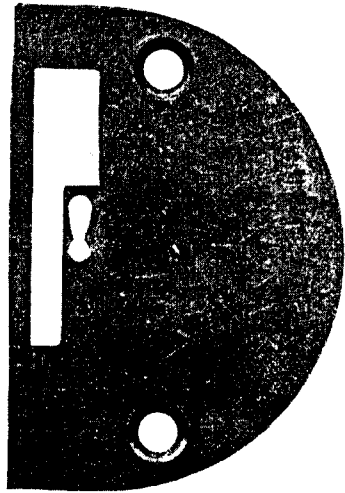

PLATE 7649—FULL SIZE

17041



17049



17048



17053



17057

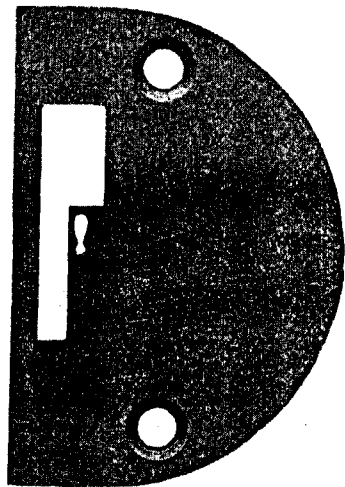

17056

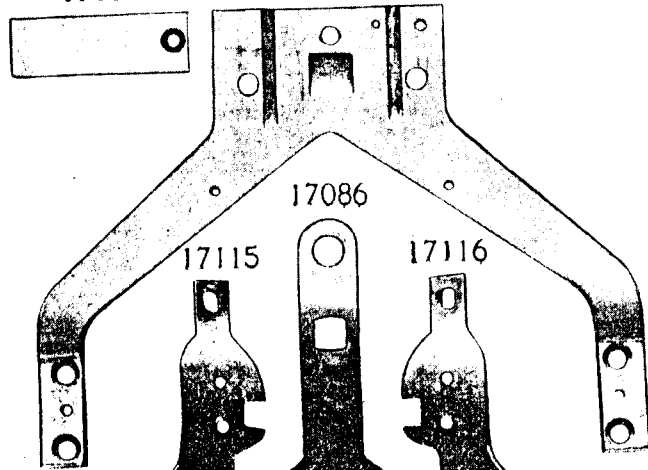

PLATE 7650—ONE-HALF SIZE

17131



17114



17086

17115

17116

17133

17130

17085

17080

17081

17119

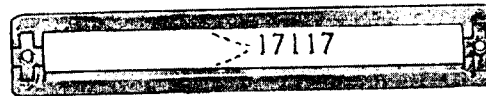

17083



17082

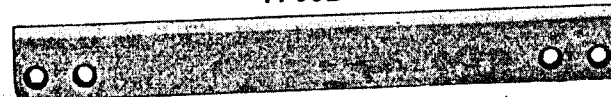

PLATE 7651—FULL SIZE

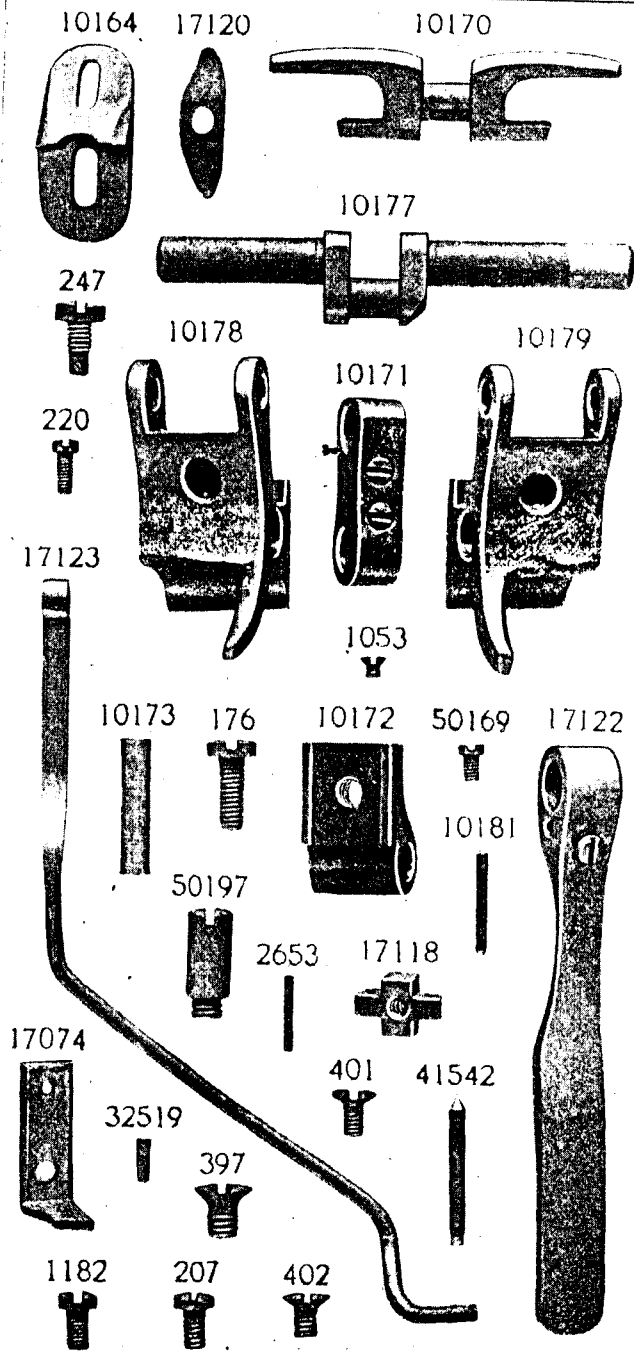

PLATE 7652—ONE-HALF SIZE

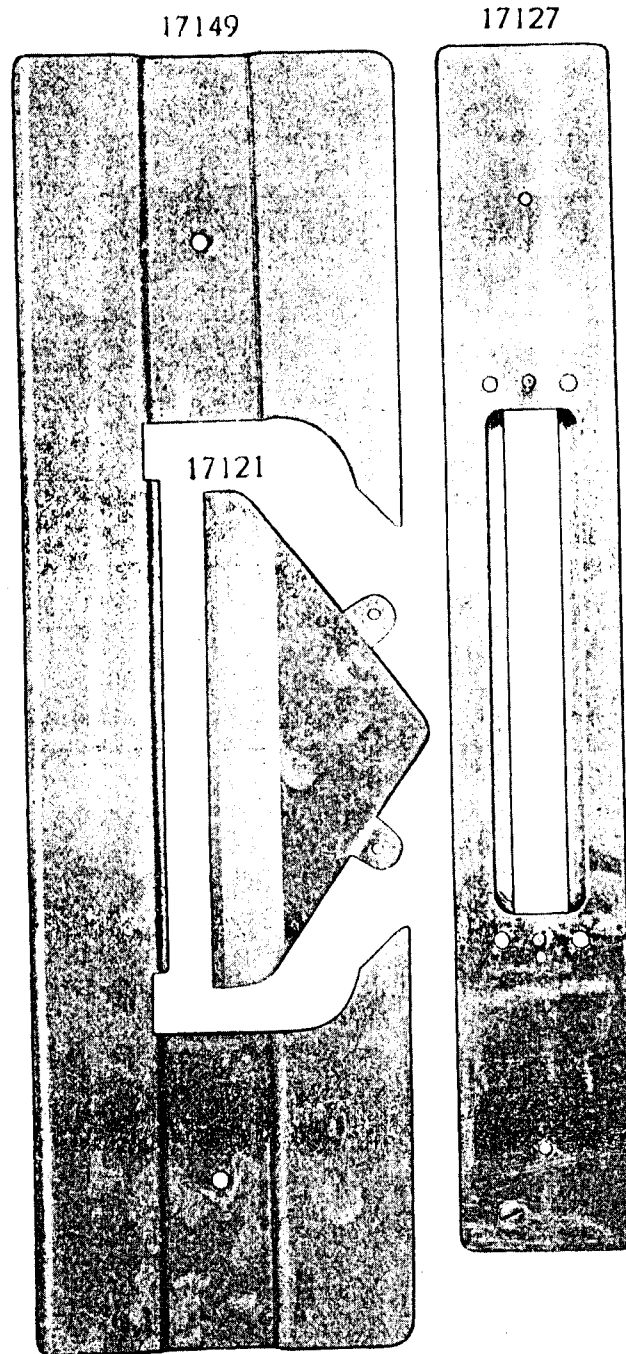



PLATE 7653—FULL SIZE

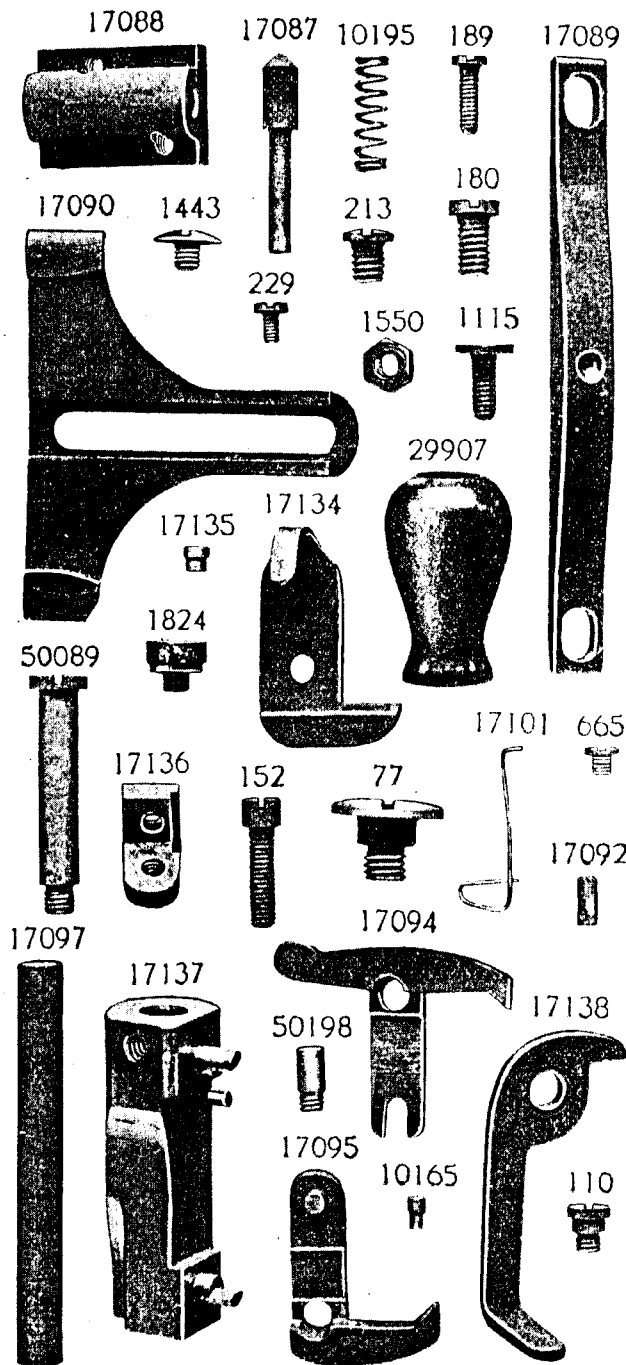

PLATE 7654—FULL SIZE

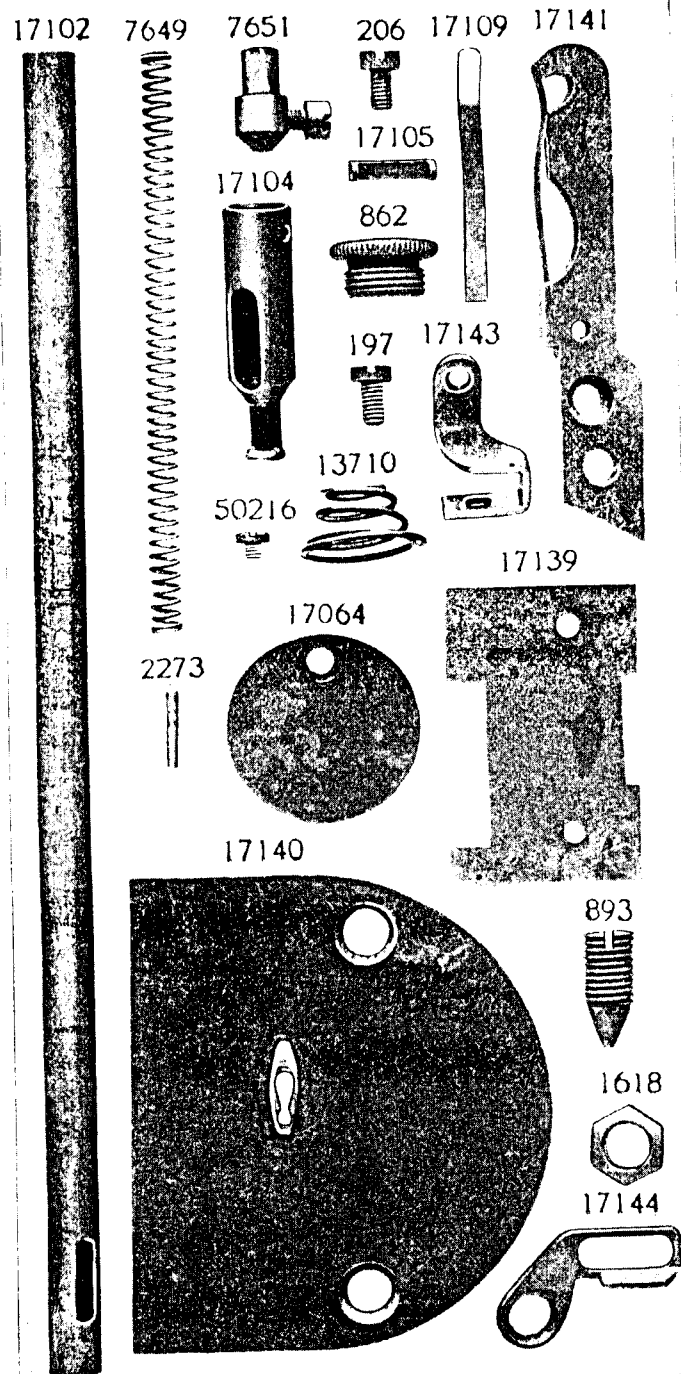

PLATE 7655—FULL SIZE

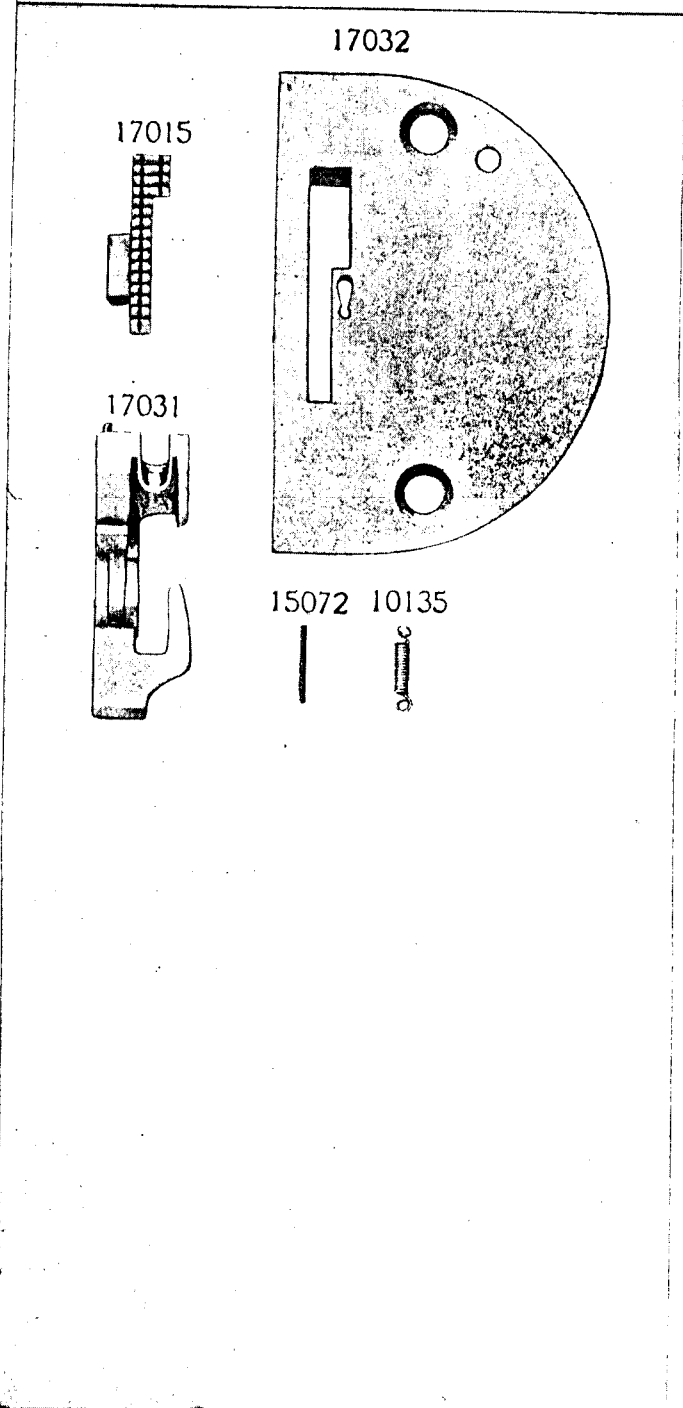

PLATE 7656—FULL SIZE

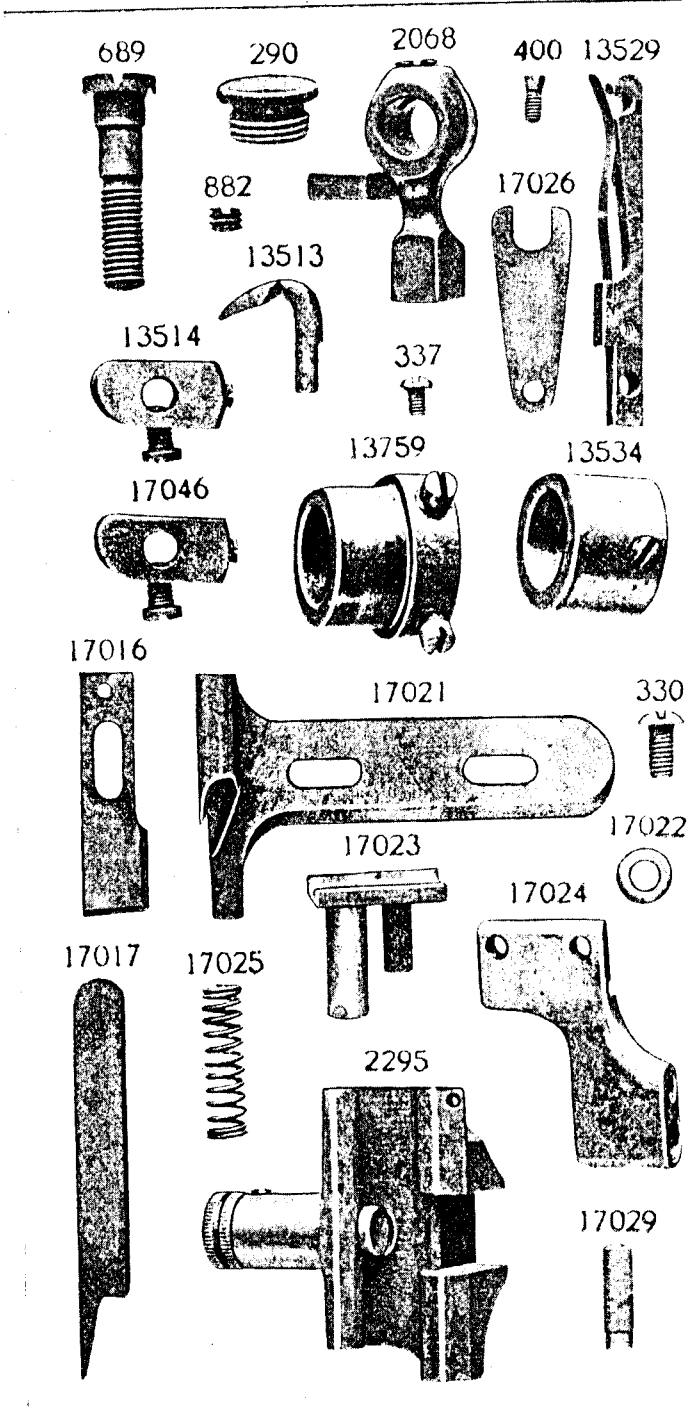

PLATE 7657—ONE-HALF SIZE

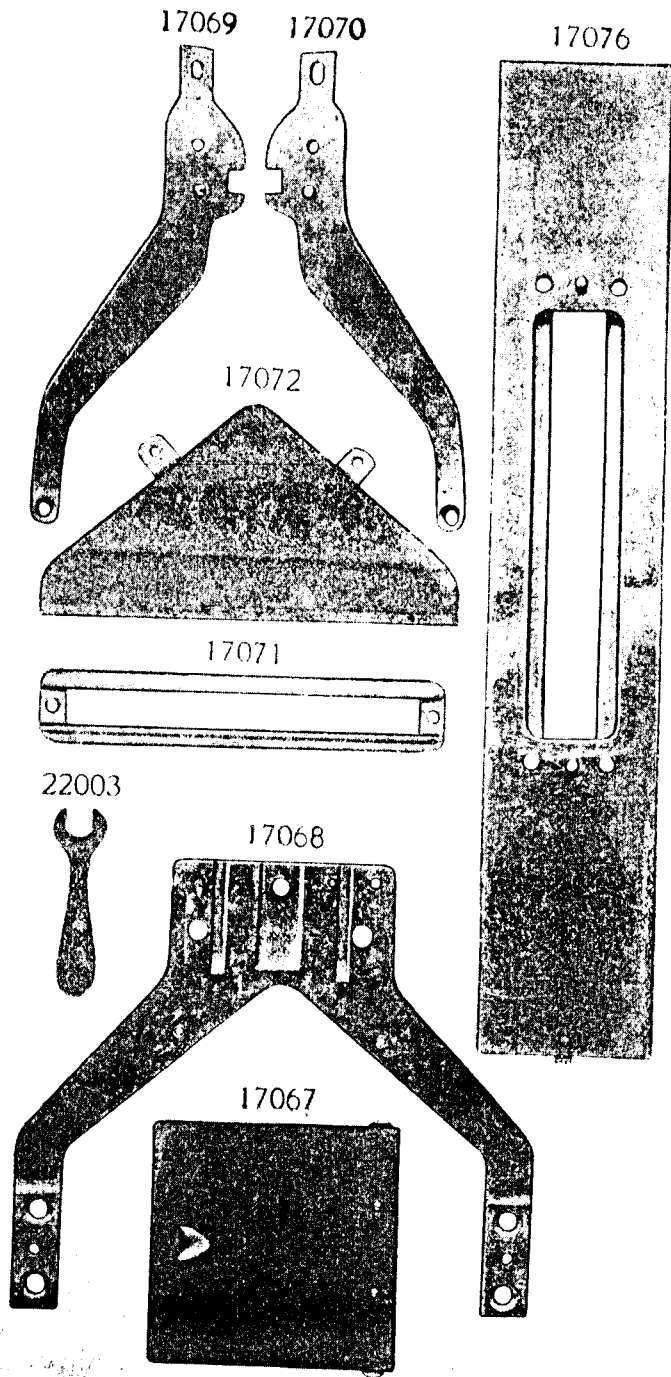

PLATE 7658—FULL SIZE

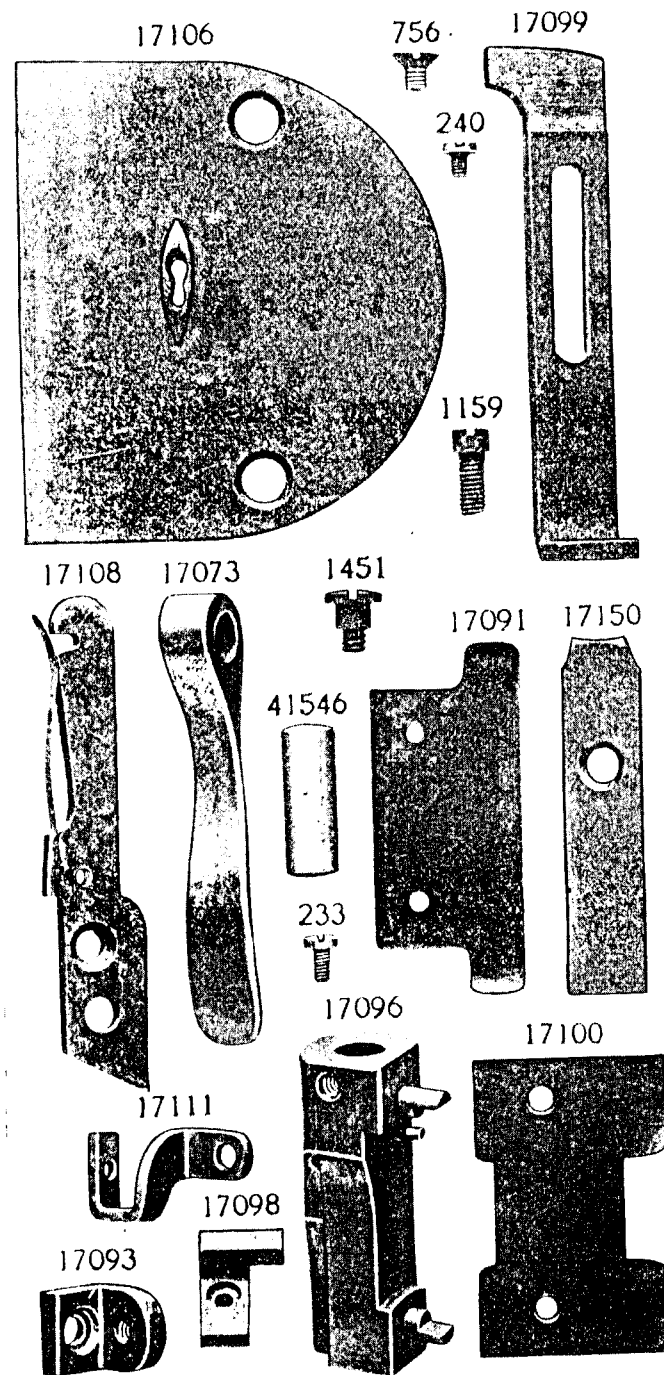
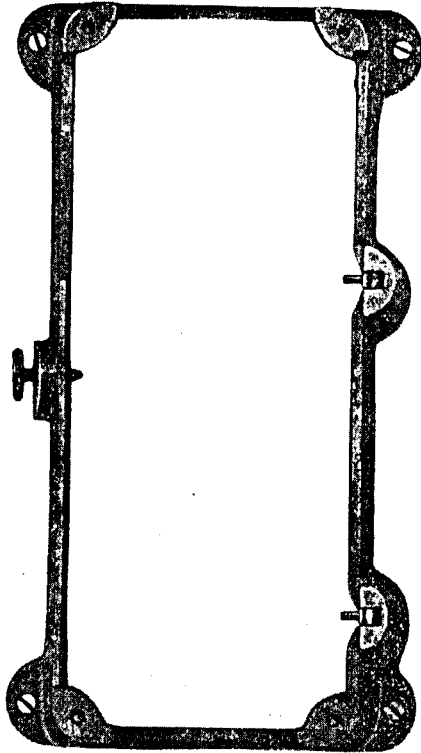

PLATE 7659—ONE-FOURTH SIZE

17112



17146



10242



17148

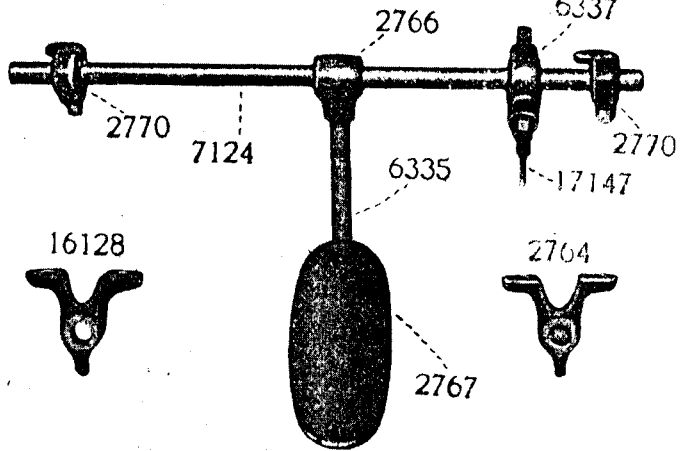

PLATE 7660—ONE-FOURTH SIZE

17145

