

Singer 68-35

Form 8870 Revised
January, 1930
PRINTED IN U. S. A.

LIST
OF
PARTS



MACHINE No. 68-35

THE SINGER MANUFACTURING COMPANY

COPYRIGHT, U. S. A.,
1916, 1918, 1921, 1922, 1926, 1929 AND 1930
BY THE SINGER MANUFACTURING CO.
ALL RIGHTS RESERVED FOR ALL COUNTRIES

INDEX

	PAGE
ATTACHMENTS AND ACCESSORIES.....	21
BOBBIN WINDER.....	21
IRON BASE.....	21
KNIFE GRINDER.....	22
MACHINE NO. 68-35.....	7
NUMERICAL LIST OF PARTS.....	31
OBSOLETE PARTS.....	28
STANDS.....	23
STARTING LEVER AND FOOT LIFTER PARTS.....	26
" " ROCK SHAFT.....	26
TABLE BELT GUIDE.....	27
TAPE HOLDER.....	27
THREAD UNWINDER.....	27

INSTRUCTIONS FOR ORDERING

In ordering from this list, use **ONLY** the part NUMBER in the **FIRST** column.

The number stamped on a Sewing Machine part is in every case the number of the single part only.

Every combination of parts sent out as such has its specific number, which, although not stamped on the parts, must be used when ordering the combination.

Each number always indicates the **SAME PART** in whatever list it appears, or for whatever machine.

The letters after some of the numbers indicate the style of finish only, as follows:

- A—Hardened, Polished, Nickel Plated and Buffed
- B—Polished, Nickel Plated and Buffed
- C—Hardened Only
- D—Polished Only
- E—Soft, Not Polished
- F—Hardened and Polished
- H—Blued
- J—Nickel Plated Only
- K—Hardened and Nickel Plated
- L—Brass Plated
- M—Oxidized
- N—Japanned, Dull
- P—Japanned, Bright
- R—Merlized
- T—Copper Plated
- T. A.—Hardened, Polished, Copper and Nickel Plated and Buffed.
- T. B.—Copper and Nickel Plated and Polished.
- T. J.—Copper and Nickel Plated Only.
- T. K.—Hardened, Copper and Nickel Plated.
- T. M.—Copper Plated and Oxidized.
- T. L.—Copper and Brass Plated.
- U—Zinc Plated
- V—Silver Plated
- W—Polished and Nickel Plated
- Z—Chromium Plated
- Z. B.—Polished, Nickel Plated, Buffed and Chromium Plated
- Z. J.—Nickel and Chromium Plated.

These letters **MUST BE USED** when they appear in the list; and **AFTER** the number as in the list.

In this series:

- 1 to 1500 and 50001 to 51500 are Screw Numbers.
- 1501 to 1800 and 51501 to 51800 are Nut Numbers.
- 1801 to 2000 and 51801 to 52000 are Roller Numbers.
- 2001 to 50000 and 52001 and upward are numbers of Machine Parts.

The figures in the second column refer only to the plates, illustrating the parts, and are **NOT TO BE USED** in ordering.

Parts marked with an asterisk (*) are furnished only when repairs are made at factory.

LIST OF PARTS COMPLETE

FOR

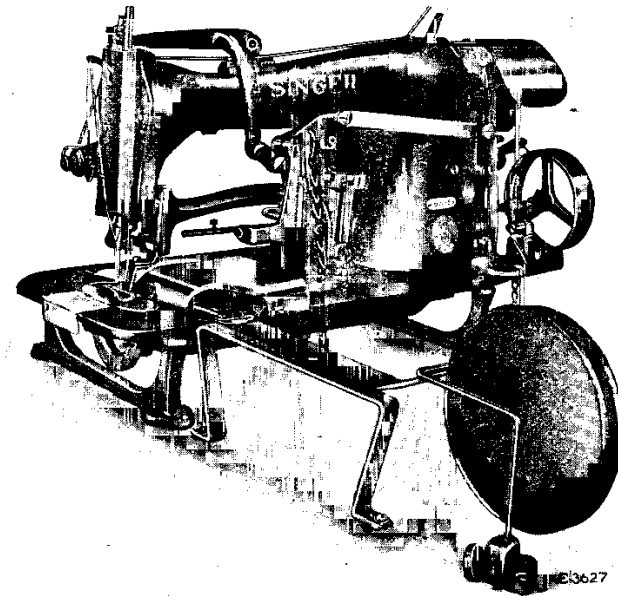

MACHINE No. 68-35

FOR STITCHING TAPE REINFORCEMENTS, $1\frac{1}{8} \times \frac{1}{2}$ INCHES, FOR BUTTONS AND BUTTONHOLES, ON UNDERSIDE OF UNION SUITS; ALSO FOR STITCHING LAUNDRY TAGS ON SHIRTS, UNDERWEAR, ETC. THE MACHINE MAKES 42 STITCHES INCLUDING THE TYING STITCHES AND IS FITTED WITH AN AUTOMATIC DEVICE FOR CARRYING A FOLDED STRIP FROM A REEL TO THE CARRYING CLAMP, AT WHICH POINT IT IS AUTOMATICALLY CREASED AND CUT TO THE REQUIRED LENGTH, BY DEPRESSING THE FOOT TREADLE, THE FOOT OF THE WORK HOLDING CLAMP IS RAISED, THE CUT REINFORCEMENT IS ADVANCED, THE ENDS FOLDED AND IT IS PLACED IN POSITION IN THE WORK HOLDING CLAMP READY TO BE STITCHED TO THE GARMENT.

NO.	PLATE	NAME
63855	7220	Arch Clamp Foot.....
17958	7220	“ “ “ Lifter with 17866
190d	7220	“ “ “ “ Screw.....

NO.	PLATE	NAME
17959	7220	Arch Clamp Foot Lifting Stud.....
1209K	7220	“ “ “ Screw.....
49109	7220	“ “ “ Washer.....
63856	7220	“ “ “ Shank with 17959.....
63857	7220	“ “ “ “ Plate.....
217J	3778	“ “ “ “ “ Screw....
39303	7220	“ “ “ “ Spring.....
217J	3778	“ “ “ “ “ Screw (lower).....
50008J	7220	Arch Clamp Foot Shank Spring Screw (upper).....
63858	7221	Arch Clamp Frame.....
14079	7220	“ “ “ Dowel Pin.....
181D	7220	“ “ “ Screw.....
63859	—	Arch Clamp complete, Nos. 225K, 1209K, 39303, 49109, 50008J, 63855 to 63858, 63865, 63867, two each 181D, 14079 and five 217J.....
*63989	—	Arm with 4449, 17844 and two 164E....
2002	3777	“ Dowel Pin.....
4448	3777	“ Oil Tube, for intermediate bearing..
880E	3724	“ Screw.....
17702	3728	“ Shaft.....
17703	7222	“ “ Bushing (back).....
50333C	7230	“ “ “ “ Adjusting Screw.....
1520E	3724	Arm Shaft Bushing (back) Adjusting Screw Nut.....
*4449	—	Arm Shaft Bushing (front).....
124674	7245	“ Side Cover.....
190D	7220	“ “ “ Screw.....
*63860	—	Bed.....
63861	7223	“ Cover.....
203J	7230	“ “ “ Screw.....
7071	3777	“ “ “ Washer.....
18498	7223	Belt Cover.....
39290	3774	“ “ Bracket with 184E and 17741
184E	3778	“ “ “ “ Screw Stud.....
17741	7220	“ “ “ “ Stud.....
217D	3778	“ “ “ “ “ Screw.....
39222	3774	“ Shifter.....
63976	7244	“ “ Clamp.....
1255D	3776	“ “ “ “ Screw.....
4292	3790	Crank Connecting Rod with 4349 and two 145E.....
*4349	—	Crank Connecting Rod Cap.....
145E	3778	“ “ “ “ “ Screw.....

NO.	PLATE	NAME
375c	3724	Crank Connecting Rod Hinge Screw....
1518E	3718	“ “ “ “ “ Nut
17724	3790	Face Plate.....
*63736	—	“ “ “ “ 17724 with 2105.....
17725	—	Face Plate complete, Nos. 448c, 600c, 1560c, 2103, 2107, 2124, 2127, 63736 and two each 233D and 2102.....
164D	3724	Face Plate Screw.....
2107	3777	“ “ Thread Guard.....
233D	3777	“ “ “ “ “ Screw.....
63940	7244	Feed Across Connection (lever end) with 42076 and two 896E.....
63941	—	Feed Across Connection (lever end) 63940 with 55381.....
55381	7244	Feed Across Connection (lever end) Ball Stud.....
1185c	3714	Feed Across Connection (lever end) Ball Stud Set Screw.....
63942	7244	Feed Across Connection (regulator end) with 42076 and two 896E.....
63943	—	Feed Across Connection (regulator end) 63942 with 63944.....
63944	7244	Feed Across Connection (regulator end) Ball Stud.....
17726	3714	Feed Across Connection Adjusting Stud
1649c	3714	“ “ “ “ “ “ Nut (left).....
1650c	3714	Feed Across Connection Adjusting Stud Nut (right).....
*42076	—	Feed Across Connection Cap.....
896E	7244	“ “ “ “ “ Screw.....
17729	3790	“ “ “ “ Lever with 1185c and 1952..
39309	3790	“ “ “ “ Bracket with 39310 and three 160D.....
*39310	—	Feed Across Lever Bracket Cap.....
160D	3714	“ “ “ “ “ “ “ Screw...
8589	3777	“ “ “ “ “ Dowel Pin...
1177D	7230	“ “ “ “ “ “ Screw.....
17737	3714	“ “ “ “ “ Hinge Stud.....
160D	3714	“ “ “ “ “ “ “ Clamping Screw.....
1952	3714	Feed Across Lever Roller and Stud.....
63862	7222	“ “ “ Plate with 17741.....
164F	3724	“ “ “ “ “ Screw.....
39428	7222	“ “ “ “ Regulator.....
50599D	7244	“ “ “ “ “ Adjusting Screw Stud.....

NO.	PLATE	NAME
1676c	3778	Feed Across Regulator Adjusting Screw Stud Nut.....
46244	7244	Feed Across Regulator Adjusting Screw Stud Nut Washer (fibre).....
17738	7220	Feed Across Regulator Adjusting Screw Stud Nut Washer (steel).....
1188b	3724	Feed Across Regulator Hinge Screw.....
39429	7220	" " " Link.....
1189b	7220	" " " " Screw Stud..
17741	7220	" " " " Stud.....
717c	7220	" " " " Stop Screw.....
63863	7222	" " " " " Bracket with two each 717c and 1520E.....
690b	3794	Feed Across Regulator Stop Screw Bracket Screw.....
1520b	3724	Feed Across Regulator Stop Screw Nut..
39430	3791	" Cam with 17874 and two each 190b and 1192c.....
18415	7222	Feed Cam Driving Worm with 1441c and 1442c.....
1442c	3778	Feed Cam Driving Worm Position Screw
1441c	3778	" " " " Set Screw.....
17797	3790	" " " " Wheel with 453c
3012	3777	" " " " " Pin.....
453c	7230	" " " " " Set Screw
18384	3777	" " " Pin.....
1192c	3724	" " " Set Screw.....
62155	7246	" " " Shaft.....
*62264	—	" " " 62155 with 1653c and 17797.....
1653c	3724	Feed Cam Shaft Nut.....
63864	7221	" Plate.....
63865	—	Feed Plate complete, Nos. 63864, 63868 to 63871 and four each 707j and 50470j
63866	7221	Feed Plate Carrier Bar.....
63867	—	" " " " 63866 with 934j, 17802, 18368, 18488, 63921 and two 7476.....
17802	7224	Feed Plate Carrier Bar Block.....
7476	7224	" " " " " Steady Pin
17805	3714	" " " " " Pivot Block.....
1194b	3714	" " " " " Screw
18368	3714	" " " " " Plate.....
934j	3714	" " " " " Screw.....
225k	7230	" " " Screw.....
63868	7224	" " " Strip Folder (left).....
63869	7224	" " " " " (right).....

NO.	PLATE	NAME
707j	7224	Feed Plate Strip Folder Screw.....
63870	7224	" " " Spring (left).....
63871	7224	" " " " " (right).....
50470j	7224	" " " " " Screw.....
39361	7222	" Regulator with 1953.....
17744	7224	" " " Hinge Stud.....
18488	7221	" " " Post.....
18489	7224	" " " " Guide.....
810d	7224	" " " " " Cap Screw...
1953	7224	" " " Roller and Screw Stud with 1655c and 14017.....
1655c	7224	Feed Regulator Roller and Screw Stud Nut.....
14017	7224	Feed Regulator Roller and Screw Stud Nut Washer.....
39313	3794	Feed Regulator Swivel.....
50269f	7230	" " " Screw.....
17807	3794	Knife (needle thread).....
17808	3794	" (shuttle thread).....
*63806	—	" Bar.....
63807	—	" " 63806 with 63808, 63809 and two 17814.....
39299	3774	Knife Bar 63807 with 704c and 39300....
17810	3794	" " " Cap (back).....
690b	3794	" " " " " Screw.....
17811	3794	" " " (front).....
160b	3714	" " " " " Screw.....
39262	3776	" " " (intermediate).....
39263	—	" " " " " 39262 with 1328e, 1517e, 39264 and 39265.....
690b	3794	Knife Bar Cap (intermediate) Screw....
39264	3776	" " " " " Stop Pin
1328e	3776	" " " " " " " Screw Bushing.....
1517e	3776	Knife Bar Cap (intermediate) Stop Pin Screw Bushing Nut.....
39265	3776	Knife Bar Cap (intermediate) Stop Pin Spring.....
63808	7224	Knife Bar Connection.....
17814	3794	" " " " Rivet.....
17915	3794	" " " " " Slide Block.....
63809	—	" " " " " " " 17915 with 63810.....
63810	7224	Knife Bar Connection Slide Block Stud..
39297	3794	" " " Driving Lever with 190b, 1420e, 17919, and 39298.....

NO.	PLATE	NAME
1382f	3778	Knife Bar Driving Lever Hinge Screw....
1681c	3778	" " " " " " Nut
39298	3794	" " " " Lock Stud
17919	3794	" " " " " "
		Spring.....
190d	7220	Knife Bar Driving Lever Lock Stud
		Spring Screw.....
1420e	3794	Knife Bar Driving Lever Lock Stud Stop
		Screw.....
17820	3795	Knife Bar Extension.....
17750	—	" " " " 17820 with 17821 and
		two 17822.....
190d	7220	Knife Bar Extension Screw.....
7071	3777	" " " " Washer.....
17821	3795	" " Rack.....
17822	3795	" " " Rivet.....
39300	3776	" " Stop Block.....
19793	3777	" " " " Dowel Pin.....
704c	3776	" " " " Screw.....
39235	7222	" Cam Lever Body.....
39409	—	" " " " 39235 with 39460
39329	7222	Knife Cam Lever complete, Nos. 19793
		and 39409.....
39332	3774	Knife Cam Lever Bracket with 1177d....
8589	3777	" " " Bracket Dowel Pin....
1177d	7230	" " " " Screw.....
50029c	3776	" " " Hinge Screw.....
18471	3776	" " " " Bushing
*18472	—	" " " " " "
		18471 with 50029c.....
1980	3776	Knife Cam Lever Roller and Screw Stud
		with 1654c.....
1654c	7230	Knife Cam Lever Roller and Screw Stud
		Nut.....
39330	3776	Knife Cam Lever Slide with 1980.....
39460	—	" " " " 39330 with 1255d
		and 39331.....
1255d	3776	Knife Cam Lever Slide Screw.....
39331	3776	" " " " Washer....
19793	3777	" " " " Steady Pin.....
39269	3795	Knife Holder with 1336c, 17826, 17830
		and two 7298.....
*39488	—	Knife Holder 39269 with 1198c, 17807,
		17808 and 17829.....
17826	3795	Knife Holder Pinion.....
7298	3795	" " " Dowel Pin.....
17827	3795	" " " Stud.....

NO.	PLATE	NAME
39270	3795	Knife Holder Pinion Stud Bracket with
		17827.....
50018f	3778	Knife Holder Pinion Stud Bracket Screw
1698c	3778	" " " " " "
		Nut.....
1198c	7230	Knife Screw.....
17829	3795	" Thread Holder.....
17830	3795	" " " Position Pin.....
39291	3795	" " Retainer with 39277 and
		two 39278.....
39277	3795	Knife Thread Retainer Finger.....
39278	3795	" " " Rivet.....
1336c	3795	" " " Screw Stud.....
17831	7222	Needle Bar with 237f.....
*39203	3718	" " Connecting Link.....
63756	—	" " " " 39203 with
		21629.....
377c	3718	Needle Bar Connecting Link Hinge Screw
1518e	3718	" " " " " "
		Nut.....
21629	3718	Needle Bar Connecting Link Stud with
		155c.....
155c	3718	Needle Bar Connecting Link Stud Set
		Screw.....
39350	7222	Needle Bar Thread Nipper Driving Lever
		(adjustable) with 39351 and two 335d.
39351	3776	Needle Bar Thread Nipper Driving Lever
		Extension.....
335d	3776	Needle Bar Thread Nipper Driving Lever
		Extension Screw.....
1196c	3721	Needle Bar Thread Nipper Driving Lever
		Hinge Screw.....
39352	7222	Needle Bar Thread Nipper Driving Lever
		Spring.....
17834	3718	Needle Bar Thread Nipper Lever with
		17835.....
17835	3718	Needle Bar Thread Nipper Lever Bushing
1200d	3718	" " " " " Hinge
		Screw.....
39276	3776	Needle Bar Thread Nipper Lever Spring
1329d	3776	" " " " " "
		Screw.....
17837	7222	Needle Bar Thread Nipper Rod.....
17838	3718	" " " " " Adjusting
		Stud.....
1651e	7230	Needle Bar Thread Nipper Rod Adjusting
		Stud Lock Nut.....

NO.	PLATE	NAME
17839	3718	Needle Bar Thread Nipper Rod Arm with 196F.....
196F	3718	Needle Bar Thread Nipper Rod Arm Set Screw.....
17840	7222	Needle Bar Thread Nipper Rod Support
190D	7220	" " " " " "
		Screw.....
237F	3724	Needle Set Screw.....
*4304	3790	Oscillating Rock Shaft with 4784.....
5747	---	Oscillating Rock Shaft complete, Nos. 635c, 1513J, 4304 and 56812.....
3052	3790	Oscillating Rock Shaft Hinge Pin.....
56812	---	" " " " " " 3052 with 1513J.....
1513J	3724	Oscillating Rock Shaft Hinge Pin Nut.....
635c	3724	" " " " " " Screw Stud.....
1513J	3724	Oscillating Rock Shaft Hinge Pin Screw Stud Nut.....
4784	3702	Oscillating Rock Shaft Oil Pad.....
3053	7225	" Shaft.....
*15160	---	" " Crank for 15161.....
15425	---	" " " " 15162.....
*15161	---	Oscillating Shaft Crank complete, Nos. 462c, 1519E, 15160 and 15171.....
15162	3702	Oscillating Shaft Crank complete, Nos. 1519E, 15171, 15425 and two 462c.....
2049	3702	Oscillating Shaft Crank Pin.....
462c	3702	" " " Set Screw.....
15170	3702	" " " Slide Block.....
226D	7244	" " " " " Cap Screw.....
12424	3702	Oscillating Shaft Crank Slide Block Cap Screw Washer.....
1035c	3702	Oscillating Shaft Crank Slide Block Screw Stud.....
1519E	3702	Oscillating Shaft Crank Slide Block Screw Stud Nut.....
15171	3702	Oscillating Shaft Crank Slide Block complete, Nos. 226D, 1035c, 12424 and 15170
2058	7225	Presser Bar.....
17841	3718	" " Collar with two 196F.....
196F	3718	" " " Set Screw.....
17842	3718	" " Guide Bracket with 453c.....
453c	7230	" " " Set Screw.....
63872	7225	" " Lifting Bell Crank.....
17844	7225	" " " " " Bracket

NO.	PLATE	NAME
164E	3724	Presser Bar Lifting Bell Crank Bracket Screw.....
63873	7224	Presser Bar Lifting Bell Crank Connecting Link.....
63c	7224	Presser Bar Lifting Bell Crank Connecting Link Hinge Screw.....
1201c	7230	Presser Bar Lifting Bell Crank Hinge Screw.....
23483	7224	Presser Bar Lifting Bell Crank Spring...
32675	7245	" " Spring.....
63975	7246	Pulley (loose) 2 3/4 in. diam.....
17848	7225	" " Bushing.....
2269	3777	" " " Position Pin.....
1202R	3724	" " Cap Screw.....
17942	3774	" (tight) 2 1/8 in. diam., with 2269...
2022	3777	" " Pin.....
17955	---	Pulleys complete, Nos. 1202R, 1206c, 17848, 17854, 17942 and 63975.....
2073	3702	Shuttle Bobbin.....
2211	3702	" " Retaining Spring.....
2212	3702	" " " " Rivet...
*39295	---	" Body with 398E, 2082, 2084, 2211 and two 2212.....
*2075	---	Shuttle Cover.....
*44001	---	" " 2075 with 112D, 2078, 2080, 2086 and 2090.....
2076	3702	Shuttle Cover Hinge Pin.....
2078	3702	" Delivery Eye Thread Guard.....
2080	3702	" " " " Rivet
2082	3702	" Main Spring.....
398E	3702	" " " Screw.....
2084	3702	" " " Steady Pin.....
466H	3702	" Tension Regulating Screw.....
2086	3702	" " Spring.....
2090	3702	" " " Plate.....
112D	3702	" " " " Screw.....
39296	3702	Shuttle complete, Nos. 2073, 2076, 39295 and 44001.....
39487	3702	Shuttle Driver with two 457c.....
2049	3702	" " Pin.....
457c	3702	" " Set Screw.....
17746	3719	" Race Back with 17747.....
190c	7220	" " " Screw.....
17747	3719	" " " Thread Guard Pin....
63814	---	" " Body.....
63815	3719	Shuttle Race complete, Nos. 17746, 63814 and two 190c.....

PARTS FOR MACHINE NO. 68-35

NO.	PLATE	NAME
158E	3724	Shuttle Race Screw.....
17853	7225	Starting Lever.....
1262c	3778	" " Hinge Screw.....
1662c	3778	" " " " Nut.....
17886	7225	" " Pitman.....
17854	3721	Stop Cam.....
17855	3721	" " Interlocking Rod.....
63977	7246	" " " " Case.....
63978	—	" " " " " " 63977 with 18443 and two 193D.....
63993	—	Stop Cam Interlocking Rod Case 63978 with 63976 and two 1250D.....
*39405	—	Stop Cam Interlocking Rod Case 63993 with 1318D, 17855, 17863, 17864 and 39222.....
63874	7225	Stop Cam Interlocking Rod Case Bracket
63875	—	Stop Cam Interlocking Rod Case Bracket complete, Nos. 1182E, 1196C, 1204E, 1254C, 1262C, 1508E, 1662C, 17853, 17859, 17861, 17862, 17872, 17873, 39405, 63874 and two 898D.....
63876	—	Stop Cam Interlocking Rod Case Bracket 63875 with 39343, 39344 and two 1186D
16532	3777	Stop Cam Interlocking Rod Case Bracket Dowel Pin.....
1343E	3778	Stop Cam Interlocking Rod Case Bracket Screw.....
1204E	3721	Stop Cam Interlocking Rod Case Hinge Screw.....
17859	7225	Stop Cam Interlocking Rod Case Socket Joint.....
898D	3721	Stop Cam Interlocking Rod Case Socket Joint Cap Screw.....
39343	3774	Stop Cam Interlocking Rod Case Spring (flat).....
50682c	7244	Stop Cam Interlocking Rod Case Spring Adjusting Screw.....
1520E	3724	Stop Cam Interlocking Rod Case Spring Adjusting Screw Nut.....
39344	3776	Stop Cam Interlocking Rod Case Spring Bracket with 1520E and 50682c.....
1186D	7230	Stop Cam Interlocking Rod Case Spring Bracket Screw.....
17861	3721	Stop Cam Interlocking Rod Case Stop Stud.....
1254c	3778	Stop Cam Interlocking Rod Case Stop Stud Bushing.....

PARTS FOR MACHINE NO. 68-35

NO.	PLATE	NAME
1508E	3778	Stop Cam Interlocking Rod Case Stop Stud Screw Bushing Lock Nut.....
17862	3721	Stop Cam Interlocking Rod Case Stop Stud Spring.....
18443	7224	Stop Cam Interlocking Rod Case Stop Wearing Block.....
193D	7224	Stop Cam Interlocking Rod Case Stop Wearing Block Screw.....
63877	7225	Stop Cam Interlocking Rod Locking Lever with 1520E and 50384E.....
50384E	7230	Stop Cam Interlocking Rod Locking Lever Adjusting Screw.....
1520E	3724	Stop Cam Interlocking Rod Locking Lever Adjusting Screw Lock Nut.....
63878	7225	Stop Cam Interlocking Rod Locking Lever Connection.....
63c	7224	Stop Cam Interlocking Rod Locking Lever Connection Hinge Screw.....
788D	7230	Stop Cam Interlocking Rod Locking Lever Hinge Screw.....
17863	3721	Stop Cam Interlocking Rod Spring.....
17864	3721	" " " " Stop.....
1318D	7230	" " " " " " Screw..
3012	3777	" " Pin.....
1206c	3721	" " Screw.....
63879	7226	Strip Carrier.....
63880	7226	Strip Carrier complete, Nos. 63879, 63881 to 63884, two 26459 and four each 185J and 120299.....
63881	7226	Strip Carrier Plate.....
63882	7226	" " " " Bar (left).....
63883	7226	" " " " (right).....
63884	7226	" " " " Block.....
185J	7230	" " " " " " Screw.....
120299	7227	" " " " Rivet.....
26459	7227	" " Rivet.....
63885	7226	" " Lever.....
63886	7226	" " " " Bracket with 430c and 1520E.....
8589	3777	Strip Carrier Lever Bracket Dowel Pin..
1177D	7230	" " " " " " Screw.....
1201c	7230	" " " " Hinge Screw.....
50131c	7230	" " " " Screw Stud.....
430c	3776	" " " " Stop Screw.....
1520E	3724	" " " " " " Nut.....
63887	7224	" " " " Swivel.....
439c	7224	" " " " " " Screw Stud.....

NO.	PLATE	NAME
63888	7226	Strip Cover.....
665J	7227	“ “ Screw.....
63889	7227	“ Clamp.....
63890	7227	“ “ Hinge Bearing.....
50411J	7227	“ “ “ “ Screw.....
9320	7227	“ “ “ Pin.....
63891	7227	“ Feed Awl.....
63892	7226	“ “ Lever.....
63893	7227	“ “ “ Connection (left).....
78c	7227	“ “ “ “ Hinge Screw.....
63894	7227	Strip Feed Lever Connection (right).....
191c	7227	“ “ “ “ “ Screw
49109	7220	“ “ “ “ “ “ Washer.....
63895	—	Strip Feed Lever Connection, complete, Nos. 191c, 49109, 63893 and 63894....
29D	7230	Strip Feed Lever Hinge Screw.....
50471E	7227	“ “ “ Regulating Screw Stud
1611E	7227	“ “ “ “ “ “ Nut.....
9525	7227	Strip Feed Lever Regulating Screw Stud Nut Washer.....
63896	7227	Strip Feed Lever Stop.....
203J	7230	“ “ “ “ Screw.....
63897	7221	“ “ Plate with two 63903.....
63898	—	Strip Feed Plate complete, Nos. 206D, 1097F, 8388, 9320 63889, 63891, 63897, 63900, 63901, 63907 to 63910 and two each 665J, 707J, 1019c, 1253c, 50411J and 63890.....
63899	7227	Strip Feed Plate Connecting Link.....
50076K	7227	“ “ “ “ “ Hinge Screw.....
63900	7227	Strip Feed Plate Cover.....
665J	7227	“ “ “ “ Screw.....
63901	7227	“ “ “ Extension.....
707J	7224	“ “ “ “ Screw.....
63902	7227	“ “ “ Gib.....
207J	3778	“ “ “ “ Screw.....
63903	7227	“ “ “ Pin.....
63904	7221	“ Guide (lower).....
63905	7221	“ “ (upper).....
63906	7221	“ “ Bracket.....
160D	3714	“ “ “ Screw.....
203J	7230	“ “ “ Screw.....
7071	3777	“ “ Washer.....

NO.	PLATE	NAME
63907	7227	Strip Knife (lower).....
8388	7227	“ “ “ Spring.....
1019c	7227	“ “ “ “ Screw.....
1019c	7227	“ “ “ “ “ Lock Screw.....
1097F	7227	Strip Knife (lower) Stop Screw.....
63908	7227	“ “ (upper).....
63909	7227	“ “ “ Bell Crank.....
63910	7227	“ “ “ “ “ Hinge Stud.....
1253c	7227	Strip Knife (upper) Bell Crank Hinge Stud Set Screw.....
63911	7221	Strip Knife (upper) Bell Crank Pitman
63912	7224	“ “ “ “ “ “ Stud.....
63913	7224	Strip Knife (upper) Bell Crank Pitman Stud Bushing.....
43804	7224	Strip Knife (upper) Bell Crank Pitman Stud Collar with 1253c.....
1253c	7227	Strip Knife (upper) Bell Crank Pitman Stud Collar Set Screw.....
1229c	7224	Strip Knife (upper) Bell Crank Pitman Set Screw.....
28094	7224	Strip Knife (upper) Bell Crank Pitman Set Screw Extension Pin.....
63982	7244	Strip Knife (upper) Bell Crank Spring
50166E	7244	“ “ “ “ “ “ Screw Stud.....
206D	7227	Strip Knife (upper) Screw.....
63914	7226	“ Measuring Bar.....
1520E	3724	“ “ “ Nut.....
714J	7230	“ “ “ Thumb Screw.....
63915	7223	“ “ “ Plate.....
63916	—	“ “ “ 63915 with 658J, 63888 and two 665J.....
63917	—	Strip Measuring Plate 63916 with two each 9525 and round head wood screws 1 in. No. 10.....
9525	7227	Strip Measuring Plate Screw Washer....
658J	7230	“ “ “ Thumb Screw.....
63918	7226	“ Retaining Spring.....
63919	7226	“ “ “ Holder.....
63920	7226	“ “ “ “ 63919 with 63918 and two 707J.....
1425J	7230	Strip Retaining Spring Holder Hinge Screw.....

PARTS FOR MACHINE NO. 68-35

NO.	PLATE	NAME
63921	7224	Strip Retaining Spring Holder Stud.....
707J	7224	" " " Screw.....
2102	3777	Tension Disc.....
1560c	3777	" Regulating Thumb Nut.....
600c	3777	" Screw Stud.....
448c	3778	" " " Set Screw.....
2103	3777	" Spring.....
2105	3777	" Thread Guard.....
*63749	—	Thread Take-up Cam.....
39204	3790	" " " 63749 with 446c...
3012	3777	" " " Pin.....
446c	3724	" " " Set Screw.....
*3072	7226	" " Lever with 1819.....
56855	—	" " " 3072 with 1088c..
1088c	7230	" " " Hinge Screw.....
1819	3724	" " " Roller and Stud..
2124	3777	" " Spring.....
2127	3777	" " " Regulator Plate
233D	3777	" " " " " "
		Adjusting Screw.....
17865	7229	Thread Wiper Body.....
1207D	7229	" " " Hinge Screw.....
17866	7229	" " " Hook.....
17867	7229	" " " Support.....
641c	3778	" " " " Set Screw..
17868	7229	" " " Wire.....
337D	3718	" " " " Screw.....
17869	7229	" " " " Washer.
63922	7228	Throat Plate with 17749, 63923 and two
		each 1208E and 50406D.....
63924	—	Throat Plate 63922 with 1698c, 39270,
		39291, 39488 and 50018F.....
17749	7228	Throat Plate Extension.....
50406D	7228	" " " Screw.....
63923	7228	" " Needle Hole Bushing.....
1208E	7228	" " " " " Screw
691F	3724	" " " Screw.....
17872	3721	Trip Lever.....
1196c	3721	" " Hinge Screw.....
17873	3721	" " Spring.....
1182E	7230	" " " Screw.....
17874	7229	Tripping Point.....
190D	7220	" " " Screw.....

IRON BASE

NO.	PLATE	NAME
39483	3777	Bed Frame Cushion (leather).....
39325	3776	" " Hinge Connection.....
9261	3776	" " " " Pin.....
453c	7230	" " " " Set Screw.
39232	3749	" " Side Cover.....
39233	3749	Bed Frame with 39232, two each 9261,
		39325, 39483 and four wood screws 1/4
		in. No. 12.....
39234	3750	Drip Pan for 39233.....

ATTACHMENTS AND ACCESSORIES

NO.	PLATE	NAME
120346	4079	Oiler (copper plated) with 120347.....
120347	4079	" Spout, 9 in. long.....
41401	7231	Machine Rest Pin (wood).....
11831	7231	Screw Driver (large).....
26026	3727	" " (medium).....
26485	3727	" " (small).....
17875	3728	Table Bracket Machine Holder with 2809,
		7263, 39484 and two wood screws 1/4
		in. No. 10.....
7263	3718	Table Bracket Machine Holder Con- nection.....
2809	3718	Table Bracket Machine Holder Con- nection Hinge Pin.....
453c	7230	Table Bracket Machine Holder Con- nection Set Screw.....
39484	3718	Table Bracket Machine Holder Cushion (leather).....
17905	3727	Wrench for 1654, 1655 and 1676.....
27662	3727	" " 1254 and 1508.....
22003	3727	" " 1651.....
4822	3727	" " 17838.....
10875	3727	" " 1518 and 1520.....

BOBBIN WINDER

(SWINGING AUTOMATIC, LEFT HAND)

NO.	PLATE	NAME
41598	3780	Base with 27916 and two 28084.....
1186c	3781	" Screw.....
27916	3781	Brake (leather).....
28084	3781	" Rivet.....
27321	3781	Frame.....

BOBBIN WINDER

NO.	PLATE	NAME
50356d	3781	Frame Hinge Screw.....
1620j	3781	“ “ “ Nut.....
41825	3781	“ Spring.....
41600	3780	Pulley with 155c.....
155c	3781	“ Set Screw.....
27305	3781	Spindle.....
27326	3781	Stop Latch.....
35d	3781	“ Hinge Screw.....
60769	3780	Tension Bracket.....
60770	3780	Tension Bracket complete, Nos. 419E, 1562j, 8422, 9780, 43808, 60769 and two 2455.....
9780	3781	Tension Bracket Position Stud.....
161d	3781	“ “ Screw.....
2455	3781	“ Disc.....
1562j	3781	“ Regulating Thumb Nut.....
419E	3781	“ Screw Stud.....
43808	3781	“ Spring.....
8422	3781	“ Thread Guide.....
41713	3780	Bobbin Winder, Nos. 35d, 1620j, 27305, 27321, 27326, 41598, 41600, 41825 and 50356d.....
41714	—	Bobbin Winder (swinging automatic, left hand) complete, Nos. 161d, 41713, 60770 and two 1186c.....

KNIFE GRINDER

FOR 63907 AND 63908

NO.	PLATE	NAME
27565	1104	Emery Wheel, 2 in. diam.....
1508j	1105	“ “ Clamping Nut.....
27822	1105	“ “ “ Washer....
27567	1105	“ “ Shaft.....
60934	—	“ “ “ 27567 with 1508j, 27565, 27569 and 27822.....
27568	1105	Emery Wheel Shaft Oil Hole Cover (leather).....
27569	1105	Emery Wheel Shaft Pulley.....
310k	1105	“ “ “ Screw Centre.....
1516j	1105	“ “ “ “ Nut...
27564	1104	Frame with 27574.....
126241	7245	Knife Clamp.....
9686	7244	“ “ “ Position Pin.....
732j	7244	“ “ “ Thumb Screw.....
27929	7244	“ “ “ “ Spring.....
126242	7245	“ Holder with 9686.....

KNIFE GRINDER

NO.	PLATE	NAME
126243	—	Knife Holder complete, Nos. 732j, 27929, 126241 and 126242.....
27323	1105	Knife Holder Guide Bar.....
27572	1104	“ “ “ “ Bracket with 27574.....
310k	1105	Knife Holder Guide Bar Bracket Screw Centre.....
1516j	1105	Knife Holder Guide Bar Bracket Screw Centre Nut.....
27573	1105	Knife Holder Guide Bar Bracket Spring
27574	1105	“ “ “ “ “ “ Hook.....
27659	1105	Knife Holder Stop Collar with 237k.....
237k	1105	“ “ “ “ Set Screw.....
261j	1105	“ “ Regulating Thumb Screw.....
27662	1104	Wrench for 1508 and 1516.....
60583	5918	Knife Grinder, Nos. 261j, 27323, 27564, 27572, 27573, 27659, 60934, two 27568 and four each 310k and 1516j.....
126244	—	Knife Grinder complete, Nos. 27662, 60583, 126243 and three wood screws 1 in. No. 10.....

STAND

FOR ELECTRIC MOTOR
OBSOLETE, USE 25291

NO.	PLATE	NAME
25490	—	Belt, size $\frac{1}{4}$ in., length 36 in., with 25127.
25127	7229	“ Hook.....
46667	7219	Brace.....
748r	7230	“ Screw.....
82973	7219	Leg.....
4881	7219	Motor Treadle.....
46614	7219	“ “ Bracket (left).....
1177E	7230	“ “ “ “ Screw.....
46615	7219	“ “ “ (right).....
1177E	7230	“ “ “ “ Screw....
4879	7231	“ “ Chain Connecting Link...
4882	7231	“ “ Shaft.....
4883	7231	“ “ Spring.....
46616	7219	Motor Treadle complete, Nos. 4879, 4881 to 4883, 46614 and 46615.....
4881	7219	Starting Treadle.....
46614	7219	“ “ Bracket (left).....
1177E	7230	“ “ “ “ Screw....
46615	7219	“ “ “ (right).....

STAND

NO.	PLATE	NAME
1177E	7230	Starting Treadle Bracket (right) Screw ..
4879	7231	" " Chain Connecting Link.
4882	7231	" " Shaft.....
4883	7231	" " Spring.....
46616	7219	Starting Treadle complete, Nos. 4879, 4881 to 4883, 46614 and 46615.....
46617	7219	Treadle Support.....
46618	---	" " 46617 with two 46616 and four 1177E.....
780R	7230	Treadle Support Bolt with 1600R.....
1600R	7230	" " " Nut.....
25086	7231	Wrench.....
25285	---	Stand (iron work) complete, Nos. 25086, 46618, 46667, two each 780R, 82973 and four 748R.....
5670	---	Presser Bar Lifting Lever Chain, length 26 in. to 35 in., with 56864 and 56865.
6439	---	Starting Lever Chain, length 36 in. to 45 in., with 56864 and 56865.....

NOTE: When ordering Nos. 5670 or 6439 give
length required.

56864	7231	Chain Hook (large).....
56865	7229	" " (small).....

STAND 25291

FOR 1/4 H. P. ELECTRIC TRANSMITTER
OBSOLETE

NO.	PLATE	NAME
46673	7241	Brace.....
51009R	3842	" Bolt with 51571R.....
51571R	7245	" " Nut.....
9281R	3845	" " " Washer.....
46674	7241	Leg.....
46675	7241	" Brace.....
51088R	3842	" " Bolt (lower) with 51581R.....
51581R	7245	" " " " Nut.....
67425	3845	" " " " Lock Washer
2018R	3845	" " " " " Washer.....
51083R	3842	" " " (upper with 51581R.....
51581R	7245	" " " " Nut.....
67425	3845	" " " " Lock Washer
9842R	3845	" " " " " Washer.....
46676	7242	" " Bracket (left).....
46677	7242	" " " (right).....
51009R	3842	" " " Bolt with 51571R.....

STAND

NO.	PLATE	NAME
51571R	7245	Leg Brace Bracket Bolt Nut.....
9281R	3845	" " " " " Washer.....
46683	7241	Treadle Support.....
51009R	3842	" " Bolt with 51571R.....
51571R	7245	" " " Nut.....
9281R	3845	" " " " Washer.....
25291	---	Stand (iron work) complete, Nos. 46673, 46676, 46677, 46683, two each 2018R, 9842R, 46674, 46675, 51083R, 51088R, four 67425 and eight each 9281R and 51009R.....

STAND 25297

FOR SINGER INDIVIDUAL AND
1600 SERIES MOTORS

NO.	PLATE	NAME
126508	9090	Leg.....
51057R	3842	" Bolt with 1522E.....
1522E	3845	" " Nut.....
126509	7245	" " " Socket Washer.....
12620	3845	" " Washer.....
46707	9090	" Brace with wood screw 1 in. No. 16.
126530	9090	" Cross Member, 15 1/2 in. long.....
51057R	3842	" " " Bolt with 1522E.....
1522E	3845	" " " " Nut.....
126509	7245	" " " " " Socket Washer.....
12620	3845	" " " " Washer.....
126758	---	Leg with rail complete, Nos. 126530, 126532, two 126508, three 12620 and four each 51057R and 126509.....
126532	9090	Rail, 16 in. long.....
51057R	3842	" Bolt with 1522E.....
1522E	3845	" " Nut.....
126509	7245	" " " Socket Washer.....
12620	3845	" " Washer.....
46711	9090	Treadle Support.....
50297R	3842	" " Bolt with 1522E.....
46712	---	" " " 50297R with 12620 and 46713.....
1522E	3845	Treadle Support Bolt Nut.....
46713	7246	" " " Packing.....
12620	3845	" " " Washer.....
25297	---	Stand (steel work) complete, Nos. 46711 and two each 46707, 46712 and 126578

STARTING LEVER AND FOOT LIFTER PARTS

NO.	PLATE	NAME
6439	—	Foot Lifting Chain, 40 in. long, with 56864 and 56865.....
56864	7231	Foot Lifter Chain Hook (large).....
56865	7229	" " " " (small).....
4879	7231	" " " " for 63925.....
63925	7223	" " Treadle with 443c.....
17881	7231	" " " Shaft.....
443c	7230	" " " " Set Screw.....
17882	3718	" " " Spring.....
17883	3728	" " " Stand.....
63926	7223	Foot Lifter Treadle complete, Nos. 17881 to 17883, 63925 and two wood screws 1 in. No. 10.....
6439	—	Starting Lever Chain, 40 in. long with 56864 and 56865.....
56864	7231	Starting Lever Chain Hook (large).....
56865	7229	" " " " (small).....
4879	7231	" " " " for 17876.....
17876	3728	" " Treadle with 443c.....
17881	7231	" " " Shaft.....
443c	7230	" " " " Set Screw.....
17882	3718	" " " Spring.....
17883	3728	" " " Stand.....
17884	—	Starting Lever Treadle complete, Nos. 17876, 17881 to 17883 and two wood screws 1 in. No. 10.....

STARTING LEVER ROCK SHAFT FOR 25291 AND 25297

NO.	PLATE	NAME
14224	—	Chain, length 10¼ in., with 56864.....
56864	7231	" Hook.....
7124	7242	Rock Shaft.....
27683	7242	" " Arm with two 356c.....
356c	7244	" " " Set Screw.....
16128	7242	" " Hanger with two wood screws 1 in. No. 10.....
2770	7242	Rock Shaft Stop Dog with 356c.....
356c	7244	" " " " Set Screw.....
63981	—	Starting Lever Rock Shaft complete, Nos. 2770, 7124, 14224 and two each 16128 and 27683.....

TABLE BELT GUIDE

NO.	PLATE	NAME
39218	3728	Belt Guide with two 168E.....
168E	7230	" " Set Screw.....
17892	3728	Bracket with two 153E.....
17893	3728	Pulley.....
39219	3728	" Shaft (long) with 17896 and 63973
63973	7246	" " " Wick (braided cotton)
39220	3728	" " (short) with 17896 and 63974.
63974	7246	" " " Wick (braided cotton)
17896	3718	" " Plug.....
153E	3724	" " Set Screw.....
39221	—	Table Belt complete, Nos. 17892, 39219, 39220, two each 17893, 39218 and three wood screws 1¼ in. No. 12.....

TAPE HOLDER

(6 IN. DISC)

NO.	PLATE	NAME
120321	7232	Bracket Wire.....
120322	—	Bracket Wire complete, Nos. 26914, 26918 and 120321.....
26914	7232	Disc.....
26069	—	" Hub.....
26070	7229	" " Rivet.....
26916	—	Disc complete, Nos. 26069, 26914 and three 26070.....
26064	7232	Foot with 736D and three wood screws 1 in. No. 12.....
736D	7230	Foot Screw.....
26918	7232	Tape Guide.....
26073	7229	Tension Adjusting Collar with 286B.....
286B	7230	" " " Thumb Screw.....
13211	7229	" " Spring.....
120323	7232	Tape Holder (straight 6 in. disc) complete, Nos. 13211, 26073, 26916 and 120322.
120324	—	Tape Holder with Foot complete, Nos. 26064 and 120323.....

THREAD UNWINDER

FOR TWO SPOOLS

NO.	PLATE	NAME
225395	7233	Spool Rest with 201018c.....
225388	7233	" " Rod.....
200383c	7229	" " " Set Screw.....

THREAD UNWINDER

NO.	PLATE	NAME
201018c	7229	Spool Rest Set Screw.....
202490	7233	" Stand with 200383c.....
225391	7233	Thread Guide.....
201696J	7229	" " Lock Nut.....
225392	7233	" " Rod with 208E and 225393
208E	3778	" " " Screw.....
225393	7229	" " " Washer.....
225396	7233	Thread Unwinder complete, Nos. 201696J, 202490, 225388, 225392, 225395, two 225391 and three wood screws 1/8 in. No. 12.....
27739	7234	Thread Cone (wood) for large cones.....
225390	7234	" " Holder, for inverted cones..

NOTE: Nos. 27739 and 225390 are used with,
but not included in 225396

OBSOLETE PARTS

NO.	PLATE	NAME
*39279	—	Arm with 4449, 17844 and two 164E.....
39223	3776	Belt Shifter Clamp for 39405.....
158E	3724	Crank Connecting Rod Cap Screw for 4292, use 145E.....
17727	3714	Feed Across Knuckle Joint.....
17728	3714	" " " " Connection
1184J	3714	" " " " "
		Hinge Screw.....
17730	3714	Feed Across Lever Ball Stud.....
17733	3714	" " " Socket Bearing.....
17734	3714	" " " " " Block (two pieces).....
145F	3778	Feed Across Lever Socket Bearing Block Set Screw.....
1528J	3778	Feed Across Lever Socket Bearing Block Set Screw Nut.....
1187E	7220	Feed Across Regulator Adjusting Stud
17739	7220	" " " " "
		Sleeve.....
18416	7222	Feed Cam Shaft.....
18417	7222	" " " Bracket.....
1177D	7230	" " " " Screw (back)...
1193D	3724	" " " " " (front)...
229D	3702	Oscillating Shaft Crank Slide Block Cap Screw for 15171, use 226D.....
8414	7225	Presser Bar Spring, use 32675.....
17941	3774	Pulley (loose) 2 1/4 in. diam., for 17955, use 63975.....

OBSOLETE PARTS

NO.	PLATE	NAME
63945	—	Stop Cam Interlocking Rod Case for 39345
39345	7225	" " " " " 63945 with 18443 and two 193D, for 39405, use 63993.....
430c	3776	Stop Cam Interlocking Rod Case Spring Adjusting Screw Nut for 39344, use 50682c.....

Genuine Singer Needles and their Con-
tainers are marked with the Company's
Trade Mark "SIMANCO." 1

Needles in Containers marked
"For Singer Machines"
are not Singer made needles. 2

NUMERICAL LIST OF PARTS

NO. PLATE	NAME
29D 7230	Strip Feed Lever Hinge Screw.....
35D 3781	Bobbin Winder Stop Latch Hinge Screw for 41713.....
63C 7224	Stop Cam Interlocking Rod Locking Lever Connection Hinge Screw.....
78C 7227	Strip Feed Lever Connection (left) Hinge Screw.....
112D 3702	Shuttle Tension Spring Plate Screw for 44001.....
145E 3778	Crank Connecting Rod Cap Screw for 4292
145F 3778	Feed Across Lever Socket Bearing Block Set Screw, obsolete.....
153E 3724	Table Belt Guide Pulley Shaft Set Screw for 17892.....
155C 3781	Bobbin Winder Pulley Set Screw for 41600
155C 3718	Needle Bar Connecting Stud Set Screw for 21629.....
158E 3724	Crank Connecting Rod Cap Screw for 4292, obsolete, use 145E.....
158E 3724	Shuttle Race Screw.....
160D 3714	Feed Across Lever Bracket Cap Screw for 39309.....
160D 3714	Feed Across Lever Hinge Stud Clamping Screw for 39309.....
160D 3714	Knife Bar Cap (front) Screw.....
160D 3714	Strip Guide Bracket Screw.....
161D 3781	Bobbin Winder Tension Bracket Screw for 41714.....
164D 3724	Face Plate Screw.....
164F 3724	Feed Across Plate Screw.....
164E 3724	Presser Bar Lifting Bell Crank Bracket Screw for 39279, for 63989.....
168E 7230	Table Belt Guide Belt Guide Set Screw for 39218.....
181D 7220	Arch Clamp Frame Screw for 63859.....
184E 3778	Belt Cover Bracket Screw Stud for 39290
185J 7230	Strip Carrier Plate Bar Block Screw for 63880.....
190D 7220	Arm Side Cover Screw.....
190D 7220	Arch Clamp Foot Lifter Screw.....
190D 7220	Knife Bar Driving Lever Lock Stud Spring Screw for 39297.....
190D 7220	Knife Bar Extension Screw.....

NO. PLATE	NAME
190d 7220	Needle Bar Thread Nipper Rod Support Screw.....
190c 7220	Shuttle Race Back Screw for 63815.....
190d 7220	Tripping Point Screw for 39430.....
191c 7227	Strip Feed Lever Connection (right) Screw for 63895.....
193d 7224	Stop Cam Interlocking Rod Case Wearing Block Screw for 39345 and 63978.....
196f 3718	Needle Bar Thread Nipper Rod Arm Set Screw for 17839.....
196f 3718	Presser Bar Collar Set Screw for 17841.....
203j 7230	Bed Cover Screw.....
203j 7230	Strip Feed Lever Stop Screw.....
203j 7230	" Guide Screw.....
206d 7227	" Knife (upper) Screw for 63898.....
207j 3778	" Feed Plate Gib Screw.....
208e 3778	Thread Unwinder Thread Guide Rod Screw for 225392.....
217j 3778	Arch Clamp Foot Shank Plate Screw for 63859.....
217j 3778	Arch Clamp Foot Shank Spring Screw (lower) for 63859.....
217d 3778	Belt Cover Screw.....
225k 7230	Feed Plate Screw for 63859.....
226d 7244	Oscillating Shaft Crank Slide Block Cap Screw for 15171.....
229d 3702	Oscillating Shaft Crank Slide Block Cap Screw for 15171, obsolete, use 226d....
233d 3777	Face Plate Thread Guard Screw for 17725
233d 3777	Thread Take-up Spring Regulator Plate Adjusting Screw for 17725.....
237k 1105	Knife Grinder Knife Holder Stop Collar Set Screw for 27659.....
237f 3724	Needle Set Screw for 17831.....
261j 1105	Knife Grinder Knife Regulating Thumb Screw for 60583.....
286b 7230	Tape Holder Tension Adjusting Collar Thumb Screw for 26073.....
310k 1105	Knife Grinder Emery Wheel Shaft Screw Centre for 60583.....
310k 1105	Knife Grinder Knife Holder Guide Bar Bracket Screw Centre for 60583.....
335d 3776	Needle Bar Thread Nipper Driving Lever Extension Screw for 39350.....
337d 3718	Thread Wiper Body Wire Screw.....
356c 7244	Starting Lever Rock Shaft Arm Set Screw for 27683.....

NO. PLATE	NAME
356c 7244	Starting Lever Rock Shaft Stop Dog Set Screw for 2770.....
375c 3724	Crank Connecting Rod Hinge Screw.....
377c 3718	Needle Bar Connecting Link Hinge Screw
398e 3702	Shuttle Main Spring Screw for 39295....
419e 3781	Bobbin Winder Tension Screw Stud for 60770.....
430c 3776	Stop Cam Interlocking Rod Case Spring Adjusting Screw for 39344, obsolete, use 50682c.....
430c 3776	Strip Carrier Lever Stop Screw for 63886
439c 7224	" " Swivel Screw Stud.....
443c 7230	Foot Lifter Treadle Shaft Set Screw for 63925.....
443c 7230	Starting Lever Treadle Shaft Set Screw for 17876.....
446c 3724	Thread Take-up Cam Set Screw for 39204
448c 3778	Tension Screw Stud Set Screw for 17725..
453c 7230	Bed Frame Hinge Connection Set Screw..
453c 7230	Feed Cam Driving Worm Wheel Set Screw for 17797.....
453c 7230	Presser Bar Guide Bracket Set Screw for 17842.....
453c 7230	Table Bracket Machine Holder Connection Set Screw (Attachments and Accessories).....
457c 3702	Shuttle Driver Set Screw for 39487.....
462c 3702	Oscillating Shaft Crank Set Screw for 15161 and 15162.....
466h 3702	Shuttle Tension Regulating Screw for 44001.....
600c 3777	Tension Screw Stud for 17725.....
635c 3724	Oscillating Rock Shaft Hinge Pin Screw Bearing for 5747.....
641c 3778	Thread Wiper Body Support Set Screw..
658j 7230	Strip Measuring Plate Thumb Screw for 63916.....
665j 7227	Strip Cover Screw for 63916.....
665j 7227	" Feed Plate Cover Screw for 63916..
690d 3794	Feed Across Regulating Stop Screw Bracket Screw.....
690d 3794	Knife Bar Cap (back) Screw.....
690d 3794	" " " (intermediate) Screw.....
691f 3724	Throat Plate Screw.....
704c 3776	Knife Bar Stop Block Screw for 39299....
707j 7224	Feed Plate Strip Folder Screw for 63865..
707j 7224	Strip Feed Plate Extension Screw for 63898

NUMERICAL LIST OF PARTS

NO.	PLATE	NAME
707J	7224	Strip Retaining Spring Screw for 63920...
714J	7230	" Measuring Bar Thumb Screw.....
717C	7220	Feed Across Regulator Stop Screw for 63863.....
732J	7244	Knife Grinder Knife Clamp Thumb Screw for 126243.....
736D	7230	Tape Holder Foot Screw for 26064.....
748R	7230	Brace Screw for 25285, obsolete.....
780R	7230	Treadle Support Bolt with 1600R, for 25285, obsolete.....
788D	7230	Stop Cam Interlocking Rod Locking Lever Hinge Screw.....
810D	7224	Feed Regulator Post Guide Cap Screw...
880E	3724	Arm Screw.....
896E	7244	Feed Across Connection Cap Screw for 63940 and 63942.....
898D	3721	Stop Cam Interlocking Rod Case Socket Joint Cap Screw for 63875.....
934D	3714	Feed Plate Carrier Bar Plate Screw for 63867.....
1019C	7227	Strip Knife (lower) Spring Screw for 63898
1019C	7227	" " " " " Lock Screw for 63898.....
1035C	3702	Oscillating Shaft Crank Slide Block Screw Stud for 15171.....
1088C	7230	Thread Take-up Lever Hinge Screw for 56855.....
1097F	7227	Strip Knife (lower) Stop Screw for 63898
1177D	7230	Feed Across Lever Bracket Screw.....
1177D	7230	" Cam Shaft Bracket Screw (back) obsolete.....
1177D	7230	Knife Cam Lever Bracket Screw for 39332
1177E	7230	Motor Treadle Bracket (left) Screw for 46618, obsolete.....
1177E	7230	Motor Treadle Bracket (right) Screw for 46618, obsolete.....
1177E	7230	Starting Treadle Bracket (left) Screw for 46618.....
1177E	7230	Starting Treadle Bracket (right) Screw for 46618.....
1177D	7230	Strip Carrier Lever Bracket Screw.....
1182E	7230	Trip Lever Spring Screw for 63875.....
1184J	3714	Feed Across Knuckle Joint Connection Hinge Screw, obsolete.....
1185C	3714	Feed Across Connection (lever end) Ball Stud Set Screw for 17729.....
1186C	3781	Bobbin Winder Base Screw for 41714....

NUMERICAL LIST OF PARTS

NO.	PLATE	NAME
1186D	7230	Stop Cam Interlocking Rod Case Spring Bracket Screw for 63876.....
1187E	7220	Feed Across Regulator Adjusting Stud, obsolete.....
1188D	3724	Feed Across Regulator Hinge Screw.....
1189E	7220	" " " Link Screw Stud.....
1192C	3724	" Cam Set Screw for 39430.....
1193D	3724	" " Shaft Bracket Screw (front) obsolete.....
1194D	3714	Feed Plate Carrier Bar Pivot Block Screw
1196C	3721	Needle Bar Thread Nipper Driving Lever Hinge Screw.....
1196C	3721	Trip Lever Hinge Screw for 63875.....
1198C	7230	Knife Screw for 39488.....
1200D	3718	Needle Bar Thread Nipper Lever Hinge Screw.....
1201C	7230	Presser Bar Lifting Bell Crank Hinge Screw.....
1201C	7230	Strip Carrier Lever Hinge Screw.....
1202R	3724	Pulley (loose) Cap Screw for 17955.....
1204E	3721	Stop Cam Interlocking Rod Case Hinge Screw for 63875.....
1206C	3721	Stop Cam Screw for 17955.....
1207D	7229	Thread Wiper Body Hinge Screw.....
1208E	7228	Throat Plate Needle Hole Bushing Screw for 63922.....
1209K	7220	Arch Clamp Foot Screw for 63859.....
1229C	7224	Strip Knife (upper) Bell Crank Pitman Set Screw.....
1253C	7227	Strip Knife (upper) Bell Crank Hinge Stud Set Screw for 63898.....
1253C	7227	Strip Knife (upper) Bell Crank Pitman Stud Collar Set Screw for 43804.....
1254C	3778	Stop Cam Interlocking Rod Case Stop Screw Bushing for 63875.....
1255D	3776	Belt Shifter Clamp Screw for 63993.....
1255D	3776	Knife Cam Lever Slide Screw for 39460..
1262C	3778	Starting Lever Screw for 63875.....
1318D	7230	Stop Cam Interlocking Rod Stop Screw for 39405.....
1328E	3776	Knife Bar Cap (intermediate) Stop Pin Screw Bushing for 39263.....
1329D	3776	Needle Bar Thread Nipper Lever Spring Screw.....
1336C	3795	Knife Thread Retainer Screw Stud for 39269.....

NO. PLATE	NAME
1343E 3778	Stop Cam Interlocking Rod Case Bracket Screw.....
1382F 3778	Knife Bar Driving Lever Hinge Screw...
1420E 3794	" " " " Lock Stud Stop Screw for 39297.....
1425J 7230	Strip Retainer Spring Holder Hinge Screw
1441C 3778	Feed Cam Driving Worm Set Screw for 18415.....
1442C 3778	Feed Cam Driving Worm Position Screw for 18415.....
1508J 1105	Knife Grinder Emery Wheel Clamping Nut for 60934.....
1508E 3778	Stop Cam Interlocking Rod Case Stop Stud Screw Bushing Lock Nut for 63875
1513J 3724	Oscillating Rock Shaft Hinge Pin Nut for 56812.....
1513J 3724	Oscillating Rock Shaft Hinge Pin Screw Bearing Nut for 5747.....
1516J 1105	Knife Grinder Emery Wheel Shaft Screw Centre Nut for 60583.....
1516J 1105	Knife Grinder Knife Holder Guide Bar Bracket Screw Centre Nut for 60583..
1517E 3776	Knife Bar Cap (intermediate) Stop Pin Screw Bushing Nut for 39263.....
1518E 3718	Crank Connecting Rod Hinge Screw Nut
1518E 3718	Needle Bar Connecting Link Hinge Screw Nut.....
1519E 3702	Oscillating Shaft Crank Slide Block Screw Stud Nut for 15161 and 15162.....
1520E 3724	Arm Shaft Bushing (back) Adjusting Screw Nut.....
1520E 3724	Feed Across Regulator Stop Screw Nut for 63863.....
1520E 3724	Stop Cam Interlocking Rod Case Spring Adjusting Screw Nut for 39344.....
1520E 3724	Stop Cam Interlocking Rod Locking Adjusting Screw Lock Nut for 63877..
1520E 3724	Strip Carrier Lever Stop Screw Nut for 63886.....
1520E 3724	Strip Measuring Bar Nut.....
1522E 3845	Leg Bolt Nut for 51057.....
1522E 3845	" Cross Member Bolt Nut for 51057...
1522E 3845	Rail Bolt Nut for 51057.....
1522E 3845	Treadle Support Bolt Nut for 50297.....
1528J 3778	Feed Across Lever Socket Bearing Block Set Screw Nut, obsolete.....
1560C 3777	Tension Regulating Thumb Nut for 17725

NO. PLATE	NAME
1562J 3781	Bobbin Winder Tension Regulating Thumb Nut for 60770.....
1600R 7230	Treadle Support Bolt Nut for 780, obsolete
1611E 7227	Strip Feed Lever Regulating Screw Stud Nut.....
1620J 3781	Bobbin Winder Frame Hinge Screw Nut for 41713.....
1649C 3714	Feed Across Connection Adjusting Stud Nut (left).....
1650C 3714	Feed Across Connection Adjusting Stud Nut (right).....
1651E 7230	Needle Bar Thread Nipper Rod Adjusting Stud Lock Nut.....
1653C 3724	Feed Cam Shaft Nut for 62264.....
1654C 7230	Knife Cam Lever Roller and Screw Stud Nut for 1980.....
1655C 7224	Feed Regulator Roller and Screw Stud Nut for 1953.....
1662C 3778	Starting Lever Hinge Screw Nut for 63875
1676C 3778	Feed Across Regulator Adjusting Stud Nut
1681C 3778	Knife Bar Driving Lever Hinge Screw Nut
1698C 3778	" Holder Pinion Stud Bracket Screw Nut for 63924.....
1819 3724	Thread Take-up Lever Roller and Stud for 3072.....
1952 3714	Feed Across Lever Roller and Stud for 17729.....
1953 7224	Feed Across Roller and Screw Stud with 1655C and 14017, for 39361.....
1980 3776	Knife Cam Lever Roller and Screw Stud with 1654C, for 39330.....
2002 3777	Arm Dowel Pin.....
2018R 3845	Leg Brace Bolt (lower) Nut Washer for 25291, obsolete.....
2022 3777	Pulley (tight) Pin.....
2049 3702	Oscillating Shaft Crank Pin.....
2049 3702	Shuttle Driver Pin.....
2058 7225	Presser Bar.....
2073 3702	Shuttle Bobbin for 39296.....
*2075 —	" Cover for 44001.....
2076 3702	" " Hinge Pin for 39296.....
2078 3702	" Delivery Eye Thread Guard for 44001.....
2080 3702	Shuttle Delivery Eye Thread Guard Rivet for 44001.....
2082 3702	Shuttle Main Spring for 39295.....
2084 3702	" " " Steady Pin for 39295

NO.	PLATE	NAME
2086	3702	Shuttle Tension Spring for 44001.....
2090	3702	" " " Plate for 44001..
2102	3777	Tension Disc for 17725.....
2103	3777	" Spring for 17725.....
2105	3777	" Thread Guard for 63736.....
2107	3777	Face Plate Thread Guard for 17725.....
2124	3777	Thread Take-up Spring for 17725.....
2127	3777	" " " Regulator Plate for 17725.....
2211	3702	Shuttle Bobbin Retaining Spring for 39295
2212	3702	" " " " Rivet for 39295.....
2269	3777	Pulley (loose) Bushing Position Pin for 17942.....
2455	3781	Bobbin Winder Tension Disc for 60770..
2770	7242	Starting Lever Rock Shaft Stop Dog with 356c, for 63981.....
2809	3718	Table Bracket Machine Holder Connec- tion Hinge Pin for 17875.....
3012	3777	Feed Cam Driving Worm Wheel Pin.....
3012	3777	Stop Cam Pin.....
3012	3777	Thread Take-up Cam Pin.....
3052	3790	Oscillating Rock Shaft Hinge Pin for 56812
3053	7225	" Shaft.....
*3072	7226	Thread Take-up Lever with 1819, for 56855.....
4292	3790	Crank Connecting Rod with 4349 and two 145E.....
*4304	3790	Oscillating Rock Shaft with 4784, for 5747
*4349	—	Crank Connecting Rod Cap for 4292....
4448	3777	Arm Oil Tube for intermediate bearing...
*4449	—	" Shaft Bushing (front) for 39279 and 63989.....
4784	3702	Oscillating Rock Shaft Oil Pad for 4304..
4822	3727	Wrench for 17838 (Attachments and Accessories).....
4879	7231	Chain Hook for 17876 and 63925.....
4879	7231	Motor Treadle Chain Connecting Link for 46616, obsolete.....
4879	7231	Starting Treadle Chain Connecting Link for 46616, obsolete.....
Nos. 4881 to 4883 for 46616, OBSOLETE		
4881	7219	Motor Treadle.....
4881	7219	Starting Treadle.....
4882	7231	Motor Treadle Shaft.....
4882	7231	Starting Treadle Shaft.....

NO.	PLATE	NAME
4883	7231	Motor Treadle Spring.....
4883	7231	Starting Treadle Spring.....
5670	—	Presser Bar Lifting Lever Chain, length 26 in. to 35 in., with 56864 and 56865, for 25285, obsolete.....
5747	—	Oscillating Rock Shaft complete, Nos. 635c, 1513j, 4304 and 56812.....
6439	—	Foot Lifter Chain, 40 in. long, with 56864 and 56865, for 63926.....
6439	—	Starting Lever Chain, 40 in. long, with 56864 and 56865, for 17884.....
6439	—	Starting Lever Chain, length 36 in. to 45 in., with 56864 and 56865, for 25285, obsolete.....
7071	3777	Belt Cover Screw Washer.....
7071	3777	Knife Bar Extension Screw Washer.....
7071	3777	Strip Guide Washer.....
7124	7242	Starting Lever Rock Shaft for 63981.....
7263	3718	Table Bracket Machine Holder Connec- tion for 17875.....
7298	3795	Knife Holder Pinion Dowel Pin for 29269
7476	7224	Feed Plate Carrier Bar Block Steady Pin for 63867.....
8388	7227	Strip Knife (lower) Spring for 63898....
8414	7225	Presser Bar Spring, obsolete, use 32675..
8422	3781	Bobbin Winder Tension Thread Guide for 60770.....
8589	3777	Feed Across Lever Bracket Dowel Pin...
8589	3777	Knife Cam Lever Bracket Dowel Pin...
8589	3777	Strip Carrier Lever Bracket Dowel Pin..
9261	3776	Bed Frame Hinge Connection Pin for 39233.....
9281r	3845	Brace Bolt Nut Washer for 25291, obso- lete.....
9281r	3845	Leg Brace Bracket Bolt Nut Washer for 25291, obsolete.....
9281r	3845	Treadle Support Bolt Nut Washer for 25291, obsolete.....
9320	7227	Strip Clamp Hinge Pin for 63898.....
9525	7227	" Feed Lever Regulating Screw Stud Nut Washer.....
9525	7227	Strip Measuring Plate Screw Washer for 63917.....
9686	7244	Knife Grinder Knife Clamp Position Pin for 126242.....
9780	3781	Bobbin Winder Tension Bracket Position Stud for 60770.....

NUMERICAL LIST OF PARTS

NO.	PLATE	NAME
9842	3845	Leg Brace Bolt (upper) Bolt Washer for 25291, obsolete.....
10875	3727	Wrench for 1518 and 1520 (Attachments and Accessories).....
11831	7231	Screw Driver, large (Attachments and Accessories).....
12424	3702	Oscillating Shaft Crank Slide Block Cap Screw Washer for 15171.....
12620	3845	Leg Bolt Washer for 126758.....
12620	3845	" Cross Member Bolt Washer for 126758.....
12620	3845	Rail Bolt Washer for 126758.....
12620	3845	Treadle Support Bolt Washer for 46712..
13211	7229	Tape Holder Tension Adjusting Spring for 120323.....
14017	7224	Feed Regulator Roller and Screw Stud Nut Washer for 1953.....
14079	7220	Arch Clamp Frame Dowel Pin for 63859.....
14224	—	Starting Lever Rock Shaft Chain, length 10¼ in., with 56864, for 63981.....
*15160	—	Oscillating Shaft Crank for 15161.....
*15161	—	Oscillating Shaft Crank complete, Nos. 462c, 1519e, 15160 and 15171.....
15162	3702	Oscillating Shaft Crank complete, Nos. 1519e, 15171, 15425 and two 462c....
15170	3702	Oscillating Shaft Crank Slide Block for 15171.....
15171	3702	Oscillating Shaft Crank Slide Block complete for 15161 and 15162, Nos. 226d, 1035c, 12424 and 15170.....
15425	—	Oscillating Shaft Crank for 15162.....
16128	7242	Starting Lever Rock Shaft Hanger with two wood screws 1 in. No. 10, for 63981.....
16532	3777	Stop Cam Interlocking Rod Case Bracket Dowel Pin.....
17702	3728	Arm Shaft.....
17703	7222	" " Bushing (back).....
17724	3790	Face Plate for 63736.....
17725	—	Face Plate complete, Nos. 448c, 600c, 1560c, 2103, 2107, 2124, 2127, 63736 and two each 233b and 2102.....
17726	3714	Feed Across Connection Adjusting Stud
17727	3714	" " Knuckle Joint, obsolete....
17728	3714	" " " " Connection, obsolete.....
17729	3790	Feed Across Lever with 1185c and 1952
17730	3714	" " " Ball Stud, obsolete....

NUMERICAL LIST OF PARTS

NO.	PLATE	NAME
17733	3714	Feed Across Lever Socket Bearing, obsolete.....
17734	3714	Feed Across Lever Socket Bearing, Block (two pieces) obsolete.....
17737	3714	Feed Across Lever Hinge Stud.....
17738	7220	" " Regulator Adjusting Stud Nut Washer.....
17739	7220	Feed Across Regulator Adjusting Stud Sleeve, obsolete.....
17741	7220	Belt Cover Bracket Stud for 39290.....
17741	7220	Feed Across Regulator Link Stud for 63862.....
17744	7224	Feed Regulator Hinge Stud.....
17746	3719	Shuttle Race Back with 17747, for 63815
17747	3719	" " " Thread Guard Pin for 17746.....
17749	7228	Throat Plate Extension for 63922.....
17750	—	Knife Bar Extension 17820 with 17821 and two 17822.....
17797	3790	Feed Cam Driving Worm Wheel with 453c, for 62264.....
17802	7224	Feed Plate Carrier Bar Block for 63867..
17805	3714	" " " " Pivot Block.....
17807	3794	Knife (needle thread) for 39488.....
17808	3794	" (shuttle thread) for 39488.....
17810	3794	" Bar Cap (back).....
17811	3794	" " " (front).....
17814	3794	" " Connection Rivet for 63807...
Nos. 17820 to 17822 FOR 17750		
17820	3795	Knife Bar Extension.....
17821	3795	" " Rack.....
17822	3795	" " " Rivet.....
17826	3795	" Holder Pinion for 39269.....
17827	3795	" " " Stud for 39270.....
17829	3795	" Thread Holder for 39488.....
17830	3795	" " " Position Pin for 39269.....
17831	7222	Needle Bar with 237F.....
17834	3718	" " Thread Nipper Lever with 17835.....
17835	3718	Needle Bar Thread Nipper Lever Bushing for 17834.....
17837	7222	Needle Bar Thread Nipper Rod.....
17838	3718	" " " " " Adjusting Stud.....

NUMERICAL LIST OF PARTS

NO.	PLATE	NAME
17839	3718	Needle Bar Thread Nipper Rod Arm with 196r.....
17840	7222	Needle Bar Thread Nipper Rod Support
17841	3718	Presser Bar Collar with two 196r.....
17842	3718	" " Guide Bracket with 453c....
17844	7225	" " Lifting Bell Crank Bracket for 39279, for 63989.....
17848	7225	Pulley (loose) Bushing for 17955.....
17853	7225	Starting Lever for 63875.....
17854	3721	Stop Cam for 17955.....
17855	3721	" " Interlocking Rod for 39405....
17859	7225	" " " " Case Socket Joint for 63875.....
17861	3721	Stop Cam Interlocking Rod Case Stop Stud for 63875.....
17862	3721	Stop Cam Interlocking Rod Case Stop Stud Spring for 63875.....
17863	3721	Stop Cam Interlocking Rod Spring for 39405.....
17864	3721	Stop Cam Interlocking Rod Stop for 39405
17865	7229	Thread Wiper Body.....
17866	7229	" " " Hook for 17958.....
17867	7229	" " " Support.....
17868	7229	" " " Wire.....
17869	7229	" " " " Screw Washer.
17872	3721	Trip Lever for 63875.....
17873	3721	" " Spring for 63875.....
17874	7229	Tripping Point for 39430.....
17875	3728	Table Bracket Machine Holder with 2809, 7263, 39484 and two wood screws 1¼ in. No. 10 (Attachments and Accessories)
17876	3728	Starting Lever Treadle with 443c, for 17884.....
17881	7231	Foot Lifter Treadle Shaft for 63926.....
17881	7231	Starting Lever Treadle Shaft for 17884..
17882	3718	Foot Lifter Treadle Spring for 63926.....
17882	3718	Starting Lever Treadle Spring for 17884..
17883	3728	Foot Lifter Treadle Stand for 63926....
17883	3728	Starting Lever Treadle Stand for 17884..
17884	—	Starting Lever Treadle complete, Nos. 17876, 17881 to 17883 and two wood screws 1 in. No. 10.....
17886	7225	Starting Lever Pitman.....
17892	3728	Table Belt Guide Bracket with two 153E, for 39221.....
17893	3728	Table Belt Guide Pulley for 39221.....

NUMERICAL LIST OF PARTS

NO.	PLATE	NAME
17896	3718	Table Belt Guide Pulley Shaft Plug for 39219 and 39220.....
17905	3727	Wrench for 1654, 1655 and 1676 (Attachments and Accessories).....
17915	3794	Knife Bar Connection Slide Block for 63809.....
17919	3794	Knife Bar Driving Lever Lock Stud Spring for 39297.....
17941	3774	Pulley (loose) 2½ in. Diam., for 17955, obsolete, use, 63975.....
17942	3774	Pulley (tight) 2½ in. diam., with 2269, for 17955.....
17955	—	Pulleys complete, Nos. 1202a, 1206c, 17848, 17854, 17941 and 63975.....
17958	7220	Arch Clamp Foot Lifter with 17866.....
17959	7220	" " " Lifting Stud for 63856.
18368	3714	Feed Plate Carrier Bar Plate for 63867..
18384	3777	" Cam Pin.....
18415	7222	" " Driving Worm with 1441c and 1442c.....
18416	7222	Feed Cam Shaft, obsolete.....
18417	7222	" " Bracket, obsolete.....
18443	7224	Stop Cam Interlocking Rod Case Wearing Block for 39345 and 63978.....
18471	3776	Knife Cam Lever Hinge Screw Bushing for 18472.....
*18472	—	Knife Cam Lever Hinge Screw Bushing 18471 with 50029c.....
18488	7221	Feed Regulator Post for 63867.....
18489	7224	" " " Guide.....
18498	7223	Belt Cover.....
19793	3777	Knife Bar Stop Block Dowel Pin for 39329
19793	3777	" Cam Lever Slide Steady Pin.....
21629	3718	Needle Bar Connecting Stud with 155c, for 63756.....
22003	3727	Wrench for 1651 (Attachments and Accessories).....
23483	7224	Presser Bar Lifting Bell Crank Spring...
25086	7231	Wrench for 25285, obsolete.....
25127	7229	Belt Hook for 25490, obsolete.....
25285	—	Stand (iron work) complete, for Electric Motor, Nos. 25086, 46618, 46667, two each 780R, 82973 and four 748R, obsolete, use 25391.....

NUMERICAL LIST OF PARTS

NO.	PLATE	NAME
25291	—	Stand (iron work) complete, for 1/8 H. P. Electric Transmitter, Nos. 46673, 46676, 46677, 46683, two each 2018R, 9842R, 46674, 46675, 51083R, 51088R, four 67425 and eight each 9281R and 51009R, obsolete.....
25297	—	Stand (steel work) complete, for Singer Individual and 1600 Series Motors, Nos. 46711 and two each 46707, 46712 and 126578.....
25490	—	Belt, size 1/4 in., length 36 in., with 25127, for 25285, obsolete.....
26026	3727	Screw Driver, medium (Attachments and Accessories).....
26064	7232	Tape Holder Foot with 736B and three wood screws 1 in. No. 10, for 120324....
26069	—	Tape Holder Disc Hub for 26916.....
26070	7229	" " " " Rivet for 26916..
26073	7229	" " Tension Adjusting Collar with 286B, for 120323.....
26459	7227	Strip Carrier Rivet for 63880.....
26485	3727	Screw Driver (small) Attachments and Accessories.....
26914	7232	Tape Holder Disc for 26916 and 120322..
26916	—	Tape Holder Disc complete for 120323, Nos. 26069, 26914 and three 26070....
26918	7232	Tape Holder Tape Guide for 120322.....
27305	3781	Bobbin Winder Spindle for 41713.....
27321	3781	" " Frame for 41713.....
27323	1105	Knife Grinder Knife Holder Guide Bar for 60583.....
27326	3781	Bobbin Winder Stop Latch for 41713....
27564	1104	Knife Grinder Frame with 27574, for 60583
27565	1104	" " Emery Wheel, 2 in. diam., for 60934.....
27567	1105	Knife Grinder Emery Wheel Shaft for 60934.....
27568	1105	Knife Grinder Emery Wheel Shaft Oil Hole Cover (leather) for 60583.....
27569	1105	Knife Grinder Emery Wheel Shaft Pulley for 60934.....
27572	1104	Knife Grinder Knife Holder Guide Bar Bracket with 27574, for 60583.....
27573	1105	Knife Grinder Knife Holder Guide Bar Bracket Spring for 60583.....

NUMERICAL LIST OF PARTS

NO.	PLATE	NAME
27574	1105	Knife Grinder Knife Holder Guide Bar Bracket Spring Hook for 27564 and 27572.....
27659	1105	Knife Grinder Knife Holder Stop Collar with 237K, for 60583.....
27662	1104	Wrench for 1508 and 1516, for 126244....
27662	3727	" " 1254 and 1508 (Attachments and Accessories).....
27683	7242	Starting Lever Rock Shaft Arm with two 356c, for 63981.....
27739	7234	Thread Unwinder Thread Cone (wood) for large cones.....
27822	1105	Knife Grinder Emery Wheel Clamping Nut Washer for 60934.....
27916	3781	Bobbin Winder Brake (leather) for 41598
27929	7244	Knife Grinder Knife Clamp Thumb Screw Spring for 126243.....
28084	3781	Bobbin Winder Brake Rivet for 41598..
28094	7224	Strip Knife (upper) Bell Crank Pitman Set Screw Extension Pin.....
32675	7245	Presser Bar Spring.....
*39203	3718	Needle Bar Connecting Link for 63756...
39204	3790	Thread Take-up Cam 63749 with 446c...
Nos. 39218 to 39220 FOR 39221		
39218	3728	Table Belt Guide Belt Guide with two 168E.....
39219	3728	Table Belt Guide Pulley Shaft (long) with 17896 and 63973.....
39220	3728	Table Belt Guide Pulley Shaft (short) with 17896 and 63974.....
39221	—	Table Belt Guide complete, Nos. 17892, 39219, 39220, two each 17893, 39218 and three wood screws 1 1/4 in. No. 12..
39222	3774	Belt Shifter for 39405.....
39223	3776	" " Clamp for 39405, obsolete...
39232	3749	Bed Frame Side Cover for 39233.....
39233	3749	" " with 39232, two each 9261, 39325, 39483 and four wood screws 1 1/4 in. No. 12.....
39234	3750	Drip Pan for 39233.....
39235	7222	Knife Cam Lever Body for 39409.....
39262	3776	" Bar Cap (intermediate) for 39263..
39263	—	" " " " 39262 with 1328E, 1517E, 39264 and 39265.....
39264	3776	Knife Bar Cap (intermediate) Stop Pin for 39263.....

NUMERICAL LIST OF PARTS

NO.	PLATE	NAME
39265	3776	Knife Bar Cap (intermediate) Stop Pin Spring for 39263.....
39269	3795	Knife Holder with 1336c, 17826, 17830 and two 7298, for 39488.....
39270	3795	Knife Holder Pinion Stud Bracket with 17827, for 63924.....
39276	3776	Needle Bar Thread Nipper Lever Spring
39277	3795	Knife Thread Retainer Finger for 39291.
39278	3795	" " " " Rivet for 39291.....
*39279	—	Arm with 4449, 17844 and two 164e, obsolete.....
39290	3774	Belt Cover Bracket with 184e and 17741
39291	3795	Knife Thread Retainer with 39277 and two 39278, for 63924.....
*39295	—	Shuttle Body with 398e, 2082, 2084, 2211 and two 2212, for 39296.....
39296	3702	Shuttle complete, Nos. 2073, 2076, 39295 and 44001.....
39297	3794	Knife Bar Driving Lever with 190d, 1420e, 17919 and 39298.....
39298	3794	Knife Bar Driving Lever Lock Stud for 39297.....
39299	3774	Knife Bar 63807 with 704c and 39300....
39300	3776	" " Stop Block for 39299.....
39303	7220	Arch Clamp Foot Shank Spring for 63859
39309	3790	Feed Across Lever Bracket with 39310 and three 160d.....
*39310	—	Feed Across Lever Bracket Cap for 39309
39313	3794	" Regulator Swivel.....
39325	3776	Bed Frame Hinge Connection for 39233
39329	7222	Knife Cam Lever complete, Nos. 19793 and 39409.....
39330	3776	Knife Cam Lever Slide with 1980, for 39460.....
39331	3776	Knife Cam Lever Slide Screw Washer for 39460.....
39332	3774	Knife Cam Lever Bracket with 1177d....
39343	3774	Stop Cam Interlocking Rod Case Spring (flat) for 63876.....
39344	3776	Stop Cam Interlocking Rod Case Spring Bracket with 1520e and 50682c, for 63876.....
39345	7225	Stop Cam Interlocking Rod Case 63945 with 18443 and two 193d, for 39405, obsolete, use 63993.....

NUMERICAL LIST OF PARTS

NO.	PLATE	NAME
39350	7222	Needle Bar Thread Nipper Driving Lever (adjustable) with 39351 and two 335d
39351	3776	Needle Bar Thread Nipper Driving Lever Extension for 39350.....
39352	7222	Needle Bar Thread Nipper Driving Lever Spring.....
39361	7222	Feed Regulator with 1953.....
*39405	—	Stop Cam Interlocking Rod Case 63993 with 1318d, 17855, 17863, 17864 and 39222, for 63875.....
39428	7222	Feed Across Regulator.....
39429	7220	" " " Link.....
39430	3791	" Cam with 17874 and two each 190d and 1192c.....
39460	—	Knife Cam Lever Slide 39330 with 1255d and 39331, for 39409.....
39483	3777	Bed Frame Cushion (leather) for 39233..
39484	3718	Table Bracket Machine Holder Cushion (leather) for 17875.....
39487	3702	Shuttle Driver with two 457c.....
*39488	—	Knife Holder 39269 with 1198c, 17807, 17808 and 17829, for 63924.....
41401	7231	Machine Rest Pin, wood (Attachments and Accessories).....
41598	3780	Bobbin Winder Base with 27916 and two 28084, for 41713.....
41600	3780	Bobbin Winder Pulley with 155c, for 41713.....
41713	3780	Bobbin Winder Nos. 35d, 1620j, 27305, 27321, 27326, 41598, 41600, 41825 and 50356, for 41714.....
41714	—	Bobbin Winder (swinging automatic, left hand) complete, Nos. 161d, 41713, 60770 and two 1186c.....
41825	3781	Bobbin Winder Frame Spring for 41713..
*42076	—	Feed Across Connection Cap for 63940 and 63942.....
43804	7224	Strip Knife (upper) Bell Crank Pitman Stud Collar with 1253c.....
43808	3781	Bobbin Winder Tension Spring for 60770
*44001	—	Shuttle Cover 2075 with 112d, 466h, 2078, 2080, 2086 and 2090, for 39296.....
46244	7244	Feed Across Regulator Adjusting Screw Stud Nut Washer (fibre).....
46614	7219	Motor Treadle Bracket (left) for 46616, obsolete.....

NUMERICAL LIST OF PARTS

NO.	PLATE	NAME
46614	7219	Starting Treadle Bracket (left) for 46616, obsolete.....
46615	7219	Motor Treadle Bracket (right) for 46616, obsolete.....
46615	7219	Starting Treadle Bracket (right) for 46616, obsolete.....
46616	7219	Motor Treadle complete for 46618, Nos. 4879, 4881 to 4883, 46614 and 46615, obsolete.....
46616	7219	Starting Treadle complete for 46618, Nos. 4379, 4881 to 4883, 46614 and 46615, obsolete.....
46617	7219	Treadle Support for 46618, obsolete.....
46618	—	“ “ 46617 with two 46616 and four 1177E, for 25285, obsolete....
46667	7219	Brace for 25285, obsolete.....
Nos. 46673 TO 46677 FOR 25291, OBSOLETE		
46673	7241	Brace.....
46674	7241	Leg.....
46675	7241	“ Brace.....
46676	7242	“ “ Bracket (left).....
46677	7242	“ “ “ (right).....
46683	7241	Treadle Support for 25291, obsolete.....
46707	9090	Leg Brace with wood screw 1 in. No. 16, for 25297.....
46711	9090	Treadle Support for 25297.....
46712	—	“ “ Bolt 50297R with 12620 and 46713, for 25297.....
46713	7246	Treadle Support Packing for 46712.....
49109	7220	Arch Clamp Foot Screw Washer for 63859
49109	7220	Strip Feed Lever Connection (right) Screw Washer for 63895.....
50008J	7220	Arch Clamp Foot Shank Spring (upper) for 63859.....
50018F	3778	Knife Holder Pinion Stud Bracket Screw for 63924.....
50029c	3776	Knife Cam Lever Hinge Screw for 18472.
50076K	7227	Strip Feed Plate Connecting Link Hinge Screw.....
50131c	7230	Strip Carrier Lever Screw Stud.....
50166E	7244	Strip Knife (upper) Bell Crank Spring Screw Stud.....
50269F	7230	Feed Regulator Screw.....
50297R	3842	Treadle Support Bolt with 1522E, for 46712.....

NUMERICAL LIST OF PARTS

NO.	PLATE	NAME
50333c	7230	Arm Shaft Bushing (back) Adjusting Screw.....
50356D	3781	Bobbin Winder Frame Hinge Screw for 41713.....
50384E	7230	Stop Cam Interlocking Rod Locking Lever Adjusting Screw for 63877.....
50406D	7228	Throat Plate Extension Screw for 63922
50411J	7227	Strip Clamp Hinge Bearing Screw for 63898.....
50470J	7224	Feed Plate Strip Spring Screw for 63865
50471E	7227	Strip Feed Lever Regulating Screw Stud
50599D	7244	Feed Across Regulator Adjusting Screw Stud.....
50682c	7244	Stop Cam Interlocking Rod Case Spring Adjusting Screw for 39344.....
51009R	3842	Brace Bolt with 51571R, for 25291, obsolete
51009R	3842	Leg Brace Bracket Bolt with 51571R, for 25291, obsolete.....
51009R	3842	Treadle Support Bolt with 51571R, for 25291, obsolete.....
51057R	3842	Leg Bolt with 1522E, for 126758.....
51057R	3842	“ Cross Member Bolt with 1522E, for 126758.....
51057R	3842	Rail Bolt with 1522E, for 126758.....
51083R	3842	Leg Brace Bolt (upper) with 51581R, for 25291, obsolete.....
51088R	3842	Leg Brace Bolt (lower) with 51581R, for 25291, obsolete.....
51571R	7245	Brace Bolt Nut for 51009, obsolete.....
51571R	7245	Leg Brace Bracket Bolt Nut for 51009, obsolete.....
51571R	7245	Treadle Support Bolt Nut for 51009, obsolete.....
51581R	7245	Leg Brace Bolt (lower) Nut for 51088, obsolete.....
51581R	7245	Leg Brace Bolt (upper) Nut for 51083, obsolete.....
55381	7244	Feed Across Connection (lever end) Ball Stud for 63941.....
56812	—	Oscillating Rock Shaft Hinge Pin 3052 with 1513J, for 5747.....
56855	—	Thread Take-up Lever 3072 with 1088c..
56864	7231	Chain Hook (large) for 5670 and 6439...
56864	7231	Starting Lever Rock Shaft Chain Hook for 14224.....
56865	7229	Chain Hook (small) for 5670 and 6439...
60769	3780	Bobbin Winder Tension Bracket for 60770

NUMERICAL LIST OF PARTS

NO.	PLATE	NAME
60770	3780	Bobbin Winder Tension Bracket complete for 41714, Nos. 419E, 1562J, 8422, 9780, 43808, 60769 and two 2455.....
60583	5918	Knife Grinder for 126244, Nos. 261J, 27323, 27564, 27572, 27573, 27659, 60934, two 27568 and four each 310K and 1516J
60934	—	Knife Grinder Emery Wheel Shaft 27567 with 1508J, 27565, 27569 and 27822, for 60583.....
62155	7246	Feed Cam Shaft for 62264.....
62264	—	" " 62155 with 1653c and 17797.....
*63736	—	Face Plate 17724 with 3105, for 17725...
*63749	—	Thread Take-up Cam for 39204.....
63756	—	Needle Bar Connecting Link 39203 with 21629.....
*63806	—	Knife Bar for 63807.....
63807	—	" " 63806 with 63808, 63809 and two 17814, for 39299.....
63808	7224	Knife Bar Connection for 63807.....
63809	—	" " " Slide Block 17915 with 63810, for 63807.....
63810	7224	Knife Bar Connection Slide Block Stud for 63809.....
63814	—	Shuttle Race Body for 63815.....
63815	3719	Shuttle Race complete, Nos. 17746, 63814 and two 190c.....
Nos. 63855 to 63858 for 63859		
63855	7220	Arch Clamp Foot.....
63856	7220	" " " Shank with 17959.....
63857	7220	" " " " Plate.....
63858	7221	" " " Frame.....
63859	—	Arch Clamp complete, Nos. 225K, 1209K, 39303, 49109, 50008J, 63855 to 63858, 63865, 63867, two each 181D, 14079 and five 217J.....
*63860	—	Bed.....
63861	7223	" Cover.....
63862	7222	Feed Across Plate with 17741.....
63863	7222	" " Regulator Stop Screw Bracket with two each 717C and 1520E.....
63864	7221	Feed Plate for 63865.....
63865	—	Feed Plate complete for 63859, Nos. 63864, 63868 to 63871 and four each 707J and 50470J.....
63866	7221	Feed Plate Carrier Bar for 63867.....

NUMERICAL LIST OF PARTS

NO.	PLATE	NAME
63867	—	Feed Plate Carrier Bar 63866 with 934D, 17802, 18368, 18488, 63921 and two 7476, for 63859.....
Nos. 63868 to 63871 for 63865		
63868	7224	Feed Plate Strip Folder (left).....
63869	7224	" " " " (right).....
63870	7224	" " " Spring (left).....
63871	7224	" " " " (right).....
63872	7225	Presser Bar Lifting Bell Crank.....
63873	7224	" " " " " Connecting Link.....
63874	7225	Stop Cam Interlocking Rod Case Bracket for 63875.....
63875	—	Stop Cam Interlocking Rod Case Bracket complete for 63876, Nos. 1182E, 1196C, 1204C, 1254C, 1262C, 1508E, 1662C, 17853, 17859, 17861, 17862, 17872, 17873, 39405, 63874 and two 898D....
63876	—	Stop Cam Interlocking Rod Case Bracket 63875 with 39343, 39344 and two 1186D
63877	7225	Stop Cam Interlocking Rod Locking Lever with 1520E and 50384E.....
63878	7225	Stop Cam Interlocking Rod Locking Lever Connection.....
63879	7226	Strip Carrier for 63880.....
63880	7226	Strip Carrier complete, Nos. 63879, 63881 to 63884, two 26459 and four each 185J and 120299.....
Nos. 63881 to 63884 for 63880		
63881	7226	Strip Carrier Plate.....
63882	7226	" " " Bar (left).....
63883	7226	" " " " (right).....
63884	7226	" " " " Block.....
63885	7226	" " " Lever.....
63886	7226	" " " Bracket with 430C and 1520E.....
63887	7224	Strip Carrier Swivel.....
63888	7226	" Cover for 63916.....
Nos. 63889 to 63891 for 63898		
63889	7227	Strip Clamp.....
63890	7227	" " Hinge Bearing.....
63891	7227	" Feed Awl.....
63892	7226	" " Lever.....

NUMERICAL LIST OF PARTS

NO.	PLATE	NAME
63893	7227	Strip Feed Lever Connection (left) for 63895.....
63894	7227	Strip Feed Lever Connection (right) for 63895.....
63895	—	Strip Feed Lever Connection complete, Nos. 191c, 49109, 63893 and 63894....
63896	7227	Strip Feed Lever Stop.....
63897	7221	" " Plate with two 63903, for 63898
63898	—	Strip Feed Plate complete, Nos. 206D, 1097F, 8358, 9320, 63889, 63891, 63897, 63900, 63901, 63907 to 63910 and two each 665J, 707J, 1019c, 1253c, 5041LJ and 63890.....
63899	7227	Strip Feed Plate Connecting Link.....
63900	7227	" " " Cover for 63898.....
63901	7227	" " " Extension for 63898....
63902	7227	" " " Gib.....
63903	7227	" " " Pin for 63897.....
63904	7221	" Guide (lower).....
63905	7221	" (upper).....
63906	7221	" " Bracket.....
Nos. 63907 to 63910 FOR 63898		
63907	7227	Strip Knife (lower).....
63908	7227	" " (upper).....
63909	7227	" " " Bell Crank.....
63910	7227	" " " " " Hinge Stud.....
63911	7221	Strip Knife (upper) Bell Crank Pitman
63912	7224	" " " " " " Stud.....
63913	7224	Strip Knife (upper) Bell Crank Pitman Stud Bushing.....
63914	7226	Strip Measuring Bar.....
63915	7223	" " Plate for 63916.....
63916	—	" " " 63915 with 658J, 63888 and two 665J, for 63917.....
63917	—	Strip Measuring Plate 63916 with two each 9525 and round head wood screws 1 in. No. 10.....
63918	7226	Strip Retaining Spring for 63920.....
63919	7226	" " " Holder for 63920.
63920	7226	" " " " 63919 with 63918 and two 707J.....
63921	7224	Strip Retaining Spring Holder Stud for 63867.....

NUMERICAL LIST OF PARTS

NO.	PLATE	NAME
63922	7228	Throat Plate with 17749, 63923 and two each 1208E and 50406D, for 63924.....
63923	7228	Throat Plate Needle Hole Bushing for 63922.....
63924	—	Throat Plate 63922 with 1698c, 39270, 39291, 39488 and 50018F.....
63925	7223	Foot Lifter Treadle with 443c, for 63926
63926	7223	Foot Lifter Treadle complete, Nos. 17881 to 17883, 63925 and two wood screws 1 in. No. 10.....
63940	7244	Feed Across Connection (lever end) with 42076 and two 896E, for 63941.....
63941	—	Feed Across Connection (lever end) 63940 with 55381.....
63942	7244	Feed Across Connection (regulator end) with 42076 and two 896E, for 63943....
63943	—	Feed Across Connection (regulator end) 63942 with 63944.....
63944	7244	Feed Across Connection (regulator end) Ball Stud for 63943.....
63973	7246	Table Belt Guide Pulley Shaft (long) Wick (braided cotton) for 39219.....
63974	7246	Table Belt Guide Pulley Shaft (short) Wick (braided cotton) for 39220.....
63975	7246	Pulley (loose) 2¾ in. diam., for 17955...
63976	7244	Belt Shifter Clamp for 63993.....
63977	7246	Stop Cam Interlocking Rod Case for 63978.....
63978	—	Stop Cam Interlocking Rod Case 63977 with 18443 and two 193D.....
63981	—	Starting Lever Rock Shaft complete for 25291 and 25297, Nos. 2770, 7124, 14224 and two each 16128 and 27683.....
63982	7244	Strip Knife (upper) Bell Crank Spring...
*63989	—	Arm with 4449, 17844 and two 164E.....
63993	—	Stop Cam Interlocking Rod Case 63978 with 63976 and two 1255D, for 39405...
67425	3845	Leg Brace Bolt (lower) Nut Lock Washer for 25291, obsolete.....
67425	3845	Leg Brace Bolt (upper) Nut Lock Washer for 25291, obsolete.....
82973	7219	Leg for 25285, obsolete.....
120299	7227	Strip Carrier Plate Rivet for 63880.....
120321	7232	Tape Holder Bracket Wire for 120322...
120322	—	Tape Holder Bracket Wire complete for 120323, Nos. 26914, 26918 and 120321

NO.	PLATE	NAME
120323	7232	Tape Holder (straight 6 in disc) complete, for 120324, Nos. 13211, 26073, 26916 and 120322.....
120324	—	Tape Holder with Foot complete, Nos. 26064 and 120323.....
120346	4079	Oiler (copper plated) with 120347 (Attachments and Accessories).....
120347	4079	Oiler Spout, 9 in. long, for 120346.....
124674	7245	Arm Side Cover.....
126241	7245	Knife Grinder Knife Clamp for 126243....
126242	7245	“ “ “ “ Holder with 9686....
126243	—	Knife Grinder Knife Holder complete for 126244, Nos. 732J, 27929, 126241 and 126242.....
126244	—	Knife Grinder complete for 63907 and 63908, Nos. 27662, 60583, 126243 and three wood screws 1 in. No. 10.....
126508	9090	Leg for 126758.....
126509	7245	“ Bolt Nut Socket Washer for 126758.
126509	7245	“ Cross Member Bolt Nut Socket Washer for 126758.....
126509	7245	Rail Bolt Nut Socket Washer for 126758
126530	9090	Leg Cross Member, 15½ in. long, for 126758.....
126532	9090	Rail, 16 in. long, for 126758.....
126758	—	Leg with Rail complete, for 25297, Nos. 126530, 126532, two 126508, three 12620 and four 51057R and 126509.....
200383c	7229	Thread Unwinder Spool Rest Rod Set Screw for 202490.....
201018c	7229	Thread Unwinder Spool Rest Set Screw for 225395.....
201696J	7229	Thread Unwinder Thread Guide Lock Nut for 225396.....
202490	7233	Thread Unwinder Spool Stand with 200383c, for 225396.....
225388	7233	Thread Unwinder Spool Rest Rod for 225396.....
		Nos. 225390 to 225392 FOR 225396
225390	7234	Thread Unwinder Thread Cone Holder for inverted cones.....
225391	7233	Thread Unwinder Thread Guide.....
225392	7233	“ “ “ “ Rod with 208E and 225393.....
225393	7229	Thread Unwinder Thread Guide Rod Washer for 225392.....

NO.	PLATE	NAME
225395	7233	Thread Unwinder Spool Rest with 201018c, for 225396.....
225396	7233	Thread Unwinder complete for two spools, Nos. 201696J, 202490, 225388, 225392, 225395, two 225391 and three wood screws 7/8 in. No. 12.....

Genuine Singer Needles and their Containers are marked with the Company's Trade Mark "SIMANCO." 1

Needles in Containers marked "For Singer Machines" are not Singer made needles. 2

PLATE 1104—ONE-HALF SIZE

27564

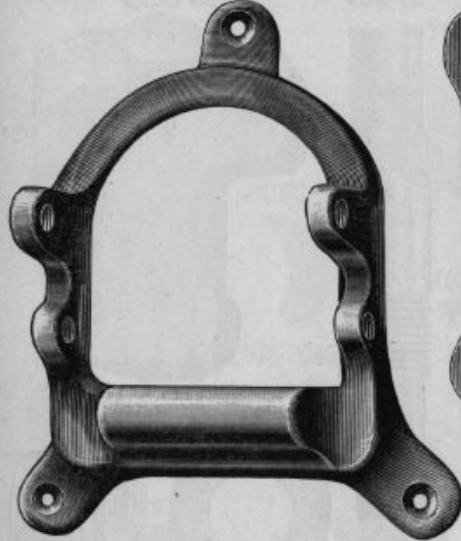

27662

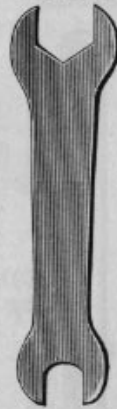

27572

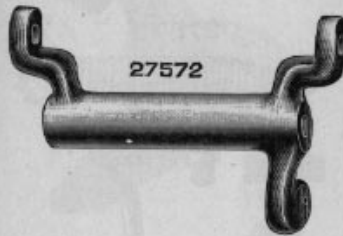

27565



PLATE 1105—FULL SIZE

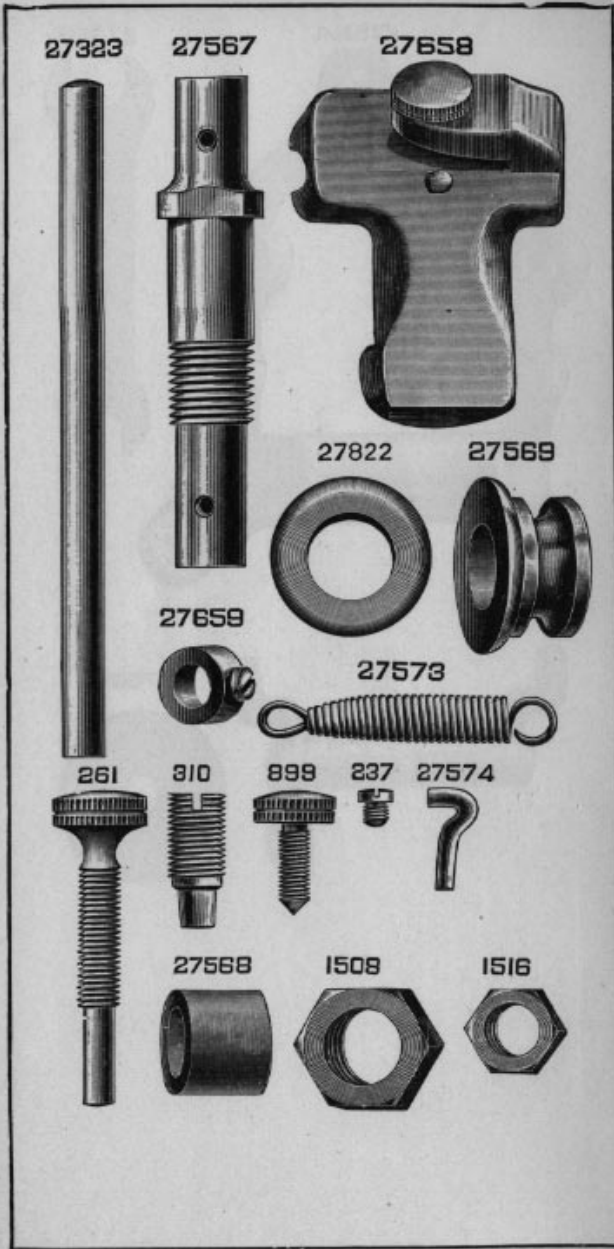

PLATE 3702—FULL SIZE

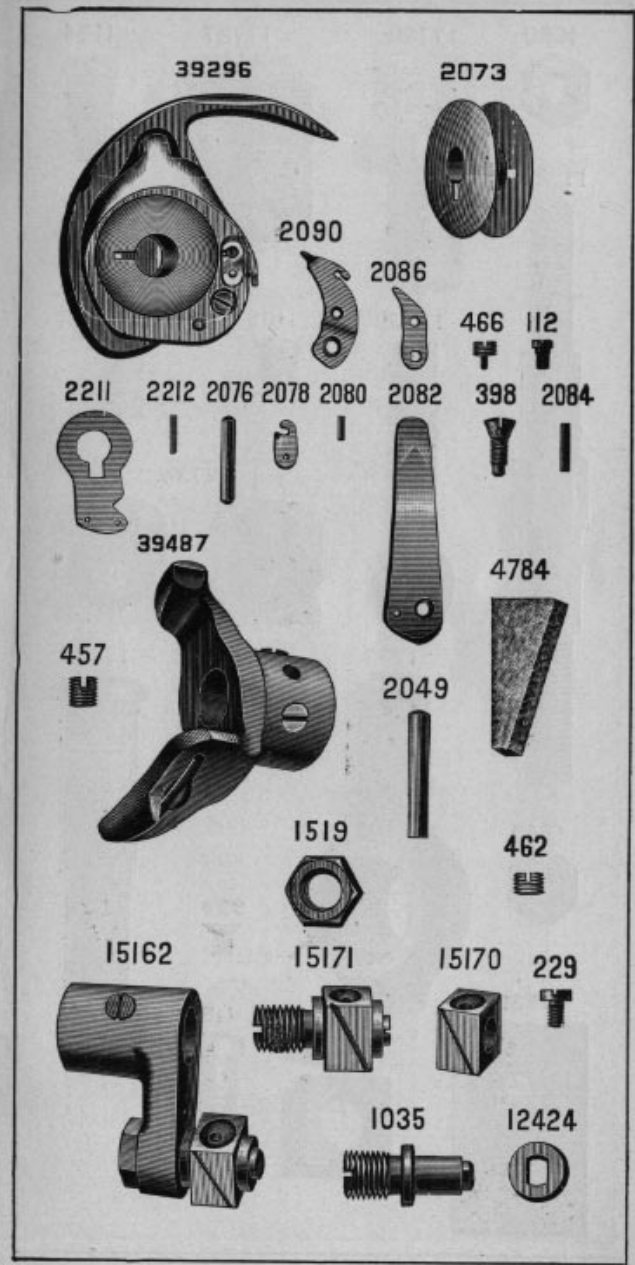

PLATE 3714—FULL SIZE

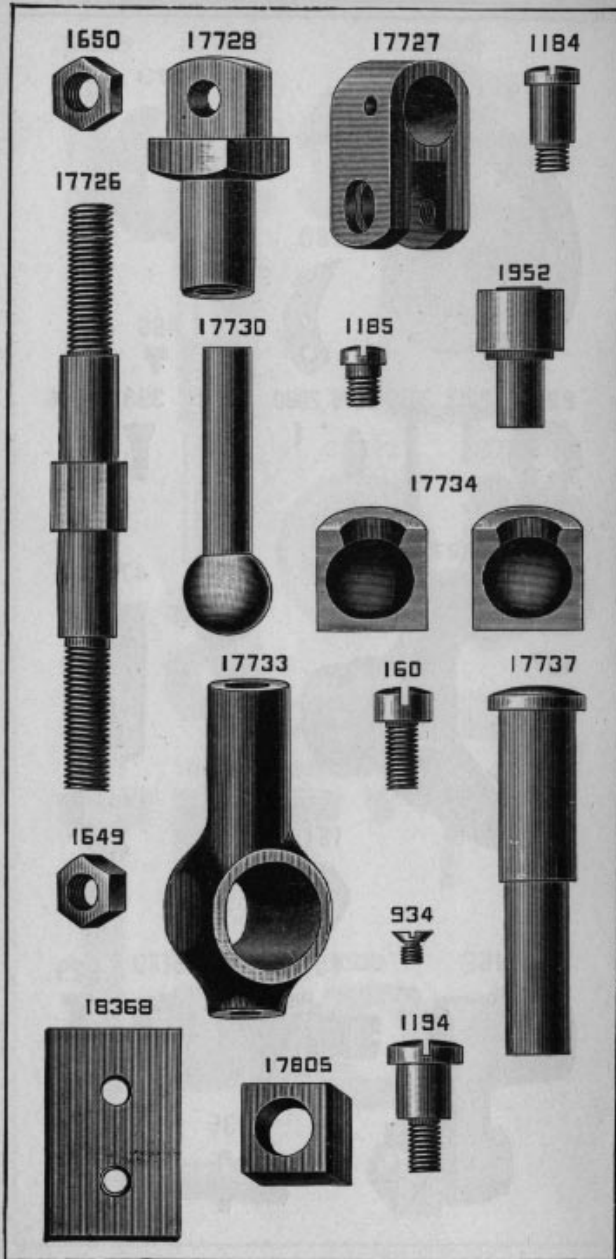

PLATE 3718—FULL SIZE

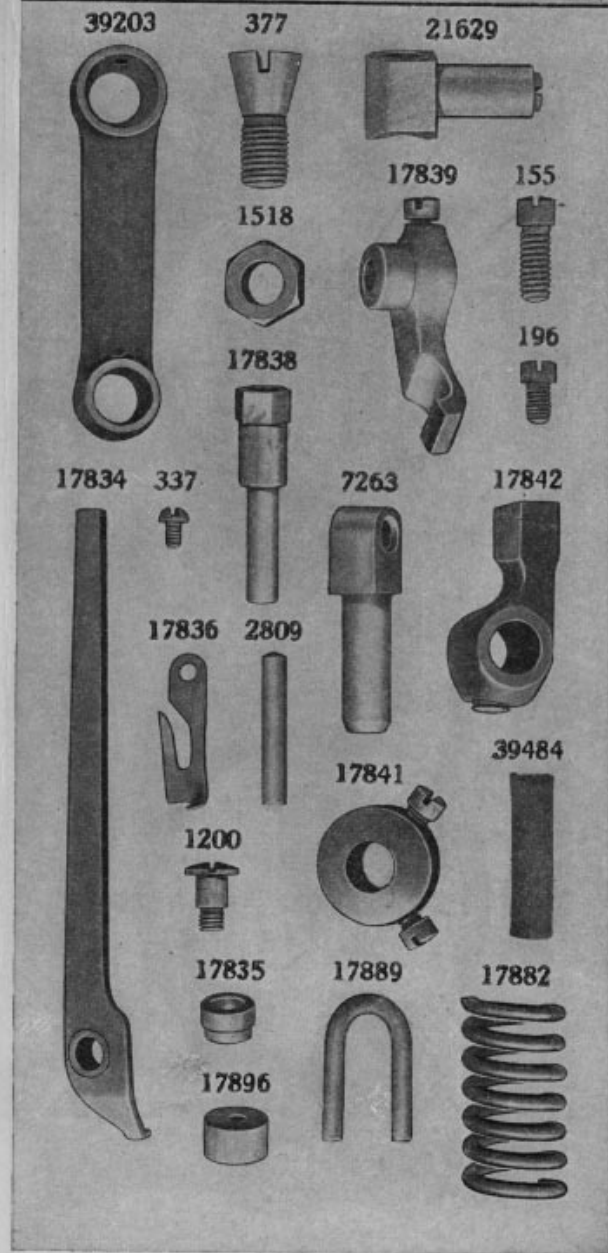

PLATE 3719—FULL SIZE

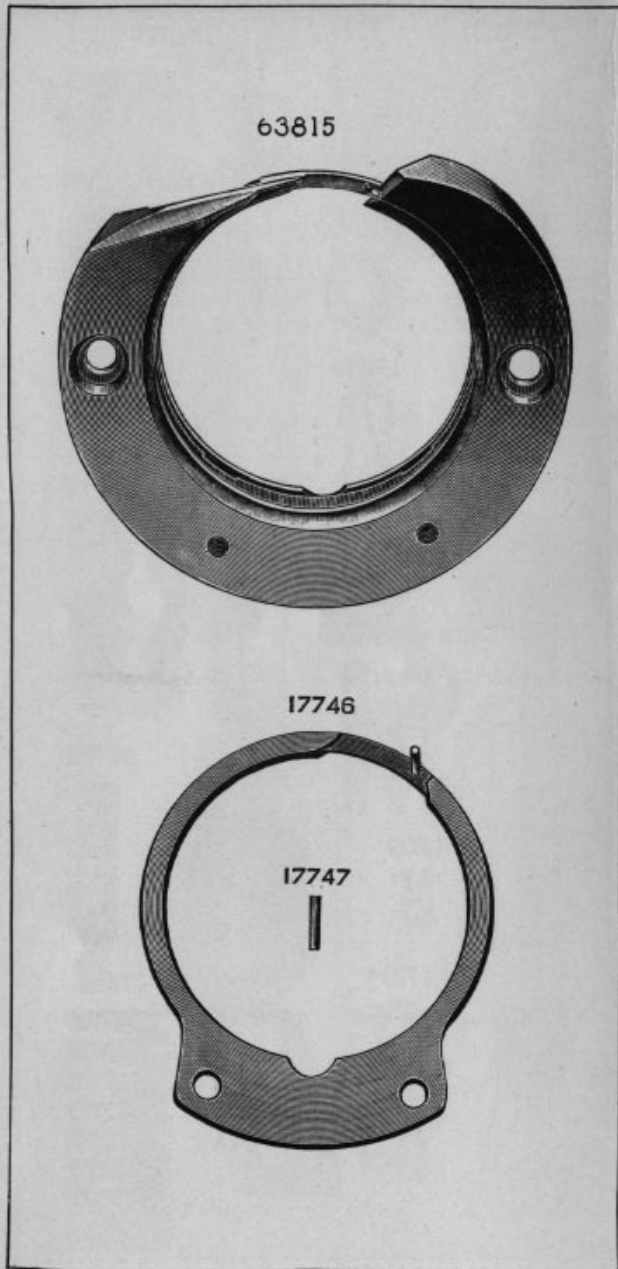

PLATE 3721—FULL SIZE

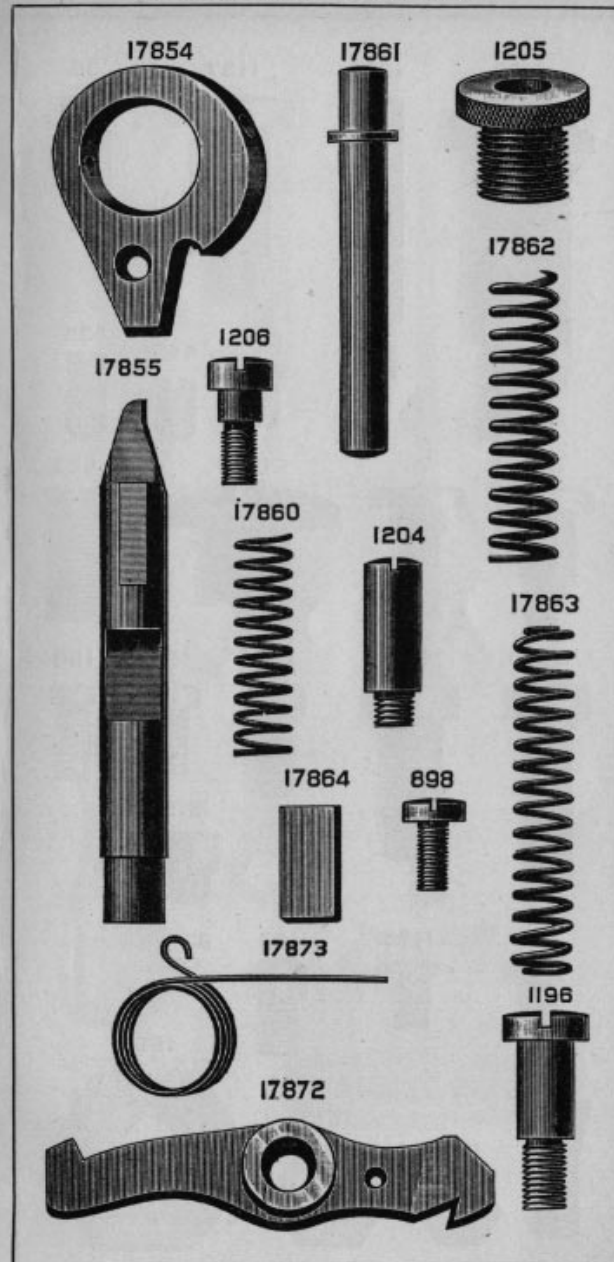

PLATE 3724—FULL SIZE

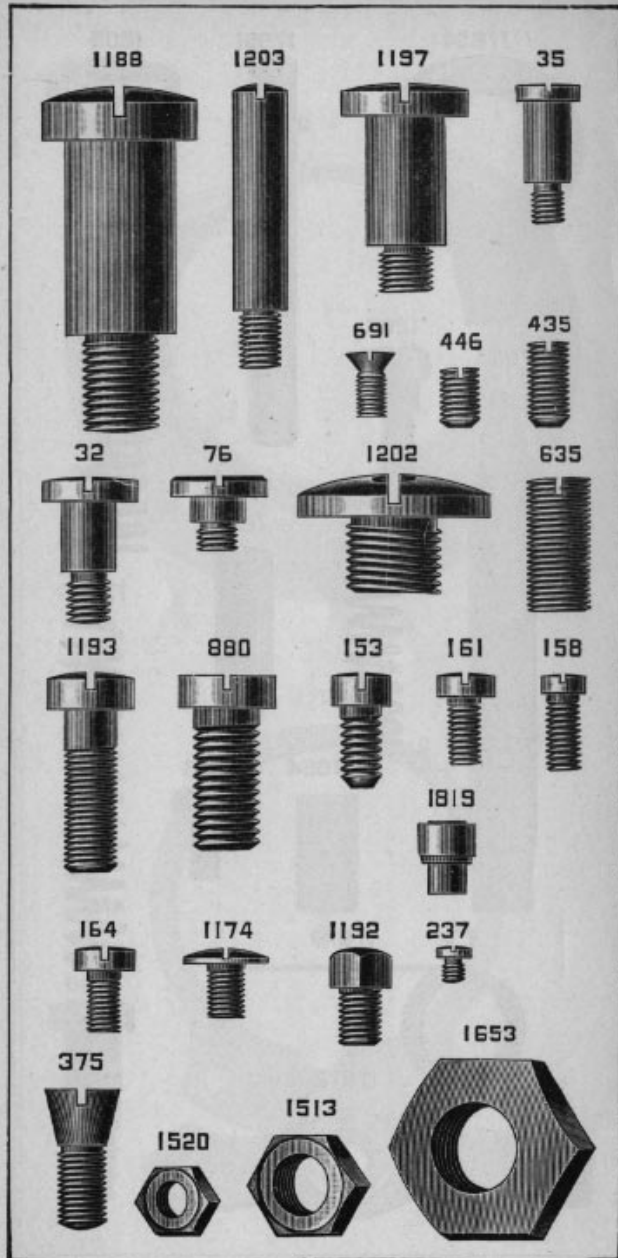

PLATE 3727—ONE-HALF SIZE

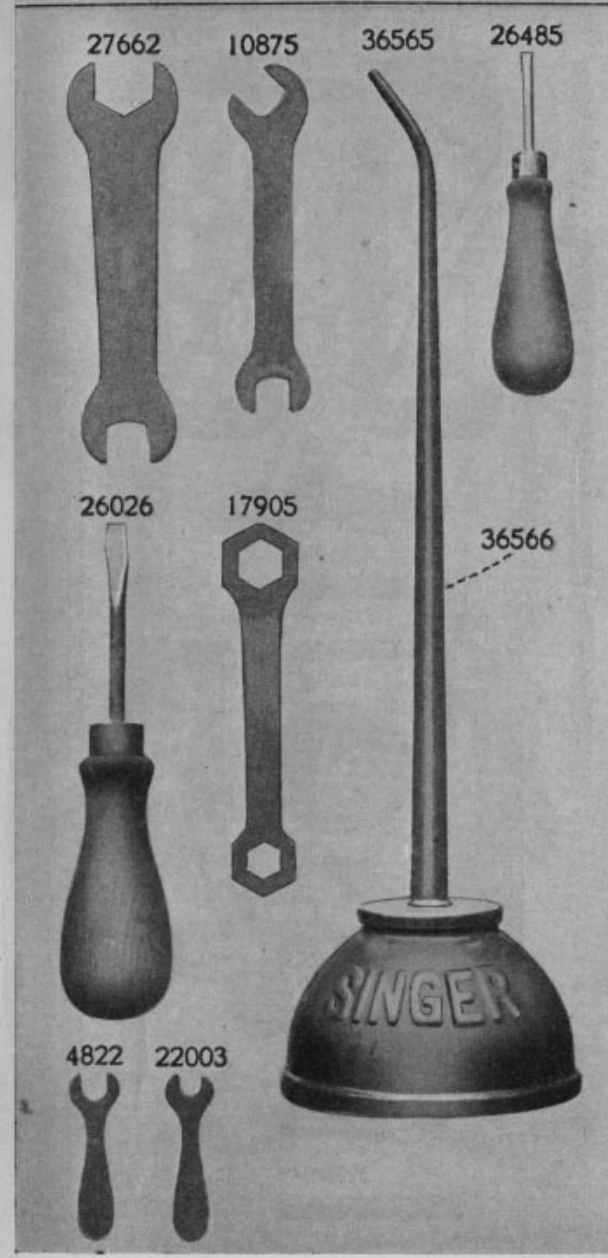

PLATE 3728—ONE-FOURTH SIZE

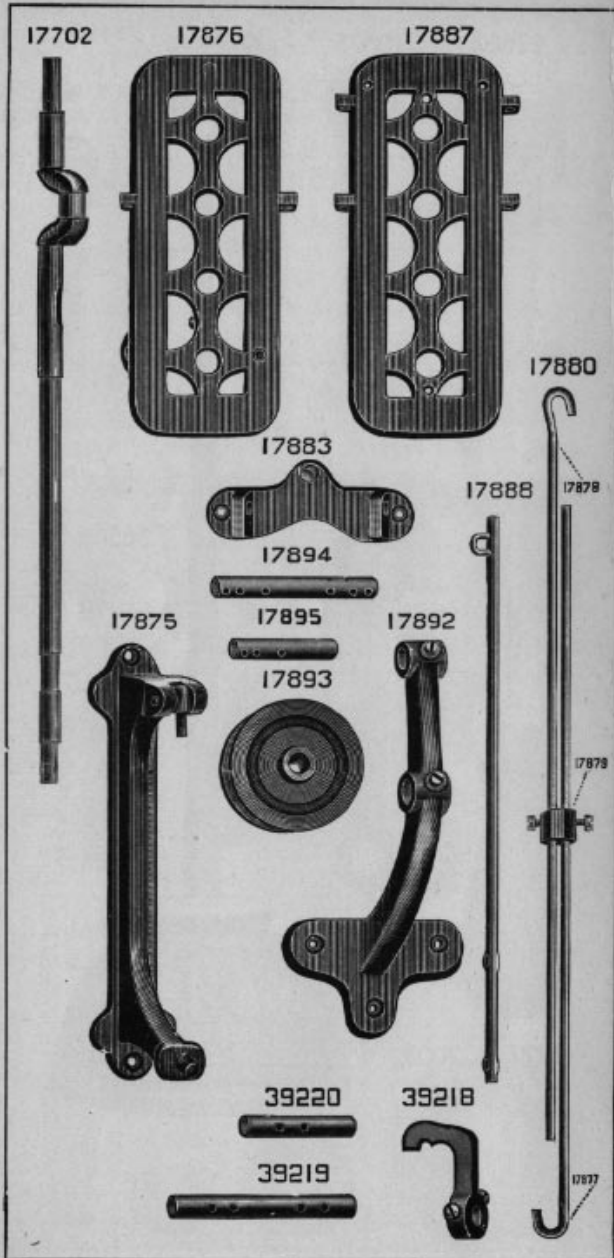

PLATE 3749—ONE-FOURTH SIZE

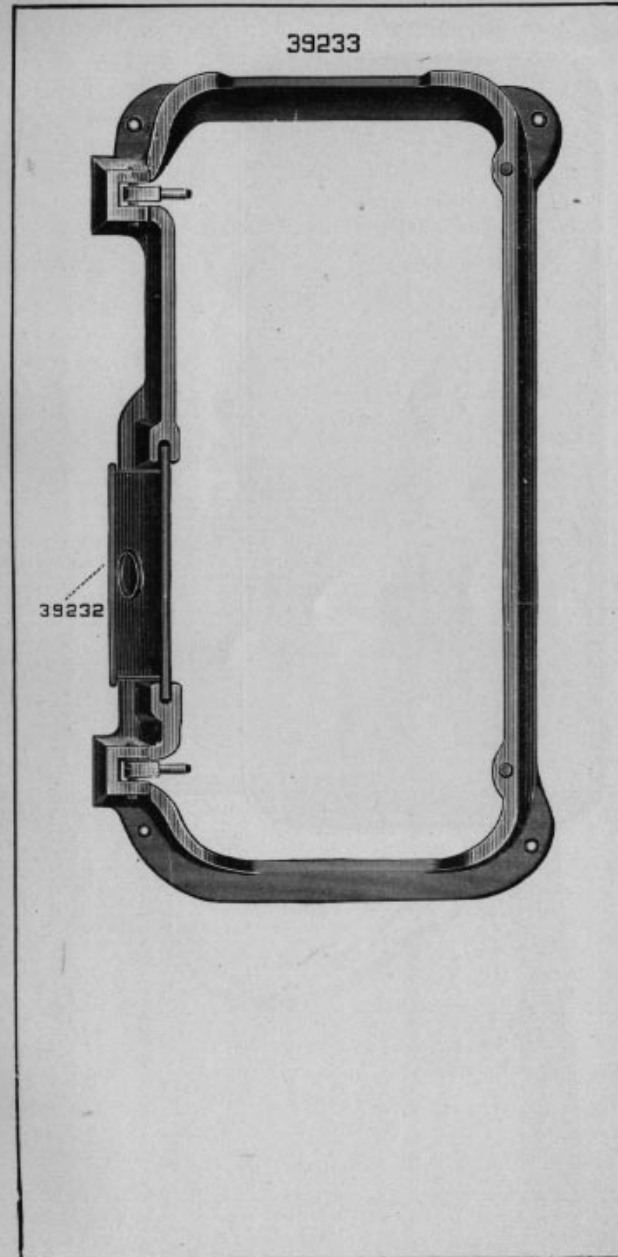

PLATE 3750—ONE-FOURTH SIZE

39234

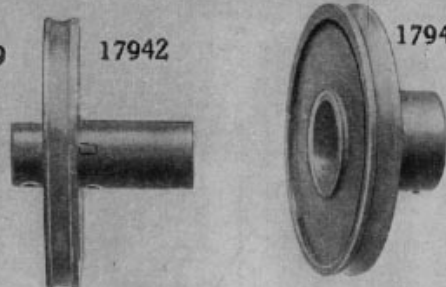

PLATE 3774—ONE-HALF SIZE

39299

17942

17941



39332

39290

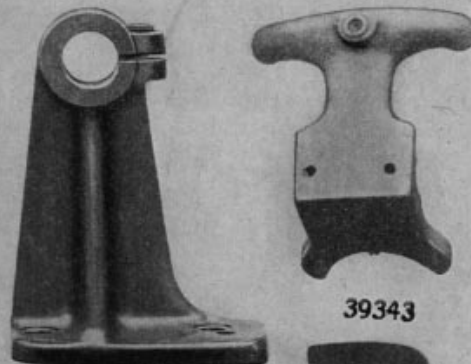

39343

39222

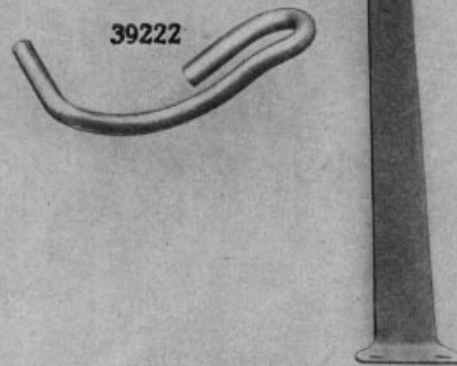

PLATE 3776—FULL SIZE

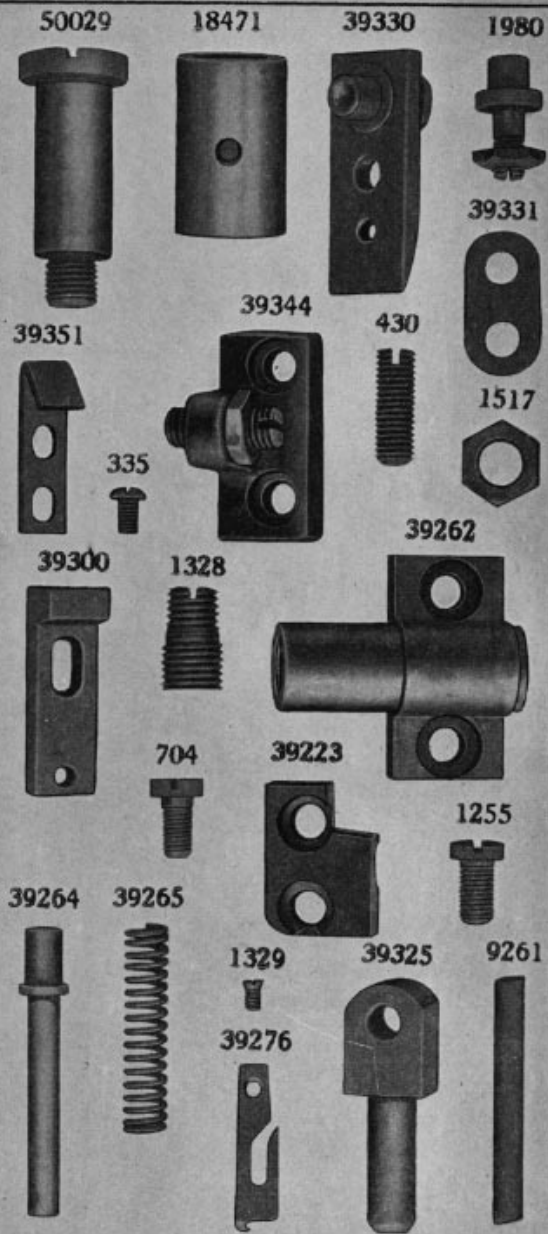

PLATE 3777—FULL SIZE

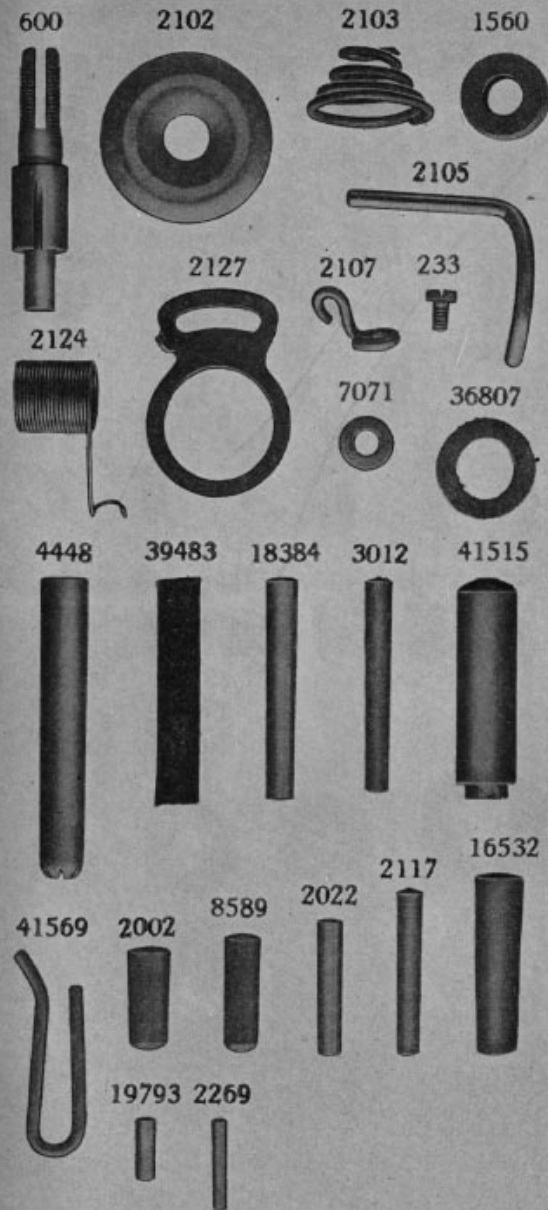

PLATE 3778—FULL SIZE

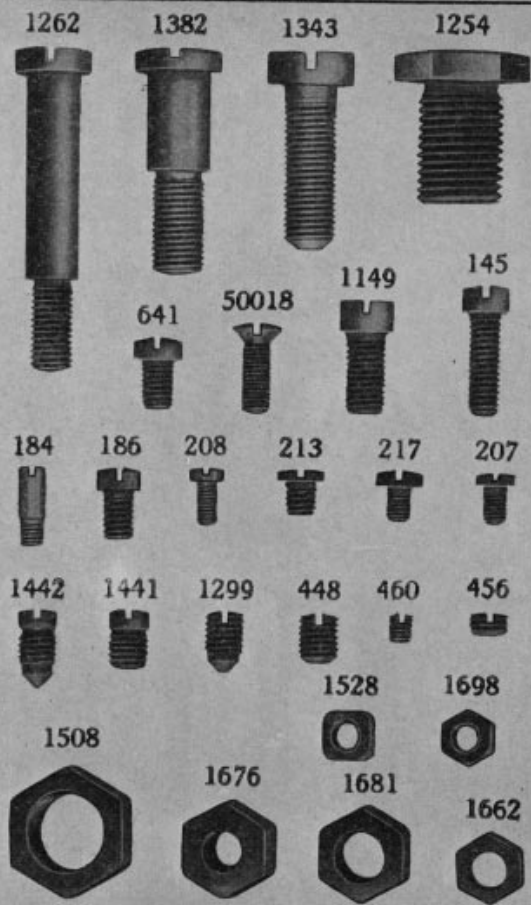

PLATE 3780—ONE-HALF SIZE

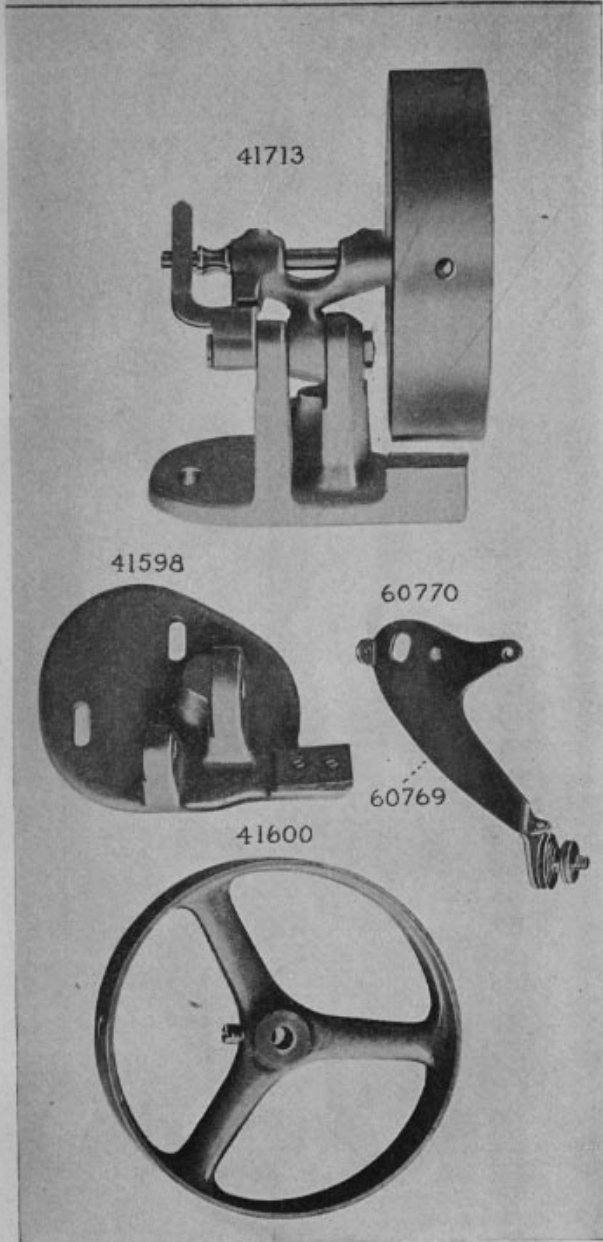

PLATE 3781—FULL SIZE

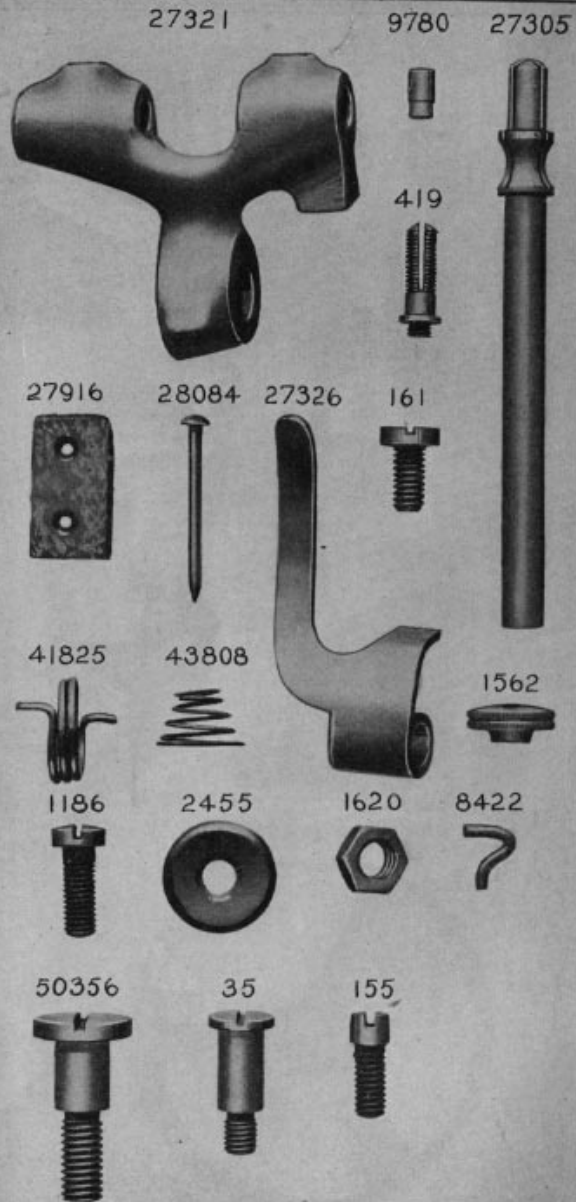

PLATE 3790—ONE-HALF SIZE

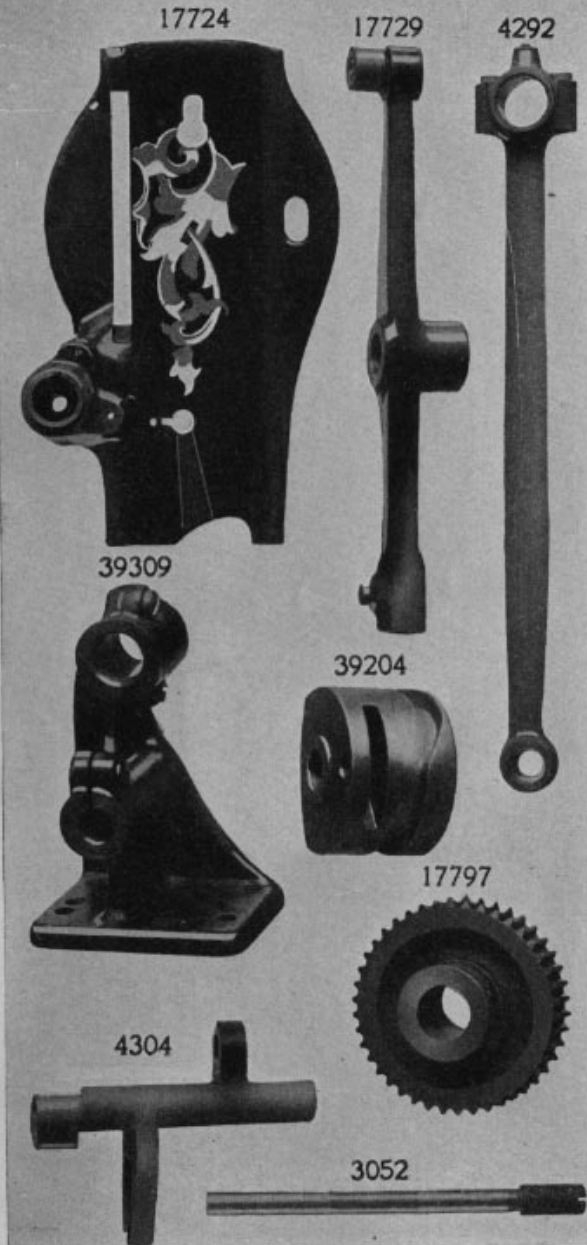

PLATE 3791—ONE-HALF SIZE

39430

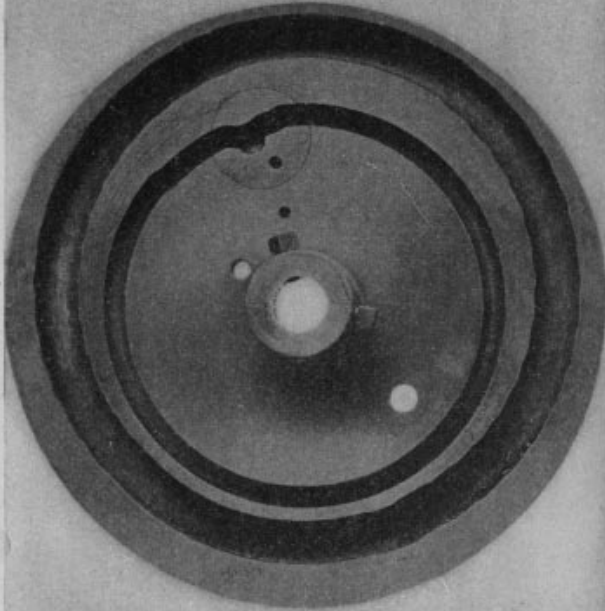

PLATE 3794—FULL SIZE

17808



17807



17811

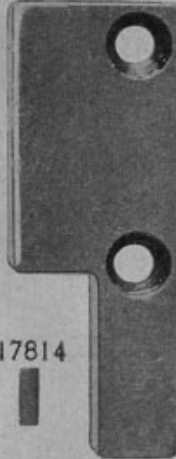

17915



1191



690



17914



17810

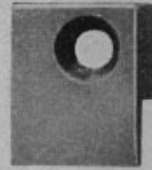

17814



39313



17916



39297

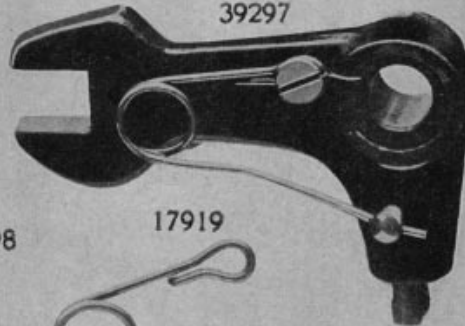

1420



39298



17919



PLATE 3795—FULL SIZE



PLATE 3842—FULL SIZE

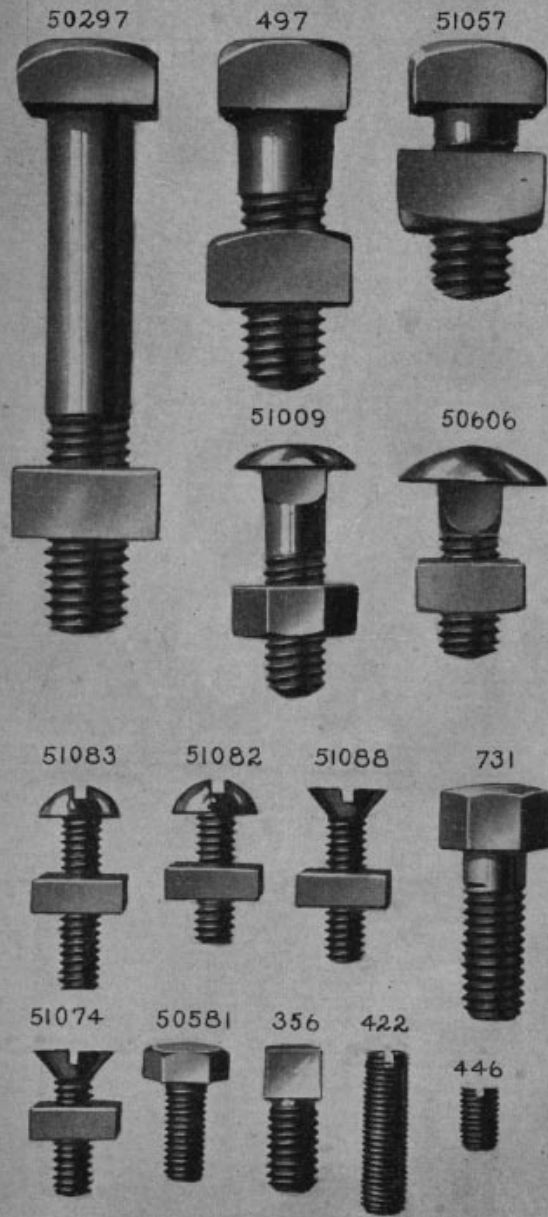

PLATE 3845—FULL SIZE

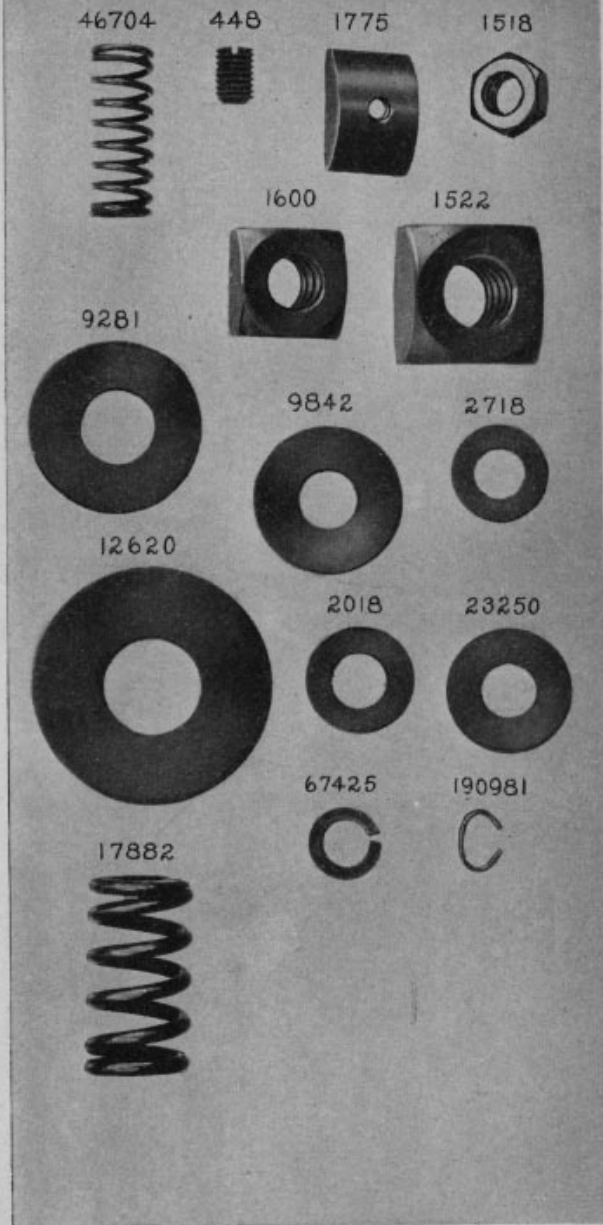

PLATE 4079—ONE-HALF SIZE

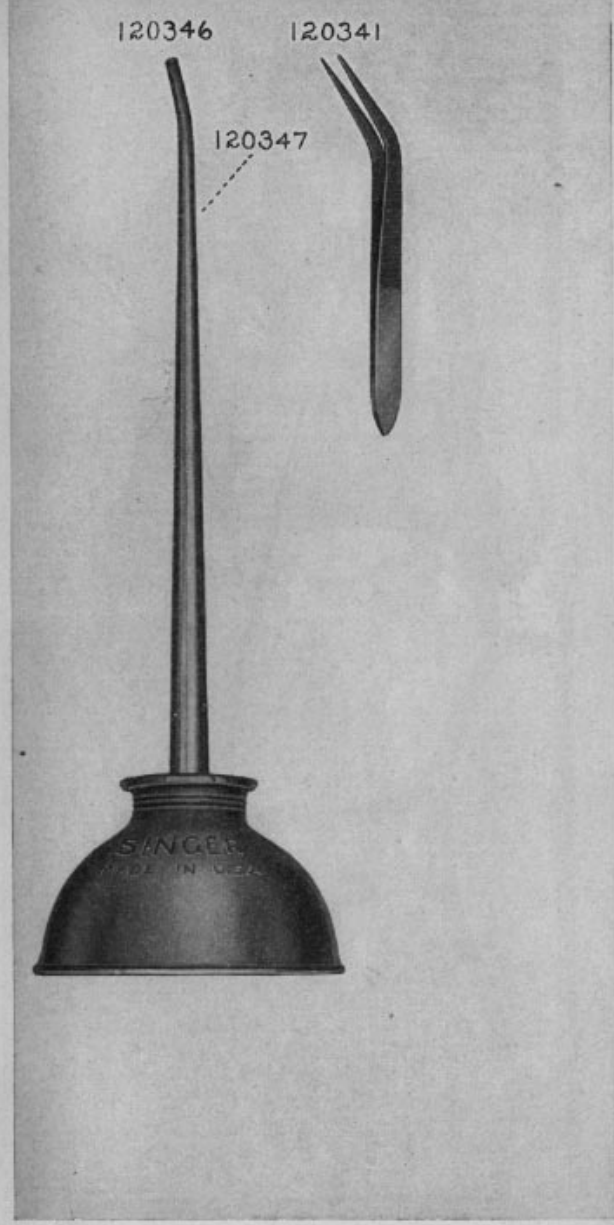

PLATE 5918—ONE-HALF SIZE

60583

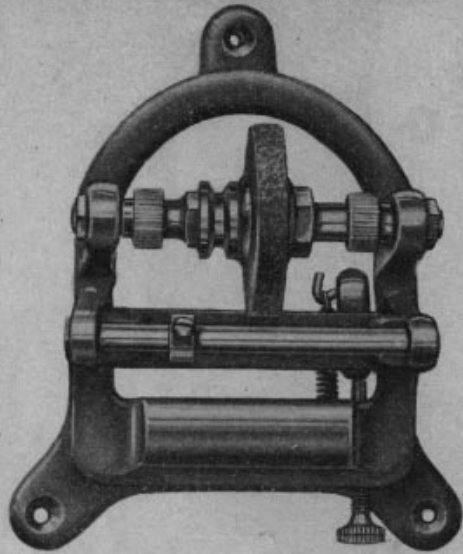

PLATE 7219—ONE-EIGHTH SIZE

82973

46617

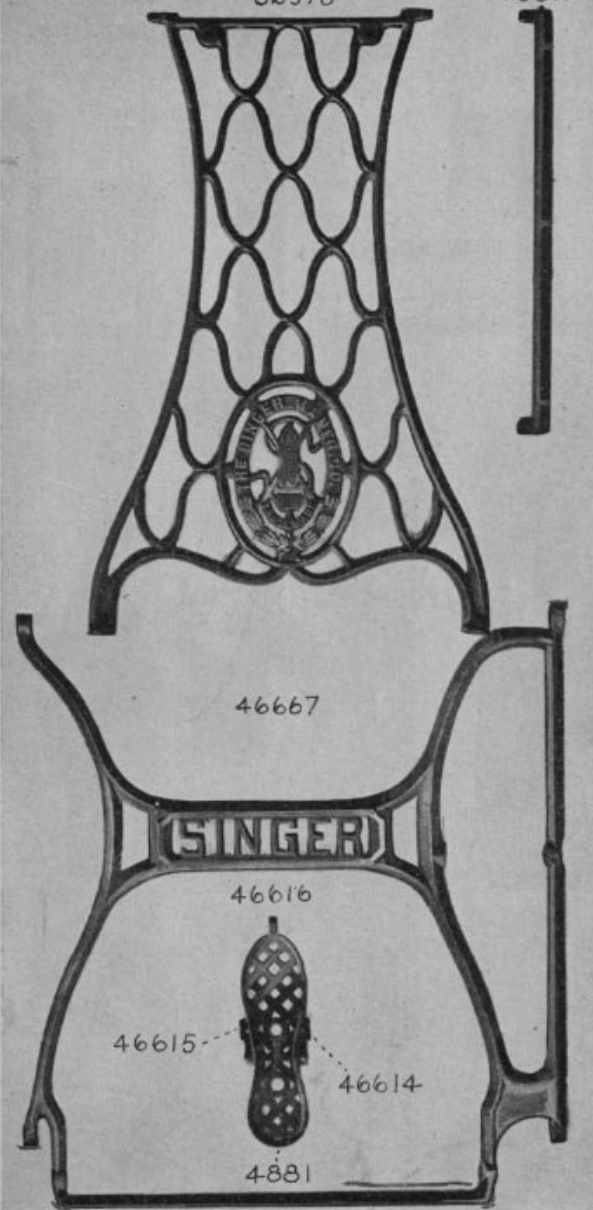
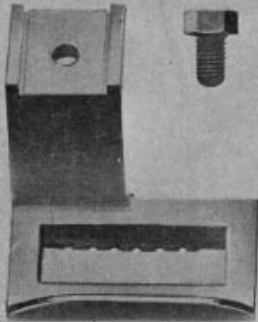

PLATE 7220—FULL SIZE

63855



1209



190



63857

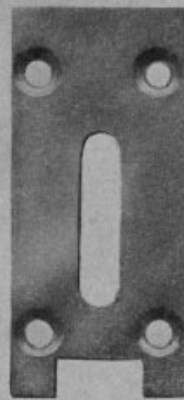

39303

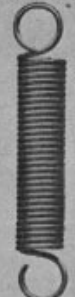

63856



49109



17959



14079



181



17958



17739



1187



50008

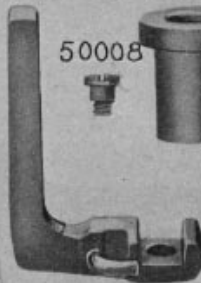

39429



17741



717



1189



17738



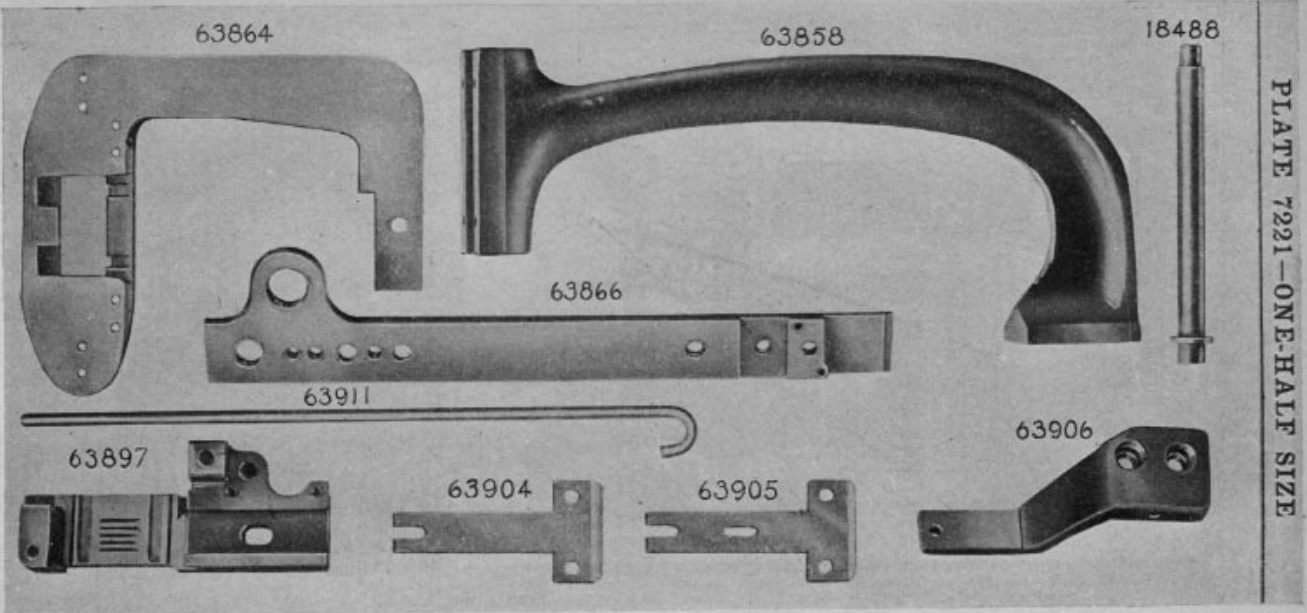

PLATE 7221—ONE-HALF SIZE

PLATE 7222—ONE-HALF SIZE

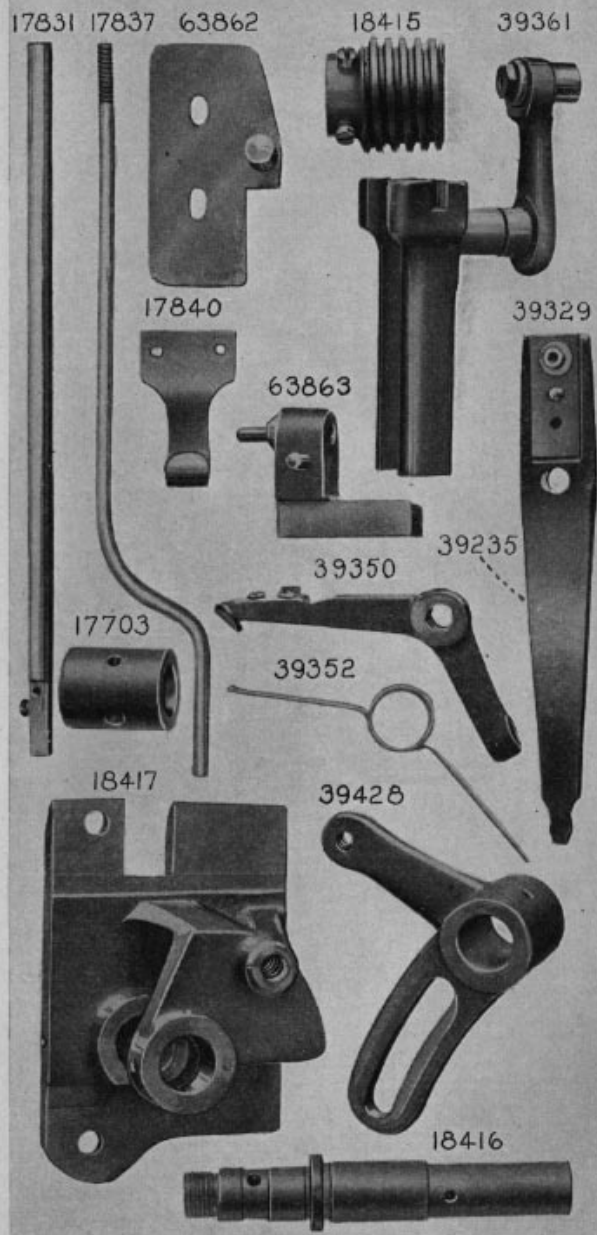

PLATE 7223—ONE-FOURTH SIZE

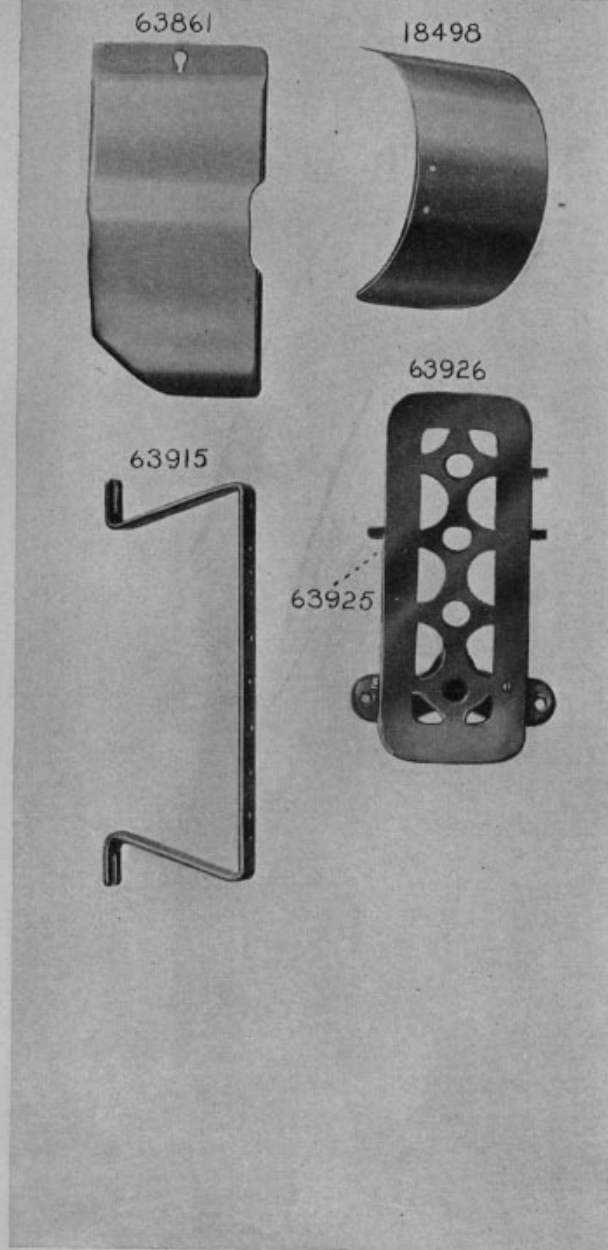

PLATE 7224—FULL SIZE

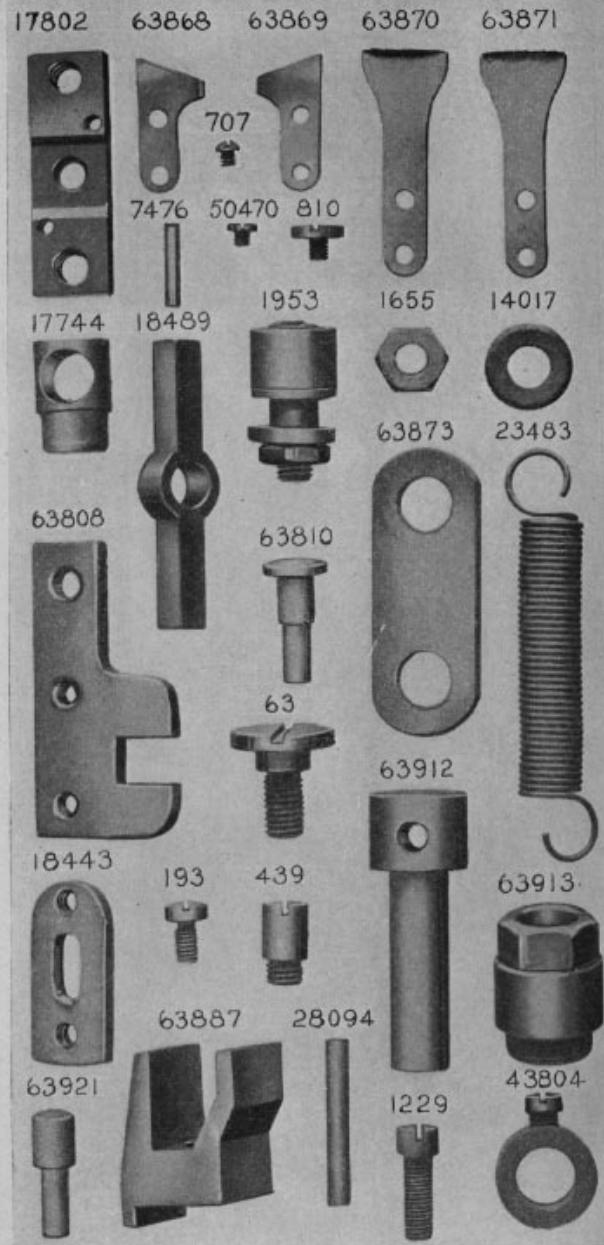

PLATE 7225—ONE-HALF SIZE

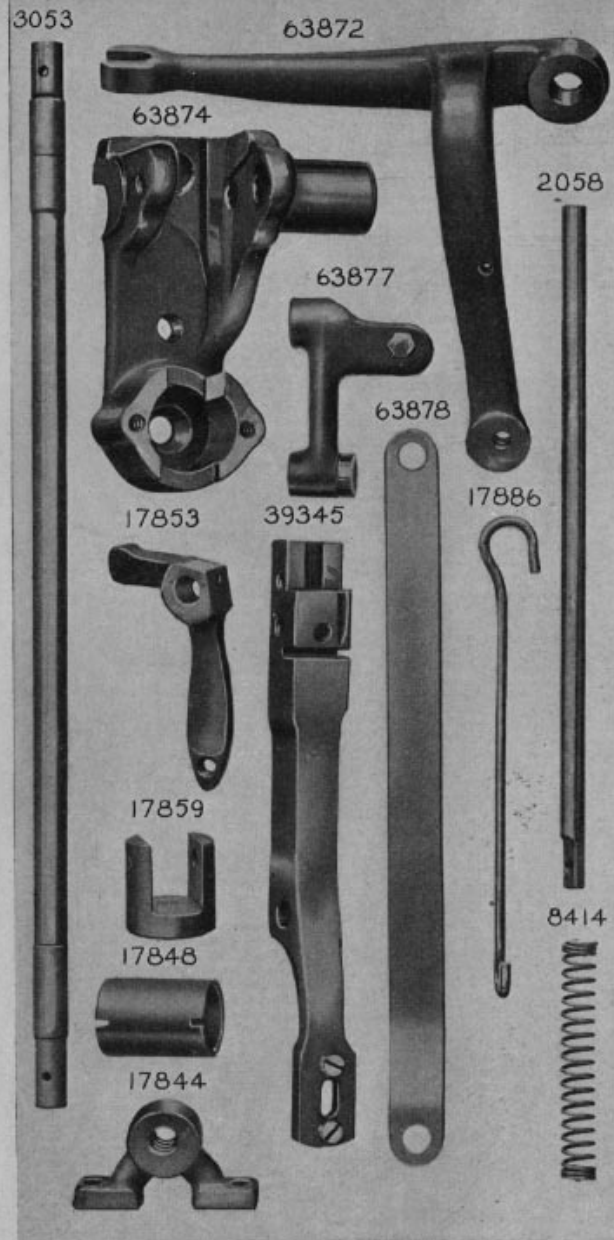

PLATE 7226—ONE-HALF SIZE

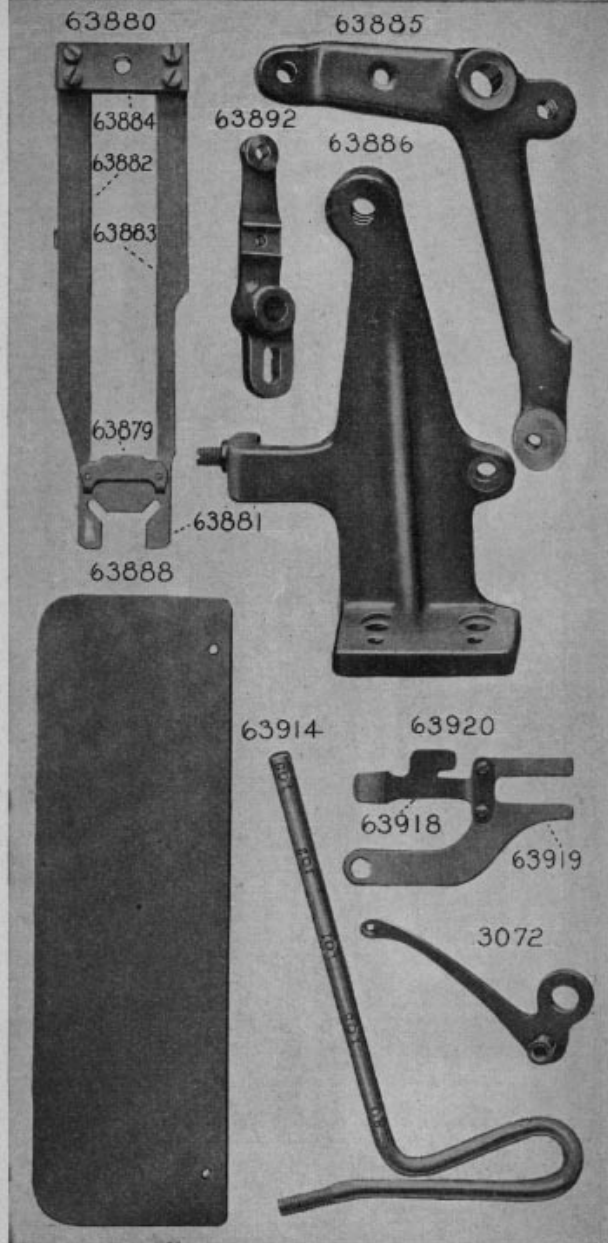

PLATE 7227—FULL SIZE

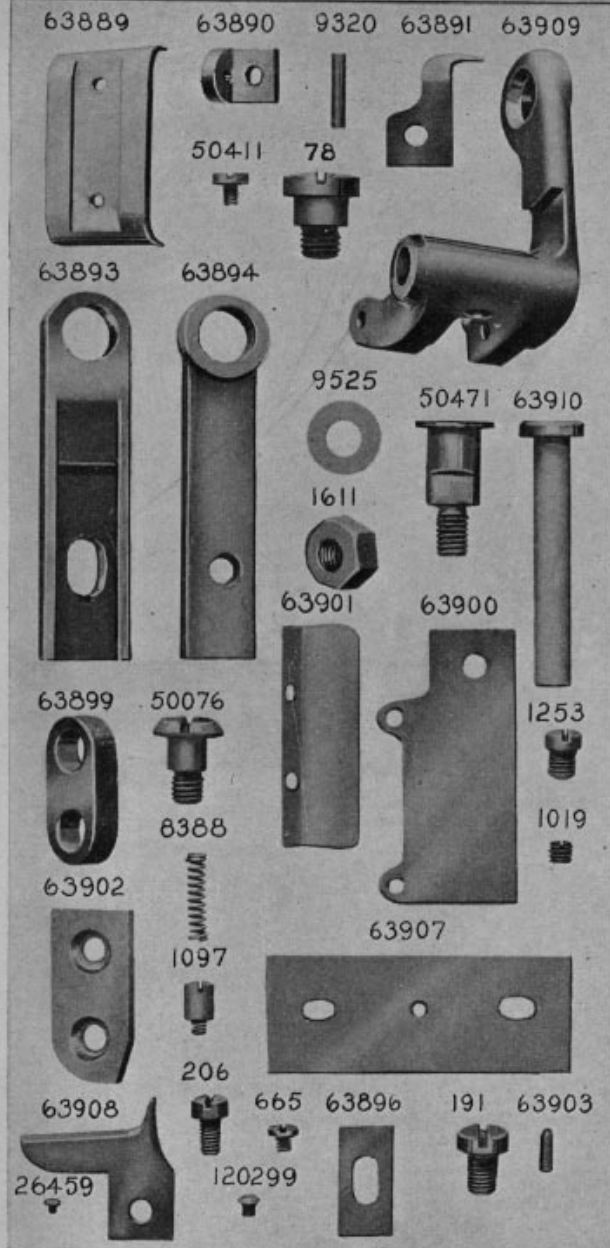
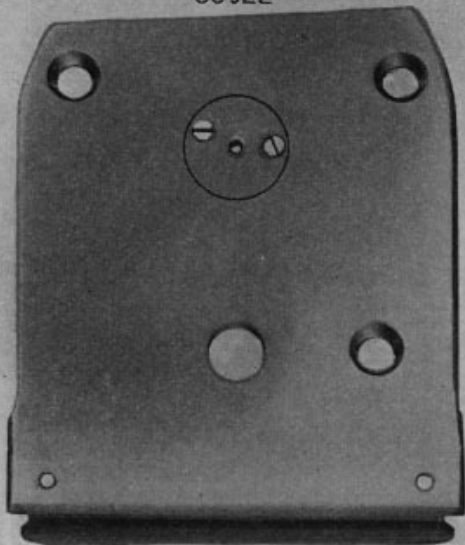
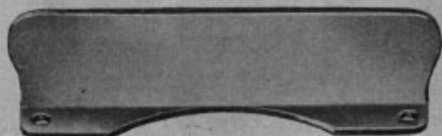

PLATE 7228—FULL SIZE

63922



17749



63923



50406



1208



PLATE 7229—FULL SIZE

17865



1207



17868



17866



17867



17869



25127



56865



26070



26073



13211



17874



201696



201018



200383



60914



225393



PLATE 7230—FULL SIZE

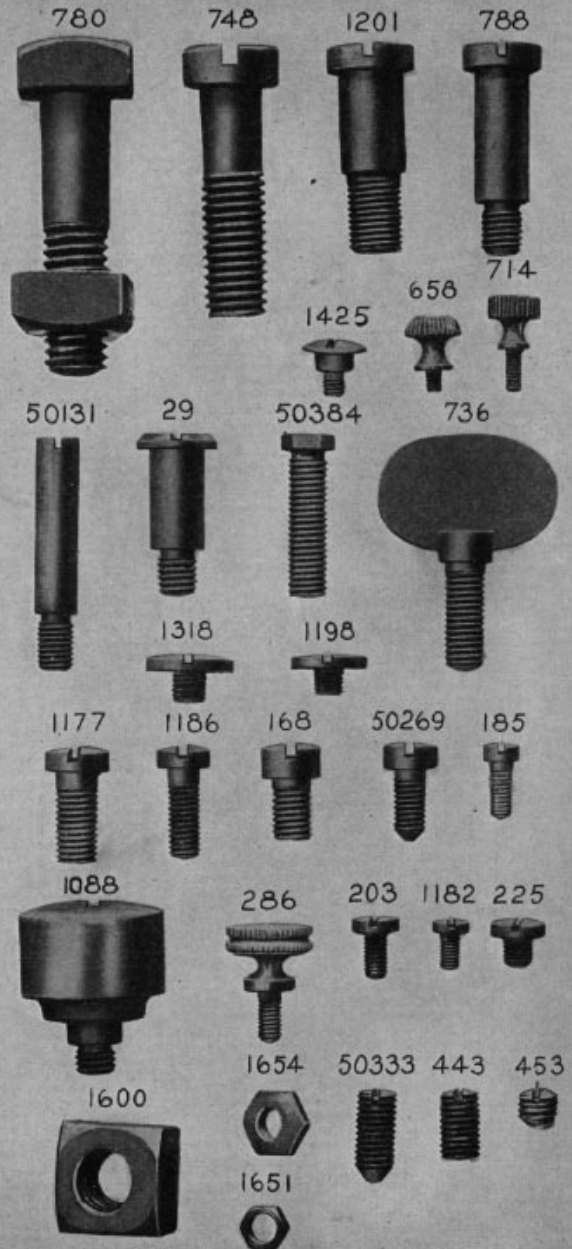

PLATE 7231—ONE-HALF SIZE



PLATE 7232—ONE-HALF SIZE

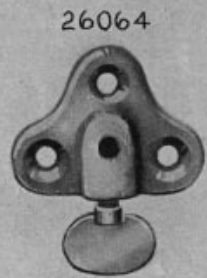
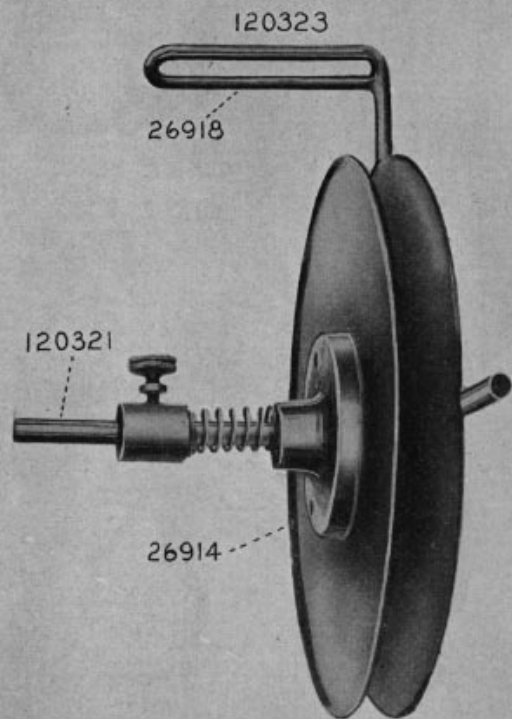

PLATE 7233—ONE-SIXTH SIZE

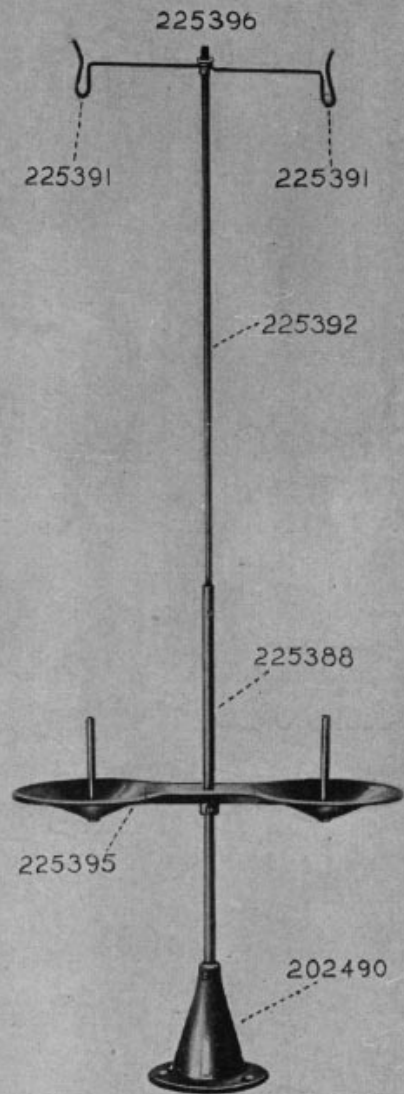
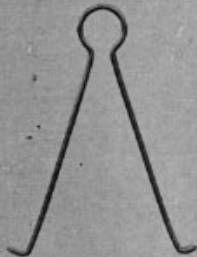

PLATE 7234—ONE-HALF SIZE

27739



225390



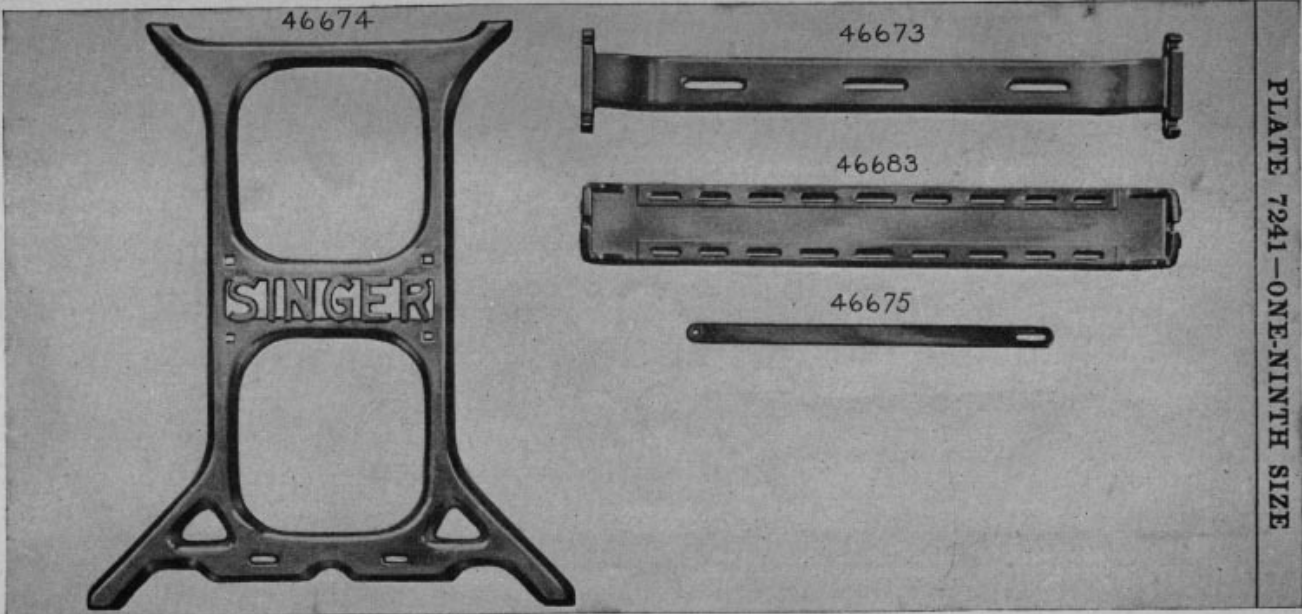

PLATE 7241—ONE-NINTH SIZE

PLATE 7242—ONE-HALF SIZE

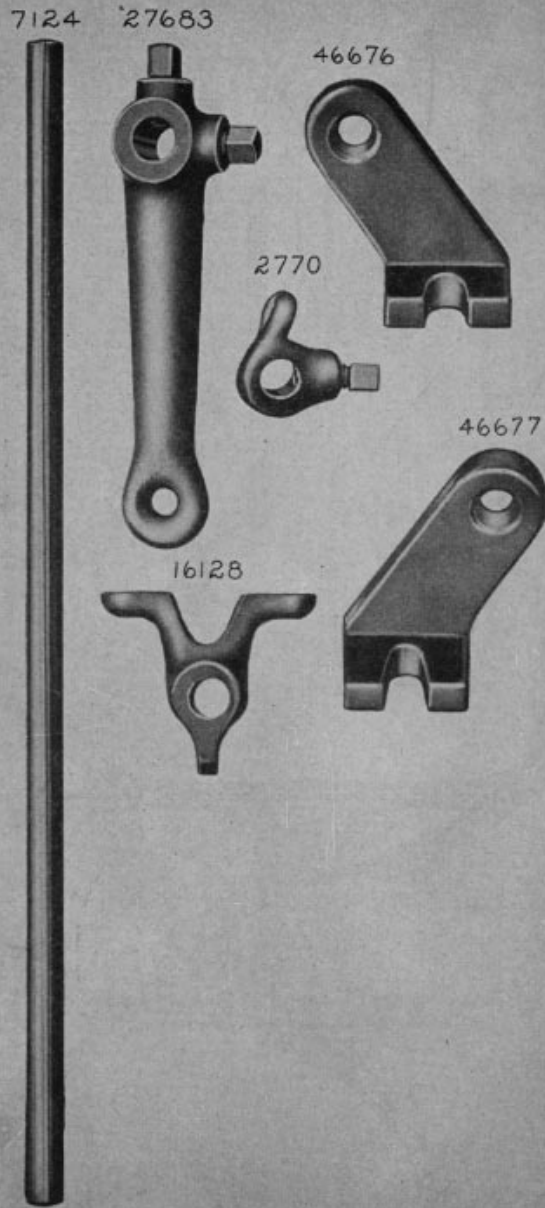

PLATE 7244—FULL SIZE

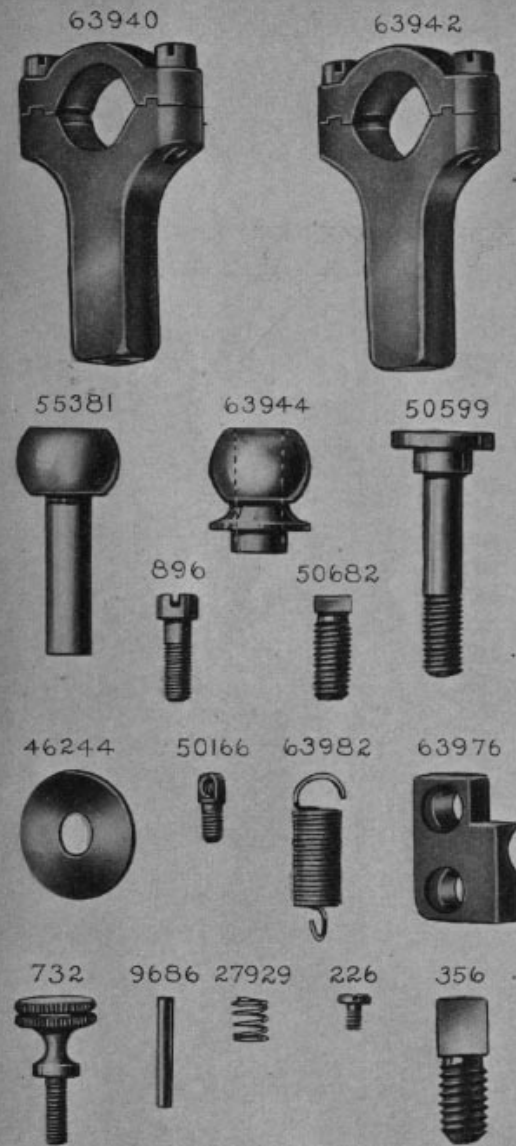

PLATE 7245—FULL SIZE

124674



32675



126509

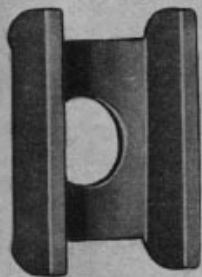

126241

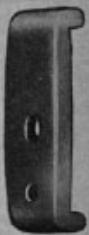

126242

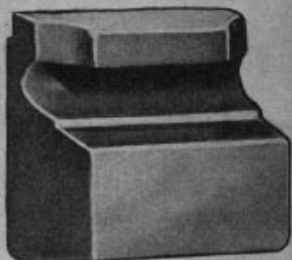

51581



51571



PLATE 7246—ONE-HALF SIZE

63977



62155



63973



63974



46713

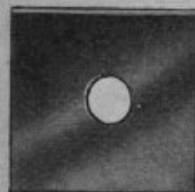

63975

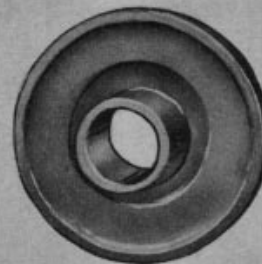

46707



126530



126532

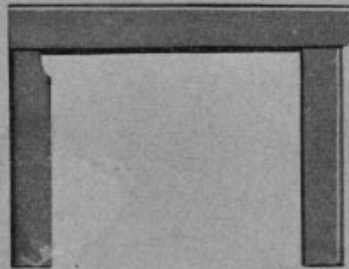

126508

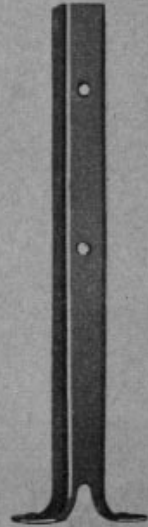

46711

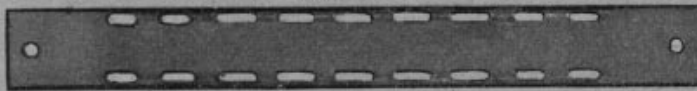

PLATE 9090-ONE-EIGHTH SIZE