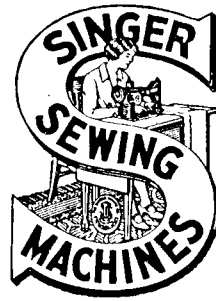


Form 186
November, 1932
PRINTED IN U. S. A.

**HISTORICAL COPY
DO NOT REMOVE**

LIST OF PARTS



HIGH SPEED

MACHINES

Nos. 81-50 and 81-52

THE SINGER MANUFACTURING COMPANY

COPYRIGHT, U. S. A., 1922 and 1932
BY THE SINGER MANUFACTURING CO.
ALL RIGHTS RESERVED FOR ALL COUNTRIES

INDEX

	PAGE
ACCESSORIES	29
BENCH STAND.....	30
FITTINGS FOR 81-50 MACHINE.....	16
“ “ 81-52 MACHINE.....	27
FOOT LIFTER PARTS.....	30
KNIFE GRINDER.....	31
KNEE LIFTER PARTS.....	31
MACHINE NO. 81-50.....	7
“ “ 81-52.....	19
MACHINE BASE.....	32
NUMERICAL LIST OF PARTS.....	35
THREAD UNWINDER.....	33

INSTRUCTIONS FOR ORDERING

In ordering from this list, use **ONLY** the part NUMBER in the **FIRST** column.

The number stamped on a Sewing Machine Part is in every case the number of the single part only.

Every combination of parts sent out as such has its specific number, which, although not stamped on the parts, must be used when ordering the combination.

Each number always indicates the **SAME PART** in whatever list it appears, or for whatever machine.

The letters after some of the numbers indicate the style of finish only, as follows:

- A—Hardened, Polished, Nickel Plated and Buffed
- B—Polished, Nickel Plated and Buffed
- C—Hardened Only
- D—Polished Only
- E—Soft, Not Polished
- F—Hardened and Polished
- H—Blued
- J—Nickel Plated Only
- K—Hardened and Nickel Plated
- L—Brass Plated
- M—Oxidized
- N—Japanned, Dull
- P—Japanned, Bright
- R—Merlized
- T—Copper Plated
- T. A.—Hardened, Polished, Copper and Nickel Plated and Buffed
- T. B.—Copper and Nickel Plated and Polished
- T. J.—Copper and Nickel Plated Only
- T. K.—Hardened, Copper and Nickel Plated
- T. M.—Copper Plated and Oxidized
- T. L.—Copper and Brass Plated
- U—Zinc Plated
- V—Silver Plated
- W—Polished and Nickel Plated
- Y—Black Nickel Plated Only
- Z—Chromium Plated
- Z. B.—Polished, Nickel Plated, Buffed and Chromium Plated
- Z. J.—Nickel and Chromium Plated

These letters **MUST BE USED** when they appear in the list; and **AFTER** the number **as** in the list.

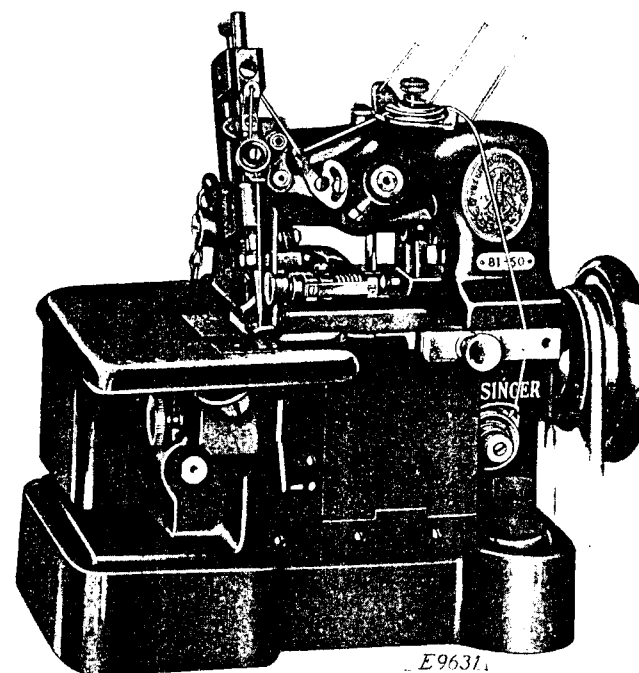
In this series:

- 1 to 1500 and 50001 to 51500 are Screw Numbers
- 1501 to 1800 and 51501 to 51800 are Nut Numbers
- 1801 to 2000 and 51801 to 52000 are Roller Numbers
- 2001 to 50000 and 52001 and upward are numbers of Machine Parts

The figures in the second column refer only to the plates, illustrating the parts, and are **NOT TO BE USED** in ordering.

Parts marked with an asterisk (*) are furnished only when repairs are made at factory.

LIST OF PARTS COMPLETE FOR



MACHINE No. 81-50

FOR TRIMMING, OVEREDGING AND CLOSING SEAMS IN LIGHT AND MEDIUM WEIGHT KNIT GOODS AND RAYON. BIGHT ADJUSTABLE FROM $\frac{1}{16}$ TO $\frac{5}{32}$ INCH. THREE-THREAD STITCH. FOOT LIFTER. HAS AN IMPROVED OILING SYSTEM, WHICH AUTOMATICALLY OILS ALL OF THE PRINCIPAL BEARINGS OF THE MACHINE. BALANCE WHEEL No. 132632. DIAMETER OF BELT GROOVE $1\frac{7}{8}$ INCHES. SPEED 5000.

NOTE: This machine is regularly fitted for Rayon.

NO.	PLATE	NAME
*132522	---	Arm with 42253, 132580 and two each 462c, 624c and 132589.....
4389	7416	Arm Dowel Pin.....
68350	7416	" Oil Cup.....
949E	7417	" Screw.....

NO.	PLATE	NAME
132632	20776	Balance Wheel, 1 $\frac{1}{8}$ in. pulley, with 446c and 1285c.....
1285c	7418	Balance Wheel Position Screw.....
446c	7409	" " Set Screw.....
132524	20777	Cloth Plate with 132525.....
132601	20777	" " Extension (lower).....
233E	7416	" " " " Screw.....
42108	7416	" " " (upper).....
233E	7416	" " " " Screw.....
*132525	—	" " Hinge Bracket.....
132526	7416	" " " Stud.....
50150c	7416	" " " " Set Screw.....
42005	7416	" " Lock Spring.....
236c	7416	" " " " Screw.....
132527	—	Cloth Plate complete, Nos. 42005, 42108, 132524, 132601, two 236c and five 233E.....
42147	7406	Feed (back) Bar.....
61c	7406	" " " Hinge Screw.....
42148	7406	" " Connecting Link.....
1132c	7406	" " " " H i n g e Screw.....
42150	7406	Feed (back) Regulator.....
1132c	7406	" " " " Hinge Screw.....
190J	7406	" " " " Set Screw.....
1444c	7406	" " " " Thumb Screw.....
42151	7406	" (front) Bar with 1253c.....
132528	7406	" " " " Hinge Pin.....
1253c	7406	" " " " " Set Screw.....
132529	7407	" " Connecting Rod with 171c, 1695J, 132530 and two 1057E.....
132619	—	Feed (front) Connecting Rod 132529 with 132534.....
*132530	—	Feed (front) Connecting Rod Cap.....
1057E	7407	" " " " " Screw.....
51292c	7407	" " " " " H i n g e Screw.....
171c	7407	Feed (front) Connecting Rod Hinge Screw Clamping Screw.....
1695J	7407	Feed (front) Connecting Rod Hinge Screw Clamping Screw Nut.....
1520J	7407	Feed (front) Connecting Rod Hinge Screw Nut.....
*132531	—	Feed (front) Eccentric.....
*132532	—	" " " " Body.....
1036c	7407	" " " " " Set Screw.....
19047	7407	" " " " Clamping Washer.....

NO	PLATE	NAME
201J	7407	Feed (front) Eccentric Clamping Washer Screw.....
132533	7407	Feed (front) Eccentric Oil Tube.....
132534	7407	Feed (front) Eccentric complete, Nos. 201J, 19047, 51145c, 132531 to 132533, 132628 and two 1036c.....
132651	7407	Feed (front) Eccentric Cover.....
50253J	7407	" " " " " Screw.....
132536	7408	" " " " Lubricator with 132537.....
132537	7408	Feed (front) Eccentric Lubricator Oil Wick (braided cotton).....
132649	7408	Feed (front) Lifting Eccentric with two 462c.....
132539	7408	Feed (front) Lifting Eccentric Connection.....
462c	7408	Feed (front) Lifting Eccentric Set Screw.....
51145c	7407	" " Regulating Screw.....
132628	7407	" " " " Washer.....
132540	7406	" " " " Rock Shaft.....
132541	—	Feed (front) Rock Shaft complete, Nos. 1444c, 42021 and 132540.....
42021	7408	Feed (front) Rock Shaft Crank with 157E.....
157E	7408	Feed (front) Rock Shaft Crank Clamping Screw.....
132542	7408	Feed (front) Rock Shaft Hinge Pin with 132544.....
132543	7408	Feed (front) Rock Shaft Hinge Pin Bushing.....
132544	7408	Feed (front) Rock Shaft Hinge Pin Bushing Oil Wick (braided cotton).....
1036c	7407	Feed (front) Rock Shaft Hinge Pin Bushing Set Screw.....
132544	7408	Feed (front) Rock Shaft Hinge Pin Oil Wick (braided cotton).....
132607	7420	Feed Dog, 34 teeth (22 teeth to the inch) for seaming rayon.....
190J	7406	Feed Dog Screw.....
*132545	—	Frame.....
132546	20777	" Bottom Cover with 132594.....
132547	20777	" " " " Gasket.....
190E	7406	" " " " Screw.....
132548	7416	" Oil Cup.....
132549	20776	" Rotary Shaft with 132558 and 132559.....

NO.	PLATE	NAME
42049	7410	Knife (stationary) Stud.....
42050	7411	Looper (left hand).....
132566	7411	“ “ “ Lever with 50117c and two 1253c.....
132567	7411	Looper (left hand) Lever Connecting Stud.....
132645	7411	Looper (left hand) Lever Connecting Stud Hinge Pin.....
1253c	7411	Looper (left hand) Lever Connecting Stud Hinge Pin Set Screw.....
132569	7411	Looper (left hand) Lever Hinge Stud with 132552.....
132552	7411	Looper (left hand) Lever Hinge Stud Oil Pad (braided cotton).....
132571	7411	Looper (left hand) Lever Hinge Stud Oil Wick (braided cotton).....
1036c	7408	Looper (left hand) Lever Hinge Stud Set Screw.....
50117c	7411	Looper (left hand) Set Screw.....
132630	7411	“ (right hand).....
132572	7411	“ “ “ and Spreader Lever with 50200c.....
132573	7412	Looper (right hand) and Spreader Lever Ball Stud.....
50200c	7413	Looper (right hand) and Spreader Lever Ball Stud Set Screw.....
132574	7412	Looper (right hand) and Spreader Lever Connection with 132575, 132576 and four 1057E.....
132617	—	Looper (right hand) and Spreader Lever Connection 132574 with 132553 and 132573.....
*132575	—	Looper (right hand) and Spreader Lever Connection Cap (lower).....
1057E	7412	Looper (right hand) and Spreader Lever Connection Cap (lower) Screw.....
*132576	—	Looper (right hand) and Spreader Lever Connection Cap (upper).....
1057E	7412	Looper (right hand) and Spreader Lever Connection Cap (upper) Screw.....
132577	7412	Looper (right hand) and Spreader Lever Connection Guide.....
196F	7412	Looper (right hand) and Spreader Lever Connection Guide Screw.....
132578	7412	Looper (right hand) and Spreader Lever Hinge Pin with 132579.....

NO.	PLATE	NAME
132543	7408	Looper (right hand) and Spreader Lever Hinge Pin Bushing.....
132579	7412	Looper (right hand) and Spreader Lever Hinge Pin Bushing Oil Wick (braided cotton).....
1036c	7408	Looper (right hand) and Spreader Lever Hinge Pin Bushing Set Screw.....
132579	7412	Looper (right hand) and Spreader Lever Hinge Pin Oil Pad (braided cotton).....
1036c	7408	Looper (right hand) and Spreader Lever Hinge Pin Set Screw.....
197J	7411	Looper (right hand) Screw.....
42054	7412	Needle Bar.....
42253	7412	“ “ Bushing (lower).....
132580	7412	“ “ “ (upper).....
132581	7412	“ “ “ “ Oil Pad (braided cotton).....
132621	7412	Needle Bar Bushing (upper) Oil Pad Cover.....
217J	7412	Needle Bar Bushing (upper) Oil Pad Cover Screw.....
462c	7408	Needle Bar Bushing Set Screw.....
132598	7412	“ “ Connecting Bracket with 187E and 223F.....
187E	7412	Needle Bar Connecting Bracket Clamp- ing Screw.....
132582	7412	Needle Bar Connecting Link.....
132583	7412	“ “ “ “ Hinge Pin with 132584.....
132584	7412	Needle Bar Connecting Link Hinge Pin Oil Pad (wick).....
223F	7412	Needle Bar Connecting Link Hinge Pin Set Screw for 132598.....
620c	7413	Needle Bar Connecting Link Hinge Pin Set Screw for 132597.....
132585	7413	Needle Bar Connecting Rod with 132586, 132587 and four 1057E.....
*132586	—	Needle Bar Connecting Rod Cap (lower)
1057E	7413	“ “ “ “ “ “ Screw.....
*132587	—	Needle Bar Connecting Rod Cap (upper)
1057E	7413	“ “ “ “ “ “ “ Screw.....
132577	7412	Needle Bar Connecting Rod Guide.....
196F	7412	“ “ “ “ “ “ Screw
132588	7413	“ “ Crank (back) with 132590 and two 1259c.....

NO.	PLATE	NAME
132573	7412	Needle Bar Crank (back) Ball Stud....
1259c	7413	" " " " " " Set Screw.....
132589	7413	Needle Bar Crank (back) Bushing.....
624c	7413	" " " " " " Set Screw.....
132590	7413	Needle Bar Crank (back) Oil Pad (wick)
1259c	7413	" " " " Set Screw....
132597	7413	" " " (front) with 620c, 1259c and 50200c.....
132615	—	Needle Bar Crank (front) 132597 with 132582, 132598 and two 132583.....
1259c	7413	Needle Bar Crank (front) Position Screw
50200c	7413	" " " " Set Screw....
42115	7413	" " Thread Retainer Bracket...
42483	7413	" " " " Disc.....
93c	7413	" " " " Screw.....
10107	7413	" " " " Spring....
1728c	7412	" Clamping Nut.....
42066	7413	" Guard.....
171F	7413	" " Screw.....
132608	7420	Presser Foot Chaining-off Finger.....
233J	7420	" " " " Screw
132609	—	" " " " Plate.....
132610	7420	" " " " Collar with 240c.....
132611	7420	Presser Foot Chaining-off Plate Collar Guide Pin.....
735c	7420	Presser Foot Chaining-off Plate Collar Guide Pin Set Screw.....
240c	7420	Presser Foot Chaining-off Plate Collar Set Screw.....
62527	7420	Presser Foot Hinge Pin.....
132648	—	" " Plate.....
132612	—	" " Shank with 735c.....
14058	7420	" " Spring.....
132613	7420	Presser Foot (spring hinged) complete, for rayon, Nos. 233J, 14058, 62527, 132608 to 132612 and 132648.....
1324c	7420	Presser Foot Screw.....
39541	7420	" " " Washer.....
42069	20776	" Lever.....
42045	7410	" " Hinge Stud.....
1120c	7417	" " " " Set Screw....
42070	7414	" " Lifter.....
85D	7414	" " " Hinge Screw.....
1377c	7418	" " Screw Stud (eccentric)....

NO.	PLATE	NAME
1547J	7409	Presser Lever Screw Stud Nut....
42071	7414	" " Spring.....
1378D	7414	Pressure Regulating Thumb Screw.....
132631	7411	Spreader.....
197J	7411	" Screw.....
2102	7414	Tension (looper, left hand) Disc.....
1560c	7414	" " " " Regulating Thumb Nut.....
50148c	7414	Tension (looper, left hand) Screw Stud
124687	—	" " " " " " " 50148c with 1560c.....
54883	7414	Tension (looper, left hand) Spring....
132599	7414	" " " " Thread Guide
2102	7414	" (looper, right hand) Disc.....
1560c	7414	" " " " Regulating Thumb Nut.....
828c	7414	Tension (looper, right hand) Screw Stud
42418	—	" " " " " " " 828c with 1560c.....
10148	7414	Tension (looper, right hand) Spring....
57076	7414	" " " " Thread Guide.....
2102	7414	Tension (needle thread) Disc.....
1560c	7414	" " " " Regulating Thumb Nut....
916c	7414	Tension (needle thread) Screw Stud....
44209	—	" " " " " " 916c with 1560c.....
10148	7414	Tension (needle thread) Spring..
42082	7414	" " " " Thread Guide
132629	7417	Thread (looper, left hand) Eyelet.....
233J	7416	" " " " " Screw
42122	7417	" " " " N i p p e r Spring (lower).....
42123	7417	Thread (looper, left hand) Nipper Spring (upper).....
176J	7417	Thread (looper, left hand) Nipper Spring Screw.....
42084	7417	Thread (looper, left hand) Tube....
462c	7408	" " " " " SetScrew
42126	7417	" " " " Pull-off.....
132591	7417	" (looper, right hand) Pull-off
42244	7417	" " " " " " Eyelet.....
207J	7417	Thread (looper, right hand) Pull-off Eyelet Screw.....

NO.	PLATE	NAME
42093	7417	Thread (looper, right hand) Staple.....
190J	7406	“ “ “ “ “ Screw
42127	7417	“ “ “ “ Take-up
197J	7414	“ “ “ “ “ Screw.....
132622	7417	Thread (needle) Eyelet.....
223J	7412	“ “ “ “ Screw.....
132623	7417	“ “ “ “ Take-up.....
197J	7414	“ “ “ “ “ Screw.....
132614	7420	Throat Plate for 132607.....
742F	7417	“ “ “ “ “ Screw.....

FITTINGS FOR 81-50 MACHINE

FOR RAYON

FOR THREE-THREAD TIGHT STITCH

NO.	PLATE	NAME
132607	7420	Feed Dog, 34 teeth (22 teeth to the inch)
42050	7411	Looper (left hand).....
132630	7411	“ (right hand).....
132613	7420	Presser Foot (spring hinged) complete, Nos. 233J, 14058, 62527, 132608 to 132612 and 132648.....
132614	7420	Throat Plate for 132607.....

FOR TWO-THREAD STITCH

132607	7420	Feed Dog, 34 teeth (22 teeth to the inch)
42050	7411	Looper (left hand).....
132613	7420	Presser Foot (spring hinged) complete, Nos. 233J, 14058, 62527, 132608 to 132612 and 132648.....
132631	7411	Spreader.....
132614	7420	Throat Plate for 132607.....

FOR LIGHT KNIT MATERIAL, SUCH AS SILK,

BALBRIGGAN UNDERWEAR, ETC.

FOR THREE-THREAD STITCH

NO.	PLATE	NAME
42492	7424	Feed (back) Dog, 4 teeth (22 teeth to the inch).....
42491	7424	Feed (front) Dog, 29 teeth (22 teeth to the inch).....
42050	7411	Looper (left hand).....
132630	7411	“ (right hand).....

NO.	PLATE	NAME
42288	7424	Presser Foot Chaining-off Finger.....
233J	7420	“ “ “ “ “ Screw
42405	—	“ “ “ “ Plate (back).....
9320	7424	“ “ “ “ “ Hinge Pin...
14058	7420	“ “ “ “ “ Spring.....
42160	7424	“ “ “ “ “ “ Adjust- ing Pin.....
464c	7424	Presser Foot Plate (back) Spring Adjust- ing Pin Set Screw.....
42263	—	Presser Foot Plate (front).....
42461	7424	“ “ “ “ “ Hinge Pin...
42264	—	“ “ “ “ “ Shank.....
42420	7424	Presser Foot (spring hinged) complete, Nos. 233J, 464c, 9320, 14058, 42160, 42263, 42264, 42288, 42405 and 42461
42493	7424	Throat Plate for 42491 and 42492.....

FOR TWO-THREAD STITCH

42492	7424	Feed (back) Dog, 4 teeth (22 teeth to the inch).....
42491	7424	Feed (front) Dog, 29 teeth, (22 teeth to the inch).....
42050	7411	Looper (left hand).....
42420	7424	Presser Foot (spring hinged) complete, Nos. 233J, 464c, 9320, 14058, 42160, 42263, 42264, 42288, 42405 and 42461
132631	7411	Spreader.....
42493	7424	Throat Plate for 42491 and 42492.....

FOR MEDIUM KNIT MATERIAL OR LIGHT SWEATER WORK

FOR THREE-THREAD STITCH

NO.	PLATE	NAME
42149	7422	Feed (back) Dog, 3 teeth (16 teeth to the inch).....
42262	7422	Feed (front) Dog, 21 teeth (16 teeth to the inch).....
42050	7411	Looper (left hand).....
132630	7411	“ (right hand).....
42158	7422	Presser Foot Chaining-off Finger.....
233J	7420	“ “ “ “ “ Screw
42159	—	“ “ “ “ “ Plate (back).....
9320	7424	“ “ “ “ “ Hinge Pin...
14058	7420	“ “ “ “ “ Spring.....
42160	7424	“ “ “ “ “ “ Adjust- ing Pin.....

NO.	PLATE	NAME
464c	7424	Presser Foot Plate (back) Spring Adjusting Pin Set Screw.....
42263	—	Presser Foot Plate (front).....
42461	7424	" " " " Hinge Pin...
42264	—	" " Shank.....
42265	7422	Presser Foot (spring hinged) complete, Nos. 233a, 464c, 9320, 11058, 42158 to 42160, 42263, 42264 and 42461....
42163	7422	Throat Plate for 42149 and 42262.....

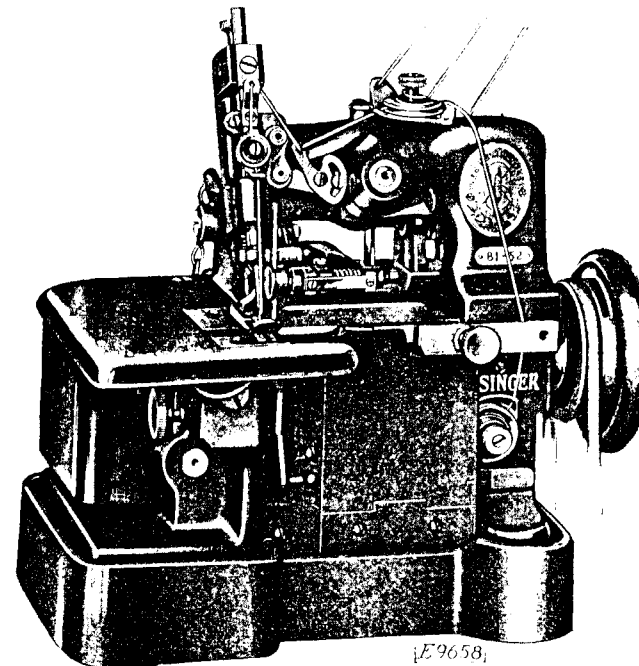
FOR TWO-THREAD STITCH

42149	7422	Feed (back) Dog, 3 teeth (16 teeth to the inch).....
42262	7422	Feed (front) Dog, 21 teeth (16 teeth to the inch).....
42050	7411	Looper (left hand).....
42265	7422	Presser Foot (spring hinged) complete, Nos. 233a, 464c, 9320, 11058, 42158 to 42160, 42263, 42264 and 42461....
132631	7411	Spreader.....
42163	7422	Throat Plate for 42149 and 42262.....

Genuine Singer Needles should be used in this machine. Their containers are marked with the Company's Trade Mark "SIMANCO."¹

Needles in Containers marked "For Singer Machines" are not Singer made needles. 2

**LIST OF PARTS COMPLETE
FOR**

**MACHINE No. 81-52**

FOR TRIMMING AND OVEREDGING FLANNELS, MUSLIN, DENIM AND OTHER SIMILAR MATERIALS; ALSO FOR RAYON WHERE A GATHERING FEED IS NOT REQUIRED. INSERTING SLEEVES IN WAISTS, WRAPPERS, ETC.; ALSO FOR STITCHING POCKETS IN TROUSERS.

BIGHT ADJUSTABLE FROM $\frac{5}{32}$ TO $\frac{7}{32}$ INCH. THREE-THREAD STITCH. FOOT LIFTER.

HAS AN IMPROVED OILING SYSTEM WHICH AUTOMATICALLY OILS ALL OF THE PRINCIPAL BEARINGS OF THE MACHINE.

BALANCE WHEEL 132632. DIAMETER OF BELT GROOVE $1\frac{7}{8}$ INCHES. SPEED 5000.

NO.	PLATE	NAME
*132522	—	Arm with 42253, 132580 and two each 462c, 624c and 132589.....
4389	7416	Arm Dowel Pin.....

NO.	PLATE	NAME
68350	7416	Arm Oil Cup.....
949E	7417	" Screw.....
132632	20776	Balance Wheel, 1 7/8 in. pulley, with 446c and 1285c.....
1285c	7418	Balance Wheel Position Screw.....
446c	7409	" " Set Screw.....
132524	20777	Cloth Plate with 132525.....
132601	20777	" " Extension (lower).....
233E	7416	" " " " Screw....
42108	7416	" " " (upper).....
233E	7416	" " " " Screw....
*132525	-----	" " Hinge Bracket.....
132526	7416	" " " Stud.....
50150c	7416	" " " " Set Screw.....
42005	7416	" " Lock Spring.....
236c	7416	" " " " Screw.....
132527	-----	Cloth Plate complete, Nos. 42005, 42108, 132524, 132601, two 236c and five 233E.....
42006	7415	Feed Bar with 1253c.....
132641	-----	" " 42006 with 132539.....
132528	7406	" " Hinge Pin.....
1253c	7406	" " " " Set Screw.....
132529	7407	" Connecting Rod with 171c, 1695J, 132530 and two 1057E.....
132619	-----	Feed Connecting Rod 132529 with 132534.....
*132530	-----	Feed Connecting Rod Cap.....
1057E	7407	" " " " Screw.....
51292c	7407	" " " Hinge Screw.....
171c	7407	" " " " " " Clamping Screw.....
1695J	7407	Feed Connecting Rod Hinge Screw Clamping Screw Nut.....
1520J	7407	Feed Connecting Rod Hinge Screw Nut.....
42165	7421	" Dog, 24 teeth (16 teeth to the inch).....
190J	7406	" " Screw.....
*132531	-----	" Eccentric.....
*132532	-----	" " Body.....
1036c	7407	" " " Set Screw.....
19047	7407	" " Clamping Washer.....
201J	7407	" " " " Screw.....
132533	7407	" " Oil Tube.....
132534	7407	Feed Eccentric complete, Nos. 201J, 19047, 51145c, 132531 to 132533, 132628 and two 1036c.....
132651	7407	Feed Eccentric Cover.....

NO.	PLATE	NAME
50253J	7407	Feed Eccentric Cover Screw.....
132536	7408	" " Lubricator with 132537.....
132537	7408	" " " Oil Wick (braided cotton).....
132649	7408	Feed Lifting Eccentric with two 462c....
132539	7408	" " " Connection.....
462c	7408	" " " Set Screw.....
51145c	7407	" Regulating Screw.....
132628	7407	" " " Washer.....
132625	7415	" Rock Shaft.....
132626	-----	Feed Rock Shaft complete, Nos. 42021 and 132625.....
42021	7408	Feed Rock Shaft Crank with 157E.....
157E	7408	" " " " Clamping Screw.....
132542	7408	" " " Hinge Pin with 132544.....
132543	7408	" " " " " Bushing....
132544	7408	" " " " " " Oil Wick (braided cotton).....
1036c	7407	Feed Rock Shaft Hinge Pin Bushing Set Screw.....
132544	7408	Feed Rock Shaft Hinge Pin Oil Wick (braided cotton).....
*132545	-----	Frame.....
132546	20777	" Bottom Cover with 132594.....
132547	20777	" " " Gasket.....
190E	7406	" " " Screw.....
132548	7416	" Oil Cup.....
132549	20776	" Rotary Shaft with 132558 and 132559.....
132616	-----	Frame Rotary Shaft 132549 with 132573 and 132585.....
132550	7416	Frame Rotary Shaft Bushing (front) with 132552.....
132552	7411	Frame Rotary Shaft Bushing (front) Oil Pad (braided cotton).....
132551	7416	Frame Rotary Shaft Bushing (front) Oil Wick (braided cotton).....
1439c	7416	Frame Rotary Shaft Bushing (front) Set Screw.....
132553	7408	Frame Rotary Shaft Crank with 1036c and 1375c.....
1375c	7408	Frame Rotary Shaft Crank Position Screw.....
1036c	7408	" " " " Set Screw....
132554	20776	" " " Flanged Bushing (back) with 132555, 132556 and 132603.....
132555	7415	Frame Rotary Shaft Flanged Bushing (back) Oil Pad, large (braided cotton).....

NO.	PLATE	NAME
132556	7416	Frame Rotary Shaft Flanged Bushing (back) Oil Pad, small (braided cotton)
132603	7415	Frame Rotary Shaft Flanged Bushing (back) Oil Pad Retainer.....
132551	7416	Frame Rotary Shaft Flanged Bushing (back) Oil Wick (braided cotton)....
1439c	7416	Frame Rotary Shaft Flanged Bushing (back) Set Screw.....
132558	7415	Frame Rotary Shaft Oil Pad (braided cotton).....
132559	7415	Frame Rotary Shaft Oil Pad Retainer..
132560	20776	" Side Cover (left) with 19045....
19045	7416	" " " " Handle.....
330w	7416	" " " " Screw.....
42028	20776	" " " (right) hinged.....
42101	7416	" " " " Lock Spring..
330w	7416	" " " " Screw.....
132561	20777	" Top Cover.....
132650	7409	" " " Extension.....
42102	7409	" " " " Holder.....
132600	-----	" " " " " 42102 with 42101, 132650, 132651 and two each 190j and 50253j.....
283w	7409	Frame Top Cover Extension Holder Thumb Screw.....
2749	7409	Frame Top Cover Extension Holder Thumb Screw Washer.....
190j	7406	Frame Top Cover Extension Screw.....
583F	7417	" " " " Screw (large).....
742F	7417	" " " " (small).....
42213	7409	Knife (movable).....
NOTE: Two No. 42213 are sent with this machine		
42214	7409	Knife (movable) Gib.....
42035	7409	" " " Holder.....
132627	-----	" " " 42035 with 133F, 42037, 42040, 42214 and two 404E....
42037	7409	Knife (movable) Holder Cap.....
404E	7409	" " " " Screw.....
42038	7409	" " " " Guide with 336F
42039	7409	" " " " P l a t e
621E	7409	" " " " " " Screw.....
336F	7409	Knife (movable) Holder Guide Set Screw
133F	7409	" " " " Screw.....
42040	7409	" " " " Extension Pin.....

NO.	PLATE	NAME
42041	7409	Knife (movable) Holder Spring.....
132562	7410	" " " Lever with 175E.....
132563	7410	" " " " Connection with 132564 and two 1057E.....
132620	-----	Knife (movable) Lever Connection 132563 with 132649.....
*132564	-----	Knife (movable) Lever Connection Cap
1057E	7410	" " " " " " " " Screw.....
132565	7410	Knife (movable) Lever Connection Hinge Stud.....
175E	7410	Knife (movable) Lever Connection Hinge Stud Set Screw.....
42045	7410	Knife (movable) Lever Hinge Stud.....
1229c	7410	" " " " " " Set Screw.....
42046	7410	Knife (stationary) with 42049.....
NOTE: Two No. 42046 are sent with this machine		
42048	7410	Knife (stationary) Clamping Stud.....
1534D	7410	" " " " " Thumb Nut.....
42156	7410	Knife (stationary) Holder.....
1376c	7417	" " " " " Regulating Thumb Screw.....
1101c	7418	Knife (stationary) Holder Screw.....
440c	7409	" " " " " Stop Screw
1547j	7409	" " " " " " " " Nut.....
42049	7410	Knife (stationary) Stud.....
42050	7411	Looper (left hand).....
132566	7411	" " " " Lever with 50117c and two 1253c.....
132567	7411	Looper (left hand) Lever Connecting Stud.....
132645	7411	Looper (left hand) Lever Connecting Stud Hinge Pin.....
1253c	7411	Looper (left hand) Lever Connecting Stud Hinge Pin Set Screw.....
132569	7411	Looper (left hand) Lever Hinge Stud with 132552.....
132552	7411	Looper (left hand) Lever Hinge Stud Oil Pad (braided cotton).....
132571	7411	Looper (left hand) Lever Hinge Stud Oil Wick (braided cotton).....
1036c	7408	Looper (left hand) Lever Hinge Stud Set Screw.....

NO.	PLATE	NAME
50117c	7411	Looper (left hand) Set Screw.....
132630	7411	“ (right hand).....
132572	7411	“ “ “ and Spreader Lever with 50200c.....
132573	7412	Looper (right hand) and Spreader Lever Ball Stud.....
50200c	7413	Looper (right hand) and Spreader Lever Ball Stud Set Screw.....
132574	7412	Looper (right hand) and Spreader Lever Connection with 132575, 132576 and four 1057E.....
132617	——	Looper (right hand) and Spreader Lever Connection 132574 with 132553 and 132573.....
*132575	——	Looper (right hand) and Spreader Lever Connection Cap (lower).....
1057E	7412	Looper (right hand) and Spreader Lever Connection Cap (lower) Screw.....
*132576	——	Looper (right hand) and Spreader Lever Connection Cap (upper).....
1057E	7412	Looper (right hand) and Spreader Lever Connection Cap (upper) Screw.....
132577	7412	Looper (right hand) and Spreader Lever Connection Guide.....
196F	7412	Looper (right hand) and Spreader Lever Connection Guide Screw.....
132578	7412	Looper (right hand) and Spreader Lever Hinge Pin with 132579.....
132543	7408	Looper (right hand) and Spreader Lever Hinge Pin Bushing.....
132579	7412	Looper (right hand) and Spreader Lever Hinge Pin Bushing Oil Wick (braided cotton).....
1036c	7408	Looper (right hand) and Spreader Lever Hinge Pin Bushing Set Screw.....
132579	7412	Looper (right hand) and Spreader Lever Hinge Pin Oil Pad (braided cotton).....
1036c	7408	Looper (right hand) and Spreader Lever Hinge Pin Set Screw.....
197J	7411	Looper (right hand) Screw.....
42054	7412	Needle Bar.....
42253	7412	“ “ Bushing (lower).....
132580	7412	“ “ “ (upper).....
132581	7412	“ “ “ “ Oil Pad (braided cotton).....
132621	7412	Needle Bar Bushing (upper) Oil Pad Cover.....

NO.	PLATE	NAME
217J	7412	Needle Bar Bushing (upper) Oil Pad Cover Screw.....
462c	7408	Needle Bar Bushing Set Screw.....
132598	7412	“ “ Connecting Bracket with 187E and 223F.....
187E	7412	Needle Bar Connecting Bracket Clamping Screw.....
132582	7412	Needle Bar Connecting Link.....
132583	7412	“ “ “ “ Hinge Pin with 132584.....
132584	7412	Needle Bar Connecting Link Hinge Pin Oil Pad (wick).....
223F	7412	Needle Bar Connecting Link Hinge Pin Set Screw for 132598.....
620c	7413	Needle Bar Connecting Link Hinge Pin Set Screw for 132597.....
132585	7413	Needle Bar Connecting Rod with 132586, 132587 and four 1057E.....
*132586	——	Needle Bar Connecting Rod Cap (lower)
1057E	7413	“ “ “ “ “ “ “ Screw.....
*132587	——	Needle Bar Connecting Rod Cap (upper)
1057E	7413	“ “ “ “ “ “ “ Screw.....
132577	7412	Needle Bar Connecting Rod Guide.....
196F	7412	“ “ “ “ “ “ Screw
132588	7413	“ “ Crank (back) with 132590 and two 1259c.....
132573	7412	Needle Bar Crank (back) Ball Stud.....
1259c	7413	“ “ “ “ “ “ Set Screw.....
132589	7413	Needle Bar Crank (back) Bushing.....
624c	7413	“ “ “ “ “ “ Set Screw.....
132590	7413	Needle Bar Crank (back) Oil Pad (wick)
1259c	7413	“ “ “ “ “ Set Screw.....
132597	7413	“ “ “ (front) with 620c, 1259c and 50200c.....
132615	——	Needle Bar Crank (front) 132597 with 132582, 132598 and two 132583.....
1259c	7413	Needle Bar Crank (front) Position Screw
50200c	7413	“ “ “ “ Set Screw.....
42115	7413	“ “ Thread Retainer Bracket.....
42483	7413	“ “ “ “ Disc.....
93c	7413	“ “ “ “ Screw.....
10107	7413	“ “ “ “ Spring.....
1728c	7412	“ Clamping Nut.....

NO.	PLATE	NAME
42066	7413	Needle Guard.....
171F	7413	“ “ Screw.....
42168	7421	Presser Foot Chaining-off Finger.....
233J	7420	“ “ “ “ Screw.....
132609	-----	“ “ “ “ Plate.....
132610	7420	“ “ “ “ Collar with 240c.....
132611	7420	Presser Foot Chaining-off Plate Collar Guide Pin.....
735c	7420	Presser Foot Chaining-off Plate Collar Guide Pin Set Screw.....
240c	7420	Presser Foot Chaining-off Plate Collar Set Screw.....
62527	7420	Presser Foot Hinge Pin.....
132648	-----	“ “ Plate.....
132612	-----	“ “ Shank with 735c.....
14058	7420	“ “ Spring.....
132646	7421	Presser Foot (spring hinged) complete, Nos. 233J, 14058, 42168, 62527, 132609 to 132612 and 132648.....
1324c	7420	Presser Foot Screw.....
39541	7420	“ “ “ Washer.....
42069	20776	“ Lever.....
42045	7410	“ “ Hinge Stud.....
1120c	7417	“ “ “ “ Set Screw.....
42070	7414	“ “ Lifter.....
85D	7414	“ “ “ Hinge Screw.....
1377c	7418	“ “ Screw Stud (eccentric).....
1547J	7409	“ “ “ Nut.....
42071	7414	“ “ Spring.....
1378D	7414	Pressure Regulating Thumb Screw.....
132631	7411	Spreader.....
197J	7411	“ Screw.....
2102	7414	Tension (looper, left hand) Disc.....
1560c	7414	“ “ “ “ Regulating Thumb Nut.....
50148c	7414	Tension (looper, left hand) Screw Stud
124687	-----	“ “ “ “ “ “ “ 50148c with 1560c.....
54883	7414	Tension (looper, left hand) Spring.....
132599	7414	“ “ “ “ Thread Guide
2102	7414	“ (looper, right hand) Disc.....
1560c	7414	“ “ “ “ Regulating Thumb Nut.....
828c	7414	Tension (looper, right hand) Screw Stud
42418	-----	“ “ “ “ “ “ “ 828c with 1560c.....

NO.	PLATE	NAME
10148	7414	Tension (looper, right hand) Spring.....
57076	7414	“ “ “ “ Thread Guide
2102	7414	“ (needle thread) Disc.....
1560c	7414	“ “ “ “ Regulating Thumb Nut.....
916c	7414	Tension (needle thread) Screw Stud....
44209	-----	“ “ “ “ “ “ 916c with 1560c.....
10148	7414	Tension (needle thread) Spring.....
42082	7414	“ “ “ “ Thread Guide..
132629	7417	Thread (looper, left hand) Eyelet.....
233J	7416	“ “ “ “ “ “ Screw
42122	7417	“ “ “ “ Nipper Spring (lower).....
42123	7417	Thread (looper, left hand) Nipper Spring (upper).....
176J	7417	Thread (looper, left hand) Nipper Spring Screw.....
42084	7417	Thread (looper, left hand) Tube.....
462c	7408	“ “ “ “ “ “ Set Screw
42126	7417	“ “ “ “ “ “ Pull-off.....
132591	7417	“ (looper, right hand) Pull-off.....
12244	7417	“ “ “ “ “ “ Eyelet
207J	7417	“ “ “ “ “ “ “ Screw.....
42093	7417	Thread (looper, right hand) Staple.....
190J	7406	“ “ “ “ “ “ Screw
42127	7417	“ “ “ “ “ “ Take-up
197J	7414	“ “ “ “ “ “ “ Screw.....
132622	7417	Thread (needle) Eyelet.....
223J	7412	“ “ “ “ Screw.....
132623	7417	“ “ “ “ Take-up.....
197J	7414	“ “ “ “ “ “ Screw.....
42171	7421	Throat Plate for 42165.....
742F	7417	“ “ “ “ Screw.....

FITTINGS FOR 81-52 MACHINE

FOR RAYON

FOR THREE-THREAD TIGHT STITCH

NO.	PLATE	NAME
132607	7420	Feed Dog, 34 teeth (22 teeth to the inch)
42050	7411	Looper (left hand).....
132630	7411	“ (right hand).....

NO.	PLATE	NAME
132608	7420	Presser Foot Chaining-off Finger.....
233 _r	7420	“ “ “ “ Screw
132609	—	“ “ “ “ Plate.....
132610	7420	“ “ “ “ Collar with 240c.....
132611	7420	Presser Foot Chaining-off Plate Collar Guide Pin.....
735c	7420	Presser Foot Chaining-off Plate Collar Guide Pin Set Screw.....
240c	7420	Presser Foot Chaining-off Plate Collar Set Screw.....
62527	7420	Presser Foot Hinge Pin.....
132648	—	“ “ Plate.....
132612	—	“ “ Shank with 735c.....
14058	7420	“ “ Spring.....
132613	7420	Presser Foot (spring hinged) complete, Nos. 233 _r , 14058, 62527, 132608 to 132612 and 132648.....
132614	7420	Throat Plate for 132607.....

FOR TWO-THREAD STITCH

132607	7420	Feed Dog, 34 teeth (22 teeth to the inch)
42050	7411	Looper (left hand).....
132613	7420	Presser Foot (spring hinged) complete, Nos. 233 _r , 14058, 62527, 132608 to 132612 and 132648.....
132631	7411	Spreader.....
132614	7420	Throat Plate for 132607.....

FOR PLAIN WORK**FOR 1/8 INCH BIGHT. FOR THREE-THREAD STITCH**

NO.	PLATE	NAME
42109	7423	Feed Dog, 24 teeth (16 teeth to the inch)
42050	7411	Looper (left hand).....
132630	7411	“ (right hand).....
42118	7423	Presser Foot Chaining-off Finger.....
233 _r	7420	“ “ “ “ Screw
132609	—	“ “ “ “ Plate.....
132610	7420	“ “ “ “ Collar with 240c.....
132611	7420	Presser Foot Chaining-off Plate Collar Guide Pin.....
735c	7420	Presser Foot Chaining-off Plate Collar Guide Pin Set Screw.....
240c	7420	Presser Foot Chaining-off Plate Collar Set Screw.....

NO.	PLATE	NAME
62527	7420	Presser Foot Hinge Pin.....
132648	—	“ “ Plate.....
132612	—	“ “ Shank with 735c.....
14058	7420	“ “ Spring.....
132633	7423	Presser Foot (spring hinged) complete, Nos. 233 _r , 14058, 42118, 62527, 132609 to 132612 and 132648.....
42134	7423	Throat Plate for 42109.....

FOR TWO-THREAD STITCH

42109	7423	Feed Dog, 24 teeth (16 teeth to the inch)
42050	7411	Looper (left hand).....
132633	7423	Presser Foot (spring hinged) complete, Nos. 233 _r , 14058, 42118, 62527, 132609 to 132612 and 132648.....
132631	7411	Spreader.....
42134	7423	Throat Plate for 42109.....

FOR PANTS POCKETS**FOR 5/32 IN. TO 7/32 IN. BIGHT. FOR THREE-
THREAD STITCH**

NO.	PLATE	NAME
42165	7421	Feed Dog, 24 teeth (16 teeth to the inch)
42050	7411	Looper (left hand).....
132630	7411	“ (right hand).....
132646	7421	Presser Foot (spring hinged) complete, Nos. 233 _r , 14058, 42168, 62527, 132609 to 132612 and 132648.....
42171	7421	Throat Plate for 42165.....

ACCESSORIES

NO.	PLATE	NAME
1407E	5563	Machine Base Thumb Screw, for 3 in. table.....
1408E	5563	Machine Base Thumb Screw, for 2 in. table.....
14063	7418	Machine Base Thumb Screw Spring
9842	7419	“ “ “ “ “ Washer.....
132602	7418	Machine Base Thumb Screw Washer...
120344	5566	Oiler (copper plated) with 120345.....
120345	5566	“ Spout, 5 in. long.....
120440	5566	Screw Driver.....
42090	5566	Threading Wire.....

NO.	PLATE	NAME
120341	5566	Tweezers (curved).....
68547	7418	Wrench for 1324 and 1728.....
8908	5566	" " 1520.....
4822	5566	" " 1547.....

BENCH STAND

NO.	PLATE	NAME
79768	-----	Bench Stand with 27998, two each 28291, 46548, wood screws 1½ in. No. 14 and eight wood screws 5/8 in. No. 5 ..
28291	7418	Cover Hinge.....
27998	7418	" Hook and Eye (brass) with wood screw ½ in. No. 5.....
46548	7418	Cover Rest (felt).....

FOOT LIFTER PARTS

NO.	PLATE	NAME
6439	-----	Chain, 36 in. to 45 in., with 56864 and 56865.....

NOTE: When ordering No. 6439, state length required

4879	5566	Chain Connecting Link.....
56864	5566	" Hook (large).....
56865	7418	" " (small).....
42130	7415	Lifting Lever.....
42131	7415	" " Bracket.....
1229c	7410	" " " Screw.....
1301D	7415	" " Hinge Screw.....
42132	7415	" " Spring.....
1148F	7415	" " Stop Screw.....
1547J	7409	" " " Nut.....
4881	20777	Treadle.....
4882	5566	" Shaft.....
4883	5566	" Spring.....
4884	20777	" Stand.....
4885	20777	Treadle complete, Nos. 4879, 4881 to 4884 and two wood screws 1 in. No. 16
42133	-----	Foot Lifter complete, Nos. 1301D, 4885, 6439, 42130 to 42132 and two each 1148F, 1229c and 1547J

KNEE LIFTER PARTS

NO.	PLATE	NAME
42130	7415	Lifting Lever.....
42131	7415	" " Bracket.....
1229c	7410	" " " Screw.....
42142	20777	" " Connecting Rod.....
1301D	7415	" " Hinge Screw.....
42132	7415	" " Spring.....
1148F	7415	" " Stop Screw.....
1547J	7409	" " " " Nut.....
2763	20777	Rock Shaft.....
12242	20777	" " Hanger with two wood screws 1 in. No. 10.....
2765	20777	Rock Shaft Knee Arm.....
2766	20777	" " " " Hub with 356c.....
356c	7418	" " " " " Set Screw.....
2768	-----	Rock Shaft Knee Arm complete, Nos. 2765 to 2767.....
2767	20777	Rock Shaft Knee Plate with 356c.....
356c	7418	" " " " " Set Screw.....
6337	20777	" " Lifting Bracket with two 356c.....
7125	20777	Rock Shaft Lifting Bracket Hook.....
356c	7418	" " " " " " Set Screw.....
356c	7418	Rock Shaft Lifting Bracket Set Screw.....
2770	20777	" " Stop Dog with 356c.....
356c	7418	" " " " " Set Screw.....
42143	20777	Rock Shaft complete, Nos. 2763, 2768, 6337, 7125 and two each 2770 and 12242.....
42144	-----	Knee Lifter complete, Nos. 1301D, 42130 to 42132, 42142, 42143 and two each 1148F, 1229c and 1547J.....

KNIFE GRINDER

NO.	PLATE	NAME
41326	5568	Emery Wheel.....
1508c	5569	" " Clamping Nut.....
41327	5568	" " Shaft.....
41328	5568	" " " Pulley with 1036c.....
1036c	5569	" " " " " Set Screw.....
41513	5569	" " Washer.....
41329	5567	Frame with 1036c.....
878D	5569	" Oil Hole Stop Screw.....

NO.	PLATE	NAME
41330	5568	Knife Holder with two 14222
150209	—	“ “ 41339 with 970b, 41331, 41332 and two each 313c, 771b, 1519i, 41333 and 41334
41331	5568	Knife Holder Bracket with 157E
157E	5569	“ “ “ Clamping Screw
42065	5569	“ “ “ Hinge Stud
1036c	5569	“ “ “ “ “ Set Screw
717c	5569	Knife Holder Bracket Stop Screw
1520i	5569	“ “ “ “ Nut
41333	5569	“ “ Clamp
41334	5569	“ “ Spring
14222	5569	“ “ “ Steady Pin
771b	5569	“ “ “ Thumb Screw
970b	5569	“ “ “ Regulating Thumb Screw
313c	5569	“ “ “ Screw Center
1519i	5569	“ “ “ “ Nut
41332	5569	“ “ “ Spring
41335	—	Knife Grinder complete, Nos. 717c, 1508c, 1520i, 41326 to 41329, 42065, 150209, two each 878b and 41513 and three wood screws 1¼ in. No. 12

MACHINE BASE

NO.	PLATE	NAME
132647	20777	Machine Base
132595	7419	“ “ Cushion (large) felt
42088	7419	“ “ “ (small) felt
132618	7419	“ “ “ “ “ for 1407 or 1408
935E	7419	Machine Base Cushion (small) Screw
132596	7419	“ “ “ (leather)
132593	7419	“ “ Oil Drain Strainer
131019	20776	“ “ “ Pipe
131020	20776	“ “ “ Valve
54477	7419	“ “ “ Screw Stud
51576E	7419	“ “ “ “ Nut
9842	7419	“ “ “ “ Washer
132594	7419	“ “ “ Thumb Screw Bushing
132592	—	Machine Base complete, Nos. 131019, 131020, 132593, 132596, 132618, 132647 three each 9842, 51576E, 54477 and four each 935E, 42088 and 132595

THREAD UNWINDER

FOR THREE SPOOLS

NO.	PLATE	NAME
225259	20778	Spool Rest (for one spool) with 201018c
225257	20778	“ “ (for two spools) with 201018c
150203	—	“ “ Cushion (felt)
225388	20778	“ “ Rod
200383c	7418	“ “ “ Set Screw
201018c	7418	“ “ Set Screw
202490	20778	“ Stand with 200383c
225391	20778	Thread Guide
201696i	7418	“ “ Lock Nut
225326	7418	“ “ Position Cup
225324	20778	“ “ Rod with 208E and 225322
208E	7409	“ “ “ Screw
225322	7418	“ “ “ Washer
*150057	—	“ Separator
150058	20778	“ “ 150057 with 150059
*150059	—	“ “ Bracket
150060	20778	“ “ “ Arm with 164j and 9525
164j	7418	Thread Separator Bracket Arm Clamp- ing Screw
9525	7418	Thread Separator Bracket Arm Clamp- ing Screw Washer
164j	7418	Thread Separator Bracket Screw
9525	7418	“ “ “ “ Washer
150061	—	Thread Separator complete, Nos. 164j, 9525, 150058 and 150060
150178	20778	Thread Unwinder complete, Nos. 150061, 201696i, 202490, 225257, 225259, 225324, 225326, 225388 and three each 150203, 225391 and wood screws ¾ in. No. 12
27739	7234	Thread Cone (wood) for large cones
225390	7234	“ “ “ Holder, for inverted cones

NOTE: Nos. 27739 and 225390 are used with,
but not included in 150178.

**Genuine Singer Needles should be used
in this machine.
Their containers are marked with the
Company's Trade Mark "SIMANCO."**

**Needles in Containers marked
"For Singer Machines"
are not Singer made needles.**

2

NUMERICAL LIST OF PARTS

FOR

MACHINES

Nos. 81-50 and 81-52

NUMERICAL LIST OF PARTS

NO.	PLATE	NAME
61c	7406	Feed (back) Bar Hinge Screw for 81-50 Machine.....
85D	7414	Presser Lever Lifter Hinge Screw.....
93c	7413	Needle Bar Thread Retainer Screw.....
133F	7409	Knife (movable) Holder Screw for 132627
157E	7408	Feed Rock Shaft Crank Clamping Screw for 42021.....
157E	7408	Feed (front) Rock Shaft Crank Clamping Screw for 42021.....
157E	5569	Knife Grinder Knife Holder Bracket Clamping Screw for 41331.....
164J	7418	Thread Unwinder Thread Separator Bracket Arm Clamping Screw for 150060.....
164J	7418	Thread Unwinder Thread Separator Bracket Screw for 150061.....
171c	7407	Feed Connecting Rod Hinge Screw Clamping Screw for 132529.....
171c	7407	Feed (front) Connecting Rod Hinge Screw Clamping Screw for 132529.....
171F	7413	Needle Guard Screw.....
175E	7410	Knife (movable) Lever Connection Hinge Stud Set Screw for 132562.....
176J	7417	Thread (looper, left hand) Nipper Spring Screw.....
187E	7412	Needle Bar Connecting Bracket Clamping Screw for 132598.....
190J	7406	Feed (back) Regulator Set Screw for 81-50 Machine.....
190J	7406	Feed Dog Screw.....
190E	7406	Frame Bottom Cover Screw.....
190J	7406	" Top Cover Extension Screw for 132600.....
190J	7406	Thread (looper, right hand) Staple Screw
196F	7412	Looper (right hand) and Spreader Lever Connection Guide Screw.....
196F	7412	Needle Bar Connecting Rod Guide Screw
197J	7411	Looper (right hand) Screw.....
197J	7411	Spreader Screw.....
197J	7414	Thread (looper, right hand) Take-up Screw.....
197J	7414	Thread (needle) Take-up Screw.....
201J	7407	Feed Eccentric Clamping Washer Screw for 132534.....

NUMERICAL LIST OF PARTS

FOR

MACHINES

81-50 and 81-55

NO.	PLATE	NAME
201J	7407	Feed (front) Eccentric Clamping Washer Screw for 132534.....
207J	7417	Thread (looper, right hand) Pull-off Eyelet Screw.....
208E	7409	Thread Unwinder Thread Guide Rod Screw for 225324.....
217J	7412	Needle Bar Bushing (upper) Oil Pad Cover Screw.....
223F	7412	Needle Bar Connecting Link Hinge Pin Set Screw for 132598.....
223J	7412	Thread (needle) Eyelet Screw.....
233E	7416	Cloth Plate Extension (lower) Screw for 132527.....
233E	7416	Cloth Plate Extension (upper) Screw for 132527.....
233J	7420	Presser Foot Chaining-off Finger Screw for 42265, 42420, 132613, 132633 and 132646.....
233J	7416	Thread (looper, left hand) Eyelet Screw
236c	7416	Cloth Plate Lock Spring Screw for 132527
240c	7420	Presser Foot Chaining-off Plate Collar Set Screw for 132610.....
283w	7409	Frame Top Cover Extension Holder Thumb Screw.....
313c	5569	Knife Grinder Knife Holder Screw Center for 150209.....
330w	7416	Frame Side Cover (left) Screw.....
330w	7416	" " " (right) Screw.....
336F	7409	Knife (movable) Holder Guide Set Screw for 42038.....
356c	7418	Rock Shaft Knee Arm Hub Set Screw for 2766.....
356c	7418	Rock Shaft Knee Plate Set Screw for 2767.....
356c	7418	Rock Shaft Lifting Bracket Hook Set Screw for 6337.....
356c	7418	Rock Shaft Lifting Bracket Set Screw for 6337.....
356c	7418	Rock Shaft Stop Dog Set Screw for 2770
404E	7409	Knife (movable) Holder Cap Screw for 132627.....
440c	7409	Knife (stationary) Holder Stop Screw..
446c	7409	Balance Wheel Set Screw for 132632...
462c	7408	Feed Lifting Eccentric Set Screw for 132649.....
462c	7408	Feed (front) Lifting Eccentric Set Screw for 132649.....

NO.	PLATE	NAME
462c	7408	Needle Bar Bushing Set Screw for 132522
462c	7408	Thread (looper, left hand) Tube Set Screw.....
464c	7424	Presser Foot Plate (back) Spring Adjusting Pin Set Screw for 42265 and 42420
583F	7417	Frame Top Cover Screw (large).....
620c	7413	Needle Bar Connecting Link Hinge Pin Set Screw for 132597.....
621E	7409	Knife (movable) Holder Guide Plate Screw.....
624c	7413	Needle Bar Crank (back) Bushing Set Screw for 132522.....
717c	5569	Knife Grinder Knife Holder Bracket Stop Screw for 41335.....
735c	7420	Presser Foot Chaining-off Plate Collar Guide Pin Set Screw for 132612.....
742F	7417	Frame Top Cover Screw (small).....
742F	7417	Throat Plate Screw.....
771D	5569	Knife Grinder Knife Holder Clamp Thumb Screw for 150209.....
828c	7414	Tension (looper, right hand) Screw Stud for 42418.....
878D	5569	Knife Grinder Frame Oil Hole Stop Screw for 41335.....
916c	7414	Tension (needle thread) Screw Stud for 44209.....
935E	7419	Machine Base Cushion (small) Screw for 132592.....
949E	7417	Arm Screw.....
970D	5569	Knife Grinder Knife Holder Regulating Thumb Screw for 150209.....
1036c	7407	Feed Eccentric Body Set Screw for 132534.....
1036c	7407	Feed (front) Eccentric Body Set Screw for 132534.....
1036c	7407	Feed Rock Shaft Hinge Pin Bushing Set Screw for 81-52 Machine.....
1036c	7407	Feed (front) Rock Shaft Hinge Pin Bushing Set Screw for 81-50 Machine
1036c	7408	Frame Rotary Shaft Crank Set Screw for 132553.....
1036c	7408	Looper (left hand) Lever Hinge Stud Set Screw.....
1036c	7408	Looper (right hand) and Spreader Lever Hinge Pin Bushing Set Screw.....
1036c	7408	Looper (right hand) and Spreader Lever Hinge Pin Set Screw.....

NO.	PLATE	NAME
1036c	5569	Knife Grinder Emery Wheel Shaft Pulley Set Screw for 41328.....
1036c	5569	Knife Grinder Knife Holder Bracket Hinge Stud Set Screw for 41329.....
1057E	7407	Feed Connecting Rod Cap Screw for 132529.....
1057E	7407	Feed (front) Connecting Rod Cap Screw for 132529.....
1057E	7410	Knife (movable) Lever Connection Cap Screw for 132563.....
1057E	7412	Looper (right hand) and Spreader Lever Connection Cap (lower) Screw for 132574.....
1057E	7412	Looper (right hand) and Spreader Lever Connection Cap (upper) Screw for 132574.....
1057E	7413	Needle Bar Connecting Rod Cap (lower) Screw for 132585.....
1057E	7413	Needle Bar Connecting Rod Cap (upper) Screw for 132585.....
1101c	7418	Knife (stationary) Holder Screw.....
1120c	7417	Presser Lever Hinge Stud Set Screw....
1132c	7406	Feed (back) Connecting Link Hinge Screw for 81-50 Machine.....
1132c	7406	Feed (back) Regulator Hinge Screw for 81-50 Machine.....
1148F	7415	Lifting Lever Stop Screw for 42133 and 42144.....
1229c	7410	Knife (movable) Lever Hinge Stud Set Screw.....
1229c	7410	Lifting Lever Bracket Screw for 42133 and 42144.....
1253c	7406	Feed Bar Hinge Pin Set Screw for 42006
1253c	7406	" (front) Bar Hinge Pin Set Screw for 42151.....
1253c	7411	Looper (left hand) Lever Connecting Stud Hinge Pin Set Screw for 132566
1259c	7413	Needle Bar Crank (back) Ball Stud Set Screw.....
1259c	7413	Needle Bar Crank (back) Set Screw for 132588.....
1259c	7413	Needle Bar Crank (front) Position Screw for 132597.....
1285c	7418	Balance Wheel Position Screw for 132632
1301D	7415	Lifting Lever Hinge Screw for 42133 and 42144.....
1324c	7420	Presser Foot Screw.....

NO.	PLATE	NAME
1375c	7408	Frame Rotary Shaft Crank Position Screw for 132553.....
1376c	7417	Knife (stationary) Holder Regulating Thumb Screw.....
1377c	7418	Presser Lever Screw Stud (eccentric)....
1378D	7414	Pressure Regulating Thumb Screw.....
1407E	5563	Machine Base Thumb Screw, for 3 in. table (Accessories).....
1408E	5563	Machine Base Thumb Screw, for 2 in. table (Accessories).....
1439c	7416	Frame Rotary Shaft Bushing (front) Set Screw.....
1439c	7416	Frame Rotary Shaft Flanged Bushing (back) Set Screw.....
1444c	7406	Feed (back) Regulator Thumb Screw for 132541.....
1508c	5569	Knife Grinder Emery Wheel Clamping Nut for 41335.....
1519J	5569	Knife Grinder Knife Holder Screw Center Nut for 150209.....
1520J	7407	Feed Connecting Rod Hinge Screw Nut for 81-52 Machine.....
1520J	7407	Feed (front) Connecting Rod Hinge Screw Nut for 81-50 Machine.....
1520J	5569	Knife Grinder Knife Holder Bracket Stop Screw Nut for 41335.....
1534D	7410	Knife (stationary) Clamping Stud Thumb Nut.....
1547J	7409	Knife (stationary) Holder Stop Screw Nut.....
1547J	7409	Lifting Lever Stop Screw Nut for 42133 and 42144.....
1547J	7409	Presser Lever Screw Stud Nut.....
1560c	7414	Tension (looper, left hand) Regulating Thumb Nut for 124687.....
1560c	7414	Tension (looper, right hand) Regulating Thumb Nut for 42418.....
1560c	7414	Tension (needle thread) Regulating Thumb Nut for 44209.....
1695J	7407	Feed Connecting Rod Hinge Screw Clamping Screw Nut for 132529.....
1695J	7407	Feed (front) Connecting Rod Hinge Screw Clamping Screw Nut for 132529
1728c	7412	Needle Clamping Nut.....

NO.	PLATE	NAME
2102	7414	Tension (looper, left hand) Disc.....
2102	7414	" (looper, right hand) Disc.....
2102	7414	" (needle thread) Disc.....
2749	7409	Frame Top Cover Extension Holder Thumb Screw Washer.....
2763	20777	Rock Shaft for 42143.....
2765	20777	" " Knee Arm for 2768.....
2766	20777	" " " " Hub with 356c, for 2768.....
2767	20777	Rock Shaft Knee Plate with 356c, for 2768.....
2768	-----	Rock Shaft Knee Arm complete for 42143, Nos. 2765 to 2767.....
2770	20777	Rock Shaft Stop Dog with 356c, for 42143.....
4389	7416	Arm Dowel Pin.....
4822	5566	Wrench for 1547 (Accessories).....
4879	5566	Chain Connecting Link for 4885.....
Nos. 4881 to 4884 FOR 4885		
4881	20777	Treadle.....
4882	5566	" Shaft.....
4883	5566	" Spring.....
4884	20777	" Stand.....
4885	20777	Treadle complete for 42133, Nos. 4879, 4881 to 4884 and two wood screws 1 in. No. 16.....
6337	20777	Rock Shaft Lifting Bracket with two 356c, for 42143.....
6439	-----	Chain, 36 in. to 45 in., with 56864 and 56865, for 42133.....
7125	20777	Rock Shaft Lifting Bracket Hook for 42143.....
8908	5566	Wrench for 1520 (Accessories).....
9320	7424	Presser Foot Plate (back) Hinge Pin for 42265 and 42420.....
9525	7418	Thread Unwinder Thread Separator Bracket Arm Clamping Screw Washer, for 150060.....
9525	7418	Thread Unwinder Thread Separator Bracket Screw Washer for 150061....
9842	7419	Machine Base Thumb Screw Spring Washer (Accessories).....
9842	7419	Machine Base Screw Stud Nut Washer for 132592.....
10107	7413	Needle Bar Thread Retainer Spring....

NO.	PLATE	NAME
10148	7414	Tension (looper, right hand) Spring....
10148	7414	" (needle thread) Spring.....
12242	20777	Rock Shaft Hanger with two wood screws 1 in. No. 10, for 42143.....
14058	7420	Presser Foot Plate (back) Spring for 42265 and 42420.....
14058	7420	Presser Foot Spring for 132613, 132633 and 132646.....
14063	7418	Machine Base Thumb Screw Spring (Accessories).....
14222	5569	Knife Grinder Knife Holder Clamp Steady Pin for 41330.....
19045	7416	Frame Side Cover (left) Handle for 132560.....
19047	7407	Feed Eccentric Clamping Washer for 132534.....
19047	7407	Feed (front) Eccentric Clamping Washer for 132534.....
27739	7234	Thread Unwinder Thread Cone (wood) for large cones, for 150178.....
27998	7418	Bench Stand Cover Hook and Eye (brass) with wood screw 1/2 in. No. 5, for 79768.....
28291	7418	Bench Stand Cover Hinge for 79768....
39541	7420	Presser Foot Screw Washer.....
Nos. 41326 to 41329 FOR 41335		
41326	5568	Knife Grinder Emery Wheel.....
41327	5568	" " " " Shaft.....
41328	5568	" " " " " Pulley with 1036c.....
41329	5567	Knife Grinder Frame with 1036c.....
41330	5568	" " Knife Holder with two 14222, for 150209.....
41331	5568	Knife Grinder Knife Holder Bracket with 157e, for 150209.....
41332	5569	Knife Grinder Knife Holder Spring for 150209.....
41333	5569	Knife Grinder Knife Holder Clamp for 150209.....
41334	5569	Knife Grinder Knife Holder Clamp Spring for 150209.....
41335	-----	Knife Grinder complete, Nos. 717c, 1508c, 1520r, 41326 to 41329, 42065, 150209, two each 878D and 41513 and three wood screws 1 1/4 in. No. 12.....

NO.	PLATE	NAME
41513	5569	Knife Grinder Emery Wheel Washer for 41335
42005	7416	Cloth Plate Lock Spring for 132527
42006	7415	Feed Bar with 1253c, for 132641
42021	7408	Rock Shaft Crank with 157E, for 132626
42021	7408	Feed (front) Rock Shaft Crank with 157E, for 132541
42028	20776	Frame Side Cover (right) hinged
42035	7409	Knife (movable) Holder for 132627
42037	7409	" " " Cap for 132627
42038	7409	" " " Guide with 336F
42039	7409	" " " Plate
42040	7409	" " " Screw Extension Pin for 132627
42041	7409	Knife (movable) Holder Spring
42045	7410	" " Lever Hinge Stud
42045	7410	Presser Lever Hinge Stud
42046	7410	Knife (stationary) with 42049
42048	7410	" " Clamping Stud
42049	7410	" " Stud for 42046
42050	7411	Looper (left hand)
42054	7412	Needle Bar
42065	5569	Knife Grinder Knife Holder Bracket Hinge Stud for 41335
42066	7413	Needle Guard
42069	20776	Presser Lever
42070	7414	" " Lifter
42071	7414	" " Spring
42082	7414	Tension (needle thread) Thread Guide
42084	7417	Thread (looper, left hand) Tube
42088	7419	Machine Base Cushion (small) felt, for 132592
42090	5566	Threading Wire (Accessories)
42093	7417	Thread (looper, right hand) Staple
42101	7416	Frame Side Cover (right) Lock Spring for 132600
42102	7409	Frame Top Cover Extension Holder for 132600
42108	7416	Cloth Plate Extension (upper) for 132527
42109	7423	Feed Dog, 24 teeth (16 teeth to the inch) for 42134, for 81-52 Machine
42115	7413	Needle Bar Thread Retainer Bracket
42118	7423	Presser Foot Chaining-off Finger for 132633
42122	7417	Thread (looper, left hand) Nipper Spring (lower)

NO.	PLATE	NAME
42123	7417	Thread (looper, left hand) Nipper Spring (upper)
42126	7417	Thread, (looper, left hand) Pull-off
42127	7417	" (looper, right hand) Take-up
42130	7415	Lifting Lever for 42133 and 42144
42131	7415	" " Bracket for 42133 and 42144
42132	7415	Lifting Lever Spring for 42133 and 42144
42133	—	Foot Lifter complete, Nos. 1301D, 4885, 6439, 42130 to 42132 and two each 1148F, 1229c and 1547J
42134	7423	Throat Plate for 42109, for 81-52 Machine
42142	20777	Lifting Lever Connecting Rod for 42144
42143	20777	Rock Shaft complete for 42144, Nos. 2763, 2768, 6337, 7125 and two each 2770 and 12242
42144	—	Knee Lifter complete, Nos. 1301D, 42130 to 42132, 42142, 42143 and two each 1148F, 1229c and 1547J
42147	7406	Feed (back) Bar for 81-50 Machine
42148	7406	" " Connecting Link for 81-50 Machine
42149	7422	Feed (back) Dog, 3 teeth (16 teeth to the inch) for 42163, for 81-50 Machine
42150	7406	Feed (back) Regulator for 81-50 Machine
42151	7406	" (front) Bar with 1253c, for 81-50 Machine
42156	7410	Knife (stationary) Holder
42158	7422	Presser Foot Chaining-off Finger for 42265
42159	—	Presser Foot Plate (back) for 42265
42160	7424	" " " " Spring Adjusting Pin for 42265 and 42420
42163	7422	Throat Plate for 42149 and 42262, for 81-50 Machine
42165	7421	Feed Dog, 24 teeth (16 teeth to the inch) for 42171, for 81-52 Machine
42168	7421	Presser Foot Chaining-off Finger for 132646
42171	7421	Throat Plate for 42165, for 81-52 Machine
42213	7409	Knife (movable)
42214	7409	" " Gib for 132627
42244	7417	Thread (looper, right hand) Pull-off Eyelet
42253	7412	Needle Bar Bushing (lower) for 132522

NO.	PLATE	NAME
42262	7422	Feed (front) Dog, 21 teeth (16 teeth to the inch) for 42163, for 81-50 Machine
42263	— —	Presser Foot Plate (front) for 42265 and 42420
42264	— — —	Presser Foot Shank for 42265 and 42420
42265	7422	Presser Foot (spring hinged) complete, for medium knit material, for light sweater work, for 81-50 Machine, Nos. 233J, 464c, 9320, 14058, 42158 to 42160, 42263, 42264 and 42461
42288	7424	Presser Foot Chaining-off Finger for 42420
42405	— — —	Presser Foot Plate (back) for 42420
42418	— — —	Tension (looper, right hand) Screw Stud 828c, with 1560c
42420	7424	Presser Foot (spring hinged) complete, for light knit material such as silk, balbriggan underwear, etc., for 81-50 Machine, Nos. 233J, 464c, 9320, 14058, 42160, 42263, 42264, 42288, 42105 and 42461
42461	7424	Presser Foot Plate (front) Hinge Pin for 42265 and 42420
42483	7413	Needle Bar Thread Retainer Disc
42491	7424	Feed (front) Dog, 29 teeth (22 teeth to the inch) for 42493, for 81-50 Machine
42492	7424	Feed (back) Dog, 4 teeth (22 teeth to the inch) for 42493, for 81-50 Machine
42493	7424	Throat Plate for 42491 and 42492, for 81-50 Machine
44209	— — —	Tension (needle thread) Screw Stud 916c with 1560c
46548	7418	Bench Stand Cover Rest (felt) for 79768
50117c	7411	Looper (left hand) Set Screw for 132566
50148c	7414	Tension (looper, left hand) Screw Stud for 124687
50150c	7416	Cloth Plate Hinge Stud Set Screw
50200c	7413	Looper (right hand) and Spreader Lever Ball Stud Set Screw for 132572
50200c	7413	Needle Bar Crank (front) Set Screw for 132597
50253J	7407	Feed Eccentric Cover Screw for 132600
50253J	7407	" (front) Eccentric Cover Screw for 132600
51145c	7407	Feed Regulating Screw for 132534
51145c	7407	" (front) Regulating Screw for 132534

NO.	PLATE	NAME
51292c	7407	Feed Connecting Rod Hinge Screw for 81-52 Machine
51292c	7407	Feed (front) Connecting Rod Hinge Screw for 81-50 Machine
51576E	7419	Machine Base Screw Stud Nut for 132592
54477	7419	" " " " for 132592
54883	7414	Tension (looper, left hand) Spring
56864	5566	Chain Hook (large) for 6439
56865	7418	" " (small) for 6439
57076	7414	Tension looper, right hand) Thread Guide
62527	7420	Presser Foot Hinge Pin for 132613, 132633 and 132646
68350	7416	Arm Oil Cup
68547	7418	Wrench for 1324 and 1728 (Accessories)
79768	— — —	Bench Stand with 27998, two each 28291, 46548, wood screws 1½ in. No. 14 and eight wood screws 5/8 in. No. 5
120341	5566	Tweezers (curved) (Accessories)
120344	5566	Oiler (copper plated) with 120345 (Accessories)
120345	5566	Oiler Spout, 5 in. long, for 120344
120440	5566	Screw Driver (Accessories)
124687	— — —	Tension (looper, left hand) Screw Stud 50148c with 1560c
131019	20776	Machine Base Oil Pipe for 132592
131020	20776	" " " " Valve for 132592
*132522	— — —	Arm with 42253, 132580 and two each 462c, 624c and 132589
132524	20777	Cloth Plate with 132525, for 132527
*132525	— — —	" " Hinge Bracket for 132524
132526	7416	" " " Stud
132527	— — —	Cloth Plate complete, Nos. 42005, 42108, 132524, 132601, two 236c and five 233E
132528	7406	Feed Bar Hinge Pin for 81-52 Machine
132528	7406	" (front) Bar Hinge Pin for 81-50 Machine
132529	7407	Feed Connecting Rod with 171c, 1695J, 132530 and two 1057E, for 132619
132529	7407	Feed (front) Connecting Rod with 171c, 1695J, 132530 and two 1057E, for 132619
*132530	— — —	Feed Connecting Rod Cap for 132529
*132530	— — —	" (front) Connecting Rod Cap for 132529
*132531	— — —	Feed Eccentric for 132534

NO.	PLATE	NAME
*132531	—	Feed (front) Eccentric for 132534.....
*132532	—	“ Eccentric Body for 132534.....
*132532	—	“ (front) Eccentric Body for 132534
132533	7407	“ Eccentric Oil Tube for 132534....
132533	7407	“ (front) Eccentric Oil Tube for 132534.....
132534	7407	Feed Eccentric complete for 132619, Nos. 201, 19047, 51145c, 132531 to 132533, 132628 and two 1036c.....
132534	7407	Feed (front) Eccentric complete for 132619, Nos. 201, 19047, 51145c, 132531 to 132533, 132628 and two 1036c.....
132536	7408	Feed Eccentric Lubricator with 132537, for 81-52 Machine.....
132536	7408	Feed (front) Eccentric Lubricator with 132537, for 81-50 Machine.....
132537	7408	Feed Eccentric Lubricator Oil Wick (braided cotton) for 132536.....
132537	7408	Feed (front) Eccentric Lubricator Oil Wick (braided cotton) for 132536....
132539	7408	Feed Lifting Eccentric Connection for 132641.....
132539	7408	Feed (front) Lifting Eccentric Con- nection for 81-50 Machine.....
132540	7406	Feed (front) Rock Shaft for 132541....
132541	—	Feed (front) Rock Shaft complete for 81-50 Machine, Nos. 1444c, 42021 and 132540.....
132542	7408	Feed Rock Shaft Hinge Pin with 132544, for 81-52 Machine.....
132542	7408	Feed (front) Rock Shaft Hinge Pin with 132544, for 81-50 Machine.....
132543	7408	Feed Rock Shaft Hinge Pin Bushing for 81-52 Machine.....
132543	7408	Feed (front) Rock Shaft Hinge Pin Bushing for 81-50 Machine.....
132543	7408	Looper (right hand) and Spreader Lever Hinge Pin Bushing.....
132544	7408	Feed Rock Shaft Hinge Pin Bushing Oil Wick (braided cotton) for 81-52 Ma- chine.....
132544	7408	Feed (front) Rock Shaft Hinge Pin Bushing Oil Wick (braided cotton) for 81-50 Machine.....
132544	7408	Feed Rock Shaft Hinge Pin Oil Wick (braided cotton) for 132542.....

NO.	PLATE	NAME
132544	7408	Feed (front) Rock Shaft Hinge Pin Oil Wick (braided cotton) for 132542....
*132545	—	Frame.....
132546	20777	“ Bottom Cover with 132594.....
132547	20777	“ “ “ Gasket.....
132548	7416	“ Oil Cup.....
132549	20776	“ Rotary Shaft with 132558 and 132559, for 132616.....
132550	7416	Frame Rotary Shaft Bushing (front) with 132552.....
132551	7416	Frame Rotary Shaft Bushing (front) Oil Wick (braided cotton).....
132551	7416	Frame Rotary Shaft Flanged Bushing (back) Oil Wick (braided cotton)....
132552	7411	Frame Rotary Shaft Bushing (front) Oil Pad (braided cotton) for 132550
132552	7411	Looper (left hand) Lever Hinge Stud Oil Pad (braided cotton) for 132569..
132553	7408	Frame Rotary Shaft Crank with 1036c and 1375c, for 132617.....
132554	20776	Frame Rotary Shaft Flanged Bushing (back) with 132555, 132556 and 132603
132555	7415	Frame Rotary Shaft Flanged Bushing (back) Oil Pad, large (braided cotton) for 132554.....
132556	7416	Frame Rotary Shaft Flanged Bushing (back) Oil Pad, small (braided cotton) for 132554.....
132558	7415	Frame Rotary Shaft Oil Pad (braided cotton) for 132549.....
132559	7415	Frame Rotary Shaft Oil Pad Retainer for 132549.....
132560	20776	Frame Side Cover (left) with 19045....
132561	20777	“ Top Cover.....
132562	7410	Knife (movable) Lever with 175E.....
132563	7410	“ “ “ Connection with 132564 and two 1057E, for 132620....
*132564	—	Knife (movable) Lever Connection Cap for 132563.....
132565	7410	Knife (movable) Lever Connection Hinge Stud.....
132566	7411	Looper (left hand) Lever with 50117c and two 1253c.....
132567	7411	Looper (left hand) Lever Connecting Stud.....
132569	7411	Looper (left hand) Lever Hinge Stud with 132552.....

NO.	PLATE	NAME
132571	7411	Looper (left hand) Lever Hinge Stud Oil Wick (braided cotton).....
132572	7411	Looper (right hand) and Spreader Lever with 50200c.....
132573	7412	Looper (right hand) and Spreader Lever Ball Stud for 132617.....
132573	7412	Needle Bar Crank (back) Ball Stud for 132616.....
132574	7412	Looper (right hand) and Spreader Lever Connection with 132575, 132576 and four 1057E, for 132617.....
*132575	——	Looper (right hand) and Spreader Lever Connection Cap (lower) for 132574..
*132576	——	Looper (right hand) and Spreader Lever Connection Cap (upper) for 132574..
132577	7412	Looper (right hand) and Spreader Lever Connection Guide.....
132577	7412	Needle Bar Connecting Rod Guide.....
132578	7412	Looper (right hand) and Spreader Lever Hinge Pin with 132579.....
132579	7412	Looper (right hand) and Spreader Lever Hinge Pin Bushing Oil Wick (braided cotton).....
132579	7412	Looper (right hand) and Spreader Lever Hinge Pin Oil Pad (braided cotton) for 132578.....
132580	7412	Needle Bar Bushing (upper) for 132522
132581	7412	" " " " Oil Pad (braided cotton).....
132582	7412	Needle Bar Connecting Link for 132615
132583	7412	" " " " Hinge Pin with 132584, for 132615.....
132584	7412	Needle Bar Connecting Link Hinge Pin Oil Pad (wick) for 132583.....
132585	7413	Needle Bar Connecting Rod with 132586, 132587 and four 1057E, for 132616...
*132586	——	Needle Bar Connecting Rod Cap (lower) for 132585.....
*132587	——	Needle Bar Connecting Rod Cap (upper) for 132585.....
132588	7413	Needle Bar Crank (back) with 132590 and two 1259c.....
132589	7413	Needle Bar Crank (back) Bushing for 132522.....
132590	7413	Needle Bar Crank (back) Oil Pad (wick) for 132588.....
132591	7417	Thread (looper, right hand) Pull-off....

NO.	PLATE	NAME
132592	——	Machine Base complete, Nos. 131019, 131020, 132593, 132596, 132618, 132647, three each 9842, 51576E, 54477 and four each 935E, 42088 and 132595....
132593	7419	Machine Base Oil Drain Strainer for 132592.....
132594	7419	Machine Base Thumb Screw Bushing for 132546.....
132595	7419	Machine Base Cushion (large) felt, for 132592.....
132596	7419	Machine Base Cushion (leather) for 132592.....
132597	7413	Needle Bar Crank (front) with 620c, 1259c and 50200c, for 132615.....
132598	7412	Needle Bar Connecting Bracket with 187E and 223E, for 132615.....
132599	7414	Tension (looper, left hand) Thread Guide
132600	——	Frame Top Cover Extension Holder 42102 with 42101, 132650, 132651 and two each 190r and 50253r.....
132601	20777	Cloth Plate Extension (lower) for 132527
132602	7418	Machine Base Thumb Screw Washer (Accessories).....
132603	7415	Frame Rotary Shaft Flanged Bushing (back) Oil Pad Retainer for 132554..
132607	7420	Feed Dog, 34 teeth (22 teeth to the inch) for seaming rayon, for 132614.....
132608	7420	Presser Foot Chaining-off Finger for 132613.....
132609	——	Presser Foot Chaining-off Plate for 132613, 132633 and 132646.....
132610	7420	Presser Foot Chaining-off Plate Collar with 240c, for 132613, 132633 and 132646.....
132611	7420	Presser Foot Chaining-off Plate Collar Guide Pin for 132613, 132633 and 132646.....
132612	——	Presser Foot Shank with 735c, for 132613, 132633 and 132646.....
132613	7420	Presser Foot (spring hinged) complete, for rayon, Nos. 233r, 14058, 62527, 132608 to 132612 and 132648.....
132614	7420	Throat Plate for 132607.....
132615	——	Needle Bar Crank (front) 132597 with 132582, 132598 and two 132583.....

NO.	PLATE	NAME
132616	—	Frame Rotary Shaft 132549 with 132573 and 132585.....
132617	—	Looper (right hand) and Spreader Lever Connection 132574 with 132553 and 132573.....
132618	7419	Machine Base Cushion (small) felt, for 1407 or 1408, for 132592.....
132619	—	Feed Connecting Rod 132529 with 132534, for 81-52 Machine.....
132619	—	Feed (front) Connecting Rod 132529 with 132534, for 81-50 Machine.....
132620	—	Knife (movable) Lever Connection 132563 with 132649.....
132621	7412	Needle Bar Bushing (upper) Oil Pad Cover.....
132622	7417	Thread (needle) Eyelet.....
132623	7417	" " Take-up.....
132625	7415	Feed Rock Shaft for 132626.....
132626	—	Feed Rock Shaft complete for 81-52 Machine, Nos. 42021 and 132625.....
132627	—	Knife (movable) Holder 42035 with 133E, 42037, 42040, 42214 and two 404E.....
132628	7407	Feed Regulating Screw Washer for 132534.....
132628	7407	Feed (front) Regulating Screw Washer for 132534.....
132629	7417	Thread (looper, left hand) Eyelet.....
132630	7411	Looper (right hand).....
132631	7411	Spreader.....
132632	20776	Balance Wheel, 1 $\frac{7}{8}$ in. pulley, with 446c and 1285c.....
132633	7423	Presser Foot (spring hinged) complete, for plain work, for $\frac{1}{8}$ in. bight, for 81-52 Machine, Nos. 233I, 14058, 42118, 62527, 132609 to 132612 and 132648.....
132641	—	Feed Bar 42006 with 132539, for 81-52 Machine.....
132645	7411	Looper (left hand) Lever Connecting Stud Hinge Pin.....
132646	7421	Presser Foot (spring hinged) complete, for pants pockets, for $\frac{5}{32}$ in. to $\frac{7}{32}$ in. bight, for 81-52 Machine, Nos. 233I, 14058, 42168, 62527, 132609 to 132612 and 132648.....
132647	20777	Machine Base for 132592.....

NO.	PLATE	NAME
132648	—	Presser Foot Plate for 132613, 132633 and 132646.....
132649	7408	Feed Lifting Eccentric with two 462c, for 132620.....
132649	7408	Feed (front) Lifting Eccentric with two 462c, for 132620.....
132650	7409	Frame Top Cover Extension for 132600.....
132651	7407	Feed Eccentric Cover for 132600.....
132651	7407	" (front) Eccentric Cover for 132600.....
*150057	—	Thread Unwinder Thread Separator for 150058.....
150058	20778	Thread Unwinder Thread Separator 150057 with 150059, for 150061.....
*150059	—	Thread Unwinder Thread Separator Bracket for 150058.....
150060	20778	Thread Unwinder Thread Separator Bracket Arm with 164I and 9525, for 150061.....
150061	—	Thread Unwinder Thread Separator complete for 150178, Nos. 164I, 9525, 150058 and 150060.....
150178	20778	Thread Unwinder complete, for three spools, Nos. 150061, 201696I, 202490, 225257, 225259, 225324, 225326, 225388, and three each 150203, 225391 and wood screws $\frac{7}{8}$ in. No. 12.....
150203	—	Spool Rest Cushion (felt) for 150178.....
150209	—	Knife Grinder Knife Holder 41330 with 970b, 41331, 41332 and two each 313c, 771b, 1519I, 41333 and 41334, for 41335.....
200383c	7418	Thread Unwinder Spool Rest Rod Set Screw for 202490.....
201018c	7418	Thread Unwinder Spool Rest Set Screw for 225389 and 225395.....
201696I	7418	Thread Unwinder Thread Guide Lock Nut for 150178.....
202490	20778	Thread Unwinder Spool Stand with 200383c, for 150178.....
225257	20778	Thread Unwinder Spool Rest (for two spools) with 201018c, for 150178.....
225259	20778	Thread Unwinder Spool Rest (for one spool) with 201018c, for 150178.....
225322	7418	Thread Unwinder Thread Guide Rod Washer for 225324.....
225324	20778	Thread Unwinder Thread Guide Rod with 208E and 225322, for 150178.....

NUMERICAL LIST OF PARTS

NO.	PLATE	NAME
225326	7418	Thread Unwinder Thread Guide Position Cup for 150178.....
225388	20778	Thread Unwinder Spool Rest Rod for 150178.....
225390	7234	Thread Unwinder Thread Cone Holder, for inverted cones, for 150178.....
225391	20778	Thread Unwinder Thread Guide for 150178.....

Genuine Singer Needles should be used in this machine. Their containers are marked with the Company's Trade Mark "SIMANCO." 1

Needles in Containers marked "For Singer Machines" are not Singer made needles. 2

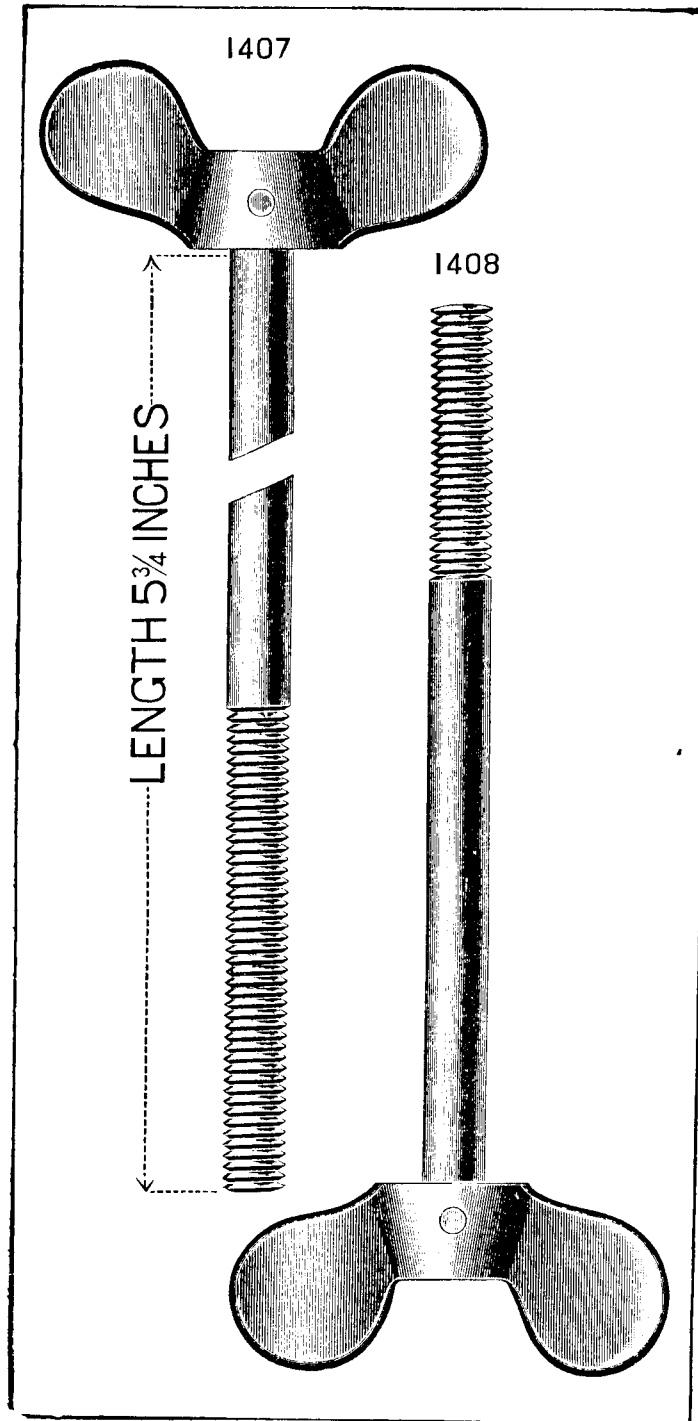
ILLUSTRATIONS OF PARTS

FOR

MACHINES

Nos. 81-50 and 81-52

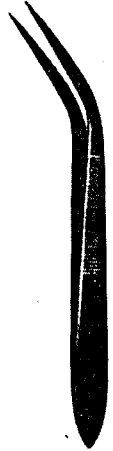
PLATE 5563—FULL SIZE



ILLUSTRATIONS OF PARTS
FOR
MACHINES
Nos. 81-20 and 81-22

PLATE 5566--ONE-HALF SIZE

120341



120344



120440 42090



120345



8908

42089

4822

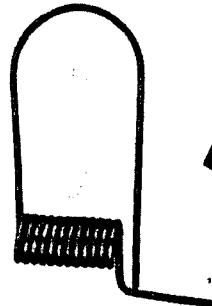


4883



4882

4879



56864



PLATE 5567--ONE-HALF SIZE

41329

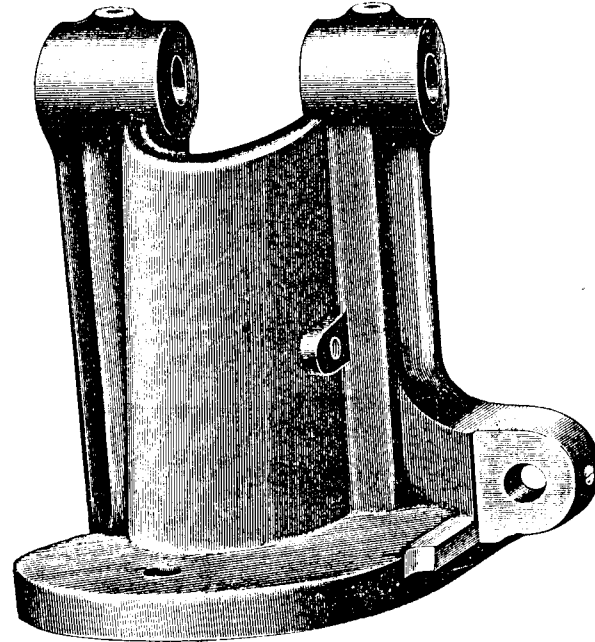


PLATE 5568—ONE-HALF SIZE

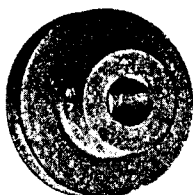
41327



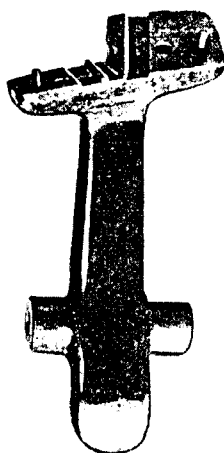
41326



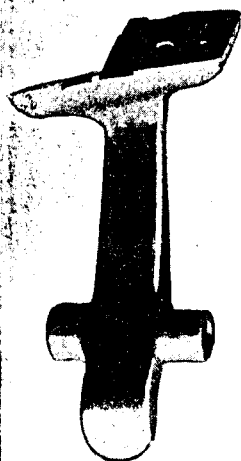
41328



41330



41818



41331

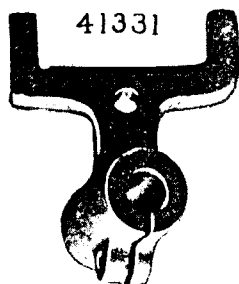
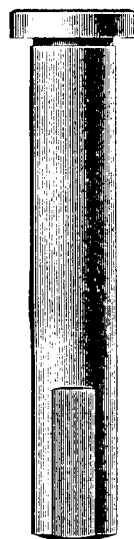
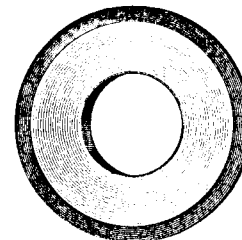


PLATE 5569—FULL SIZE

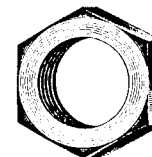
42065



41513



1508



157



878



1036



1520

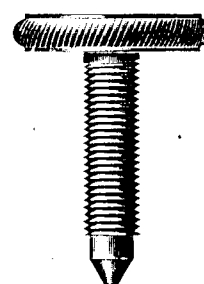


1519

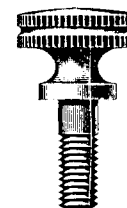
14222



970



771



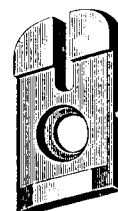
717



313



41333



41334



41332

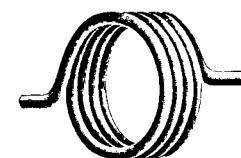


PLATE 7234—ONE-HALF SIZE

27739



225390

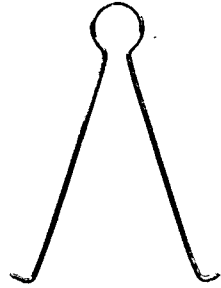
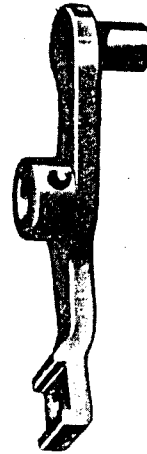


PLATE 7406—FULL SIZE

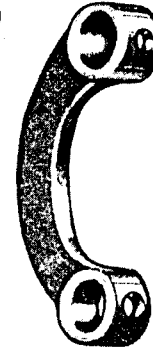
42147



61



42148



42150



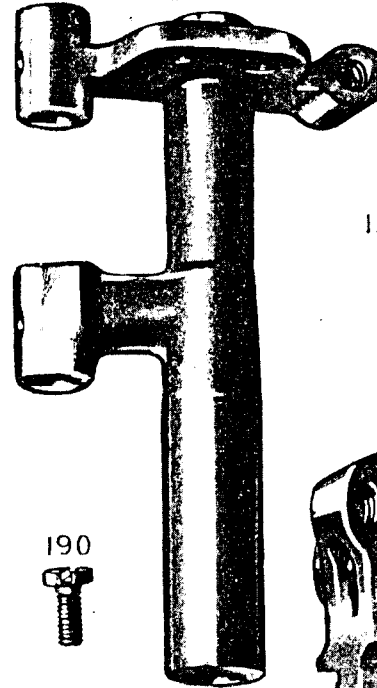
1132



42151



132540



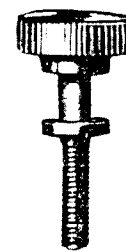
1253



190



1444



132528



PLATE 7407—FULL SIZE

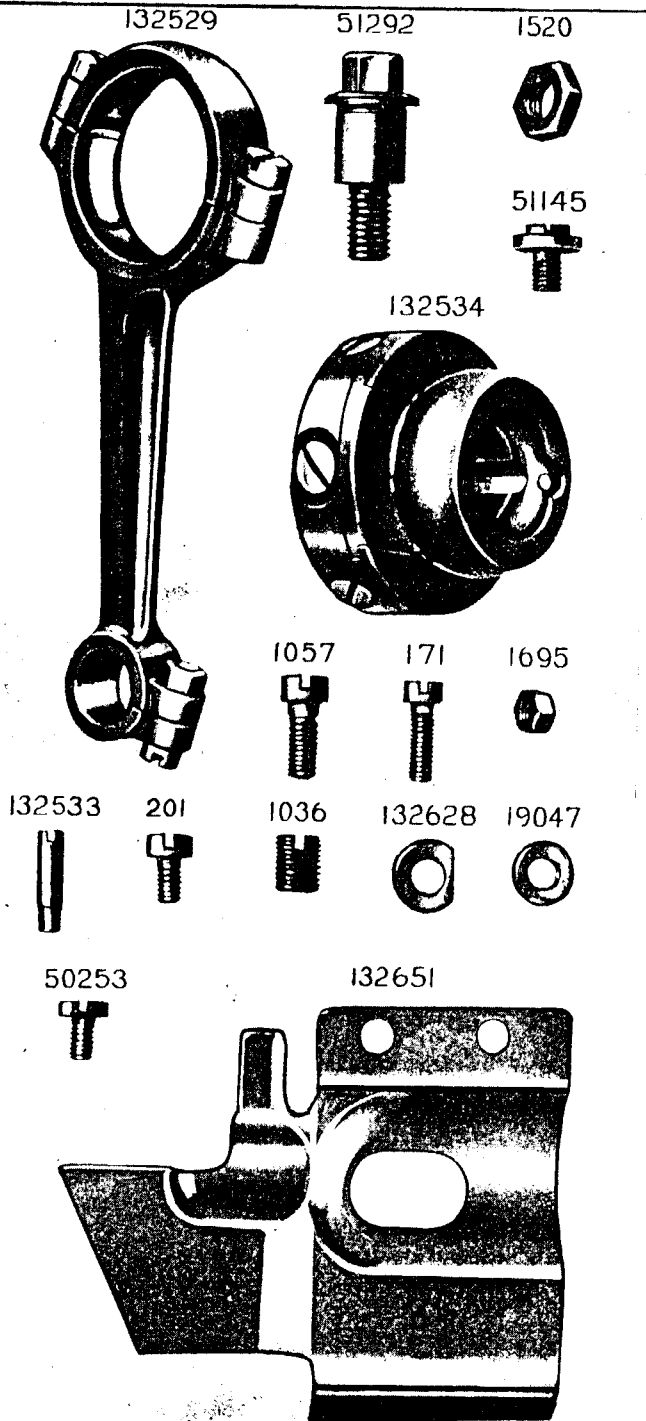


PLATE 7408—FULL SIZE

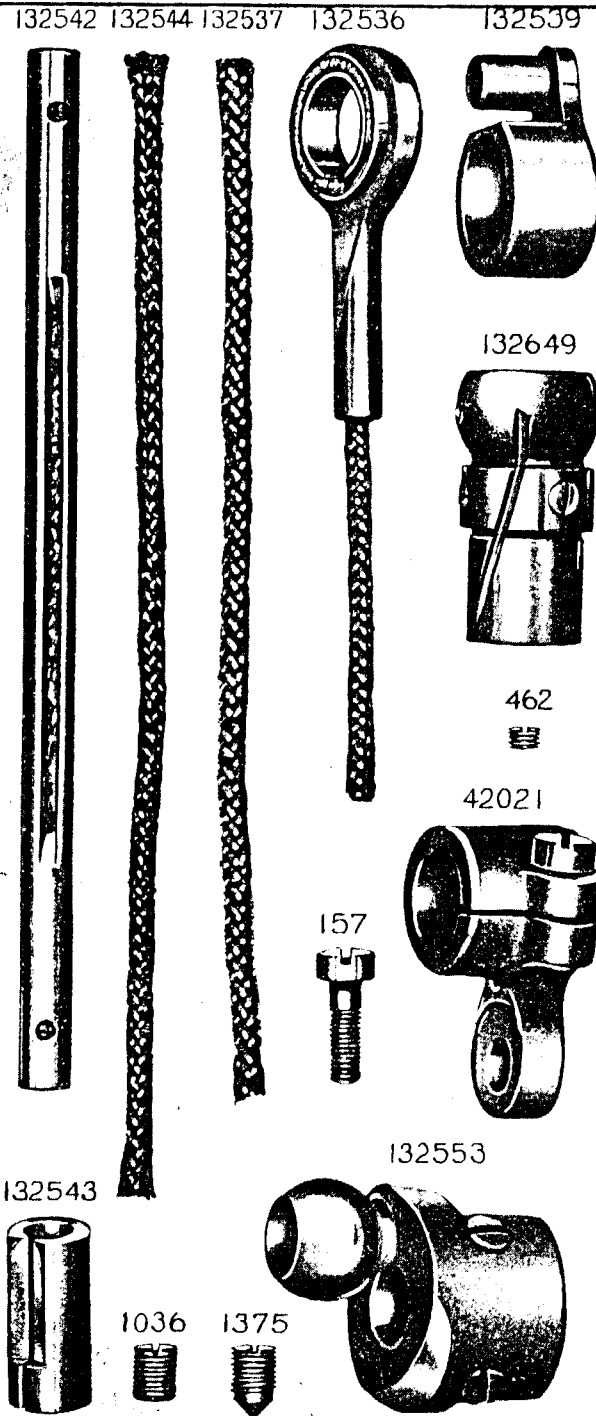


PLATE 7409—FULL SIZE

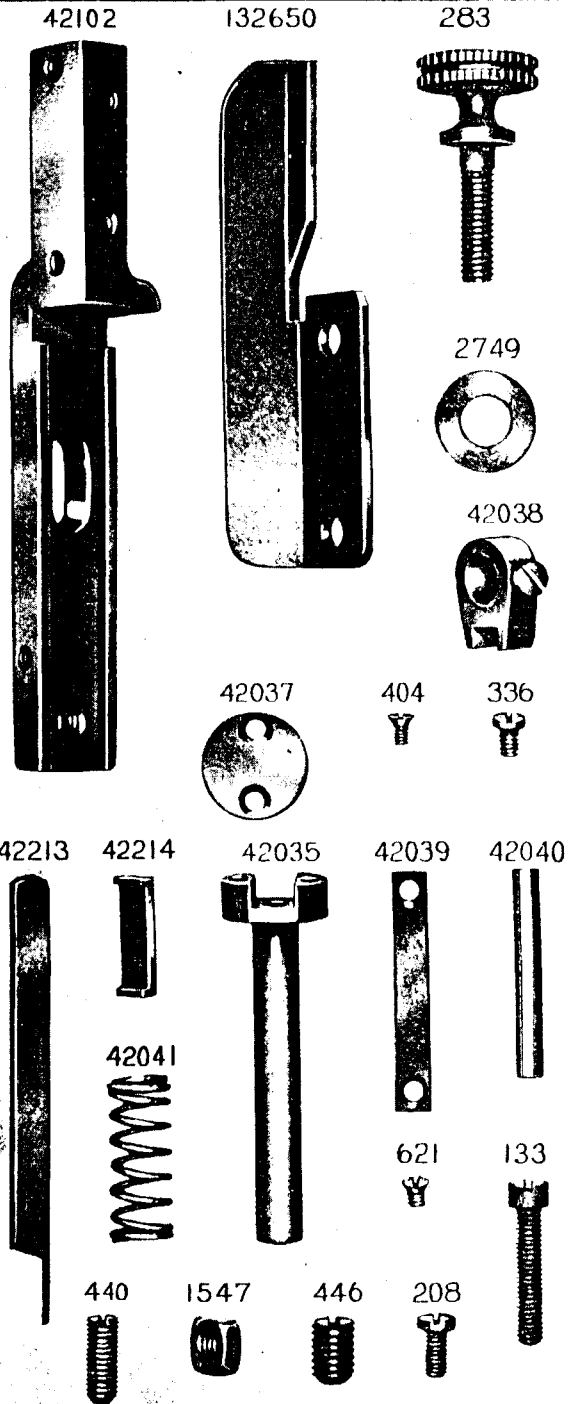


PLATE 7410—FULL SIZE

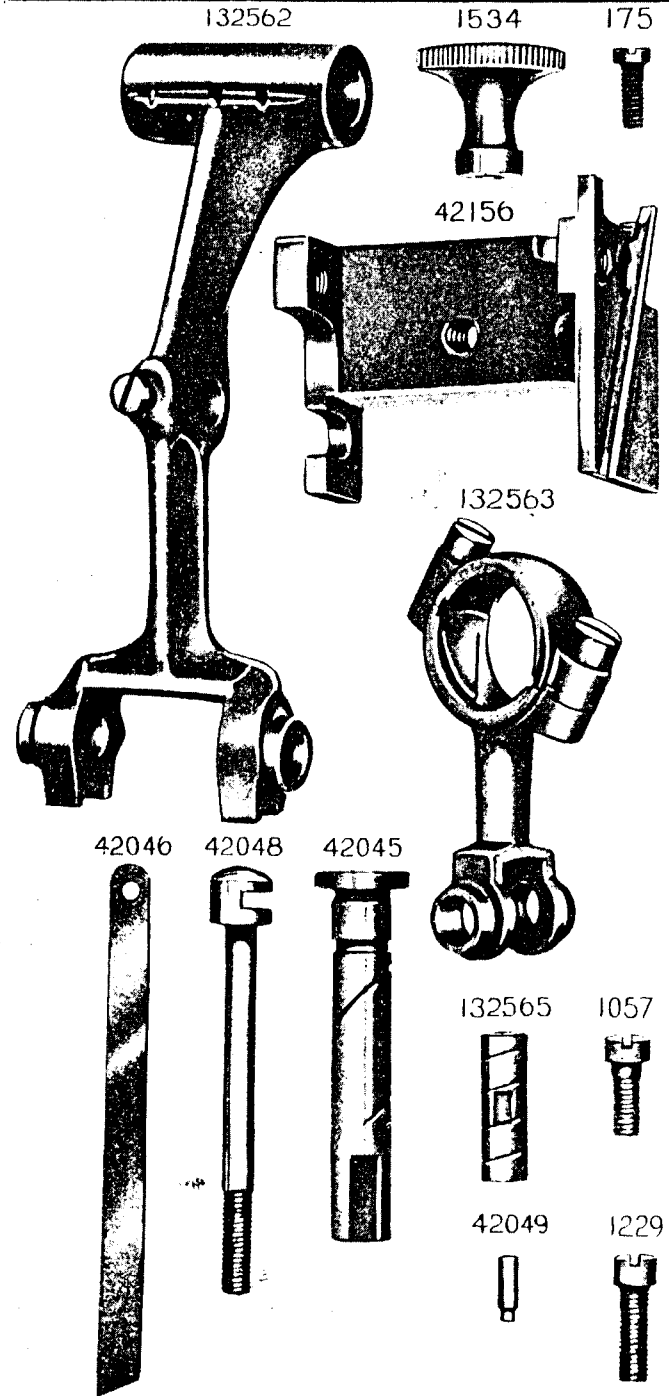


PLATE 7411—FULL SIZE

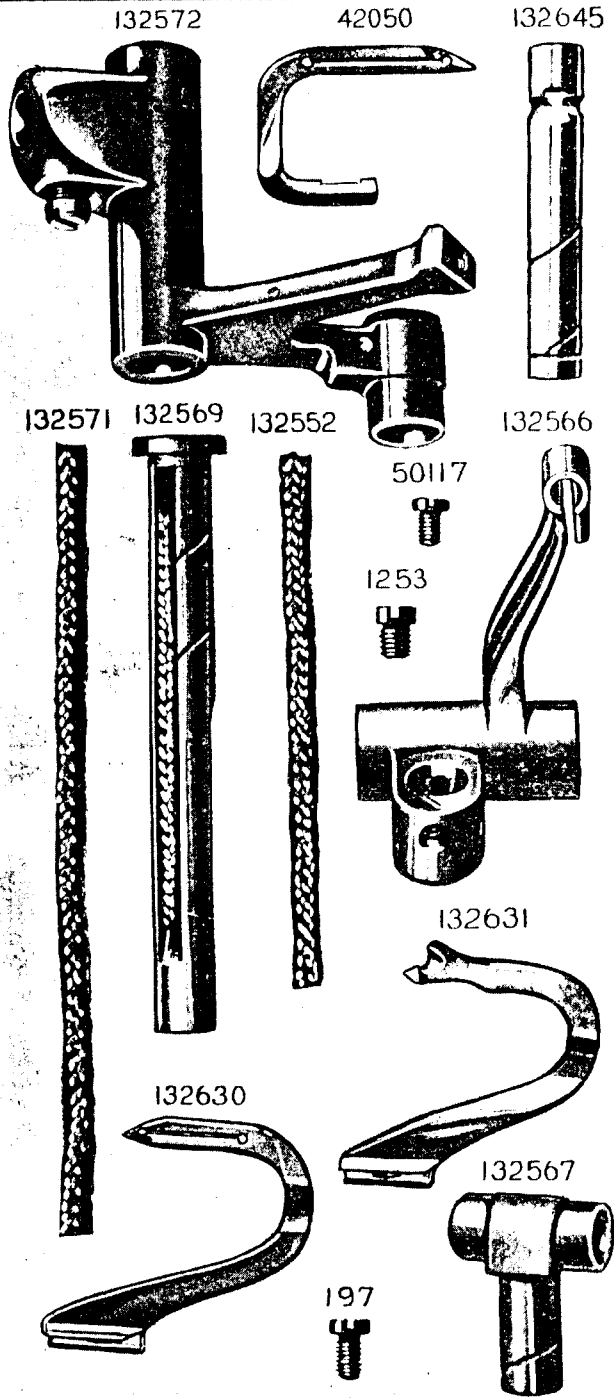


PLATE 7412—FULL SIZE

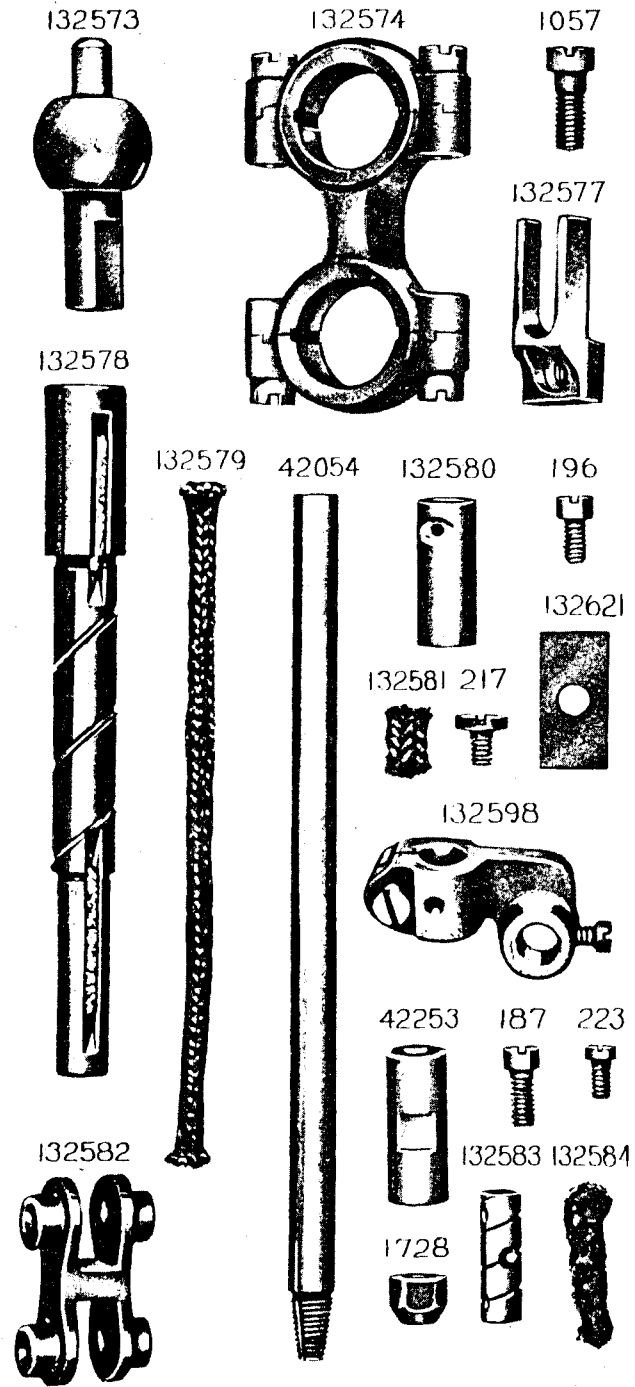


PLATE 7413—FULL SIZE

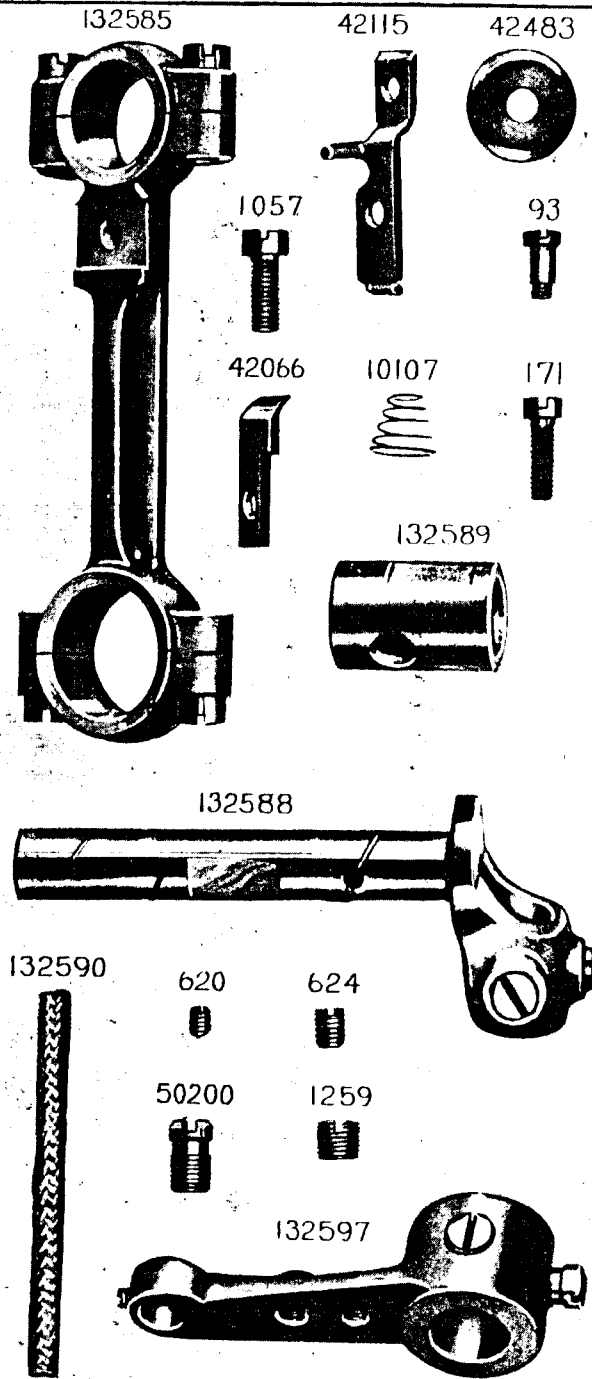


PLATE 7414—FULL SIZE

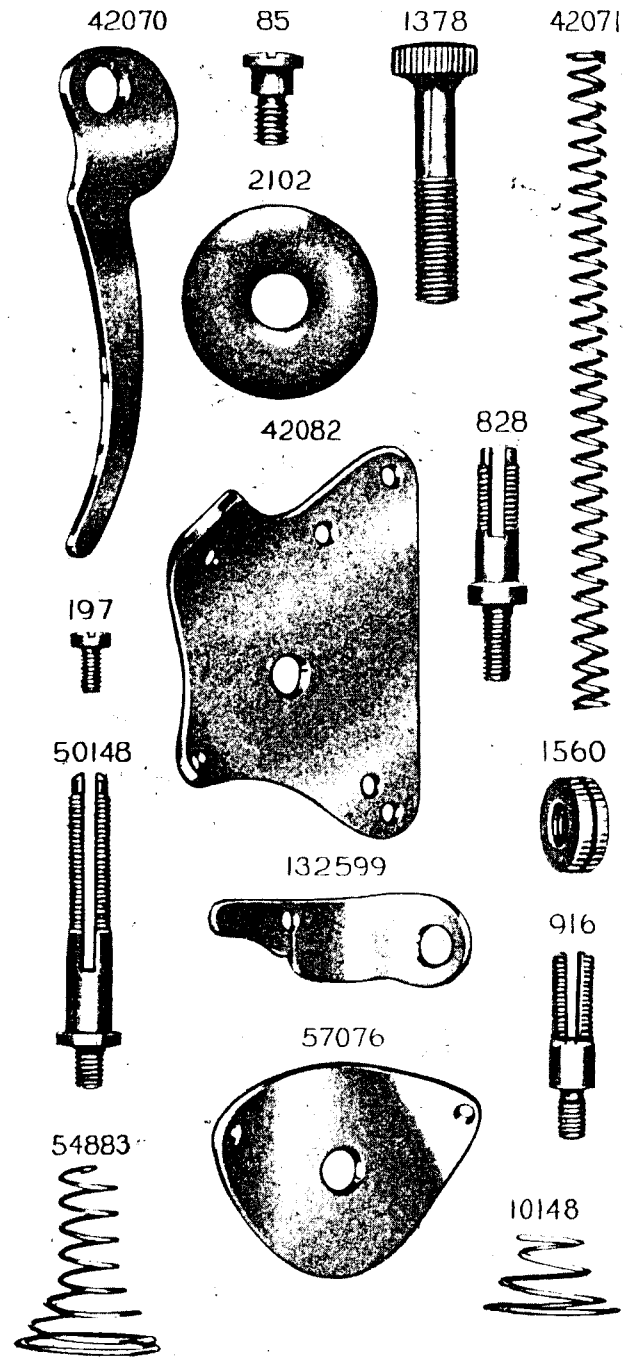


PLATE 7415—FULL SIZE

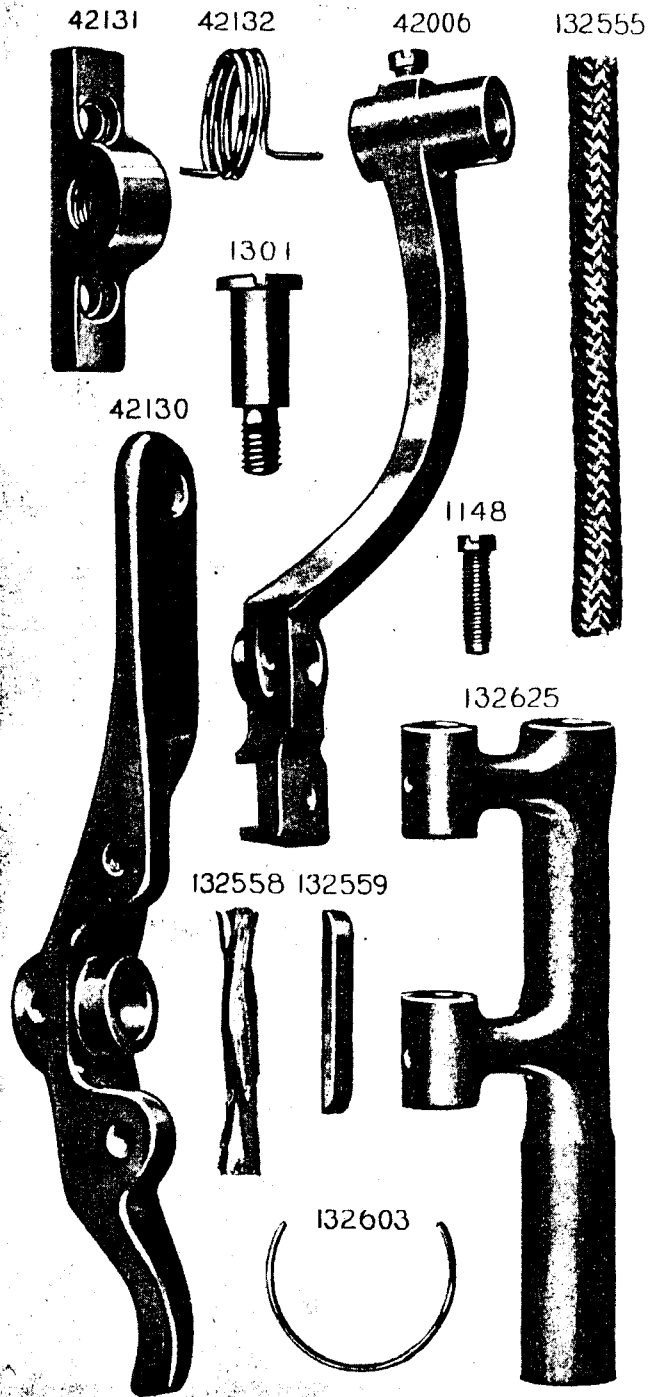


PLATE 7416—FULL SIZE

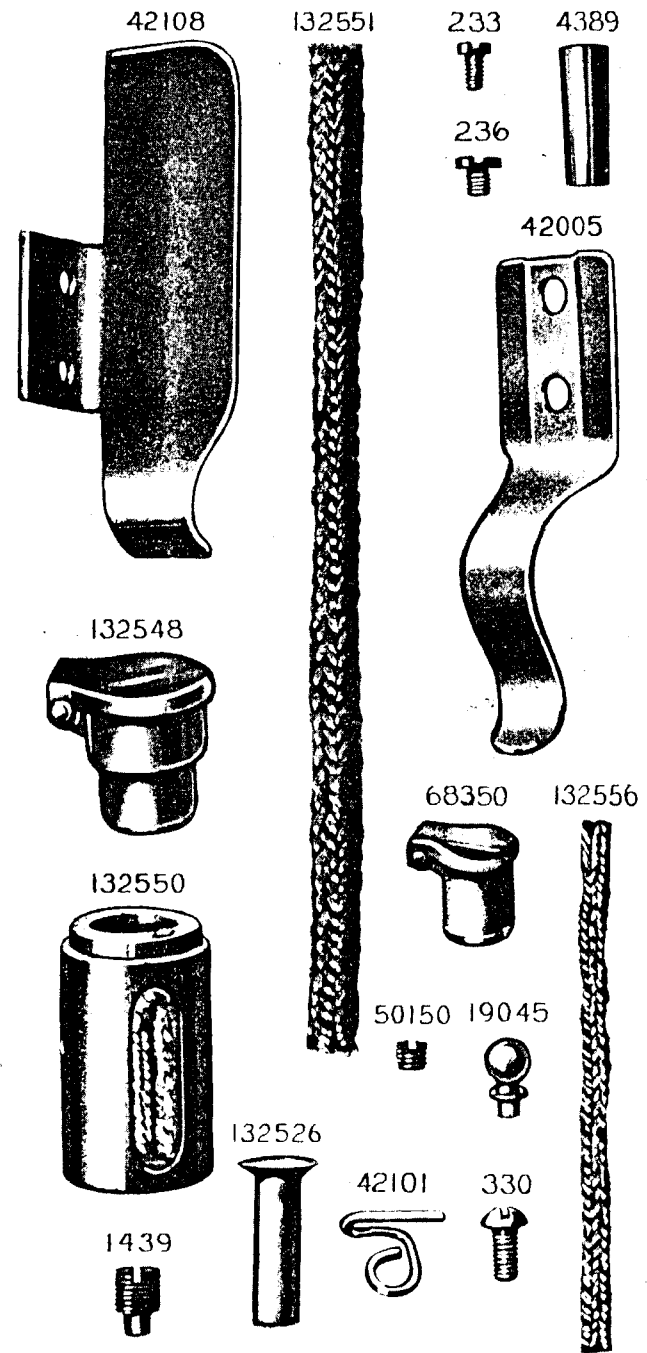


PLATE 7417—FULL SIZE

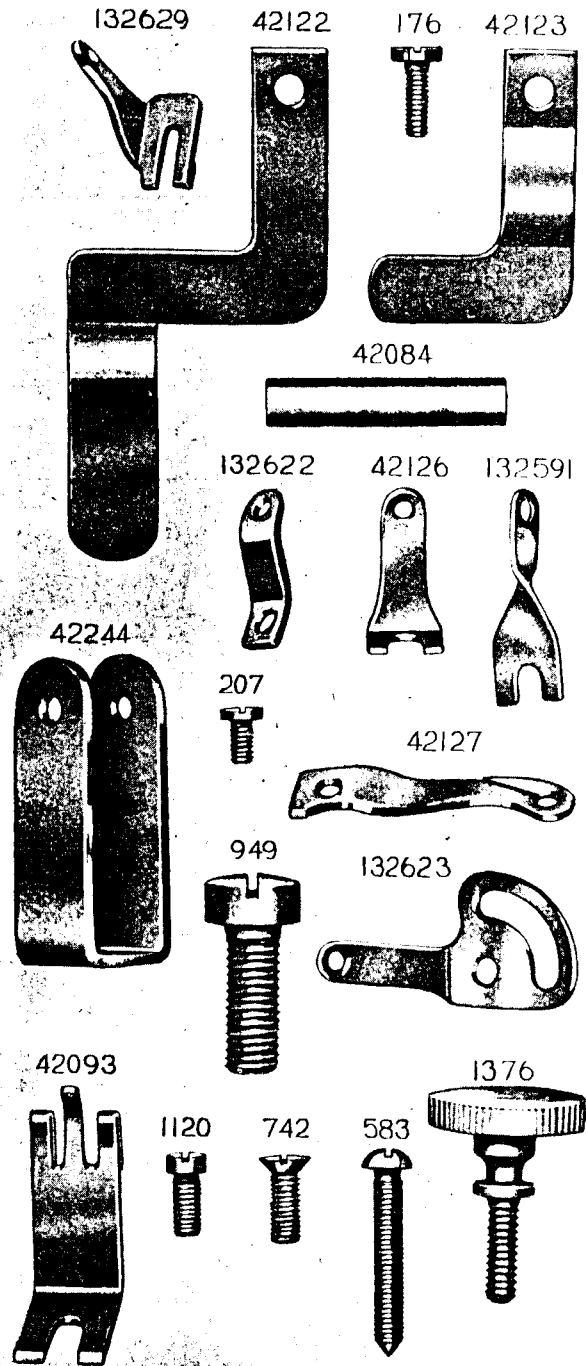


PLATE 7418—FULL SIZE

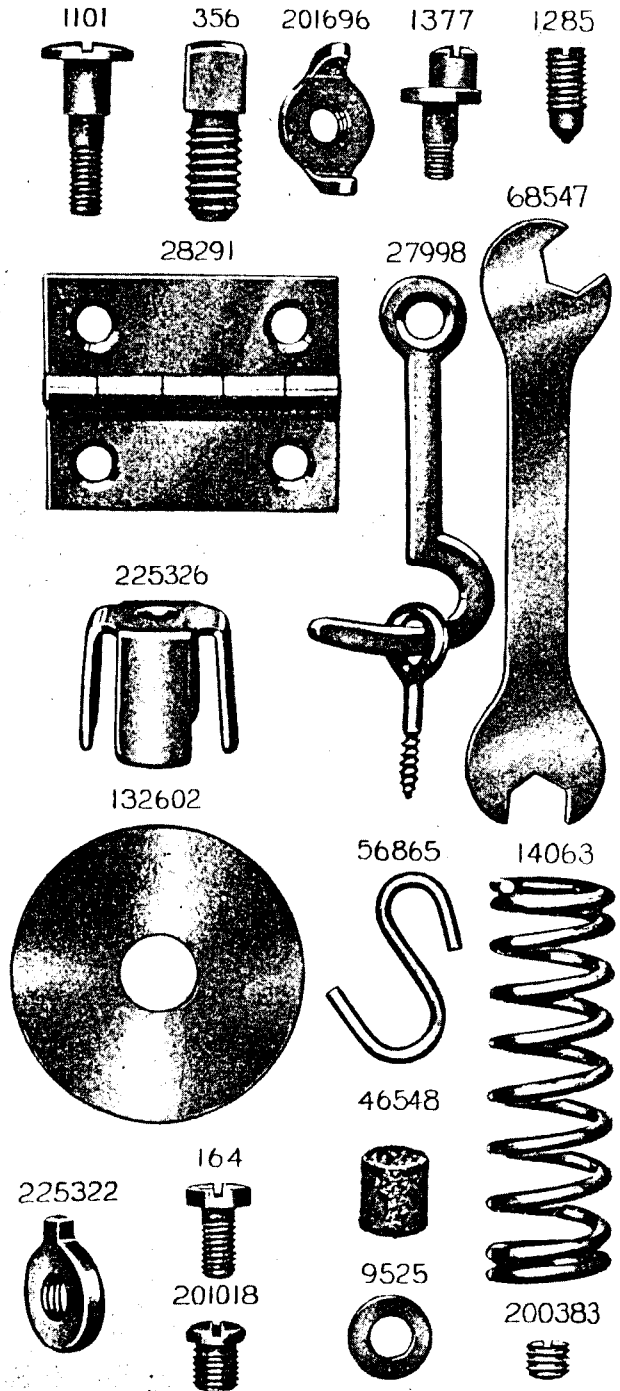
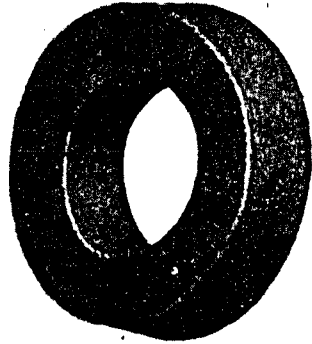


PLATE 7419—FULL SIZE

132596



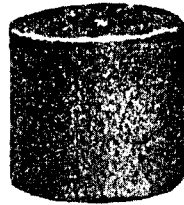
132595



132618



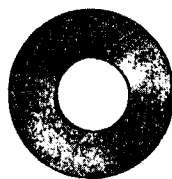
42088



51576



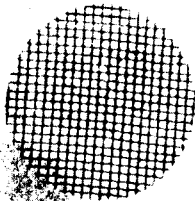
9842



54477



132593



935

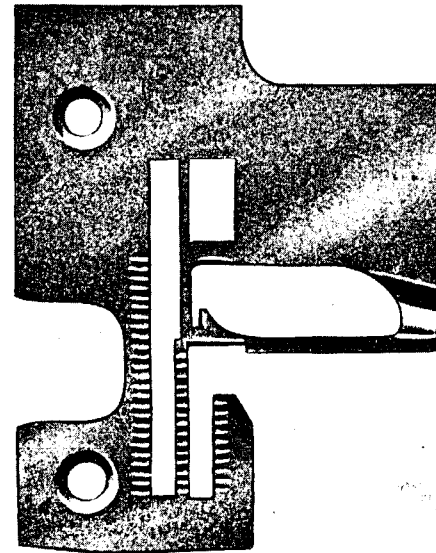


132594

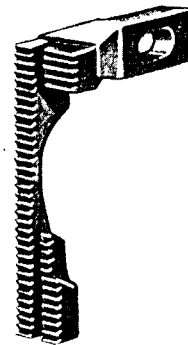


PLATE 7420—FULL SIZE

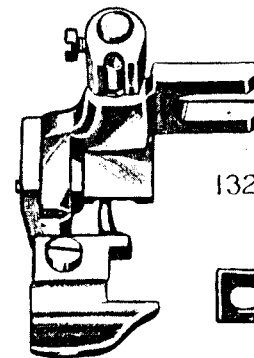
132614



132607



132613



132608



233



132610



132611



735



240



62527



14058



1324

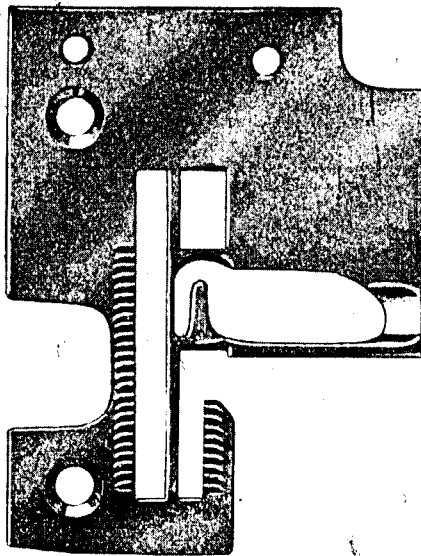


39541

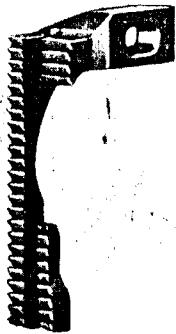


PLATE 7421—FULL SIZE

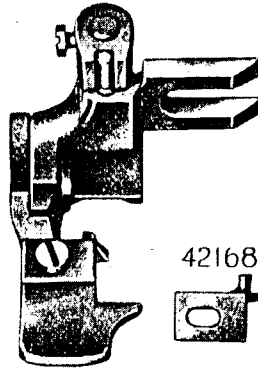
42171



42165



132646

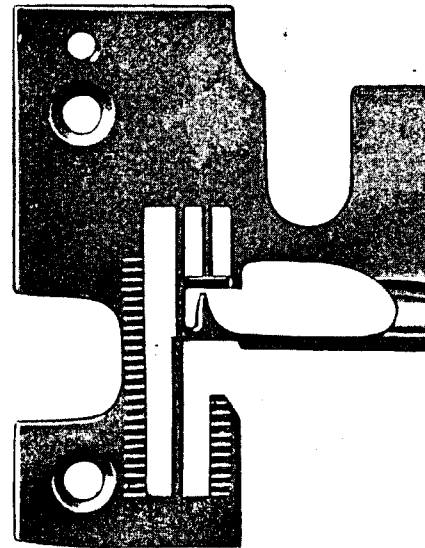


42168

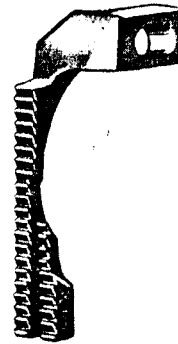


PLATE 7422—FULL SIZE

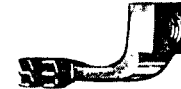
42163



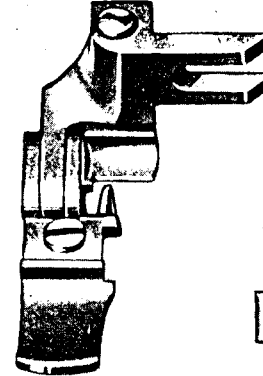
42262



42149



42265

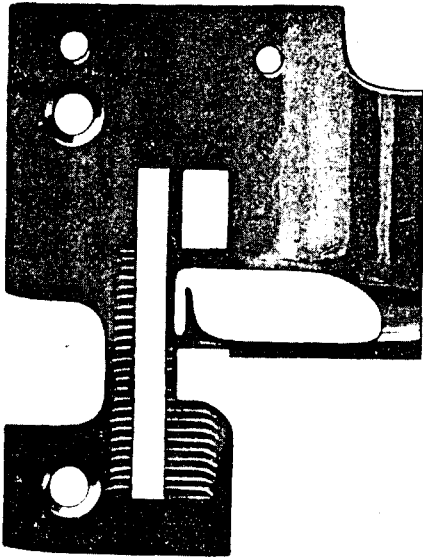


42158

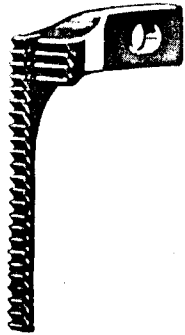


PLATE 7423—FULL SIZE

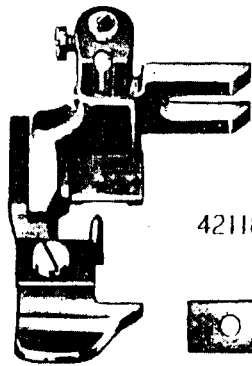
42134



42109



132633

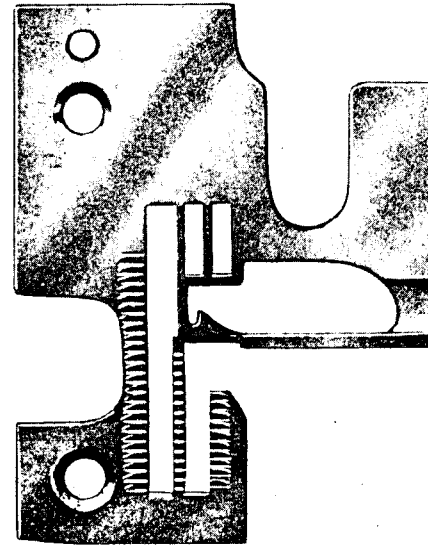


42118

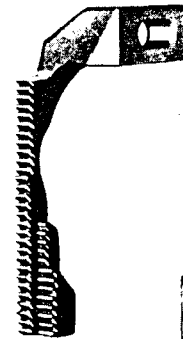


PLATE 7424—FULL SIZE

42493



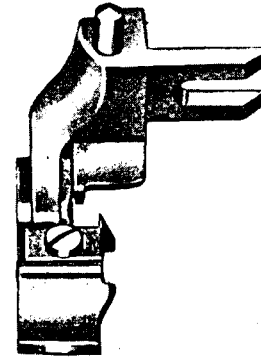
42491



42492



42420



42288



9320



42160



464



42461

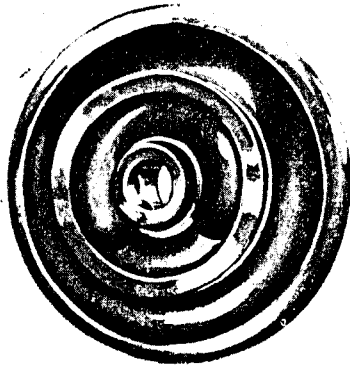


PLATE 20776—ONE-HALF SIZE

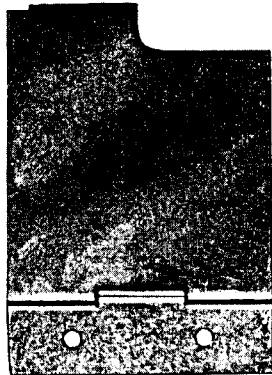
132560



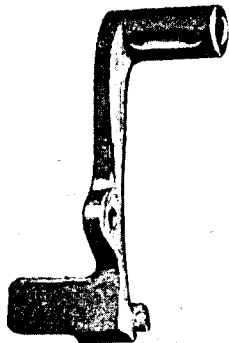
132632



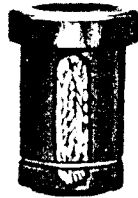
42028



42069



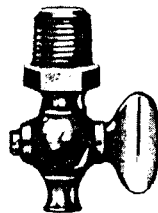
132554



131019



131020



132549

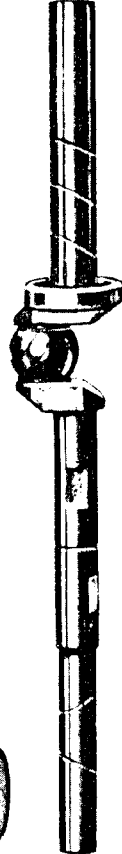
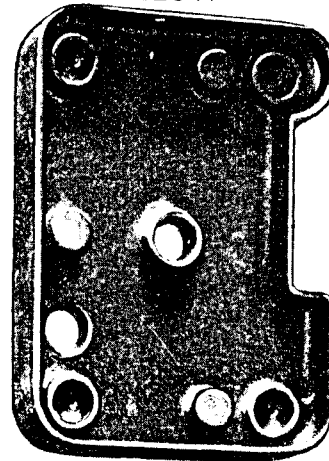
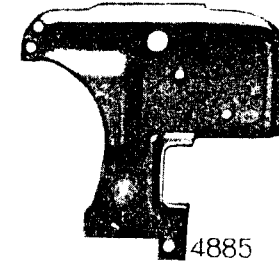


PLATE 20777—ONE-FOURTH SIZE

132647



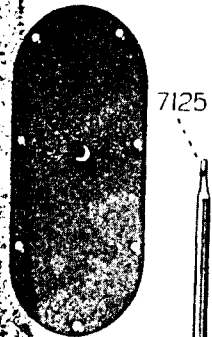
132561



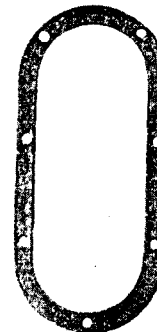
42142



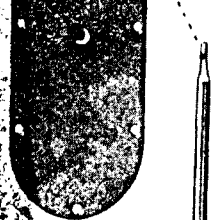
132546



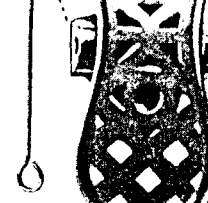
132547



7125



4884



42143



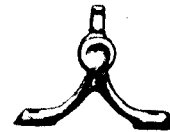
2770

6337

2763

2770

12242



2765

2766

132524



2767

132601

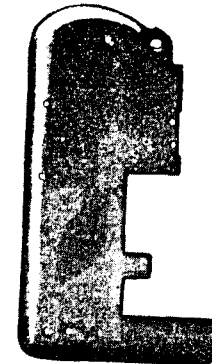
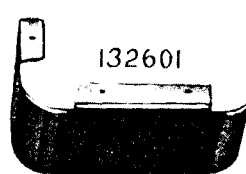


PLATE 20778—ONE-SIXTH SIZE

